VRV[®] Outdoor-Air Processing Unit

MODELS

Ceiling-mounted Duct type**FXMQ48MFVJU****FXMQ72MFVJU****FXMQ96MFVJU**

READ THESE INSTRUCTIONS CAREFULLY BEFORE INSTALLATION.
KEEP THIS MANUAL IN A HANDY PLACE FOR FUTURE REFERENCE.

LIRE SOIGNEUSEMENT CES INSTRUCTIONS AVANT L'INSTALLATION.
CONSERVER CE MANUEL A PORTEE DE MAIN POUR REFERENCE ULTERIEURE.

LEA CUIDADOSAMENTE ESTAS INSTRUCCIONES ANTES DE INSTALAR.
GUARDE ESTE MANUAL EN UN LUGAR A MANO PARA LEER EN CASO DE TENER
ALGUNA DUDA.

English

Français

Español

CONTENTS

1. SAFETY CONSIDERATIONS	1
2. BEFORE INSTALLATION.....	3
3. SELECTING INSTALLATION SITE	4
4. PREPARATIONS BEFORE INSTALLATION	5
5. UNIT INSTALLATION	5
6. REFRIGERANT PIPING	6
7. DRAIN PIPING WORK.....	7
8. INSTALLING THE DUCT	8
9. ELECTRIC WIRING WORK.....	8
10. WIRING EXAMPLE AND HOW TO SET THE REMOTE CONTROLLER	9
11. FIELD SETTING	11
12. TEST OPERATION	12

1. SAFETY CONSIDERATIONS





Read these “SAFETY CONSIDERATIONS for Installation” carefully before installing air conditioning equipment. After completing the installation, make sure that the unit operates properly during the startup operation.

Instruct the customer on how to operate and maintain the unit. Inform customers that they should store this Installation Manual with the Operation Manual for future reference.

Always use a licensed installer or contractor to install this product. Improper installation can result in water or refrigerant leakage, electrical shock, fire, or explosion.

Meanings of **DANGER**, **WARNING**, **CAUTION**, and **NOTE**

Symbols:

-  **DANGER**Indicates an imminently hazardous situation which, if not avoided, will result in death or serious injury.
-  **WARNING**Indicates a potentially hazardous situation which, if not avoided, could result in death or serious injury.
-  **CAUTION**Indicates a potentially hazardous situation which, if not avoided, may result in minor or moderate injury. It may also be used to alert against unsafe practices.
-  **NOTE**Indicates situations that may result in equipment or property-damage accidents only.

DANGER

- Refrigerant gas is heavier than air and replaces oxygen. A massive leak can lead to oxygen depletion, especially in basements, and an asphyxiation hazard could occur leading to serious injury or death.
- Do not ground units to water pipes, gas pipes, telephone wires, or lightning rods as incomplete grounding can cause a severe shock hazard resulting in severe injury or death. Additionally, grounding to gas pipes could cause a gas leak and potential explosion causing severe injury or death.

- If refrigerant gas leaks during installation, ventilate the area immediately. Refrigerant gas may produce toxic gas if it comes in contact with fire. Exposure to this gas could cause severe injury or death.
- After completing the installation work, check that the refrigerant gas does not leak throughout the system.
- Do not install unit in an area where flammable materials are present due to risk of explosions that can cause serious injury or death.
- Safely dispose all packing and transportation materials in accordance with federal/state/local laws or ordinances. Packing materials such as nails and other metal or wood parts, including plastic packing materials used for transportation may cause injuries or death by suffocation.

WARNING

- Only qualified personnel must carry out the installation work. Installation must be done in accordance with this installation manual. Improper installation may result in water leakage, electric shock, or fire.
- When installing the unit in a small room, take measures to keep the refrigerant concentration from exceeding allowable safety limits. Excessive refrigerant leaks, in the event of an accident in a closed ambient space, can lead to oxygen deficiency.
- Use only specified accessories and parts for installation work. Failure to use specified parts may result in water leakage, electric shocks, fire, or the unit falling.
- Install the air conditioner on a foundation strong enough that it can withstand the weight of the unit. A foundation of insufficient strength may result in the unit falling and causing injuries.
- Take into account strong winds, typhoons, or earthquakes when installing. Improper installation may result in the unit falling and causing accidents.
- Make sure that a separate power supply circuit is provided for this unit and that all electrical work is carried out by qualified personnel according to local state, and national regulations. An insufficient power supply capacity or improper electrical construction may lead to electric shocks or fire.
- Make sure that all wiring is secured, that specified wires are used, and that no external forces act on the terminal connections or wires. Improper connections or installation may result in fire.
- When wiring, position the wires so that the electrical components box lid can be securely fastened. Improper positioning of the electrical components box lid may result in electric shocks, fire, or the terminals overheating.
- Before touching electrical parts, turn off the unit.
- Be sure to install a ground fault circuit interrupter if one is not already available. This helps prevent electrical shocks or fire.

- Securely fasten the outside unit terminal cover (panel). If the terminal cover/panel is not installed properly, dust or water may enter the outside unit causing fire or electric shock.
- When installing or relocating the system, keep the refrigerant circuit free from substances other than the specified refrigerant (R-410A) such as air. Any presence of air or other foreign substance in the refrigerant circuit can cause an abnormal pressure rise or rupture, resulting in injury.
- Do not change the setting of the protection devices. If the pressure switch, thermal switch, or other protection device is shorted and operated forcibly, or parts other than those specified by Daikin are used, fire or explosion may occur.

⚠ CAUTION

- Do not touch the switch with wet fingers. Touching a switch with wet fingers can cause electric shock.
- Do not allow children to play on or around the unit to prevent injury.
- Do not touch the refrigerant pipes during and immediately after operation as the refrigerant pipes may be hot or cold, depending on the condition of the refrigerant flowing through the refrigerant piping, compressor, and other refrigerant cycle parts. Your hands may suffer burns or frostbite if you touch the refrigerant pipes. To avoid injury, give the pipes time to return to normal temperature or, if you must touch them, be sure to wear proper gloves.
- Heat exchanger fins are sharp enough to cut. To avoid injury wear glove or cover the fins when working around them.
- Install drain piping to proper drainage. Improper drain piping may result in water leakage and property damage.
- Insulate piping to prevent condensation.
- Be careful when transporting the product.
- Do not turn off the power immediately after stopping operation. Always wait for at least 5 minutes before turning off the power. Otherwise, water leakage may occur.
- Do not use a charging cylinder. Using a charging cylinder may cause the refrigerant to deteriorate.
- Refrigerant R-410A in the system must be kept clean, dry, and tight.
 - (a) Clean and Dry -- Foreign materials (including mineral oils such as SUNISO oil or moisture) should be prevented from getting into the system.
 - (b) Tight -- R-410A does not contain any chlorine, does not destroy the ozone layer, and does not reduce the earth's protection against harmful ultraviolet radiation. R-410A can contribute to the greenhouse effect if it is released. Therefore take proper measures to check for the tightness of the refrigerant piping installation. Read the chapter Refrigerant Piping and follow the procedures.
- Since R-410A is a blend, the required additional refrigerant must be charged in its liquid state. If the refrigerant is charged in a state of gas, its composition can change and the system will not work properly.

- The indoor unit is for R-410A. See the catalog for indoor models that can be connected. Normal operation is not possible when connected to other units.
- Remote controller (wireless kit) transmitting distance can be shorter than expected in rooms with electronic fluorescent lamps (inverter or rapid start types). Install the indoor unit far away from fluorescent lamps as much as possible.
- Indoor units are for indoor installation only. Outdoor units can be installed either outdoors or indoors.
- Do not install the air conditioner in the following locations:
 - (a) Where a mineral oil mist or oil spray or vapor is produced, for example, in a kitchen.
Plastic parts may deteriorate and fall off or result in water leakage.
 - (b) Where corrosive gas, such as sulfurous acid gas, is produced.
Corroding copper pipes or soldered parts may result in refrigerant leakage.
 - (c) Near machinery emitting electromagnetic waves.
Electromagnetic waves may disturb the operation of the control system and cause the unit to malfunction.
 - (d) Where flammable gas may leak, where there is carbon fiber, or ignitable dust suspension in the air, or where volatile flammables such as thinner or gasoline are handled. Operating the unit in such conditions can cause a fire.
- Take adequate measures to prevent the outside unit from being used as a shelter by small animals. Small animals making contact with electrical parts can cause malfunctions, smoke, or fire. Instruct the customer to keep the area around the unit clean.

⚠ NOTE

- Install the power supply and control wires for the indoor and outdoor units at least 3.5 feet away from televisions or radios to prevent image interference or noise. Depending on the radio waves, a distance of 3.5 feet may not be sufficient to eliminate the noise.
- Dismantling the unit, treatment of the refrigerant, oil and additional parts must be done in accordance with the relevant local, state, and national regulations.
- Do not use the following tools that are used with conventional refrigerants: gauge manifold, charge hose, gas leak detector, reverse flow check valve, refrigerant charge base, vacuum gauge, or refrigerant recovery equipment.
- If the conventional refrigerant and refrigerator oil are mixed in R-410A, the refrigerant may deteriorate.
- This air conditioner is an appliance that should not be accessible to the general public.
- The wall thickness of field-installed pipes should be selected in accordance with the relevant local, state, and national regulations.

2. BEFORE INSTALLATION





- When moving the unit while removing it from the packing case, be sure to lift it by holding on to the four lifting lugs without exerting any pressure on other parts, especially, the refrigerant pipe and drain socket.
- Be sure to check the type of R410A refrigerant to be used before installing the unit. (Using an incorrect refrigerant will prevent normal operation of the unit.)
- The accessories needed for installation must be retained in your custody until the installation work is completed. Do not discard them!
- Decide upon a line of transport.
- Leave the unit inside its packing case while moving, until reaching the installation site. Where unpacking is unavoidable, use a sling of soft material or protective plates together with a rope when lifting, to avoid damage or scratch to the unit.
- For the installation of an outdoor unit, refer to the installation manual attached to the outdoor unit.
- Do not install or operate the unit in the place mentioned below.
 - **Laden with mineral oil, or filled with oil vapor or spray like in kitchens. (Plastic parts may deteriorate which could eventually cause the unit to fall out of place, or could lead to leaks.)**
 - **Where corrosive gas like sulfurous gas exists. (Copper tubing and brazed spots may corrode which could eventually lead to refrigerant leaks.)**
 - **Where exposed to combustible gas and where volatile liquid like thinner or gasoline is used. (Gas in the vicinity of the unit could ignite.)**
 - **Where machines can generate electromagnetic waves. (Control system may malfunction.)**
 - **Where the air contains high levels of salt such as that near the ocean and where voltage fluctuates greatly such as that in factories.**
Also in vehicles or vessels.
- This unit, both indoor and outdoor, is suitable for installation in a commercial and light industrial environment.
If install as a household appliance it may cause electromagnetic interference.

2-1 PRECAUTIONS

- Be sure to read this manual before installing the unit.
- Entrust installation to the place of purchase or a qualified serviceman. Improper installation could lead to leaks and, in worse cases, electric shock or fire.
- Use only parts provided with the unit or parts satisfying required specifications. Unspecified parts could cause the unit to fall out of place, or could lead to leaks and, in worse cases, electric shock or fire.
- Be sure to mount an air filter (part to be procured in the field) in the suction air passage in order to prevent water leaking, etc.

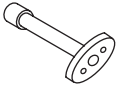
2-2 ACCESSORIES

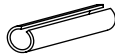
Check the following accessories are included with your unit. (Accessories are placed in the air outlet of unit.)

Name	Attached pipe	Insulation tube	Insulation for fitting
Quantity	1	2 pcs.	1 each
Shape	1)  (Only FXMQ72-96MFVJU)	2) 	3) for liquid pipe  Inside diameter $\phi 1$ 4) for gas pipe  Inside diameter $\phi 1-1/4$ (Only FXMQ48MFVJU)

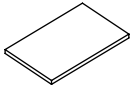
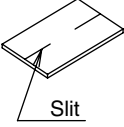
Name	Sealing pad	Sealing pad
Quantity	1	4
Shape	5)  (Only FXMQ48MFVJU)	6)  Slit

(Others)

- 7) Spring washer (M10)
(2 pcs. only for FXMQ72-96MFVJU)
- 8) Hexagon head bolt (M10 × 1-9/16)
(2 pcs. only for FXMQ72-96MFVJU)
- 9) Screws for flange connection (M5)
(16 pcs. for FXMQ48MFVJU, 28 pcs. for FXMQ72-96MFVJU)
- 10) Washers (8 pcs.)
- 11) Clamps (10 pcs.)
- 12) Installation manual
- 13) Operation manual

2-3 OPTIONAL ACCESSORIES

- A wired remote controller is necessary for this unit separately.

NOTE

- If you wish to use a remote controller that is different from the above, select a suitable remote controller after consulting catalogs and technical materials.

FOR THE FOLLOWING ITEMS, TAKE SPECIAL CARE DURING CONSTRUCTION AND CHECK AFTER INSTALLATION IS FINISHED.

a. Items to be checked after completion of work

Items to be checked	If not properly done, what is likely to occur.	Check
Are the indoor and outdoor unit fixed firmly?	The units may drop, vibrate or make noise.	
Is the gas leak test finished?	It may result in insufficient cooling.	
Is the unit fully insulated?	Condensate water may drip.	
Does drainage flow smoothly?	Condensate water may drip.	
Does the power supply voltage correspond to that shown on the name plate?	The unit may malfunction or the components burn out.	
Are wiring and piping correct?	The unit may malfunction or the components burn out.	
Is the unit safely grounded?	It may result in electric shocks.	
Is wiring size according to specifications?	The unit may malfunction or the components burn out.	
Is something blocking the air outlet or inlet of either the indoor or outdoor units?	It may result in insufficient cooling.	
Are refrigerant piping length and additional refrigerant charge noted down?	The refrigerant charge in the system is not clear.	

Also review the "SAFETY CONSIDERATIONS"

b. Items to be checked at time of delivery

Items to be checked	Check
Did you explain about operations while showing the instruction manual to your customer?	
Did you hand the instruction manual over to your customer?	

c. Points for explanation about operations

The items with **⚠ WARNING** and **⚠ CAUTION** marks in the instruction manual are the items pertaining to possibilities for bodily injury and material damage in addition to the general usage of the product. Accordingly, it is necessary that you make a full explanation about the described contents and also ask your customers to read the instruction manual.

2-4 NOTE TO INSTALLER

- Be sure to instruct customers how to properly operate the unit (especially cleaning filters, operating different functions, and adjusting the temperature) by having them carry out operations themselves while looking at the manual.
- Do not use in seaside locations with a lot of salt in the air, factories and other locations where the voltage fluctuates, in automobiles, or in marine vessels.

3. SELECTING INSTALLATION SITE

When it may exceed 86°F and RH80% in the ceiling or fresh air is inducted into the ceiling, an additional insulation (Thickness 3/8in. or more of glasswool or polyethylene form) is required.

- (1) Select an installation site where the following conditions are fulfilled and that meets with your customer's approval.
 - Where is resistible against weight of the unit.
 - In the upper space (including the back of the ceiling) of the unit where there is no possible dripping of water from the refrigerant pipe, drain pipe, water pipe, etc.
 - Where optimum air distribution can be ensured.
 - Where nothing blocks the air passage.
 - Where condensate can be properly drained.
 - If supporting structural members are not strong enough to take the unit's weight, the unit could fall out of place and cause serious injury.
 - Where the false ceiling is not noticeably on an incline.
 - Where there is no risk of combustible gas leakage.
 - Where sufficient clearance for maintenance and service can be ensured. **(Refer to Fig. 1)**
 - Where the total piping length involving indoor unit and outdoor unit is below the allowable piping length. (See the installation manual included with the outdoor unit for "6. REFRIGERANT PIPING.")
 - Locations where a maintenance hole can be installed. **(Refer to Fig. 2)**

⚠ CAUTION

- Install the indoor and outdoor units, power supply wires and transmission wires at least 3.3ft. away from televisions or radios in order to prevent image interference or noise. (Depending on the radio waves, a distance of 3.3ft. may not be sufficient enough to eliminate the noise.)

- (2) **Use suspension bolts for installation. Check whether the ceiling is strong enough to support the weight of the unit or not. If there is a risk, reinforce the ceiling before installing the unit.**

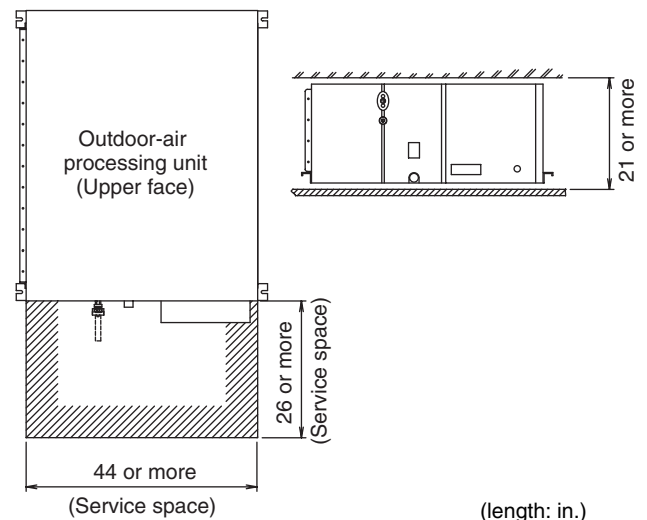

Fig. 1

4. PREPARATIONS BEFORE INSTALLATION

- (1) Relative positions of the unit and suspension bolt.
(Refer to Fig. 2)

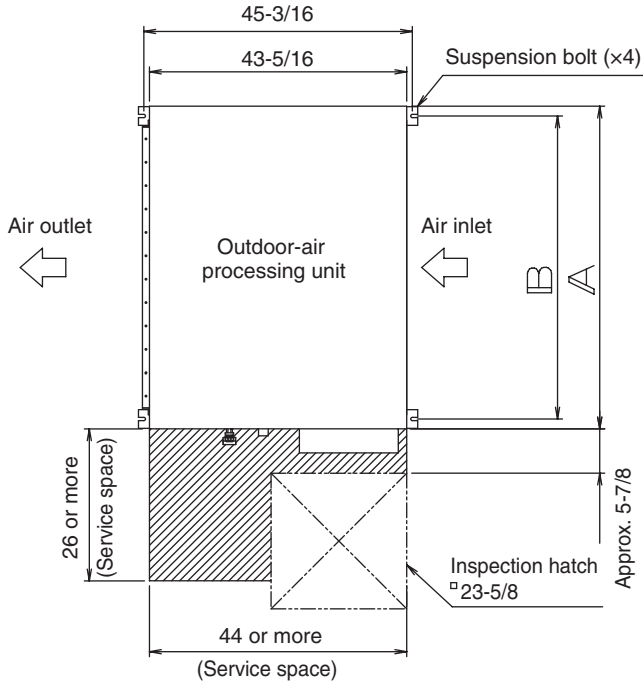
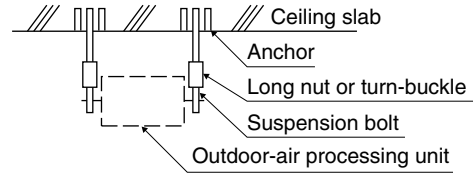

Fig. 2 (length: in.)

- (2) Install a canvas duct to the air outlet and air inlet so that vibration from the unit isn't transmitted to the duct or ceiling. You should also apply acoustic (insulation material) to the inside of the duct, and vibration insulation rubber to the suspension bolts.
- (3) Open the installation hole. (Pre-set ceilings)
- Once the installation hole is opened in the ceiling where the unit is to be installed, pass refrigerant and drain pipe and the power supply, transmission, and remote controller wire to the unit's pipe and wire connection ports. (See the chapter 6, 7, 9 for details.)
 - After opening the ceiling hole, it might be necessary to reinforce the ceiling frame to prevent shaking or to maintain the levelness of the ceiling. Consult an architect or carpenter for details.
- (4) Install suspension bolts.
(Use bolts of 3/8in. diameter.)
- Install the unit where supporting structures are strong enough to bear the unit's weight. Use embedded inserts or anchor bolts with new buildings and hole-in-anchors with old buildings. Adjust the distance to the ceiling beforehand.

< Installation example >



Note) All the above parts are field supplied.

Fig. 3

5. UNIT INSTALLATION

Installing optional accessories before installing the unit is easier. See the installation manuals included with the optional accessories.

As for the parts to be used for installation work, be sure to use the provided accessories and specified parts designated by our company.

- (1) Temporarily install the unit.

- Mount the hanger brackets to suspension bolts. Secure the hanger brackets on the top and the bottom with nuts <1>~<3> (M10, field supplied) and washers (M10, accessory 10).

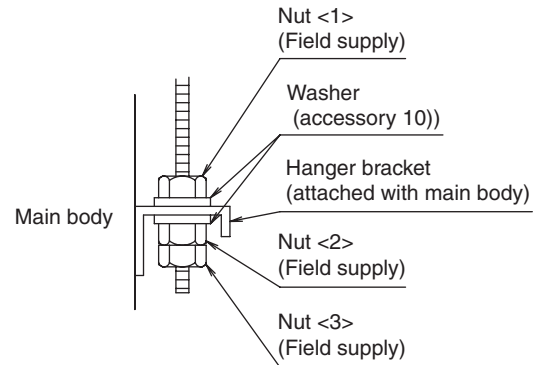

Fig. 4

- (2) Adjust the height of the unit with the nut <2>.
(Refer to Fig. 4)
- (3) Make sure the unit is level.
- Use a level or a vinyl tube filled with water to make sure that the unit is level and that the tilt (downward slope) to the drain socket and air inlet side is within 1°.
- (Refer to Fig. 5)

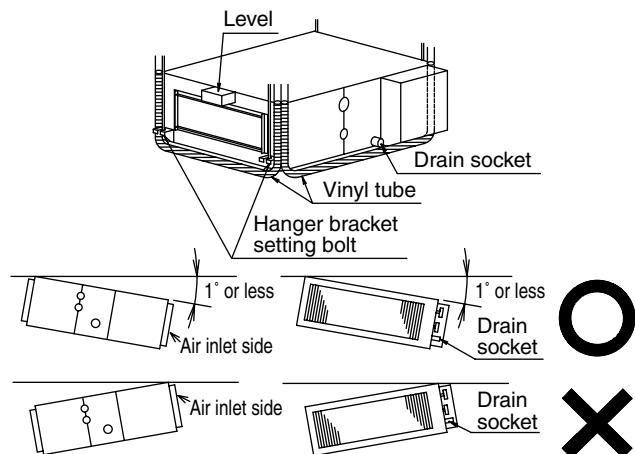

Fig. 5

(4) Tighten both upper and lower nuts <1>, <3>.

(Refer to Fig. 4)

(5) Insulate the four hanger brackets with the sealing pad. (accessory 6)) Insulate the hanger brackets so that the surface and edges of the hanger brackets cannot be seen.

(Refer to Fig. 6)

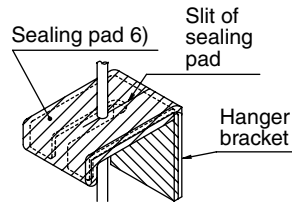

Fig. 6

CAUTION

Setting the unit at an angle opposite to the drain socket or air inlet side might cause leaks.

6. REFRIGERANT PIPING

(For refrigerant piping between outdoor unit and this unit, see the installation manual attached to the outdoor unit.

(Refer to Table 1)

(Execute heat insulation work completely on both sides of the gas pipe and the liquid pipe. Otherwise, a water leakage can result sometimes.)

(When using a heat pump, the temperature of the gas pipe can reach up to approximately 248°F, so use insulation which is sufficiently resistant.)

(Improve the insulation on the refrigerant piping depending on the installation environment. If the insulation is not sufficient, condensate may form on the surface of the insulation.)

(Before refrigerant piping work, check which type of refrigerant is used. Proper operation is not possible if the types of refrigerant are not the same.)

CAUTION

- Use a pipe cutter and flare suitable for the type of refrigerant.
- Apply ester oil or ether oil inside the flare portions before connecting. (Refer to Fig. 7)
- To prevent dust, moisture or other foreign matter from infiltrating the tube, either pinch the end or cover it with tape.
- Do not allow anything other than the designated refrigerant to get mixed into the refrigerant circuit, such as air, etc. If any refrigerant gas leaks while working on the unit, ventilate the room thoroughly right away.

- The outdoor unit is charged with refrigerant.
- Be sure to use both a spanner and torque wrench together, as shown in the drawing, when connecting or disconnecting pipes to/from the unit. (Refer to Fig. 8)
- Refer to Table 2 for the dimensions of flare nut spaces.
- When connecting the flare nut, coat the flare section inside with ester oil or ether oil, rotate three or four times first, then screw in. (Refer to Fig. 7)
- Refer to Table 2 for tightening torque.

Table 1

Unit to be connected	Gas pipe diameter	Liquid pipe diameter
FXMQ48MFVJU	φ5/8	φ3/8
FXMQ72MFVJU	φ3/4 Use attached pipe.	
FXMQ96MFVJU	φ7/8 Use attached pipe.	

Table 2

Pipe size	Tightening torque (ft.-lbf)	Flare dimensions A (in.)	Flare shape (in.)
φ 3/8"	24.1 – 29.4	0.504 – 0.520	
φ 5/8"	45.6 – 55.6	0.760 – 0.776	

NOTE

Use the flare nuts attached with the unit.

CAUTION

Over-tightening may damage the flare and cause a refrigerant leakage.

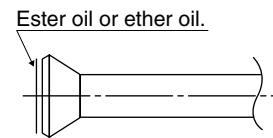

Fig. 7

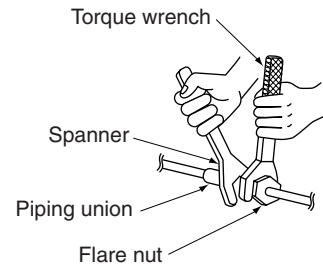

Fig. 8

Not recommendable but in case of emergency

You must use a torque wrench but if you are obliged to install the unit without a torque wrench, you may follow the installation method mentioned below.

After the work is finished, make sure to check that there is no gas leak.

When you keep on tightening the flare nut with a spanner, there is a point where the tightening torque suddenly increases. From that position, further tighten the flare nut the angle shown below:

Table 3

Pipe size	Further tightening angle	Recommended arm length of tool
φ 3/8"	60 to 90 degrees	Approx. 7-7/8in.
φ 5/8"	30 to 60 degrees	Approx. 11-13/16in.

- After checking the pipe-connection for gas leakage, be sure to insulate the liquid and gas pipe, referring to Fig.9, 10 and the following points.

FXMQ48MFVJU

1. Insulate the liquid and gas pipes using the insulation for fitting (accessory 3, 4)
(Tighten both edges with clamping material.)
2. Make sure the insulation for fitting (accessory 4) on the gas pipe has its seams facing up.
3. For the gas pipe, wrap the sealing pad (accessory 5) around the insulation for fitting (accessory 4) (flare nut part).

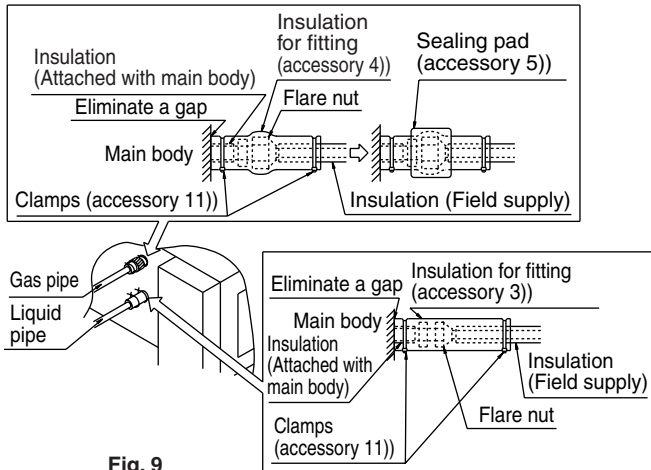

Fig. 9

FXMQ72 · 96MFVJU

1. Insulate the liquid pipe using the insulation for fitting (accessory 3)).
(Tighten both edges with clamping material.)
2. Use the attached pipe (accessory 1)) for connecting the gas pipes and make sure to insulate the gas pipes (using field supplied insulation) all the way to the base where they connect to the unit.
3. The turning torque of the hexagon head bolts (accessory 8)) to connect the attached pipe (accessory 1)) to the unit is 15.9 - 21.3ft/lbf.

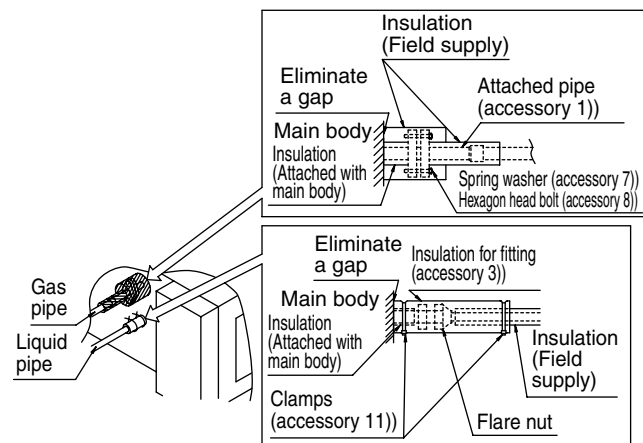

Fig. 10

CAUTION

Be sure to insulate any field pipe all the way to the pipe connection inside the unit. Any exposed pipe may cause condensate or burns if touched.

CAUTION

CAUTION TO BE TAKEN WHEN BRAZING REFRIGERANT PIPING

Do not use flux when brazing refrigerant piping. Therefore, use the phosphor copper brazing filler metal (BCuP-2/ B-Cu93P-710/795) which does not require flux.

(Flux has extremely harmful influence on refrigerant piping systems. For instance, if the chlorine based flux is used, it will cause pipe corrosion or, in particular, if the flux contains fluorine, it will damage the refrigerant oil.)

- Before brazing local refrigerant piping, nitrogen gas shall be blown through the piping to expel air from the piping. If your brazing is done without nitrogen gas blowing, a large amount of oxide film develops inside the piping, and could cause system malfunction.
- When brazing the refrigerant piping, only begin brazing after having carried out nitrogen substitution or while inserting nitrogen into the refrigerant piping. Once this is done, connect the unit with a flared or a flanged connection.
- Nitrogen should be set to 2.90PSI with a pressure-reducing valve if brazing while inserting nitrogen into the piping.

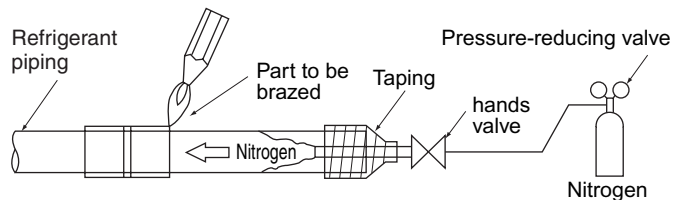

Fig. 11

7. DRAIN PIPING WORK

⟨⟨**Rig the drain pipe as shown below and take measures against condensate. Improperly rigged piping could lead to leaks and eventually wet furniture and belongings.**⟩⟩
⟨⟨**Insulate the drain pipes inside the building and the drain sockets.**⟩⟩

- (1) Carry out the drain piping.

- The drain pipe should be short with a downward slope lower than 1/100 and should prevent air pockets from forming.
- The diameter of the pipe is the same as that of the connecting pipe (PS1B), and should be kept equal to or greater than that of the connecting pipe.

NOTE

- If converging multiple drain pipes, install according to the procedure shown below. (Select an appropriate central drain pipe thickness for the units they will be connected to.)

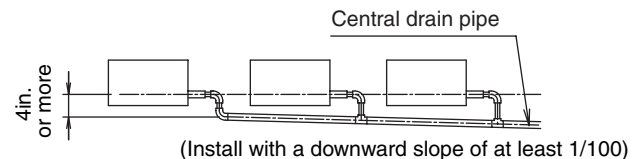

Fig. 12

- (2) After piping work is finished, check drainage flow smoothly.
- Open the water supply port, add approximately 61in³. of water slowly into the drain pan and check drainage flow. (Refer to Fig. 13)
- Pools of drainage can cause the drain pipes to clog.

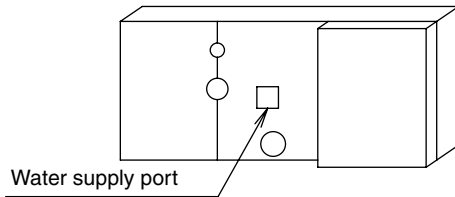

Fig. 13

CAUTION

- Do not connect the drain pipe directly to sewage pipes that smell of ammonia. The ammonia in the sewage might enter the unit through the drain pipes and corrode the heat exchanger.

8. INSTALLING THE DUCT

- Connect the duct (field supplied) as shown below. (Refer to Fig. 14)

<Air inlet side>

- Connect the duct to the inlet flange (field supplied).
- Wrap the inlet flange and the duct connection with aluminum tape or something similar to prevent air escaping.

<Air outlet side>

- Connect the duct to the outlet flange (attached with main body).
- Wrap the outlet flange and the duct connection with aluminum tape or something similar to prevent air escaping.
- Connect the outlet flange and the unit using the screws (accessory 9).

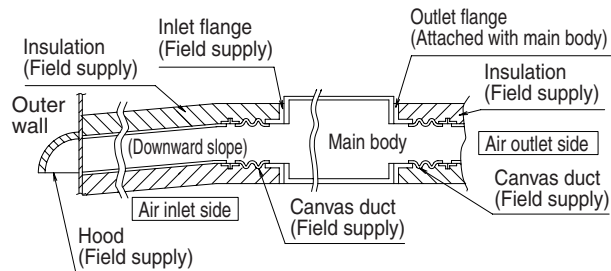

Fig. 14

NOTES

- Air filter is not standard accessory, but please mount it in the duct system of the air inlet side. Select its colorimetric method (gravity method) 50% or more.
- Make sure there is a downward slope on the air inlet side of the duct. This is to prevent rainwater from getting inside the unit.
- Connect the duct so that the unit draws in outside air in the inlet side. Otherwise, the unit may not work.
- Insulate the duct to prevent condensate from forming. (Material: glass wool or polyethylene foam, 1in. thick)
- Use electric insulation between the duct and the wall when using metal ducts to pass metal or wire laths or metal plating into wooden buildings.

9. ELECTRIC WIRING WORK

9-1 GENERAL INSTRUCTIONS

- All field supplied parts and materials and electric works must conform to local codes.
- Use copper wire only.
- For electric wiring work, refer to also "WIRING DIAGRAM" label attached to the electrical components box lid.
- For remote controller wiring details, refer to the installation manual attached to the remote controller.
- All wiring must be performed by an authorized electrician.
- This system consists of multiple indoor units. Mark each indoor unit as unit A, unit B..., and be sure the terminal board wiring to the outdoor unit is properly matched. If wiring and piping between the outdoor unit and the indoor unit are mismatched, the system may cause a malfunction.
- A ground fault circuit interrupter capable of shutting down power supply to the entire system must be installed.
- Refer to the installation manual attached to the outdoor unit for the size of power supply wire connected to the outdoor unit, the capacity of the ground fault circuit interrupter and switch, and wire instructions.
- Be sure to ground the unit.
- Do not connect the ground wire to gas and water pipes, lightning rods, or telephone ground wires.
 - Gas pipes : might cause explosions or fire if gas leaks.
 - Water pipes : no grounding effect if hard vinyl piping is used.
 - Telephone ground wires or lightning rods : might cause abnormally high electric potential in the ground during lightning.

9-2 ELECTRICAL CHARACTERISTICS

Model	Units			Power supply		Fan motor	
	Hz	Volts	Voltage range	MCA	MFA	W	FLA
FXMQ48MFVJU	60	208-230	Max. 253 Min. 187	2.1	15	380	1.7
FXMQ72MFVJU				3.6	15	380	2.9
FXMQ96MFVJU				4.1	15	380	3.3

MCA: Min. Circuit Amps (A); MFA: Max. Fuse Amps (A)
W: Fan Motor Rated Output (W); FLA: Full Load Amps (A)

9-3 SPECIFICATIONS FOR FIELD SUPPLIED FUSES AND WIRE

Model	Power supply wire		Remote controller wire Transmission wire	
	Field fuses 	Size	Wire	Size
FXMQ48MFVJU	15A	Size must comply with local codes.	Sheathed wire (2 wire)	AWG 18-16
FXMQ72MFVJU				
FXMQ96MFVJU				

NOTES

1. Select the particular size of electrical wire for power supply wire in accordance with the standards of the given nation and region.
2. Allowable length of transmission wire between indoor/outdoor units and between the indoor unit and the remote controller is as follows.
 - (1) Outdoor unit – Indoor unit:
Max. 3280ft. (Total wiring length: 6560ft.)

(2) Indoor unit – Remote controller:
Max. 1640ft.

(3) Max. branches No. of branches :16

3. Up to 16 branches are possible for unit-to unit cabling. No branch is allowed after first branch. (Refer to Fig. 15)

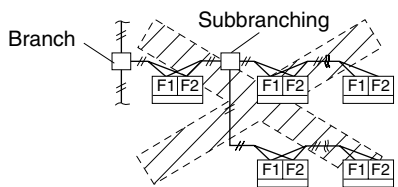

Fig. 15

10. WIRING EXAMPLE AND HOW TO SET THE REMOTE CONTROLLER

10-1 HOW TO CONNECT THE WIRES

(Remove the electrical components box lid and wire as shown in the figure 16, 17.)

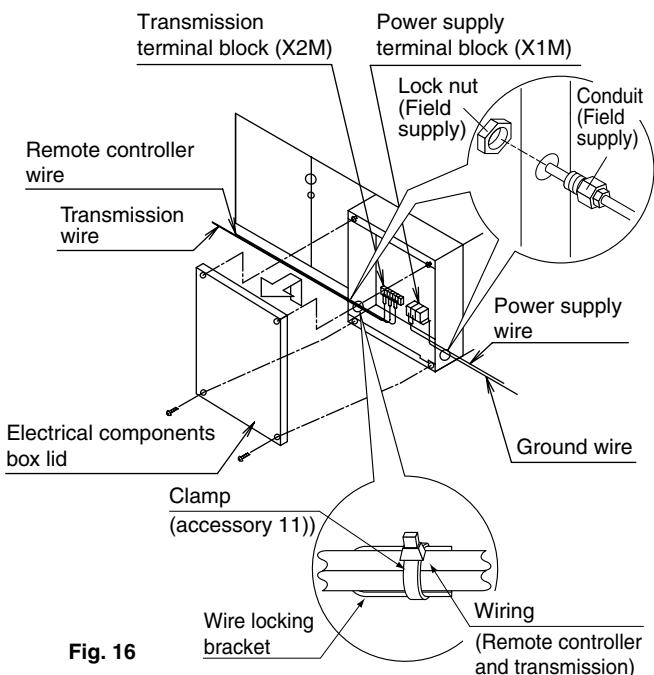
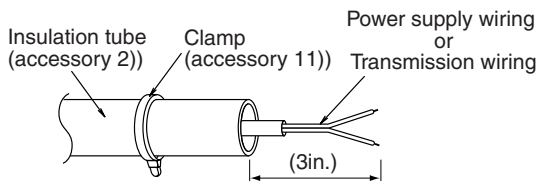

Fig. 16

• Routing power supply wiring and transmission wiring

Let the power supply wiring with a conduit pass through one of the holes on the side cover, and let the transmission wiring with a conduit pass through another hole.

- For protection from uninsulated live parts, thread the power supply wiring or the transmission wiring through the included insulation tube and secure it with the included clamp.



• Power supply wire, Ground wire (Refer to Fig. 17)

Connect the wire to L1 and L2 on the power supply terminal block (X1M). Also, connect the ground wire to the ground terminal. Take the power supply wire and the ground wire into the unit through the wiring through hole <1>, and firmly secure them together using the clamp (accessory 11).

• Transmission wire, Remote controller wire (Refer to Fig. 17)

Connect the transmission wire to F1 and F2 on the transmission terminal block (X2M). Connect the remote controller wire to P1 and P2 on the transmission terminal block (X2M). Take them into the unit through the wiring through hole <2>, and firmly secure the wires using the clamp (accessory 11).

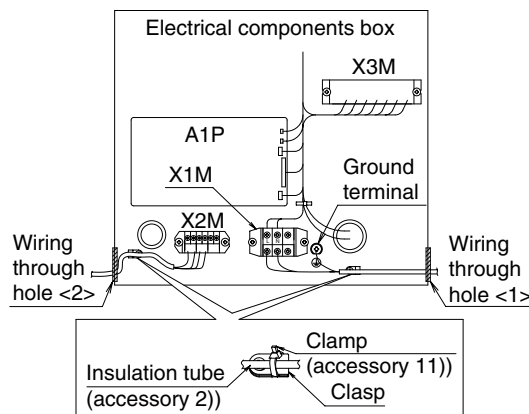

Fig. 17

⚠ CAUTION

- Wire the electrical components box so that the wiring is at least 3/8in. above the bottom of the electrical components box.
- Be sure to attach the sealing material or putty (field supplied) to the wiring through holes to prevent the infiltration of water as well as any insects and other small creatures from outside. Otherwise a short-circuit may occur inside the electrical components box.
- When clamping the wires, be sure no pressure is applied to the wire connections by using the included clamping material to make appropriate clamps. Also, when wiring, make sure the lid on the electrical components box fits snugly by arranging the wires neatly and attaching the electrical components box lid firmly. When attaching the electrical components box lid, make sure no wires get caught in the edges. Pass wire through the wiring through holes to prevent damage to them.
- Make sure the remote controller wire, the transmission wire and power supply wire, ground wire do not pass through the same locations outside of the unit, separating them by at least 2in., otherwise electrical noise (external static) could cause mistaken operation or breakage.

[PRECAUTIONS]

1. Use round crimp-style terminals for connecting wires to the power supply terminal block.
If unavailable, observe the following points when wiring.
 - Do not connect wires of different gauge to the same power supply terminal.
(Looseness in the connection may cause overheating.)

- Use the specified electric wire. Connect the wire securely to the terminal. Lock the wire down without applying excessive force to the terminal.

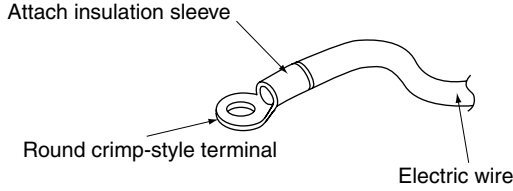

2. Tightening torque for the terminal screws.

- Use the correct screwdriver for tightening the terminal screws. If the blade of screwdriver is too small, the head of the screw might be damaged, and the screw will not be properly tightened.
- If the terminal screws are tightened too hard, screws might be damaged.
- Refer to the table below for the tightening torque of the terminal screws.

Terminal	Size	Tightening torque
Transmission terminal block (X2M)	M3.5	0.58 – 0.72 ft-lbf
Power supply terminal block (X1M)	M4	0.87 – 1.06 ft-lbf
Ground terminal	M5	2.23 – 3.01 ft-lbf

- Do not connect wires of different gauge to the same ground terminal. Looseness in the connection may deteriorate protection.
- Outside of the unit, keep transmission wire and remote controller wire at least 2in. away from power supply wire and ground wire. The unit may malfunction if subjected to electrical noise (external static).
- For remote controller wiring, refer to the “INSTALLATION MANUAL OF REMOTE CONTROLLER” attached to the remote controller.
- Never connect power supply wire to the transmission terminal block (X2M). A mistake of the sort could damage the entire system.**
- Use only specified wire and tightly connect wires to terminals. Be careful wires do not place external stress on terminals. Keep wiring in neat order and so as not to obstruct other equipment such as the electrical components box lid. Make sure the lid closes tight. Incomplete connections could result in overheating, and in worse case, electric shock or fire.

10-2 WIRING EXAMPLE

- Fit the power supply wiring of each unit with a switch and fuse as shown in the drawing.

COMPLETE SYSTEM EXAMPLE (3 SYSTEMS)

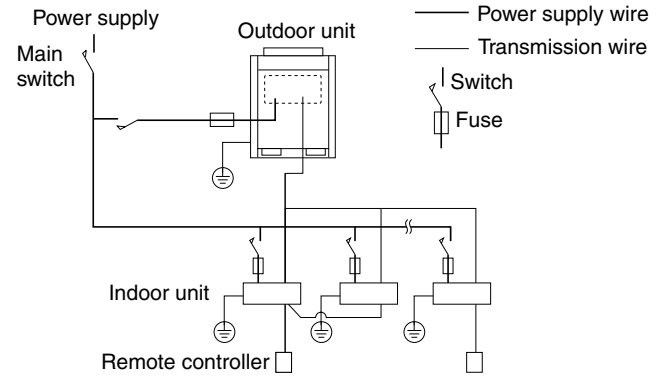

Fig. 18

1. When using 1 remote controller for 1 indoor unit. (Normal operation)

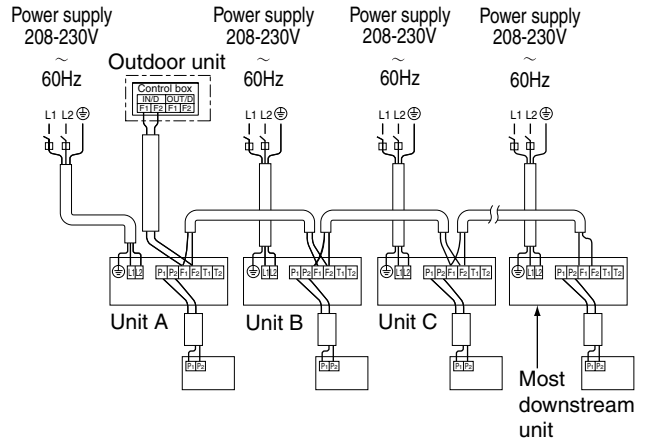

Fig. 19

2. For group control or control by 2 remote controllers

Note: It is not necessary to designate indoor unit address when using group control. The address is automatically set when power is activated.

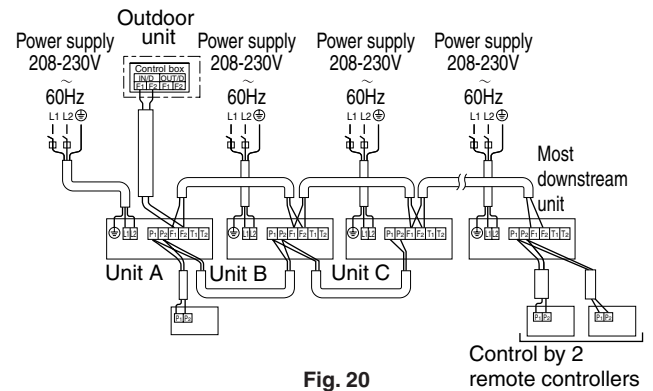

Fig. 20

[PRECAUTIONS]

- A single switch can be used to supply power to units on the same system. However, branch switches and branch ground fault circuit interrupters must be selected carefully.

10-3 CONTROL BY 2 REMOTE CONTROLLERS (Controlling 1 indoor unit by 2 remote controllers)

- When using 2 remote controllers, one must be set to "MAIN" and the other to "SUB".

MAIN/SUB CHANGEOVER

- Insert a \ominus screwdriver into the recess between the upper and lower part of remote controller and, working from the 2 positions, pry off the upper part.
(The remote controller PC board is attached to the upper part of remote controller.)

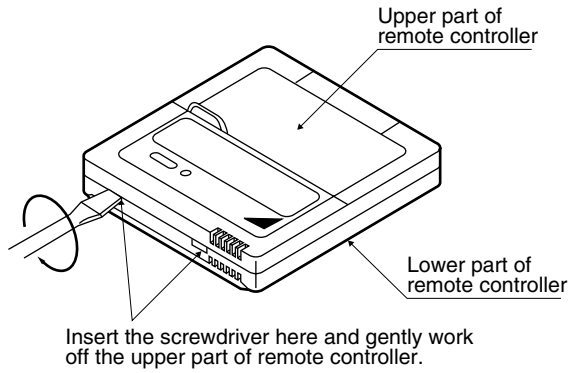

- Turn the MAIN/SUB changeover switch on one of the two remote controller PC boards to "S".
(Leave the switch of the other remote controller set to "M".)

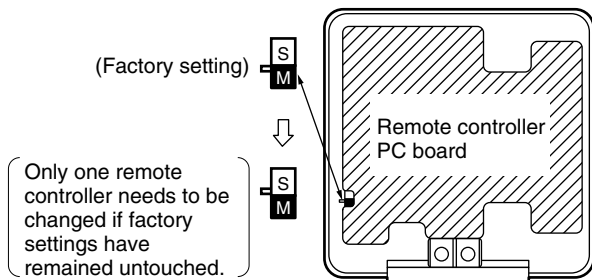

Wiring Method (See 10-1.)

- Remove the electrical components box lid.
- Add the second remote controller (slave) to the transmission terminal block (X2M/P1, P2) in the electrical components box. (There is no polarity.) (Refer to Fig. 20 and 9-3.)**

10-4 COMPUTERISED CONTROL (FORCED OFF AND ON/OFF OPERATION)

- Wire specifications and how to perform wiring
 - Connect the input from outside (Input A) to terminals T1 and T2 of the transmission terminal block (X2M).

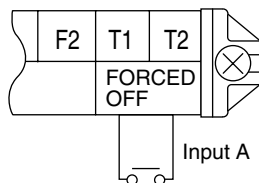

Wire specification	Sheathed vinyl cord or cable (2 wire)
Size	AWG18-16
Length	Max. 328ft.
External terminal	Contact that can ensure the minimum applicable load of 15 V DC, 1 mA.

- Actuation
 - The following table explains FORCED OFF and ON/OFF OPERATION in response to Input A.

FORCED OFF	ON/OFF OPERATION
Input A "ON" stops operation (impossible by remote controllers.)	Input A OFF → ON turns ON unit.
Input A OFF enables control by remote controller.	Input A ON → OFF turns OFF unit.

- How to select FORCED OFF and ON/OFF OPERATION
 - See "11. FIELD SETTING"

10-5 CENTRALIZED CONTROL

- For centralized control, it is necessary to designate the group No. For details, refer to the manual of each optional controllers for centralized control.

11. FIELD SETTING

11-1 How to set

- Make sure the electrical components box lids are closed on the indoor and outdoor units.**
- After the power is turned on, following the operation manual and designate the master remote controller using the remote controller.**
 - When setting the unit, ask the customer which remote controller he wants to designate as the master remote controller.
 - See also the operation manual included with the outdoor unit.
- Field setting must be made from the remote controller in accordance with the installation condition.**
 - Setting can be made by changing the "Mode No.", "FIRST CODE NO.", and "SECOND CODE NO."
 - Set the remote controller to the field set mode. For details, refer to the "HOW TO SET IN THE FIELD", in the remote controller manual. Lastly, make sure the customer keeps the "FIELD SETTING" manual, along with the operation manual, in a safe place.

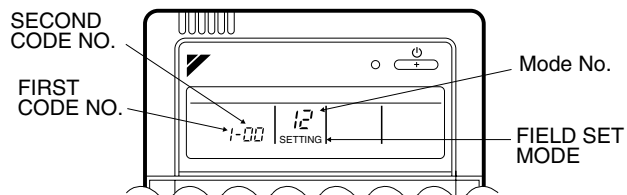

11-2 How to select FORCED OFF and ON/OFF OPERATION

- When in the field set mode, select mode No. 12, then set the first code (switch) No. to "1". Then set second code (position) No. to "01" for FORCED OFF and "02" for ON/OFF OPERATION. (FORCED OFF at factory set)

11-3 Setting air filter sign

- Remote controllers are equipped with liquid crystal display air filter signs to display the time to clean air filters.
- Change the SECOND CODE NO. according to Table 4 depending on the amount of dirt or dust in the room. (SECOND CODE NO. is factory set to "01" for filter contamination-light)

Table 4

Setting	Spacing time of display air filter sign (long life type)	Mode No.	FIRST CODE NO.	SECOND CODE NO.
Air filter contamination-light	Approx. 2500 hrs	10 (20)	0	01
Air filter contamination-heavy	Approx. 1250 hrs			02

11-4 Setting air discharge temperature

- Change the SECOND CODE NO. according to Table 5 depending on user's need. (SECOND CODE NO. is set to "06" for cooling "08" for heating at factory set)

Table 5

		for cooling	for heating
Mode No.		14 (24)	14 (24)
FIRST CODE NO.		3	4
SECOND CODE NO.	01	55°F	64°F
	02	57°F	66°F
	03	59°F	68°F
	04	61°F	70°F
	05	63°F	72°F
	06	64°F	73°F
	07	66°F	75°F
	08	68°F	77°F
	09	70°F	79°F
	10	72°F	81°F
	11	73°F	82°F
	12	75°F	84°F
	13	77°F	86°F

NOTE 

Air discharge temperature is not displayed on remote controller.

12. TEST OPERATION

Refer to the installation manual of the outdoor unit.

- The operation lamp of the remote controller will flash when a malfunction occurs. Check the malfunction code on the liquid crystal display to identify the point of trouble. An explanation of malfunction codes and the corresponding trouble is provided in installation manual of the outdoor unit.

If any of the items in Table 6 are displayed, there may be a problem with the wiring or power supply, so check the wiring again.

Table 6

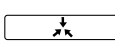
Remote control display	Content
"  " is lit up	<ul style="list-style-type: none"> • There is a short circuit at the FORCED OFF terminals (T1, T2)
"U3" is lit up	<ul style="list-style-type: none"> • Test operation is not completed.
"U4" is lit up "UH" is lit up	<ul style="list-style-type: none"> • The power on the outdoor unit is off. • The outdoor unit has not been wired for power supply. • Incorrect wiring for the transmission wire and / or FORCED OFF wire. • The transmission wire is cut.
No display	<ul style="list-style-type: none"> • The power on the indoor unit is off. • The indoor unit has not been wired for power supply. • Incorrect wiring for the remote controller wire, the transmission wire and / or the FORCED OFF wire. • The remote controller wire is cut.

DAIKIN AC (AMERICAS), INC.

1645 Wallace Drive, Suite 110
Carrollton, TX 75006

info@daikinac.com
www.daikinac.com

DAIKIN INDUSTRIES, LTD.

Head office:

Umeda Center Bldg., 2-4-12, Nakazaki-Nishi,
Kita-ku, Osaka, 530-8323 Japan

Tokyo office:

JR Shinagawa East Bldg., 2-18-1, Konan,
Minato-ku, Tokyo, 108-0075 Japan

