



Submittal Data Sheet

2 Ton, Ceiling-Mount, Uncased Air Handler

ACNF240016

STANDARD FEATURES

- Check flowrate for heat pump and cooling-only applications
- All-Aluminum tube/aluminum fin coil
- Direct-drive, resilient-mount, multi-speed motor
- Sequence-controlled and rust-resistant nickel chromium heating elements of 5, 6, 8 and 10 kW
- High-efficiency evaporator coil
- Quiet operation
- Models with EEM motors: ACNF25 & ACNF31
- Models with PSC motors: ACNF18, ACNF24, & ACNF30
- Available with and without heat
- AHRI Certified
- ETL Listed
- Primary/secondary drain connection in a high-temperature plastic drain pan
- Suitable for free-return installation (non-ducted return air)
- Galvanized-steel construction
- Factory-installed pull-type disconnect
- Easy service access





Submittal Data Sheet

2 Ton, Ceiling-Mount, Uncased Air Handler

ACNF240016

PERFORMANCE

Product Model No.	ACNF240016	Product Model Name:	2 Ton, Ceiling-Mount, Uncased Air Handler
Type:	Air Handler	Cooling Capacity (Nominal) (Btu/hr):	24,000
Blower Motor Rating (HP):	1/4		

PRODUCT DETAILS

Power Supply (V/Hz/Ph):	208-230 / 60 / 1	Airflow Rate (High / Low) (CFM):	880 / 840
Min. Circuit Amps MCA (A):	1.6	Suction Valve Connection Size (inch):	3/4
Max Overcurrent Protection (MOP) (A):	15	Liquid Valve Connection Size (inch):	3/8
Dimensions (HxWxD) (in):	10 x 43-1/2 x 21	Condensate Connection (inch):	3/4
Net Weight (lb):	69	Blower Size Diameter (inch):	6.31
Gross Weight (lb):	69	Blower Size Width (inch):	8.25



Submittal Data Sheet

2 Ton, Ceiling-Mount, Uncased Air Handler
ACNF240016

DIMENSIONAL DRAWING

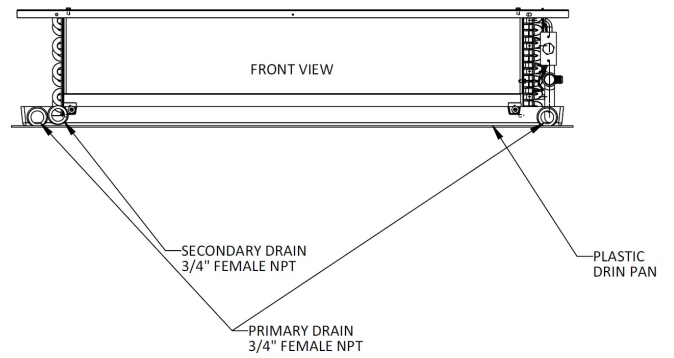
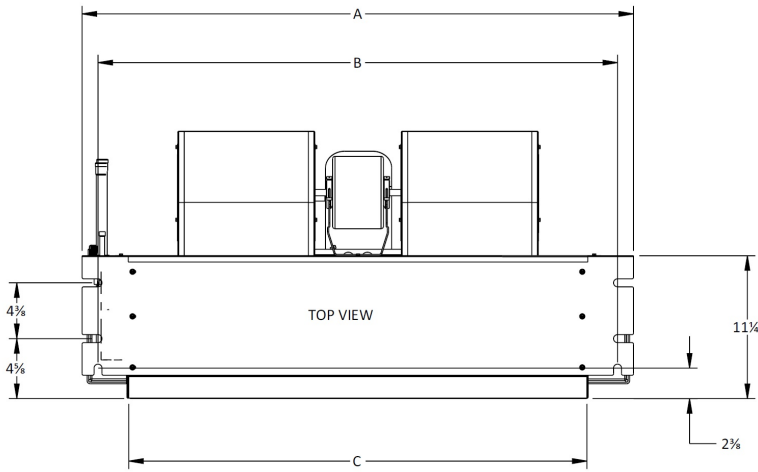
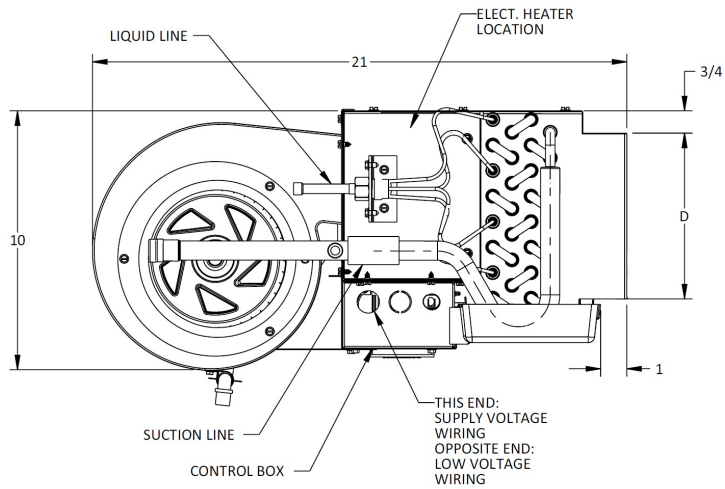

	ACNF18	ACNF24	ACNF25	ACNF30	ACNF31
A	37 ¹ / ₄ "	43 ¹ / ₄ "	43 ¹ / ₄ "	49 ¹ / ₄ "	49 ¹ / ₄ "
B	34 ³ / ₄ "	40 ³ / ₄ "	40 ³ / ₄ "	46 ³ / ₄ "	46 ³ / ₄ "
C	30"	36"	36"	42"	42"
D	6 ¹ / ₂ "	6 ¹ / ₂ "	6 ¹ / ₂ "	6 ¹ / ₂ "	6 ¹ / ₂ "