



## Submittal Data Sheet

2.5 Ton, Ceiling-Mount, Uncased Air Handler

ACNF301016

### STANDARD FEATURES

- Check flowrate for heat pump and cooling-only applications
- All-Aluminum tube/aluminum fin coil
- Direct-drive, resilient-mount, multi-speed motor
- Sequence-controlled and rust-resistant nickel chromium heating elements of 5, 6, 8 and 10 kW
- High-efficiency evaporator coil
- Quiet operation
- Models with EEM motors: ACNF25 & ACNF31
- Models with PSC motors: ACNF18, ACNF24, & ACNF30
- Available with and without heat
- AHRI Certified
- ETL Listed
- Primary/secondary drain connection in a high-temperature plastic drain pan
- Suitable for free-return installation (non-ducted return air)
- Galvanized-steel construction
- Factory-installed pull-type disconnect
- Easy service access





## Submittal Data Sheet

2.5 Ton, Ceiling-Mount, Uncased Air Handler

ACNF301016

### PERFORMANCE

Product Model No.	ACNF301016	Product Model Name:	2.5 Ton, Ceiling-Mount, Uncased Air Handler
Type:	Air Handler	Cooling Capacity (Nominal) (Btu/hr):	30,000
Blower Motor Rating (HP):	1/4		

### PRODUCT DETAILS

Power Supply (V/Hz/Ph):	208-230 / 60 / 1	Airflow Rate (High) (CFM):	
Min. Circuit Amps MCA (A):		Suction Valve Connection Size (inch):	3/4
Max Overcurrent Protection (MOP) (A):		Liquid Valve Connection Size (inch):	3/8
Dimensions (HxWxD) (in):	10 x 49-1/2 x 21	Condensate Connection (inch):	
Net Weight (lb):		Blower Size Diameter (inch):	6.75
Gross Weight (lb):	79	Blower Size Width (inch):	8.25



## Submittal Data Sheet

2.5 Ton, Ceiling-Mount, Uncased Air Handler

ACNF301016

## DIMENSIONAL DRAWING

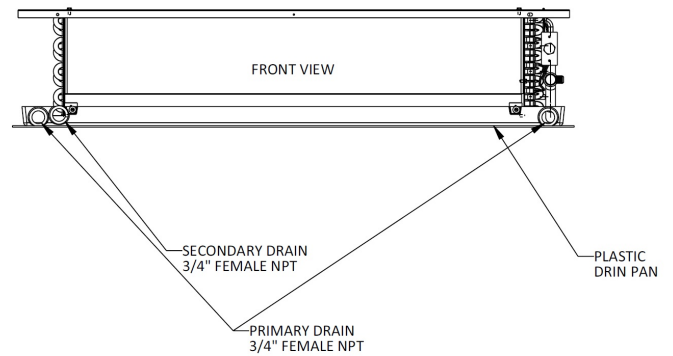
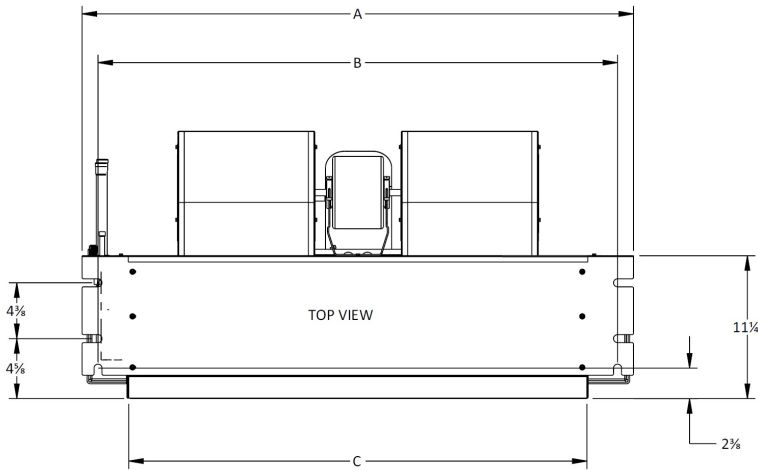
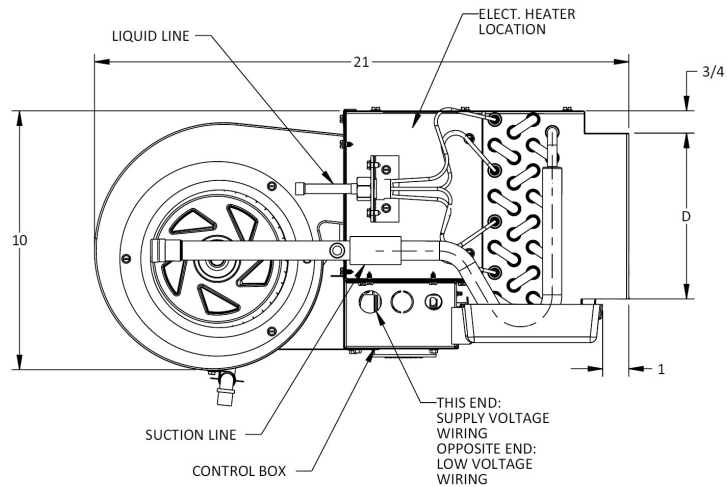

	ACNF18	ACNF24	ACNF25	ACNF30	ACNF31
A	37 <sup>1</sup> / <sub>4</sub> "	43 <sup>1</sup> / <sub>4</sub> "	43 <sup>1</sup> / <sub>4</sub> "	49 <sup>1</sup> / <sub>4</sub> "	49 <sup>1</sup> / <sub>4</sub> "
B	34 <sup>3</sup> / <sub>4</sub> "	40 <sup>3</sup> / <sub>4</sub> "	40 <sup>3</sup> / <sub>4</sub> "	46 <sup>3</sup> / <sub>4</sub> "	46 <sup>3</sup> / <sub>4</sub> "
C	30"	36"	36"	42"	42"
D	6 <sup>1</sup> / <sub>2</sub> "	6 <sup>1</sup> / <sub>2</sub> "	6 <sup>1</sup> / <sub>2</sub> "	6 <sup>1</sup> / <sub>2</sub> "	6 <sup>1</sup> / <sub>2</sub> "