



EDUS042211A

R-410A

Engineering Data

Split Type Air Conditioners

- Cooling Only / Heat Pump -

FTX-W Series

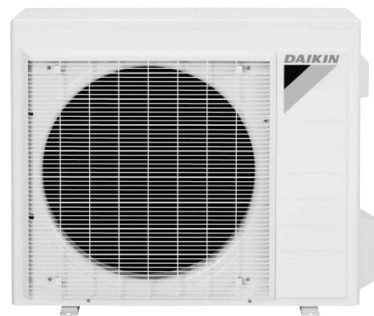

INVERTER

Split Type Air Conditioners

FTX-W Series

1. Lineup	3
2. Functions	4
3. Specifications.....	5
3.1 Cooling Only	5
3.2 Heat Pump.....	6
4. Dimensions	7
4.1 Indoor Unit	7
4.2 Outdoor Unit	8
5. Wiring Diagrams	9
5.1 Indoor Unit	9
5.2 Outdoor Unit	10
6. Piping Diagrams	11
6.1 Indoor Unit	11
6.2 Outdoor Unit	12
7. Capacity Tables	13
7.1 Cooling Only	13
7.2 Heat Pump.....	15
7.3 Capacity Correction Factor by the Length of Refrigerant Piping (Reference)	19
8. Operation Limit	20
9. Sound Level.....	21
9.1 Measuring Location	21
9.2 Indoor Unit	22
9.3 Outdoor Unit	23
10. Electric Characteristics	25
11. Installation Manual.....	26
11.1 Indoor Unit	26
11.2 Outdoor Unit	38
12. Operation Manual	52
12.1 FTX.....	52
12.2 General Safety Consideration.....	89
13. Options	94

13.1 Option List.....	94
13.2 <BRC944B2> Wired Remote Controller Installation Manual	95
13.3 <BRC944B2> Wired Remote Controller Operation Manual	97
13.4 <KRP413BB1S> Wiring Adaptor for Timer Clock / Remote Controller.....	109
13.5 <KRP928BB2S> Interface Adaptor for DIII-NET	113
13.6 <KRP980B2> Interface Adaptor for Residential Air Conditioner	116
13.7 <DCS302C71> Central Remote Controller Installation Manual.....	120
13.8 <DCS302C71> Central Remote Controller Operation Manual	125
13.9 <DCS301C71> Unified ON/OFF Controller Installation Manual	151
13.10 <DCS301C71> Unified ON/OFF Controller Operation Manual	156
13.11 <DST301BA61> Schedule Timer Controller.....	158
13.12 <DST301BA61> Schedule Timer Controller Installation Manual.....	159
13.13 <DST301BA61> Schedule Timer Controller Operation Manual	164
13.14 <KPW063B4> Air Direction Adjustment Grille	177
13.15 <KKG063A42> Back Protection Wire Net	179
13.16 <KEH067A41EA, KEH063A4E, FTDBHML> Drain Pan Heater	180
13.17 <KPS063A41> Snow Hood (Intake Side Plate).....	186
13.18 <KPS063A44> Snow Hood (Intake Rear Plate)	188
13.19 <KPS063A47> Snow Hood (Outlet)	190

1. Lineup

	Indoor Unit	Outdoor Unit	Power Supply
Cooling Only	FTX30WVJU9	RK30WMVJU9	1 phase, 208 - 230 V, 60 Hz
	FTX36WVJU9	RK36WMVJU9	
Heat Pump	FTX30WVJU9	RX30WMVJU9	
	FTX36WVJU9	RX36WMVJU9	

Note: Power Supply Intake ; Outdoor Unit

Cautions



1. Air conditioners should not be installed in areas where corrosive gasses, such as acid gas or alkaline gas, are produced.
2. If the outdoor unit is to be installed close to the sea shore, direct exposure to the sea breeze should be avoided and choose an outdoor unit with anti-corrosion treatment.

2. Functions

Category	Functions	FTX30/36WJU9	
		RK Series (C/O)	RX Series (H/P)
Basic Functions	Inverter (with inverter power control)	●	●
	Operation limit	Refer to page 20	
	PAM control	●	●
	Standby electricity saving	●	●
Compressor	Swing compressor	●	●
	Reluctance DC motor	●	●
Comfortable Airflow	Power-airflow dual flaps (horizontal blade)	●	●
	Wide-angle louvers (vertical blade)	●	●
	Auto-swing (up and down)	●	●
	Auto-swing (right and left)	●	●
	3-D airflow	●	●
	COMFORT AIRFLOW operation	●	●
Comfort Control	Auto fan speed	●	●
	Indoor unit quiet operation	●	●
	NIGHT QUIET mode (automatic)	—	—
	QUIET OUTDOOR UNIT operation (manual)	●	●
	INTELLIGENT EYE operation	●	●
	Quick warming function	—	●
	Hot-start function	—	●
	Automatic defrosting	—	●
Operation	Automatic cooling/heating changeover	—	●
	Program dry function	●	●
	Fan only	●	●
Lifestyle Convenience	POWERFUL operation (inverter)	●	●
	HOME LEAVE operation	—	—
	ECONO operation	●	●
	Indoor unit On/Off button	●	●
	Signal receiving sign	●	●
	R/C with back light	●	●
Health and Cleanliness	Titanium apatite deodorizing filter	●	●
	Air filter (pre-filter)	●	●
	Wipe-clean flat panel	●	●
	Washable grille	—	—
	MOLD PROOF operation	—	—
Remote Control and Timer	WEEKLY TIMER operation	●	●
	Count up-down ON/OFF timer	—	—
	24-hour ON/OFF TIMER	●	●
	NIGHT SET mode	●	●
Worry Free (Reliability & Durability)	Auto-restart (after power failure)	●	●
	Self-diagnosis (R/C, LED)	●	●
	Anti-corrosion treatment of outdoor heat exchanger	●	●
Flexibility	H/P, C/O compatible indoor unit	●	●
	Chargeless	32.8 ft (10 m)	32.8 ft (10 m)
	Either side drain (right or left)	●	●
	Low temperature cooling operation (–10°C) (14°F)	●★1	●★2
	°F/°C changeover R/C temperature display (factory setting: °F)	●	●
Remote Control	Remote control adaptor (normal open-pulse contact) (option)	●	●
	Remote control adaptor (normal open contact) (option)	●	●
	DIII-NET compatible (adaptor) (option)	●	●
	Wireless LAN connection	Option	Option
Remote Controller	Wireless	●	●
	Wired (option)	●	●

● : Available

★1 : Extend operation range to –30°C (–22°F) with an air direction adjustment grille (sold separately).

— : Not available

★2 : Extend operation range to –20°C (–4°F) with an air direction adjustment grille (sold separately).

3. Specifications

3.1 Cooling Only

Model	Indoor Unit		FTX30WVJU9		FTX36WVJU9	
	Outdoor Unit		RK30WMVJU9		RK36WMVJU9	
Power Supply			1 ϕ , 208 - 230 V, 60 Hz		1 ϕ , 208 - 230 V, 60 Hz	
Capacity	Rated	Btu/h	31,400 - 31,400		33,200 - 34,400	
	Min.	Btu/h	10,200 - 10,200		10,200 - 10,200	
	Max.	Btu/h	31,400 - 31,400		33,200 - 34,400	
Running Current (Rated)		A	15.70 - 14.20		17.00 - 17.00	
Power Consumption (Rated)		W	3,188 - 3,188		3,458 - 3,780	
Power Factor (Rated)		%	97.6 - 97.6		97.8 - 96.7	
SEER2 / HSPF2			17.50		15.90	
EER2 (Rated)		Btu/h-W	9.85		9.5 - 9.1	
Piping Connections	Liquid	in. (mm)	ϕ 1/4 (6.4)		ϕ 1/4 (6.4)	
	Gas	in. (mm)	ϕ 5/8 (15.9)		ϕ 5/8 (15.9)	
	Drain	in. (mm)	ϕ 5/8 (16)		ϕ 5/8 (16)	
Heat Insulation			Both Liquid and Gas Pipes		Both Liquid and Gas Pipes	
Max. Interunit Piping Length		ft (m)	98-1/2 (30)		98-1/2 (30)	
Max. Interunit Height Difference		ft (m)	65-5/8 (20)		65-5/8 (20)	
Chargeless		ft (m)	32-3/4 (10)		32-3/4 (10)	
Amount of Additional Charge of Refrigerant		oz/ft (g/m)	0.32 (30)		0.32 (30)	
Indoor Unit			FTX30WVJU9		FTX36WVJU9	
Front Panel Color			White (N9.5)		White (N9.5)	
Airflow Rate	H / M / L / SL	cfm	890 / 727 / 572 / 512		915 / 742 / 572 / 512	
		m ³ /min	25.2 / 20.6 / 16.2 / 14.5		25.9 / 21.0 / 16.2 / 14.5	
Fan	Type / Speed	Steps	Cross Flow Fan / 5 Steps, Quiet, Auto		Cross Flow Fan / 5 Steps, Quiet, Auto	
Air Direction Control			Right, Left, Horizontal, Downward		Right, Left, Horizontal, Downward	
Air Filter			Removable, Washable		Removable, Washable	
Running Current (Rated)		A	0.77 - 0.70		0.82 - 0.75	
Power Consumption (Rated)		W	90 - 90		95 - 95	
Power Factor (Rated)		%	56.2 - 55.9		55.7 - 55.1	
Temperature Control			Microcomputer Control		Microcomputer Control	
Dimensions (H x W x D)		in. (mm)	13-3/8 x 47-1/4 x 10-3/16 (340 x 1,200 x 259)		13-3/8 x 47-1/4 x 10-3/16 (340 x 1,200 x 259)	
Packaged Dimensions (H x W x D)		in. (mm)	13-7/16 x 51-9/16 x 16-7/8 (342 x 1,310 x 429)		13-7/16 x 51-9/16 x 16-7/8 (342 x 1,310 x 429)	
Weight (Mass)		lbs (kg)	38 (17)		38 (17)	
Gross Weight (Gross Mass)		lbs (kg)	49 (22)		49 (22)	
Sound Pressure Level		H / M / L / SL	53 / 47 / 40 / 37		54 / 47 / 40 / 37	
Outdoor Unit			RK30WMVJU9		RK36WMVJU9	
Casing Color			Ivory White		Ivory White	
Heat Exchanger		Fin Spec / Tube	Waffle Fin / ϕ 7 Hi-XSL Tube		Waffle Fin / ϕ 7 Hi-XSL Tube	
Fan Motor		Motor Output	HP		0.16	
Compressor		Type	Hermetically Sealed Swing Type		Hermetically Sealed Swing Type	
Refrigerant Oil		Model	2YC63AAXD		2YC63AAXD	
Refrigerant Oil		Type	FVC50K		FVC50K	
Refrigerant Oil		Charge	oz (L)		30.43 (0.900)	
Refrigerant		Type	R-410A		R-410A	
Refrigerant		Charge	lbs (kg)		3.64 (1.65)	
Airflow Rate		cfm (m ³ /min)	2,528 (71.6)		2,811 (79.6)	
Fan		Type	Propeller		Propeller	
Running Current (Rated)		A	14.93 - 13.50		16.18 - 16.25	
Power Consumption (Rated)		W	3,098 - 3,098		3,363 - 3,685	
Power Factor (Rated)		%	99.8 - 99.8		99.9 - 98.6	
Dimensions (H x W x D)		in. (mm)	28-15/16 x 34-1/4 x 12-5/8 (735 x 870 x 320)		28-15/16 x 34-1/4 x 12-5/8 (735 x 870 x 320)	
Packaged Dimensions (H x W x D)		in. (mm)	31-7/8 x 41-9/16 x 18-1/4 (810 x 1,056 x 464)		31-7/8 x 41-9/16 x 18-1/4 (810 x 1,056 x 464)	
Weight (Mass)		lbs (kg)	132 (60)		132 (60)	
Gross Weight (Gross Mass)		lbs (kg)	142 (65)		142 (65)	
Sound Pressure Level		dB(A)	56		59	
Conditions Based on		Indoor	80.0°FDB (26.7°CDB) / 67.0°FWB (19.4°CWB)		80.0°FDB (26.7°CDB) / 67.0°FWB (19.4°CWB)	
		Outdoor	95.0°FDB (35.0°CDB) / 75.0°FWB (24.0°CWB)		95.0°FDB (35.0°CDB) / 75.0°FWB (24.0°CWB)	
Piping Length			25 ft (7.5 m)		25 ft (7.5 m)	
Drawing No.			C: 3D143390A		C: 3D143390A	
Note(s)			SL: The quiet fan level of the airflow rate setting.			

Conversion Formulae	
kcal/h	= kW x 860
Btu/h	= kW x 3412
cfm	= m ³ /min x 35.3

3.2 Heat Pump

Model	Indoor Unit		FTX30WVJU9		FTX36WVJU9	
	Outdoor Unit		RX30WMVJU9		RX36WMVJU9	
			Cooling	Heating	Cooling	Heating
Power Supply			1 ϕ , 208 - 230 V, 60 Hz		1 ϕ , 208 - 230 V, 60 Hz	
Capacity	Rated	Btu/h	31,400 - 31,400	34,800 - 34,800	33,200 - 34,400	35,200 - 36,000
	Min.	Btu/h	10,200 - 10,200	10,200 - 10,200	10,200 - 10,200	10,200 - 10,200
	Max.	Btu/h	31,400 - 31,400	34,800 - 34,800	33,200 - 34,400	35,200 - 36,000
Running Current (Rated)	A		15.70 - 14.20	17.30 - 15.60	17.00 - 17.00	18.10 - 17.00
Power Consumption (Rated)	W		3,188 - 3,188	3,490 - 3,490	3,458 - 3,780	3,686 - 3,799
Power Factor (Rated)	%		97.6 - 97.6	97.0 - 97.3	97.8 - 96.7	97.9 - 97.2
SEER2 / HSPF2			17.50	7.50	15.90	7.50
EER2 (Rated)	Btu/h·W		9.85	—	9.5 - 9.1	—
COP2 (Rated)	W/W		—	2.90	—	2.74 - 2.72
Piping Connections	Liquid	in. (mm)	ϕ 1/4 (6.4)		ϕ 1/4 (6.4)	
	Gas	in. (mm)	ϕ 5/8 (15.9)		ϕ 5/8 (15.9)	
	Drain	in. (mm)	ϕ 5/8 (16)		ϕ 5/8 (16)	
Heat Insulation			Both Liquid and Gas Pipes		Both Liquid and Gas Pipes	
Max. Interunit Piping Length	ft (m)		98-1/2 (30)		98-1/2 (30)	
Max. Interunit Height Difference	ft (m)		65-5/8 (20)		65-5/8 (20)	
Chargeless	ft (m)		32-3/4 (10)		32-3/4 (10)	
Amount of Additional Charge of Refrigerant	oz/ft (g/m)		0.32 (30)		0.32 (30)	
Indoor Unit			FTX30WVJU9		FTX36WVJU9	
Front Panel Color			White (N9.5)		White (N9.5)	
Airflow Rate	H / M / L / SL	cfm	890 / 727 / 572 / 512	960 / 791 / 629 / 544	915 / 742 / 572 / 512	960 / 791 / 629 / 544
		m ³ /min	25.2 / 20.6 / 16.2 / 14.5	27.2 / 22.4 / 17.8 / 15.4	25.9 / 21.0 / 16.2 / 14.5	27.2 / 22.4 / 17.8 / 15.4
Fan	Type / Speed	Steps	Cross Flow Fan / 5 Steps, Quiet, Auto		Cross Flow Fan / 5 Steps, Quiet, Auto	
Air Direction Control			Right, Left, Horizontal, Downward		Right, Left, Horizontal, Downward	
Air Filter			Removable, Washable		Removable, Washable	
Running Current (Rated)	A		0.77 - 0.70	0.82 - 0.75	0.82 - 0.75	0.82 - 0.75
Power Consumption (Rated)	W		90 - 90	95 - 95	95 - 95	95 - 95
Power Factor (Rated)	%		56.2 - 55.9	55.7 - 55.1	55.7 - 55.1	55.7 - 55.1
Temperature Control			Microcomputer Control		Microcomputer Control	
Dimensions (H × W × D)	in. (mm)		13-3/8 × 47-1/4 × 10-3/16 (340 × 1,200 × 259)		13-3/8 × 47-1/4 × 10-3/16 (340 × 1,200 × 259)	
Packaged Dimensions (H × W × D)	in. (mm)		13-7/16 × 51-9/16 × 16-7/8 (342 × 1,310 × 429)		13-7/16 × 51-9/16 × 16-7/8 (342 × 1,310 × 429)	
Weight (Mass)	lbs (kg)		38 (17)		38 (17)	
Gross Weight (Gross Mass)	lbs (kg)		49 (22)		49 (22)	
Sound Pressure Level	H / M / L / SL	dB(A)	53 / 47 / 40 / 37	53 / 46 / 38 / 35	54 / 47 / 40 / 37	53 / 46 / 38 / 35
Outdoor Unit			RX30WMVJU9		RX36WMVJU9	
Casing Color			Ivory White		Ivory White	
Heat Exchanger	Fin Spec / Tube		Waffle Fin / ϕ 7 Hi-XSL Tube		Waffle Fin / ϕ 7 Hi-XSL Tube	
Fan Motor	Motor Output	HP	0.16		0.16	
Compressor	Type		Hermetically Sealed Swing Type		Hermetically Sealed Swing Type	
	Model		2YC63AAXD		2YC63AAXD	
Refrigerant Oil	Type		FVC50K		FVC50K	
	Charge	oz (L)	30.43 (0.900)		30.43 (0.900)	
Refrigerant	Type		R-410A		R-410A	
	Charge	lbs (kg)	3.64 (1.65)		3.64 (1.65)	
Airflow Rate	cfm (m ³ /min)		2,528 (71.6)	2,274 (64.4)	2,811 (79.6)	2,352 (66.6)
Fan	Type		Propeller		Propeller	
Running Current (Rated)	A		14.93 - 13.50	16.48 - 14.85	16.18 - 16.25	17.28 - 16.25
Power Consumption (Rated)	W		3,098 - 3,098	3,395 - 3,395	3,363 - 3,685	3,591 - 3,704
Power Factor (Rated)	%		99.8 - 99.8	99.0 - 99.4	99.9 - 98.6	99.9 - 99.1
Dimensions (H × W × D)	in. (mm)		28-15/16 × 34-1/4 × 12-5/8 (735 × 870 × 320)		28-15/16 × 34-1/4 × 12-5/8 (735 × 870 × 320)	
Packaged Dimensions (H × W × D)	in. (mm)		31-7/8 × 41-9/16 × 18-1/4 (810 × 1,056 × 464)		31-7/8 × 41-9/16 × 18-1/4 (810 × 1,056 × 464)	
Weight (Mass)	lbs (kg)		133 (60)		133 (60)	
Gross Weight (Gross Mass)	lbs (kg)		143 (65)		143 (65)	
Sound Pressure Level	dB(A)		56	58	59	59
Conditions Based on	Indoor		80.0°FDB (26.7°CDB) / 67.0°FWB (19.4°CWB)	70.0°FDB (21.1°CDB) / 60.0°FWB (15.6°CWB)	80.0°FDB (26.7°CDB) / 67.0°FWB (19.4°CWB)	70.0°FDB (21.1°CDB) / 60.0°FWB (15.6°CWB)
	Outdoor		95.0°FDB (35.0°CDB) / 75.0°FWB (24.0°CWB)	47.0°FDB (8.3°CDB) / 43.0°FWB (6.1°CWB)	95.0°FDB (35.0°CDB) / 75.0°FWB (24.0°CWB)	47.0°FDB (8.3°CDB) / 43.0°FWB (6.1°CWB)
	Piping Length		25 ft (7.5 m)		25 ft (7.5 m)	
Drawing No.			C: 3D143389A		C: 3D143389A	
Note(s)			SL: The quiet fan level of the airflow rate setting.			

Conversion Formulae
kcal/h = kW × 860
Btu/h = kW × 3412
cfm = m ³ /min × 35.3

4. Dimensions

4.1 Indoor Unit FTX30/36WVJU9

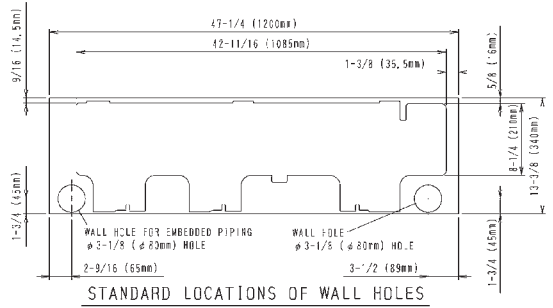
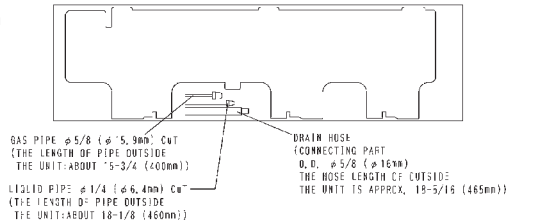
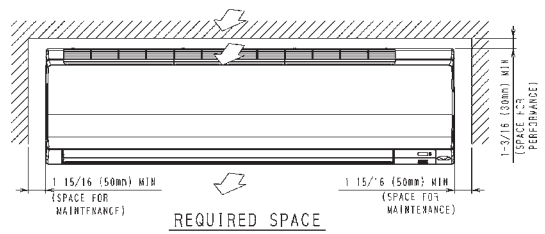
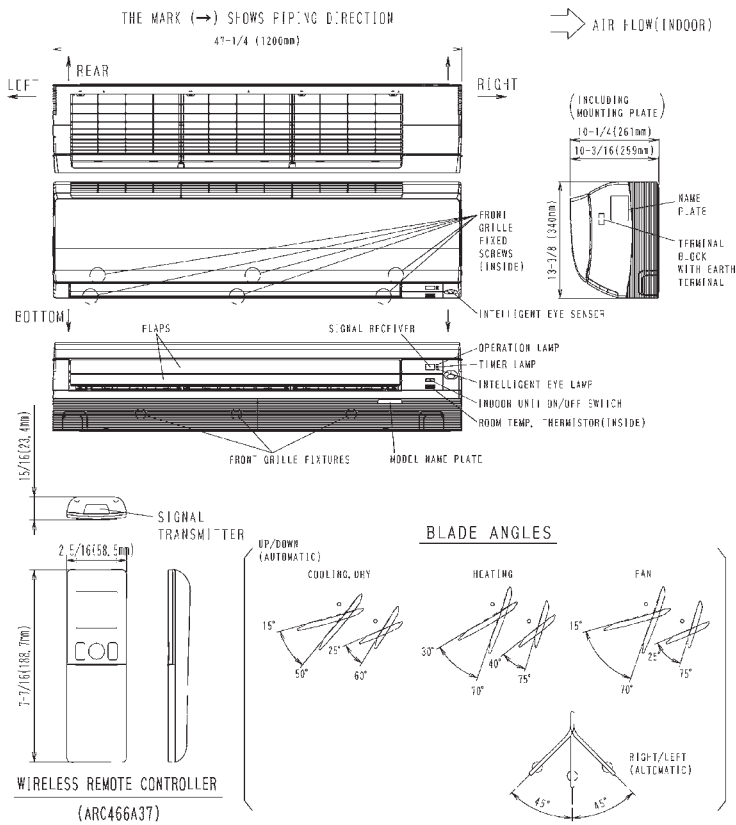

3D107868

4.2 Outdoor Unit RK30/36WMVJU9, RX30/36WMVJU9

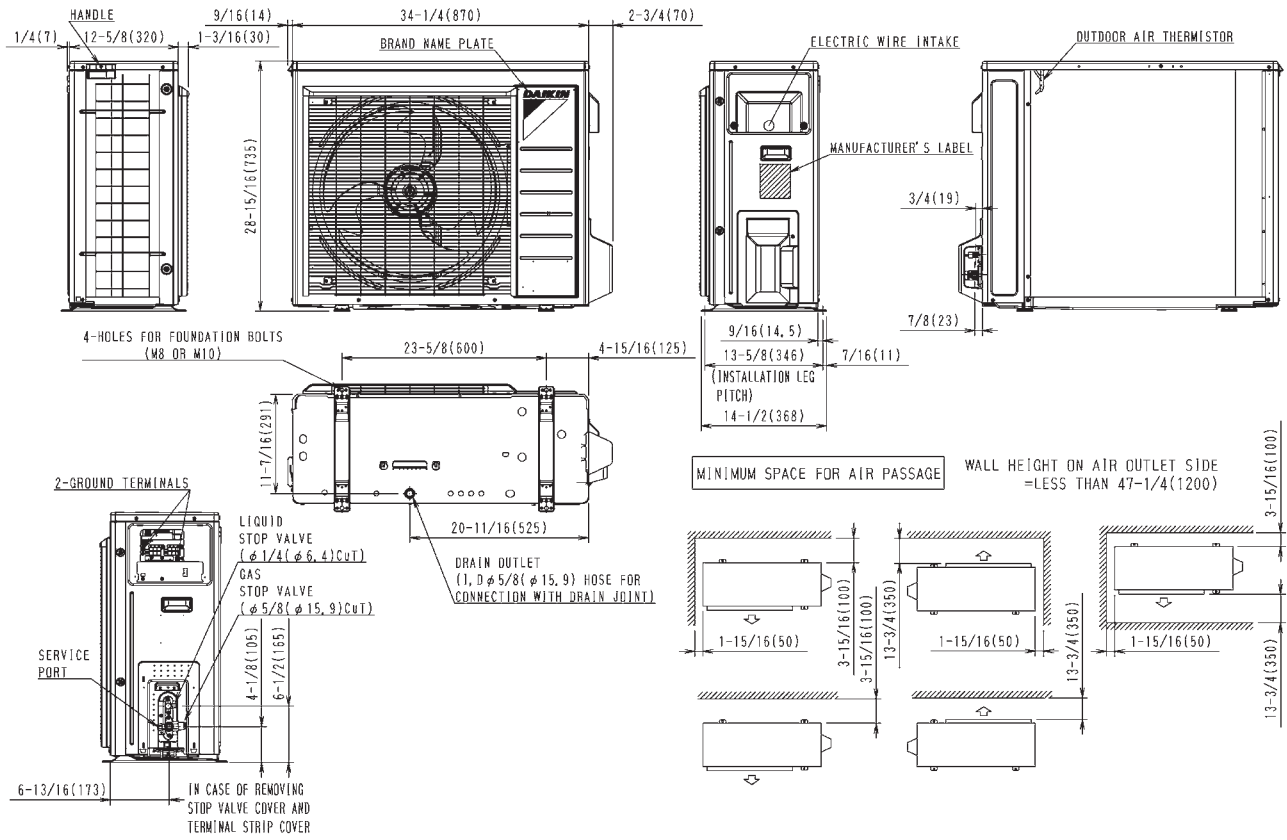

3D107983A

5. Wiring Diagrams

5.1 Indoor Unit FTX30/36WVJU9

WIRING DIAGRAM

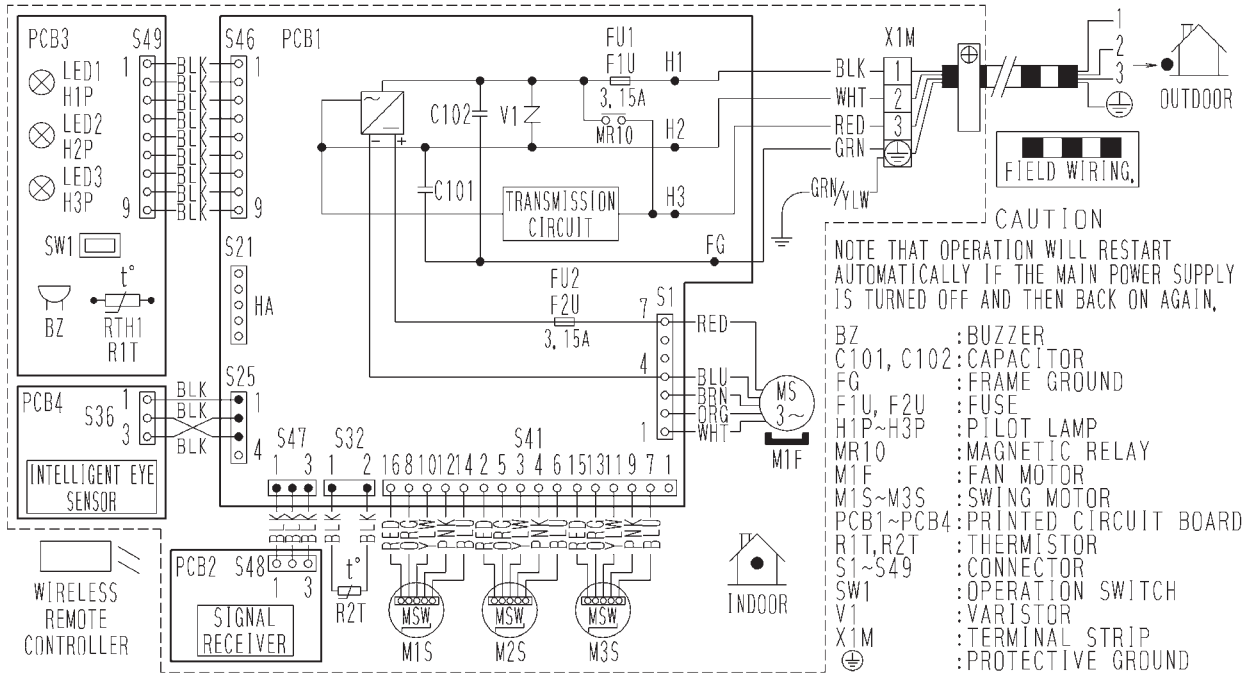

C: 3D060942X

5.2 Outdoor Unit RK30/36WMVJU9, RX30/36WMVJU9

WIRING DIAGRAM

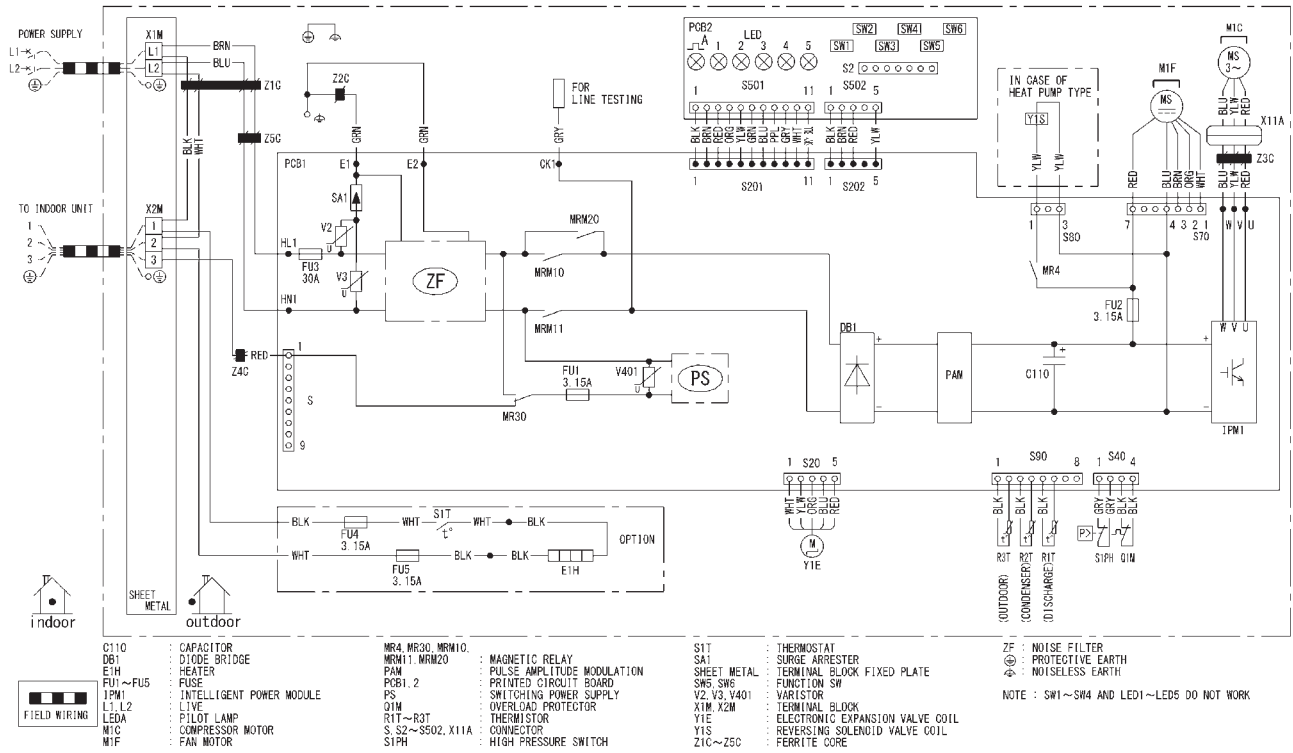

3D141458

6. Piping Diagrams

6.1 Indoor Unit

FTX30/36WVJU9

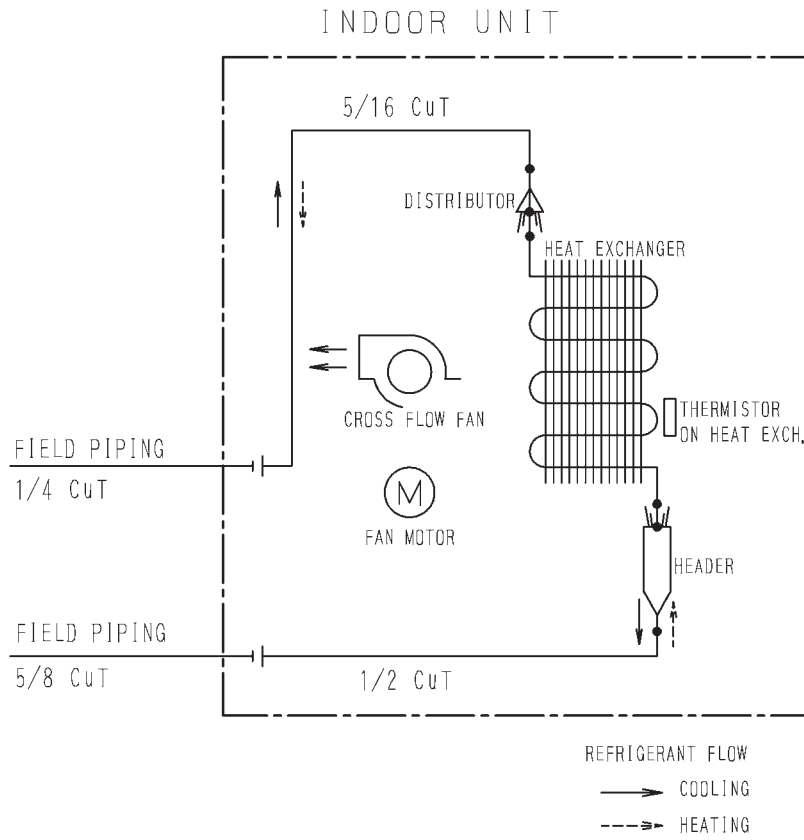

4D107870

6.2 Outdoor Unit RK30/36WMVJU9

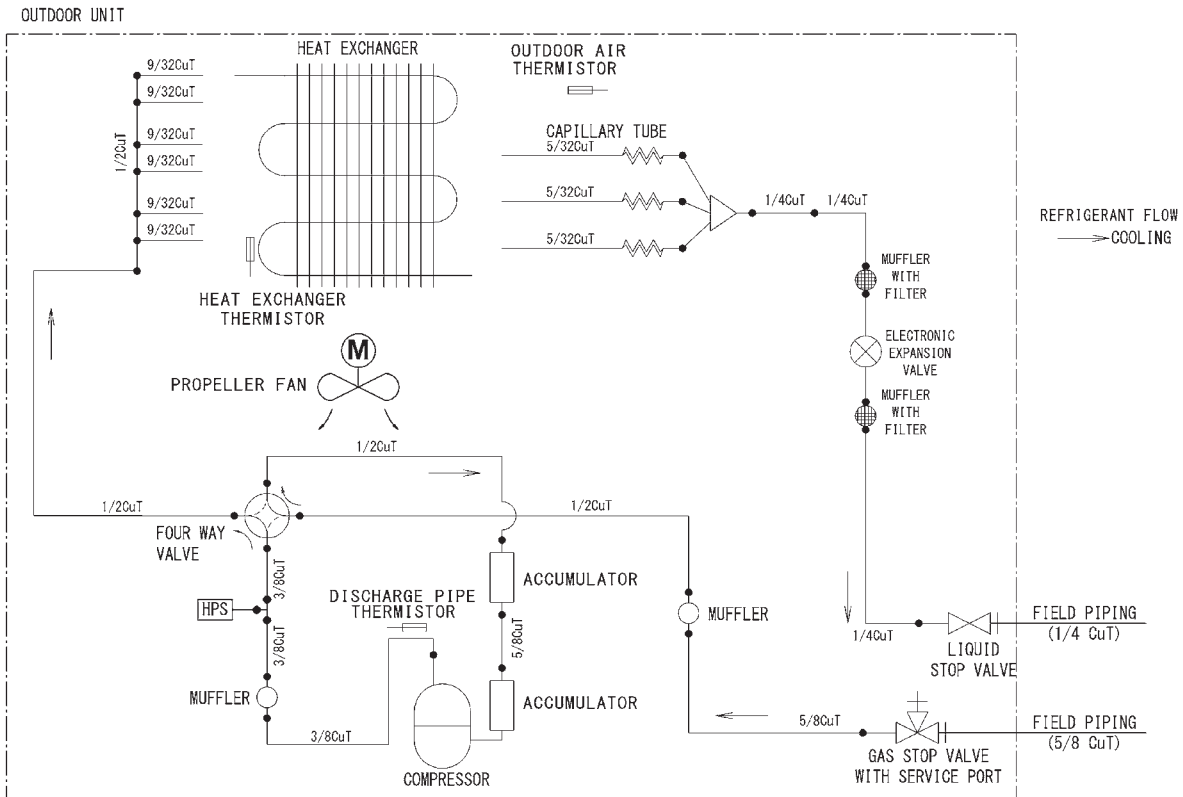

unit: inch

3D141504

RX30/36WMVJU9

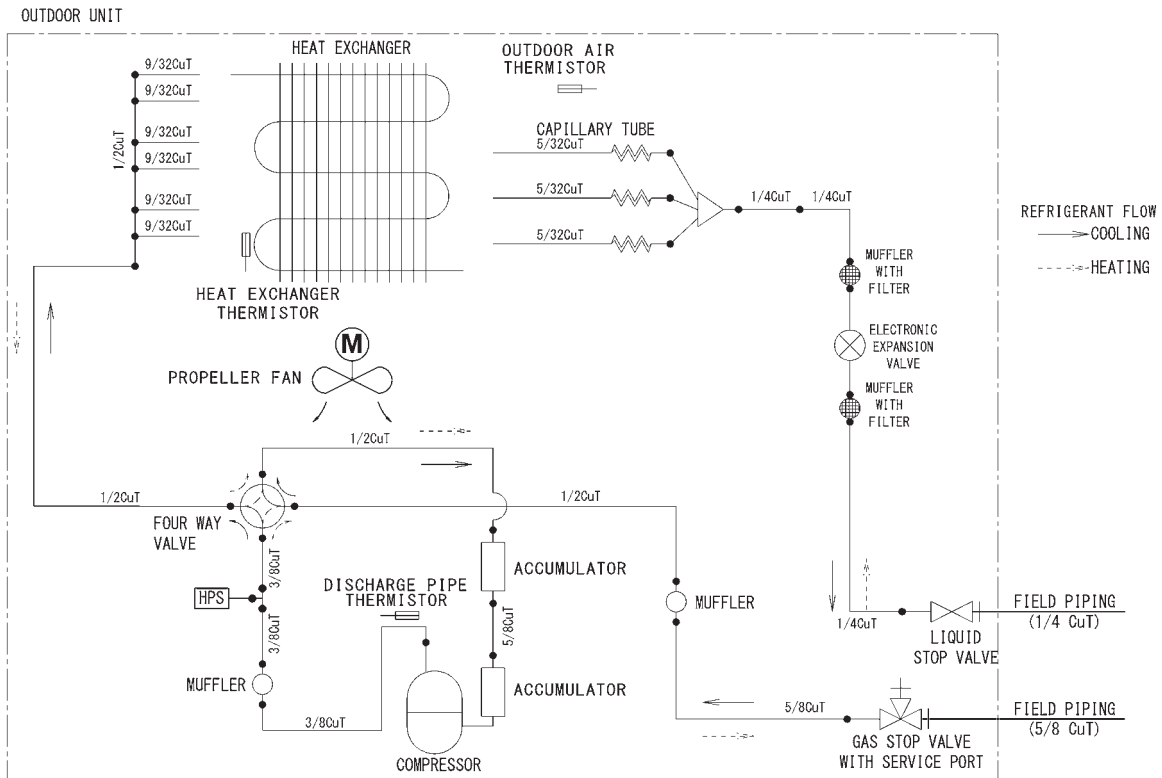

unit: inch

3D141503

7. Capacity Tables

7.1 Cooling Only

FTX30WVJU9 + RK30WMVJU9

Cooling (60 Hz, 208 V)

AFR	25.22
BF	0.34

Temp: Celsius / TC, SHC, PI: kW

INDOOR		OUTDOOR TEMPERATURE (°CDB)																	
EWB °C	EDB °C	10			20			30			35			40			46		
		TC	SHC	PI	TC	SHC	PI	TC	SHC	PI	TC	SHC	PI	TC	SHC	PI	TC	SHC	PI
14.0	20.0	8.10	5.71	1.83	8.10	5.71	2.39	8.10	5.71	2.92	8.10	5.71	3.15	7.39	5.33	3.13	5.92	4.59	2.64
16.0	22.0	9.95	6.38	1.95	9.83	6.31	2.46	8.97	5.86	2.93	8.55	5.64	3.17	7.79	5.27	3.13	6.33	4.58	2.64
18.0	25.0	11.11	6.94	2.00	10.25	6.51	2.47	9.40	6.09	2.95	8.97	5.88	3.18	8.20	5.53	3.13	6.74	4.88	2.64
19.4	26.7	11.32	7.18	2.01	10.46	6.77	2.48	9.61	6.36	2.95	9.18	6.16	3.19	8.40	5.81	3.13	6.94	5.19	2.64
22.0	30.0	11.95	6.86	2.03	11.10	6.49	2.50	10.24	6.13	2.97	9.81	5.96	3.21	9.01	5.63	3.13	7.55	5.08	2.64
24.0	32.0	12.37	6.63	2.04	11.52	6.29	2.52	10.66	5.96	2.99	10.24	5.80	3.22	9.41	5.50	3.13	7.95	4.99	2.64

Temp: Fahrenheit / TC, SHC: kBtu/h / PI: kW

INDOOR		OUTDOOR TEMPERATURE (°FDB)																	
EWB °F	EDB °F	50			68			86			95			104			115		
		TC	SHC	PI	TC	SHC	PI	TC	SHC	PI	TC	SHC	PI	TC	SHC	PI	TC	SHC	PI
57.2	68.0	27.65	19.47	1.83	27.65	19.47	2.39	27.65	19.47	2.92	27.65	19.47	3.15	25.20	18.18	3.13	20.21	15.67	2.64
60.8	71.6	33.96	21.76	1.95	33.53	21.53	2.46	30.62	20.00	2.93	29.16	19.26	3.17	26.58	17.98	3.13	21.60	15.62	2.64
64.4	77.0	37.89	23.68	2.00	34.98	22.20	2.47	32.06	20.77	2.95	30.60	20.08	3.18	27.97	18.85	3.13	22.98	16.64	2.64
67.0	80.0	38.61	24.51	2.01	35.70	23.08	2.48	32.78	21.70	2.95	31.40	21.03	3.19	28.66	19.84	3.13	23.68	17.70	2.64
71.6	86.0	40.78	23.42	2.03	37.86	22.15	2.50	34.95	20.92	2.97	33.49	20.32	3.21	30.74	19.23	3.13	25.75	17.33	2.64
75.2	89.6	42.22	22.62	2.04	39.31	21.46	2.52	36.39	20.33	2.99	34.93	19.79	3.22	32.12	18.76	3.13	27.14	17.02	2.64

Cooling (60 Hz, 230 V)

AFR	25.22
BF	0.34

Temp: Celsius / TC, SHC, PI: kW

INDOOR		OUTDOOR TEMPERATURE (°CDB)																	
EWB °C	EDB °C	10			20			30			35			40			46		
		TC	SHC	PI	TC	SHC	PI	TC	SHC	PI	TC	SHC	PI	TC	SHC	PI	TC	SHC	PI
14.0	20.0	8.10	5.71	1.83	8.10	5.71	2.39	8.10	5.71	2.92	8.10	5.71	3.15	7.70	5.49	3.39	6.26	4.76	2.92
16.0	22.0	9.95	6.38	1.95	9.83	6.31	2.46	8.97	5.86	2.93	8.55	5.64	3.17	8.12	5.43	3.40	6.67	4.74	2.92
18.0	25.0	11.11	6.94	2.00	10.25	6.51	2.47	9.40	6.09	2.95	8.97	5.88	3.18	8.54	5.68	3.42	7.08	5.02	2.92
19.4	26.7	11.32	7.18	2.01	10.46	6.77	2.48	9.61	6.36	2.95	9.18	6.16	3.19	8.75	5.97	3.42	7.28	5.33	2.92
22.0	30.0	11.95	6.86	2.03	11.10	6.49	2.50	10.24	6.13	2.97	9.81	5.96	3.21	9.39	5.78	3.44	7.89	5.21	2.92
24.0	32.0	12.37	6.63	2.04	11.52	6.29	2.52	10.66	5.96	2.99	10.24	5.80	3.22	9.81	5.64	3.46	8.29	5.11	2.92

Temp: Fahrenheit / TC, SHC: kBtu/h / PI: kW

INDOOR		OUTDOOR TEMPERATURE (°FDB)																	
EWB °F	EDB °F	50			68			86			95			104			115		
		TC	SHC	PI	TC	SHC	PI	TC	SHC	PI	TC	SHC	PI	TC	SHC	PI	TC	SHC	PI
57.2	68.0	27.65	19.47	1.83	27.65	19.47	2.39	27.65	19.47	2.92	27.65	19.47	3.15	26.26	18.73	3.39	21.38	16.24	2.92
60.8	71.6	33.96	21.76	1.95	33.53	21.53	2.46	30.62	20.00	2.93	29.16	19.26	3.17	27.70	18.53	3.40	22.76	16.16	2.92
64.4	77.0	37.89	23.68	2.00	34.98	22.20	2.47	32.06	20.77	2.95	30.60	20.08	3.18	29.14	19.39	3.42	24.14	17.14	2.92
67.0	80.0	38.61	24.51	2.01	35.70	23.08	2.48	32.78	21.70	2.95	31.40	21.03	3.19	29.86	20.37	3.42	24.84	18.19	2.92
71.6	86.0	40.78	23.42	2.03	37.86	22.15	2.50	34.95	20.92	2.97	33.49	20.32	3.21	32.03	19.74	3.44	26.91	17.76	2.92
75.2	89.6	42.22	22.62	2.04	39.31	21.46	2.52	36.39	20.33	2.99	34.93	19.79	3.22	33.47	19.25	3.46	28.30	17.42	2.92

Symbols:

AFR	: Airflow rate	(m ³ /min.)
BF	: Bypass factor	
EWB	: Entering wet bulb temp.	(°C) / (°F)
EDB	: Entering dry bulb temp.	(°C) / (°F)
TC	: Total capacity	(kW) / (kBtu/h)
SHC	: Sensible heat capacity	(kW) / (kBtu/h)
PI	: Power input	(kW)

Notes:

- shows nominal (rated) capacities and power input.
- TC, PI and SHC must be calculated by interpolation using the figures in the above tables. (Figures out of the tables should not be used for calculation.)
- Capacities are based on the following conditions.
Corresponding refrigerant piping length : 25 ft (7.5 m)
Level difference : 0 ft (0 m)
- Airflow rate (AFR) and Bypass factor (BF) are tabulated above table.

FTX36WVJU9 + RK36WMVJU9

Cooling (60 Hz, 208 V)

AFR	25.92
BF	0.34

Temp: Celsius / TC, SHC, PI: kW

INDOOR			OUTDOOR TEMPERATURE (°CDB)																	
EWB	EDB	10			20			30			35			40			46			
		°C	°C	TC	SHC	PI	TC	SHC	PI	TC	SHC	PI	TC	SHC	PI	TC	SHC	PI	TC	SHC
14.0	20.0	8.33	5.87	2.02	8.33	5.87	2.65	8.33	5.87	3.20	8.33	5.87	3.46	7.50	5.43	3.14	5.97	4.66	2.64	
16.0	22.0	10.23	6.55	2.13	10.23	6.55	2.69	9.56	6.20	3.21	9.10	5.96	3.47	7.93	5.38	3.14	6.40	4.66	2.64	
18.0	25.0	11.83	7.35	2.20	10.92	6.88	2.71	10.01	6.43	3.23	9.55	6.21	3.49	8.36	5.65	3.14	6.83	4.97	2.64	
19.4	26.7	12.06	7.60	2.20	11.15	7.14	2.72	10.24	6.71	3.24	9.78	6.49	3.50	8.58	5.95	3.14	7.05	5.30	2.64	
22.0	30.0	12.73	7.25	2.23	11.82	6.85	2.74	10.91	6.46	3.26	10.46	6.27	3.52	9.23	5.78	3.14	7.70	5.20	2.64	
24.0	32.0	13.18	7.00	2.24	12.27	6.63	2.76	11.36	6.28	3.28	10.91	6.10	3.53	9.66	5.64	3.14	8.13	5.11	2.64	

Temp: Fahrenheit / TC, SHC: kBtu/h / PI: kW

INDOOR			OUTDOOR TEMPERATURE (°FDB)																	
EWB	EDB	50			68			86			95			104			115			
		°F	°F	TC	SHC	PI	TC	SHC	PI	TC	SHC	PI	TC	SHC	PI	TC	SHC	PI	TC	SHC
57.2	68.0	28.42	20.01	2.02	28.42	20.01	2.65	28.42	20.01	3.20	28.42	20.01	3.46	25.58	18.52	3.14	20.37	15.91	2.64	
60.8	71.6	34.90	22.36	2.13	34.90	22.36	2.69	32.62	21.15	3.21	31.06	20.35	3.47	27.06	18.35	3.14	21.84	15.89	2.64	
64.4	77.0	40.37	25.08	2.20	37.26	23.48	2.71	34.15	21.93	3.23	32.60	21.18	3.49	28.53	19.28	3.14	23.32	16.97	2.64	
67.0	80.0	41.14	25.92	2.20	38.03	24.38	2.72	34.92	22.88	3.24	33.20	22.16	3.50	29.27	20.31	3.14	24.05	18.08	2.64	
71.6	86.0	43.44	24.75	2.23	40.34	23.38	2.74	37.23	22.05	3.26	35.68	21.40	3.52	31.48	19.72	3.14	26.26	17.73	2.64	
75.2	89.6	44.98	23.90	2.24	41.87	22.64	2.76	38.77	21.42	3.28	37.21	20.83	3.53	32.95	19.26	3.14	27.73	17.44	2.64	

Cooling (60 Hz, 230 V)

AFR	25.92
BF	0.34

Temp: Celsius / TC, SHC, PI: kW

INDOOR			OUTDOOR TEMPERATURE (°CDB)																	
EWB	EDB	10			20			30			35			40			46			
		°C	°C	TC	SHC	PI	TC	SHC	PI	TC	SHC	PI	TC	SHC	PI	TC	SHC	PI	TC	SHC
14.0	20.0	8.33	5.87	2.21	8.33	5.87	2.90	8.33	5.87	3.46	8.33	5.87	3.74	7.74	5.55	3.43	6.11	4.73	2.89	
16.0	22.0	10.23	6.55	2.30	10.23	6.55	2.92	9.85	6.35	3.48	9.38	6.11	3.75	8.18	5.50	3.43	6.55	4.72	2.89	
18.0	25.0	12.19	7.54	2.37	11.26	7.05	2.93	10.32	6.58	3.49	9.85	6.35	3.77	8.63	5.77	3.43	6.99	5.04	2.89	
19.4	26.7	12.43	7.79	2.38	11.49	7.31	2.94	10.55	6.86	3.50	10.08	6.63	3.78	8.85	6.07	3.43	7.22	5.37	2.89	
22.0	30.0	13.12	7.43	2.41	12.18	7.01	2.97	11.25	6.60	3.53	10.78	6.41	3.81	9.51	5.89	3.43	7.88	5.27	2.89	
24.0	32.0	13.59	7.17	2.42	12.65	6.79	2.98	11.71	6.41	3.54	11.24	6.23	3.82	9.96	5.75	3.43	8.33	5.18	2.89	

Temp: Fahrenheit / TC, SHC: kBtu/h / PI: kW

INDOOR			OUTDOOR TEMPERATURE (°FDB)																	
EWB	EDB	50			68			86			95			104			115			
		°F	°F	TC	SHC	PI	TC	SHC	PI	TC	SHC	PI	TC	SHC	PI	TC	SHC	PI	TC	SHC
57.2	68.0	28.42	20.01	2.21	28.42	20.01	2.90	28.42	20.01	3.46	28.42	20.01	3.74	26.40	18.95	3.43	20.83	16.13	2.89	
60.8	71.6	34.90	22.36	2.30	34.90	22.36	2.92	33.62	21.68	3.48	32.02	20.84	3.75	27.92	18.77	3.43	22.35	16.12	2.89	
64.4	77.0	41.61	25.74	2.37	38.41	24.06	2.93	35.20	22.45	3.49	33.60	21.66	3.77	29.43	19.69	3.43	23.86	17.21	2.89	
67.0	80.0	42.40	26.57	2.38	39.20	24.95	2.94	35.99	23.39	3.50	34.40	22.63	3.78	30.19	20.71	3.43	24.62	18.31	2.89	
71.6	86.0	44.78	25.36	2.41	41.57	23.92	2.97	38.37	22.53	3.53	36.77	21.86	3.81	32.46	20.10	3.43	26.89	17.97	2.89	
75.2	89.6	46.36	24.47	2.42	43.16	23.15	2.98	39.96	21.88	3.54	38.35	21.26	3.82	33.98	19.63	3.43	28.41	17.67	2.89	

Symbols:

AFR	: Airflow rate	(m ³ /min.)
BF	: Bypass factor	
EWB	: Entering wet bulb temp.	(°C) / (°F)
EDB	: Entering dry bulb temp.	(°C) / (°F)
TC	: Total capacity	(kW) / (kBtu/h)
SHC	: Sensible heat capacity	(kW) / (kBtu/h)
PI	: Power input	(kW)

Notes:

- shows nominal (rated) capacities and power input.
- TC, PI and SHC must be calculated by interpolation using the figures in the above tables. (Figures out of the tables should not be used for calculation.)
- Capacities are based on the following conditions.
Corresponding refrigerant piping length : 25 ft (7.5 m)
Level difference : 0 ft (0 m)
- Airflow rate (AFR) and Bypass factor (BF) are tabulated above table.

7.2 Heat Pump

FTX30WVJU9 + RX30WMVJU9

Cooling (60 Hz, 208 V)

AFR	25.22
BF	0.34

Temp: Celsius / TC, SHC, PI: kW

INDOOR		OUTDOOR TEMPERATURE (°CDB)																	
EWB	EDB	10			20			30			35			40			46		
°C	°C	TC	SHC	PI	TC	SHC	PI	TC	SHC	PI	TC	SHC	PI	TC	SHC	PI	TC	SHC	PI
14.0	20.0	8.10	5.71	1.83	8.10	5.71	2.39	8.10	5.71	2.92	8.10	5.71	3.15	7.39	5.33	3.13	5.92	4.59	2.64
16.0	22.0	9.95	6.38	1.95	9.83	6.31	2.46	8.97	5.86	2.93	8.55	5.64	3.17	7.79	5.27	3.13	6.33	4.58	2.64
18.0	25.0	11.11	6.94	2.00	10.25	6.51	2.47	9.40	6.09	2.95	8.97	5.88	3.18	8.20	5.53	3.13	6.74	4.88	2.64
19.4	26.7	11.32	7.18	2.01	10.46	6.77	2.48	9.61	6.36	2.95	9.18	6.16	3.19	8.40	5.81	3.13	6.94	5.19	2.64
22.0	30.0	11.95	6.86	2.03	11.10	6.49	2.50	10.24	6.13	2.97	9.81	5.96	3.21	9.01	5.63	3.13	7.55	5.08	2.64
24.0	32.0	12.37	6.63	2.04	11.52	6.29	2.52	10.66	5.96	2.99	10.24	5.80	3.22	9.41	5.50	3.13	7.95	4.99	2.64

Temp: Fahrenheit / TC, SHC: kBtu/h / PI: kW

INDOOR		OUTDOOR TEMPERATURE (°FDB)																	
EWB	EDB	50			68			86			95			104			115		
°F	°F	TC	SHC	PI	TC	SHC	PI	TC	SHC	PI	TC	SHC	PI	TC	SHC	PI	TC	SHC	PI
57.2	68.0	27.65	19.47	1.83	27.65	19.47	2.39	27.65	19.47	2.92	27.65	19.47	3.15	25.20	18.18	3.13	20.21	15.67	2.64
60.8	71.6	33.96	21.76	1.95	33.53	21.53	2.46	30.62	20.00	2.93	29.16	19.26	3.17	26.58	17.98	3.13	21.60	15.62	2.64
64.4	77.0	37.89	23.68	2.00	34.98	22.20	2.47	32.06	20.77	2.95	30.60	20.08	3.18	27.97	18.85	3.13	22.98	16.64	2.64
67.0	80.0	38.61	24.51	2.01	35.70	23.08	2.48	32.78	21.70	2.95	31.40	21.03	3.19	28.66	19.84	3.13	23.68	17.70	2.64
71.6	86.0	40.78	23.42	2.03	37.86	22.15	2.50	34.95	20.92	2.97	33.49	20.32	3.21	30.74	19.23	3.13	25.75	17.33	2.64
75.2	89.6	42.22	22.62	2.04	39.31	21.46	2.52	36.39	20.33	2.99	34.93	19.79	3.22	32.12	18.76	3.13	27.14	17.02	2.64

Heating (60 Hz, 208 V)

AFR	27.2
-----	------

Temp: Celsius / TC, PI: kW

INDOOR		OUTDOOR TEMPERATURE (°CWB)													
EDB		-15		-10		-5		0		6		10		18	
°C		TC	PI	TC	PI	TC	PI	TC	PI	TC	PI	TC	PI	TC	PI
15.0		4.86	2.54	5.84	2.67	6.82	2.80	7.79	2.93	10.55	3.43	11.47	3.55	13.32	3.78
21.1		4.56	2.61	5.54	2.74	6.52	2.87	7.50	3.00	10.20	3.51	11.12	3.63	12.96	3.86
22.0		4.44	2.64	5.42	2.77	6.40	2.90	7.38	3.03	10.06	3.54	10.98	3.66	12.82	3.89
24.0		4.32	2.67	5.30	2.80	6.28	2.93	7.26	3.06	9.92	3.57	10.84	3.69	12.68	3.92
25.0		4.26	2.68	5.24	2.81	6.22	2.94	7.20	3.07	9.85	3.59	10.77	3.70	12.61	3.94
27.0		4.14	2.71	5.12	2.84	6.10	2.97	7.08	3.10	9.71	3.62	10.63	3.74	12.47	3.97

Temp: Fahrenheit / TC: kBtu/h / PI: kW

INDOOR		OUTDOOR TEMPERATURE (°FWB)													
EDB		5		14		23		32		43		50		64	
°F		TC	PI	TC	PI	TC	PI	TC	PI	TC	PI	TC	PI	TC	PI
59.0		16.57	2.54	19.91	2.67	23.25	2.80	26.59	2.93	36.00	3.43	39.15	3.55	45.44	3.78
70.0		15.55	2.61	18.89	2.74	22.23	2.87	25.57	3.00	34.80	3.51	37.95	3.63	44.23	3.86
71.6		15.14	2.64	18.48	2.77	21.82	2.90	25.17	3.03	34.32	3.54	37.47	3.66	43.75	3.89
75.2		14.74	2.67	18.08	2.80	21.42	2.93	24.76	3.06	33.84	3.57	36.99	3.69	43.27	3.92
77.0		14.53	2.68	17.87	2.81	21.21	2.94	24.55	3.07	33.60	3.59	36.74	3.70	43.03	3.94
80.6		14.12	2.71	17.46	2.84	20.80	2.97	24.14	3.10	33.12	3.62	36.26	3.74	42.55	3.97

Cooling (60 Hz, 230 V)

AFR	25.22
BF	0.34

Temp: Celsius / TC, SHC, PI: kW

INDOOR		OUTDOOR TEMPERATURE (°CDB)																	
EWB	EDB	10			20			30			35			40			46		
		TC	SHC	PI	TC	SHC	PI	TC	SHC	PI	TC	SHC	PI	TC	SHC	PI	TC	SHC	PI
14.0	20.0	8.10	5.71	1.83	8.10	5.71	2.39	8.10	5.71	2.92	8.10	5.71	3.15	7.70	5.49	3.39	6.26	4.76	2.92
16.0	22.0	9.95	6.38	1.95	9.83	6.31	2.46	8.97	5.86	2.93	8.55	5.64	3.17	8.12	5.43	3.40	6.67	4.74	2.92
18.0	25.0	11.11	6.94	2.00	10.25	6.51	2.47	9.40	6.09	2.95	8.97	5.88	3.18	8.54	5.68	3.42	7.08	5.02	2.92
19.4	26.7	11.32	7.18	2.01	10.46	6.77	2.48	9.61	6.36	2.95	9.18	6.16	3.19	8.75	5.97	3.42	7.28	5.33	2.92
22.0	30.0	11.95	6.86	2.03	11.10	6.49	2.50	10.24	6.13	2.97	9.81	5.96	3.21	9.39	5.78	3.44	7.89	5.21	2.92
24.0	32.0	12.37	6.63	2.04	11.52	6.29	2.52	10.66	5.96	2.99	10.24	5.80	3.22	9.81	5.64	3.46	8.29	5.11	2.92

Temp: Fahrenheit / TC, SHC: kBtu/h / PI: kW

INDOOR		OUTDOOR TEMPERATURE (°FDB)																	
EWB	EDB	50			68			86			95			104			115		
		TC	SHC	PI	TC	SHC	PI	TC	SHC	PI	TC	SHC	PI	TC	SHC	PI	TC	SHC	PI
57.2	68.0	27.65	19.47	1.83	27.65	19.47	2.39	27.65	19.47	2.92	27.65	19.47	3.15	26.26	18.73	3.39	21.38	16.24	2.92
60.8	71.6	33.96	21.76	1.95	33.53	21.53	2.46	30.62	20.00	2.93	29.16	19.26	3.17	27.70	18.53	3.40	22.76	16.16	2.92
64.4	77.0	37.89	23.68	2.00	34.98	22.20	2.47	32.06	20.77	2.95	30.60	20.08	3.18	29.14	19.39	3.42	24.14	17.14	2.92
67.0	80.0	38.61	24.51	2.01	35.70	23.08	2.48	32.78	21.70	2.95	31.40	21.03	3.19	29.86	20.37	3.42	24.84	18.19	2.92
71.6	86.0	40.78	23.42	2.03	37.86	22.15	2.50	34.95	20.92	2.97	33.49	20.32	3.21	32.03	19.74	3.44	26.91	17.76	2.92
75.2	89.6	42.22	22.62	2.04	39.31	21.46	2.52	36.39	20.33	2.99	34.93	19.79	3.22	33.47	19.25	3.46	28.30	17.42	2.92

Heating (60 Hz, 230 V)

AFR	27.2
-----	------

Temp: Celsius / TC, PI: kW

INDOOR		OUTDOOR TEMPERATURE (°CWB)													
EDB	°C	-15		-10		-5		0		6		10		18	
		TC	PI	TC	PI	TC	PI	TC	PI	TC	PI	TC	PI	TC	PI
15.0	4.86	2.54	5.84	2.67	6.82	2.80	7.79	2.93	10.55	3.43	11.47	3.55	13.32	3.78	
21.1	4.56	2.61	5.54	2.74	6.52	2.87	7.50	3.00	10.20	3.51	11.12	3.63	12.96	3.86	
22.0	4.44	2.64	5.42	2.77	6.40	2.90	7.38	3.03	10.06	3.54	10.98	3.66	12.82	3.89	
24.0	4.32	2.67	5.30	2.80	6.28	2.93	7.26	3.06	9.92	3.57	10.84	3.69	12.68	3.92	
25.0	4.26	2.68	5.24	2.81	6.22	2.94	7.20	3.07	9.85	3.59	10.77	3.70	12.61	3.94	
27.0	4.14	2.71	5.12	2.84	6.10	2.97	7.08	3.10	9.71	3.62	10.63	3.74	12.47	3.97	

Temp: Fahrenheit / TC: kBtu/h / PI: kW

INDOOR		OUTDOOR TEMPERATURE (°FWB)													
EDB	°F	5		14		23		32		43		50		64	
		TC	PI	TC	PI	TC	PI	TC	PI	TC	PI	TC	PI	TC	PI
59.0	16.57	2.54	19.91	2.67	23.25	2.80	26.59	2.93	36.00	3.43	39.15	3.55	45.44	3.78	
70.0	15.55	2.61	18.89	2.74	22.23	2.87	25.57	3.00	34.80	3.51	37.95	3.63	44.23	3.86	
71.6	15.14	2.64	18.48	2.77	21.82	2.90	25.17	3.03	34.32	3.54	37.47	3.66	43.75	3.89	
75.2	14.74	2.67	18.08	2.80	21.42	2.93	24.76	3.06	33.84	3.57	36.99	3.69	43.27	3.92	
77.0	14.53	2.68	17.87	2.81	21.21	2.94	24.55	3.07	33.60	3.59	36.74	3.70	43.03	3.94	
80.6	14.12	2.71	17.46	2.84	20.80	2.97	24.14	3.10	33.12	3.62	36.26	3.74	42.55	3.97	

Symbols:

AFR	: Airflow rate	(m ³ /min.)
BF	: Bypass factor	
EWB	: Entering wet bulb temp.	(°C) / (°F)
EDB	: Entering dry bulb temp.	(°C) / (°F)
TC	: Total capacity	(kW) / (kBtu/h)
SHC	: Sensible heat capacity	(kW) / (kBtu/h)
PI	: Power input	(kW)

Notes:

- shows nominal (rated) capacities and power input.
- TC, PI and SHC must be calculated by interpolation using the figures in the above tables. (Figures out of the tables should not be used for calculation.)
- Capacities are based on the following conditions.
Corresponding refrigerant piping length : 25 ft (7.5 m)
Level difference : 0 ft (0 m)
- Airflow rate (AFR) and Bypass factor (BF) are tabulated above table.

FTX36WVJU9 + RX36WMVJU9

Cooling (60 Hz, 208 V)

AFR	25.92
BF	0.34

Temp: Celsius / TC, SHC, PI: kW

INDOOR		OUTDOOR TEMPERATURE (°CDB)																	
EWB	EDB	10			20			30			35			40			46		
°C	°C	TC	SHC	PI	TC	SHC	PI	TC	SHC	PI	TC	SHC	PI	TC	SHC	PI	TC	SHC	PI
14.0	20.0	8.33	5.87	2.02	8.33	5.87	2.65	8.33	5.87	3.20	8.33	5.87	3.46	7.50	5.43	3.14	5.97	4.66	2.64
16.0	22.0	10.23	6.55	2.13	10.23	6.55	2.69	9.56	6.20	3.21	9.10	5.96	3.47	7.93	5.38	3.14	6.40	4.66	2.64
18.0	25.0	11.83	7.35	2.20	10.92	6.88	2.71	10.01	6.43	3.23	9.55	6.21	3.49	8.36	5.65	3.14	6.83	4.97	2.64
19.4	26.7	12.06	7.60	2.20	11.15	7.14	2.72	10.24	6.71	3.24	9.78	6.49	3.50	8.58	5.95	3.14	7.05	5.30	2.64
22.0	30.0	12.73	7.25	2.23	11.82	6.85	2.74	10.91	6.46	3.26	10.46	6.27	3.52	9.23	5.78	3.14	7.70	5.20	2.64
24.0	32.0	13.18	7.00	2.24	12.27	6.63	2.76	11.36	6.28	3.28	10.91	6.10	3.53	9.66	5.64	3.14	8.13	5.11	2.64

Temp: Fahrenheit / TC, SHC: kBtu/h / PI: kW

INDOOR		OUTDOOR TEMPERATURE (°FDB)																	
EWB	EDB	50			68			86			95			104			115		
°F	°F	TC	SHC	PI	TC	SHC	PI	TC	SHC	PI	TC	SHC	PI	TC	SHC	PI	TC	SHC	PI
57.2	68.0	28.42	20.01	2.02	28.42	20.01	2.65	28.42	20.01	3.20	28.42	20.01	3.46	25.58	18.52	3.14	20.37	15.91	2.64
60.8	71.6	34.90	22.36	2.13	34.90	22.36	2.69	32.62	21.15	3.21	31.06	20.35	3.47	27.06	18.35	3.14	21.84	15.89	2.64
64.4	77.0	40.37	25.08	2.20	37.26	23.48	2.71	34.15	21.93	3.23	32.60	21.18	3.49	28.53	19.28	3.14	23.32	16.97	2.64
67.0	80.0	41.14	25.92	2.20	38.03	24.38	2.72	34.92	22.88	3.24	33.20	22.16	3.50	29.27	20.31	3.14	24.05	18.08	2.64
71.6	86.0	43.44	24.75	2.23	40.34	23.38	2.74	37.23	22.05	3.26	35.68	21.40	3.52	31.48	19.72	3.14	26.26	17.73	2.64
75.2	89.6	44.98	23.90	2.24	41.87	22.64	2.76	38.77	21.42	3.28	37.21	20.83	3.53	32.95	19.26	3.14	27.73	17.44	2.64

Heating (60 Hz, 208 V)

AFR	27.2
-----	------

Temp: Celsius / TC, PI: kW

INDOOR		OUTDOOR TEMPERATURE (°CWB)													
EDB		-15		-10		-5		0		6		10		18	
°C		TC	PI	TC	PI	TC	PI	TC	PI	TC	PI	TC	PI	TC	PI
15.0		4.91	2.72	5.91	2.86	6.90	3.00	7.89	3.14	10.68	3.68	11.61	3.80	13.47	4.05
21.1		4.61	2.80	5.60	2.94	6.59	3.08	7.58	3.22	10.32	3.76	11.25	3.88	13.12	4.13
22.0		4.49	2.83	5.48	2.97	6.47	3.11	7.46	3.25	10.18	3.79	11.11	3.92	12.97	4.17
24.0		4.37	2.86	5.36	3.00	6.35	3.14	7.34	3.28	10.04	3.83	10.97	3.95	12.83	4.20
25.0		4.31	2.87	5.30	3.01	6.29	3.15	7.28	3.29	9.96	3.84	10.90	3.97	12.76	4.22
27.0		4.19	2.91	5.18	3.04	6.17	3.18	7.16	3.32	9.82	3.88	10.75	4.00	12.62	4.25

Temp: Fahrenheit / TC: kBtu/h / PI: kW

INDOOR		OUTDOOR TEMPERATURE (°FWB)													
EDB		5		14		23		32		43		50		64	
°F		TC	PI	TC	PI	TC	PI	TC	PI	TC	PI	TC	PI	TC	PI
59.0		16.77	2.72	20.15	2.86	23.53	3.00	26.91	3.14	36.43	3.68	39.61	3.80	45.97	4.05
70.0		15.74	2.80	19.12	2.94	22.49	3.08	25.87	3.22	35.20	3.76	38.39	3.88	44.75	4.13
71.6		15.32	2.83	18.70	2.97	22.08	3.11	25.46	3.25	34.73	3.79	37.91	3.92	44.27	4.17
75.2		14.91	2.86	18.29	3.00	21.67	3.14	25.05	3.28	34.24	3.83	37.42	3.95	43.78	4.20
77.0		14.70	2.87	18.08	3.01	21.46	3.15	24.84	3.29	34.00	3.84	37.18	3.97	43.54	4.22
80.6		14.29	2.91	17.67	3.04	21.05	3.18	24.43	3.32	33.51	3.88	36.69	4.00	43.05	4.25

Cooling (60 Hz, 230 V)

AFR	25.92
BF	0.34

Temp: Celsius / TC, SHC, PI: kW

INDOOR		OUTDOOR TEMPERATURE (°CDB)																	
EWB	EDB	10			20			30			35			40			46		
		TC	SHC	PI	TC	SHC	PI	TC	SHC	PI	TC	SHC	PI	TC	SHC	PI	TC	SHC	PI
14.0	20.0	8.33	5.87	2.21	8.33	5.87	2.90	8.33	5.87	3.46	8.33	5.87	3.74	7.74	5.55	3.43	6.11	4.73	2.89
16.0	22.0	10.23	6.55	2.30	10.23	6.55	2.92	9.85	6.35	3.48	9.38	6.11	3.75	8.18	5.50	3.43	6.55	4.72	2.89
18.0	25.0	12.19	7.54	2.37	11.26	7.05	2.93	10.32	6.58	3.49	9.85	6.35	3.77	8.63	5.77	3.43	6.99	5.04	2.89
19.4	26.7	12.43	7.79	2.38	11.49	7.31	2.94	10.55	6.86	3.50	10.08	6.63	3.78	8.85	6.07	3.43	7.22	5.37	2.89
22.0	30.0	13.12	7.43	2.41	12.18	7.01	2.97	11.25	6.60	3.53	10.78	6.41	3.81	9.51	5.89	3.43	7.88	5.27	2.89
24.0	32.0	13.59	7.17	2.42	12.65	6.79	2.98	11.71	6.41	3.54	11.24	6.23	3.82	9.96	5.75	3.43	8.33	5.18	2.89

Temp: Fahrenheit / TC, SHC: kBtu/h / PI: kW

INDOOR		OUTDOOR TEMPERATURE (°FDB)																	
EWB	EDB	50			68			86			95			104			115		
		TC	SHC	PI	TC	SHC	PI	TC	SHC	PI	TC	SHC	PI	TC	SHC	PI	TC	SHC	PI
57.2	68.0	28.42	20.01	2.21	28.42	20.01	2.90	28.42	20.01	3.46	28.42	20.01	3.74	26.40	18.95	3.43	20.83	16.13	2.89
60.8	71.6	34.90	22.36	2.30	34.90	22.36	2.92	33.62	21.68	3.48	32.02	20.84	3.75	27.92	18.77	3.43	22.35	16.12	2.89
64.4	77.0	41.61	25.74	2.37	38.41	24.06	2.93	35.20	22.45	3.49	33.60	21.66	3.77	29.43	19.69	3.43	23.86	17.21	2.89
67.0	80.0	42.40	26.57	2.38	39.20	24.95	2.94	35.99	23.39	3.50	34.40	22.63	3.78	30.19	20.71	3.43	24.62	18.31	2.89
71.6	86.0	44.78	25.36	2.41	41.57	23.92	2.97	38.37	22.53	3.53	36.77	21.86	3.81	32.46	20.10	3.43	26.89	17.97	2.89
75.2	89.6	46.36	24.47	2.42	43.16	23.15	2.98	39.96	21.88	3.54	38.35	21.26	3.82	33.98	19.63	3.43	28.41	17.67	2.89

Heating (60 Hz, 230 V)

AFR	27.2
-----	------

Temp: Celsius / TC, PI: kW

INDOOR		OUTDOOR TEMPERATURE (°CWB)													
EDB	°C	-15		-10		-5		0		6		10		18	
		TC	PI	TC	PI	TC	PI	TC	PI	TC	PI	TC	PI	TC	PI
15.0	5.03	2.81	6.04	2.95	7.06	3.10	8.07	3.24	10.92	3.79	11.88	3.92	13.79	4.18	
21.1	4.72	2.89	5.73	3.03	6.75	3.18	7.76	3.32	10.56	3.88	11.51	4.01	13.42	4.27	
22.0	4.60	2.92	5.61	3.06	6.62	3.21	7.64	3.35	10.41	3.92	11.37	4.04	13.28	4.30	
24.0	4.47	2.95	5.48	3.10	6.50	3.24	7.51	3.38	10.27	3.95	11.22	4.08	13.13	4.34	
25.0	4.41	2.97	5.42	3.11	6.44	3.26	7.45	3.40	10.20	3.97	11.15	4.10	13.06	4.35	
27.0	4.29	3.00	5.30	3.14	6.31	3.29	7.33	3.43	10.05	4.00	11.00	4.13	12.91	4.39	

Temp: Fahrenheit / TC: kBtu/h / PI: kW

INDOOR		OUTDOOR TEMPERATURE (°FWB)													
EDB	°F	5		14		23		32		43		50		64	
		TC	PI	TC	PI	TC	PI	TC	PI	TC	PI	TC	PI	TC	PI
59.0	17.16	2.81	20.62	2.95	24.08	3.10	27.53	3.24	37.27	3.79	40.53	3.92	47.04	4.18	
70.0	16.10	2.89	19.56	3.03	23.02	3.18	26.48	3.32	36.00	3.88	39.29	4.01	45.80	4.27	
71.6	15.68	2.92	19.14	3.06	22.60	3.21	26.05	3.35	35.53	3.92	38.79	4.04	45.30	4.30	
75.2	15.26	2.95	18.71	3.10	22.17	3.24	25.63	3.38	35.04	3.95	38.29	4.08	44.80	4.34	
77.0	15.04	2.97	18.50	3.11	21.96	3.26	25.42	3.40	34.79	3.97	38.04	4.10	44.55	4.35	
80.6	14.62	3.00	18.08	3.14	21.54	3.29	25.00	3.43	34.29	4.00	37.54	4.13	44.05	4.39	

Symbols:

AFR	: Airflow rate	(m ³ /min.)
BF	: Bypass factor	
EWB	: Entering wet bulb temp.	(°C) / (°F)
EDB	: Entering dry bulb temp.	(°C) / (°F)
TC	: Total capacity	(kW) / (kBtu/h)
SHC	: Sensible heat capacity	(kW) / (kBtu/h)
PI	: Power input	(kW)

Notes:

- shows nominal (rated) capacities and power input.
- TC, PI and SHC must be calculated by interpolation using the figures in the above tables. (Figures out of the tables should not be used for calculation.)
- Capacities are based on the following conditions.
Corresponding refrigerant piping length : 25 ft (7.5 m)
Level difference : 0 ft (0 m)
- Airflow rate (AFR) and Bypass factor (BF) are tabulated above table.

7.3 Capacity Correction Factor by the Length of Refrigerant Piping (Reference)

The cooling capacity and the heating capacity of the unit have to be corrected in accordance with the length of refrigerant piping — the distance between the indoor unit and the outdoor unit.

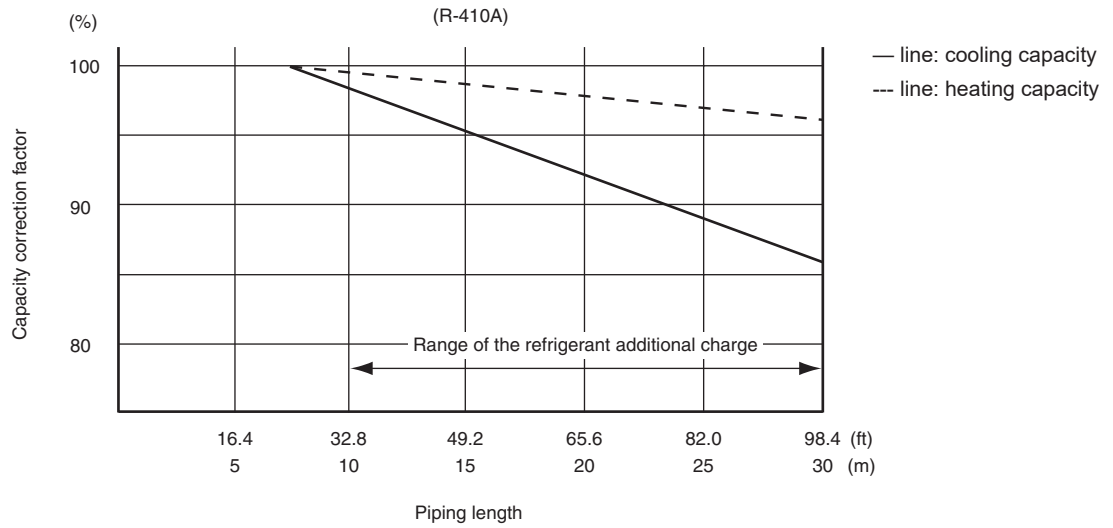

Note: The graphs show the factor when additional refrigerant of the proper quantity is charged.

8. Operation Limit

RK30/36WMVJU9

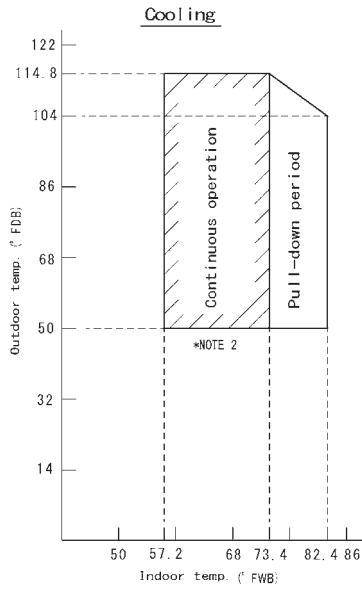

Notes:

- The graphs are based on the following conditions.
 - Equivalent piping length 25ft
 - Level difference 0ft
 - Air flow rate High
- Facility Setting (cooling at low outdoor temperature)
 This function is limited only for facilities (the target of air conditioning is equipment such as computer).
 Never use it in a residence or office (the space where is a human).
 Refer to the installation manual in detail of setting.

4D108219A

RX30/36WMVJU9

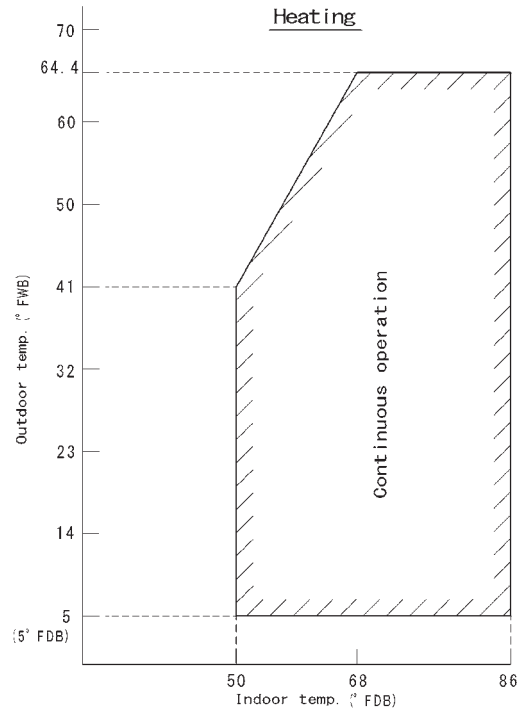
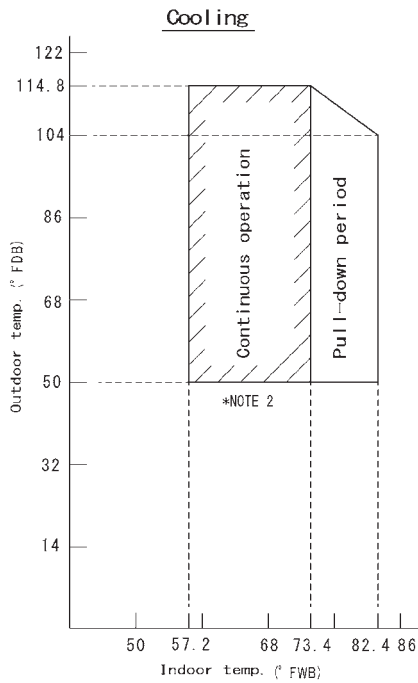

Notes:

- The graphs are based on the following conditions.
 - Equivalent piping length 25ft
 - Level difference 0ft
 - Air flow rate High
- Facility Setting (cooling at low outdoor temperature)
 This function is limited only for facilities (the target of air conditioning is equipment such as computer).
 Never use it in a residence or office (the space where is a human).
 Refer to the installation manual in detail of setting.

3D108218A

9. Sound Level

9.1 Measuring Location

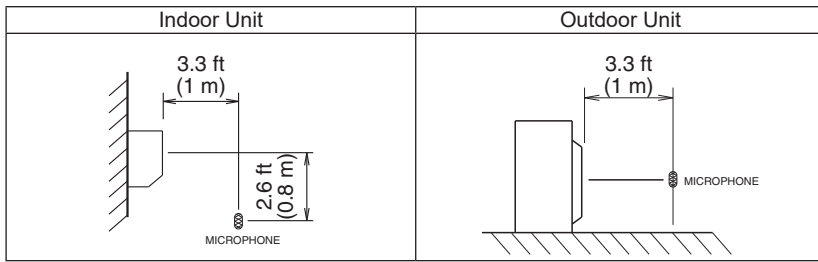

- Notes:**
1. Operation sound is measured in an anechoic chamber.
 2. The operation sound measuring method is based on JIS standard.

9.2 Indoor Unit FTX30WVJU9

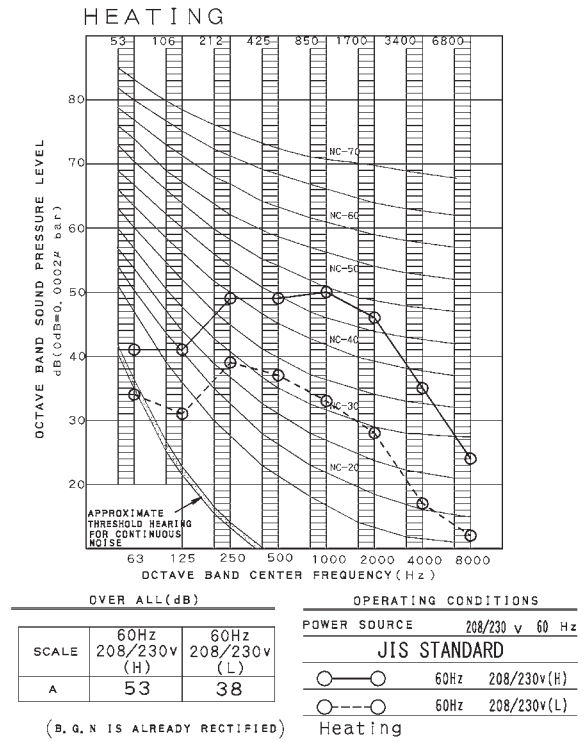
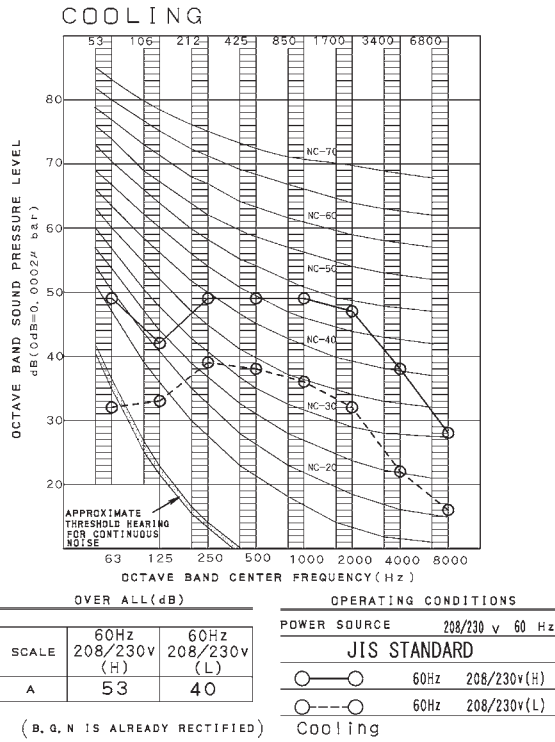

3D108154

FTX36WVJU9

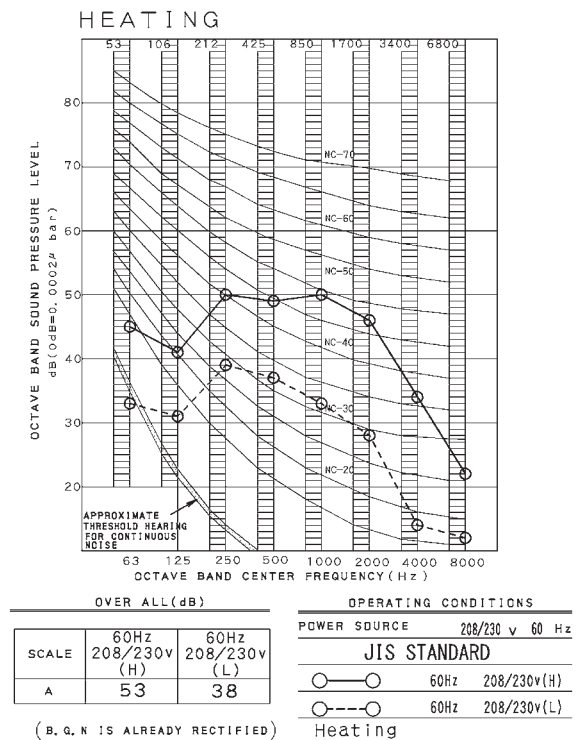
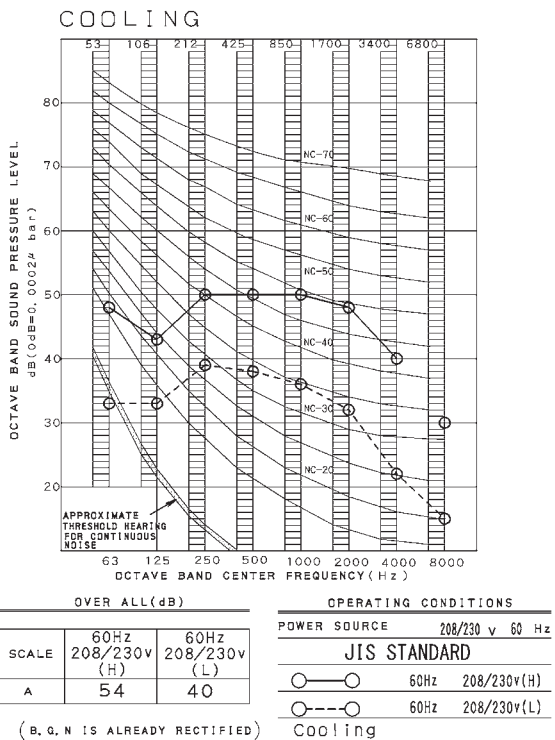

3D108155

9.3 Outdoor Unit RK30WMVJU9

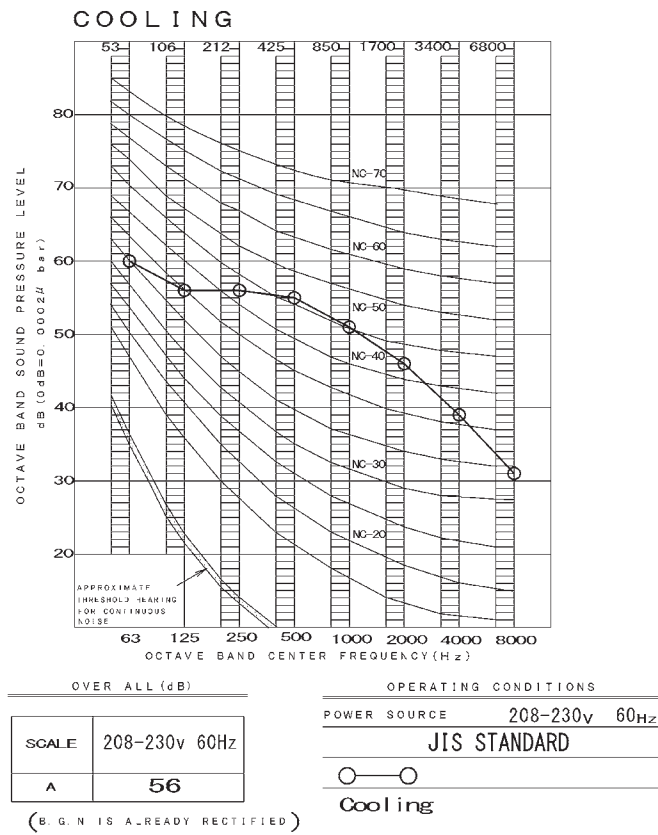

4D108166A

RK36WMVJU9

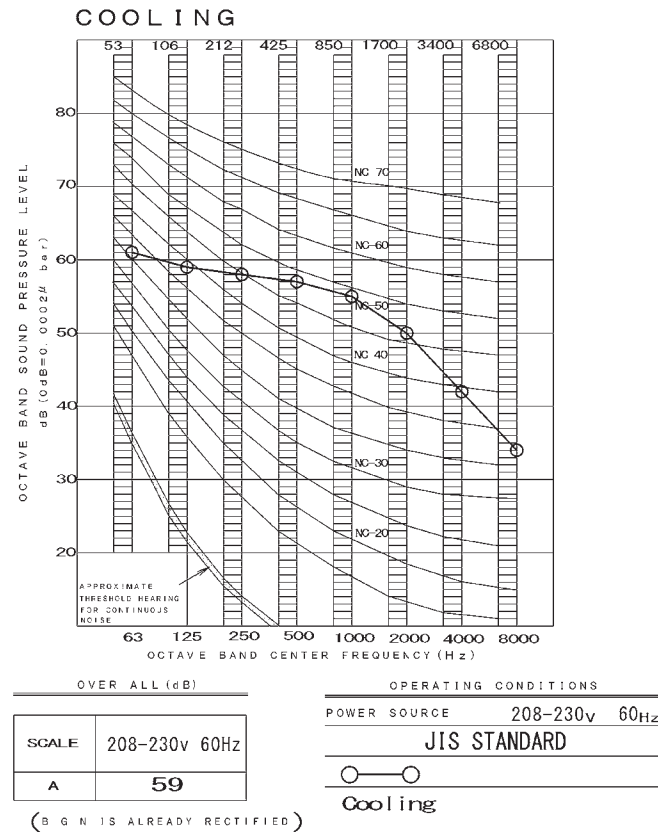

4D108167A

RX30WMVJU9

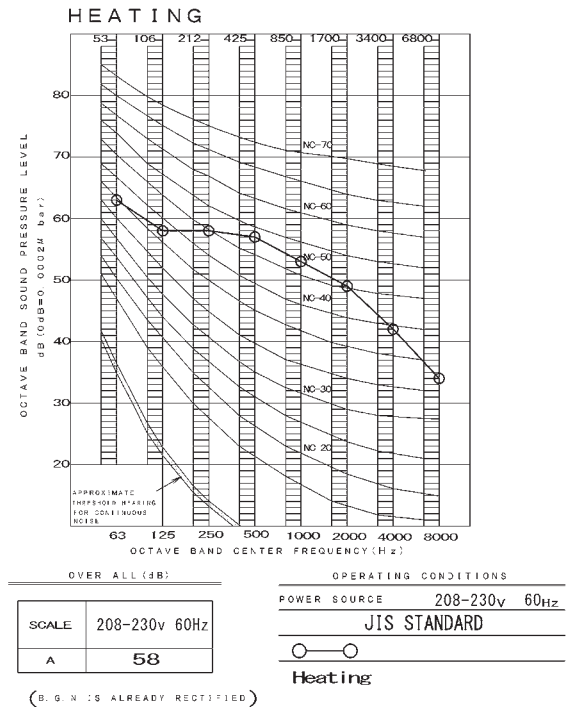
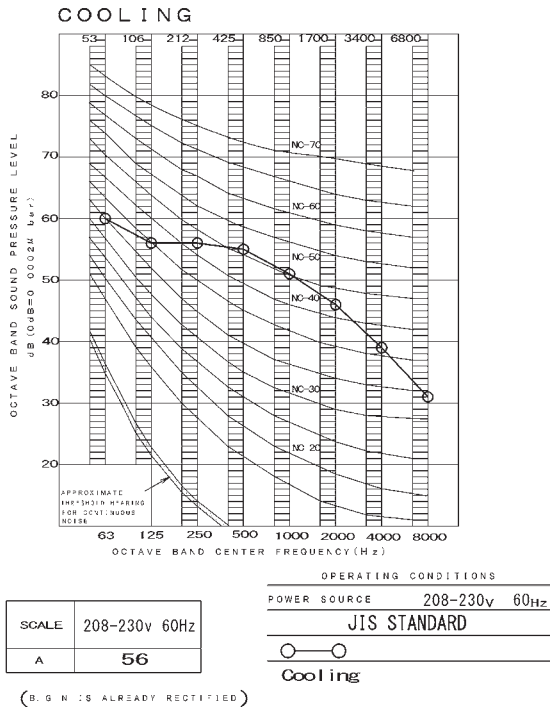

3D108159A

RX36WMVJU9

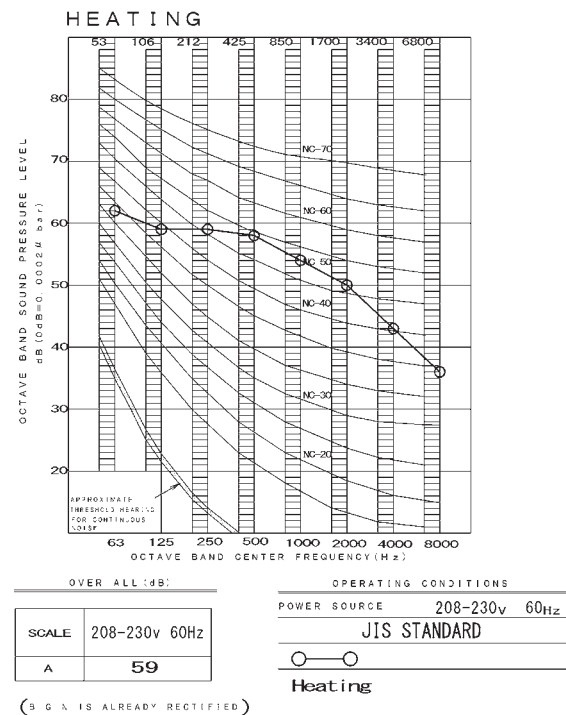
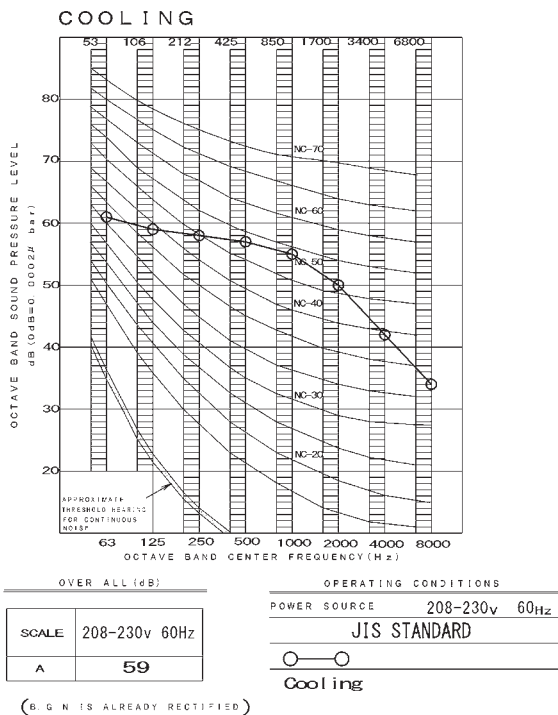

3D108160A

10. Electric Characteristics

Indoor Unit	Outdoor Unit	Power Supply				Compressor	OFM			IFM		
		Hz - Volts	Voltage Range	MCA	MFA	RLA	Hp	W	FLA	Hp	W	FLA
FTX30WVJU9	RK30WMVJU9	60 Hz - 208 V 60 Hz - 230 V	Max. 60 Hz, 253 V Min. 60 Hz, 187 V	16.6	20	16.3	0.16	122	0.77	0.09	64	0.37
FTX36WVJU9	RK36WMVJU9	60 Hz - 208 V 60 Hz - 230 V	Max. 60 Hz, 253 V Min. 60 Hz, 187 V	16.6	20	16.3	0.16	122	0.77	0.09	64	0.37
FTX30WVJU9	RX30WMVJU9	60 Hz - 208 V 60 Hz - 230 V	Max. 60 Hz, 253 V Min. 60 Hz, 187 V	18.6	20	18.3	0.16	122	0.77	0.09	64	0.37
FTX36WVJU9	RX36WMVJU9	60 Hz - 208 V 60 Hz - 230 V	Max. 60 Hz, 253 V Min. 60 Hz, 187 V	18.6	20	18.3	0.16	122	0.77	0.09	64	0.37

Symbols:

MCA	: Min. circuit amps	(A)
MFA	: Max. fuse amps	(A)
RLA	: Rated load amps	(A)
OFM	: Outdoor fan motor	
IFM	: Indoor fan motor	
FLA	: Full load amps	(A)
W / Hp	: Fan motor rated output	(W, Hp)

Notes:

1. RLA is the max current that comes in cooling operation and heating operation.
2. Maximum allowable voltage variation between phases is 2%.
3. Select wire size based on the larger value of MCA.

C: 3D143129

11. Installation Manual

11.1 Indoor Unit

Contents

Safety Considerations	1	Refrigerant Piping Work	9
Accessories	3	1. Flaring the pipe end	9
Choosing an Installation Site	3	2. Refrigerant piping.....	9
1. Indoor unit.....	3	Installation Tips	10
2. Wireless remote controller	3	1. Removing and installing the front panel.....	10
Indoor Unit Installation Diagram	4	2. Removing and installing the front grille	10
Indoor Unit Installation	5	3. How to set the different addresses	11
1. Installing the mounting plate	5	4. When connecting to an HA system.....	11
2. Drilling a wall hole and installing wall embedded pipe....	5	Trial Operation and Testing	12
3. Installing the indoor unit.....	5	1. Trial operation and testing	12
4. Wiring.....	7	2. Test items	12
5. Drain piping.....	8		

The pictures in this document are for illustrative purposes only.

Safety Considerations

Refer also to the General Safety Considerations in the separate booklet.

Read the precautions in this manual carefully before operating the unit.

Read these **Safety Considerations for Installation** carefully before installing an air conditioner or heat pump. After completing the installation, make sure that the unit operates properly during the startup operation. Instruct the user on how to operate and maintain the unit. Inform users that they should store this installation manual with the operation manual for future reference. Always use a licensed installer or contractor to install this product. Improper installation can result in water or refrigerant leakage, electric shock, fire, or explosion.

Meanings of **DANGER**, **WARNING**, **CAUTION**, and **NOTE** Symbols:

- DANGER**Indicates an imminently hazardous situation which, if not avoided, will result in death or serious injury.
- WARNING**Indicates a potentially hazardous situation which, if not avoided, could result in death or serious injury.
- CAUTION**Indicates a potentially hazardous situation which, if not avoided, may result in minor or moderate injury. It may also be used to alert against unsafe practices.
- NOTE**Indicates situations that may result in equipment or property damage accidents only.

- DANGER**
- Refrigerant gas is heavier than air and replaces oxygen. A massive leak can lead to oxygen depletion, especially in basements, and an asphyxiation hazard could occur leading to serious injury or death.
 - Do not ground units to water pipes, gas pipes, telephone wires, or lightning rods as incomplete grounding can cause a severe shock hazard resulting in severe injury or death. Additionally, grounding to gas pipes could cause a gas leak and potential explosion causing severe injury or death.

- If refrigerant gas leaks during installation, ventilate the area immediately. Refrigerant gas may produce toxic gas if it comes into contact with fire. Exposure to this gas could cause severe injury or death.
- After completing the installation work, check that the refrigerant gas does not leak throughout the system.
- Do not install unit in an area where flammable materials are present due to risk of explosions that can cause serious injury or death.
- Safely dispose all packing and transportation materials in accordance with federal/state/local laws or ordinances. Packing materials such as nails and other metal or wood parts, including plastic packing materials used for transportation may cause injuries or death by suffocation.

WARNING

- Only qualified personnel licensed or certified in their jurisdiction must carry out the installation work. Installation must be done in accordance with this installation manual. Improper installation may result in water leakage, electric shock, or fire.
- When installing the unit in a small room, take measures to keep the refrigerant concentration from exceeding allowable safety limits. Excessive refrigerant leaks, in the event of an accident in a closed ambient space, can lead to oxygen deficiency.
- Use only specified accessories and parts for installation work. Failure to use specified parts may result in water leakage, electric shock, fire, or the unit falling.
- Install the air conditioner or heat pump on a foundation strong enough that it can withstand the weight of the unit. A foundation of insufficient strength may result in the unit falling and causing injuries.
- Take into account strong winds, typhoons, or earthquakes when installing. Improper installation may result in the unit falling and causing accidents.
- Make sure that a separate power supply circuit is provided for this unit and that all electrical work is carried out by qualified personnel licensed or certified in their jurisdiction according to local, state, and national regulations. An insufficient power supply capacity or improper electrical construction may lead to electric shock or fire.
- Make sure that all wiring is secured, that specified wires are used, and that no external forces act on the terminal connections or wires. Improper connections or installation may result in fire.

- When wiring, position the wires so that the electrical wiring box cover can be securely fastened. Improper positioning of the electrical wiring box cover may result in electric shock, fire, or the terminals overheating.
- Before touching electrical parts, turn off the unit.
- The circuit must be protected with safety devices in accordance with local and national codes, i.e. a circuit breaker.
- Securely fasten the outdoor unit terminal cover (panel). If the terminal cover/panel is not installed properly, dust or water may enter the outdoor unit causing fire or electric shock.
- When installing or relocating the system, keep the refrigerant circuit free from substances other than the specified refrigerant (R410A) such as air. Any presence of air or other foreign substance in the refrigerant circuit can cause an abnormal pressure rise or rupture, resulting in equipment damage and even injury.
- Do not change the setting of the protection devices. If the pressure switch, thermal switch, or other protection device is shorted and operated forcibly, or parts other than those specified by Daikin are used, fire or explosion may occur.
- Do not use means to accelerate the defrosting process (if possible) or to clean, other than those recommended by the manufacturer.
- The appliance must be stored in a room without continuously operating ignition sources (for example: open flames, an operating gas appliance or an operating electric heater).
- Do not pierce or burn.
- Be aware that refrigerants may not contain an odor.
- Comply with national gas regulations.

 **CAUTION**

- Do not touch the switch with wet fingers. Touching a switch with wet fingers can cause electric shock.
- Do not allow children to play on or around the unit to prevent injury.
- Wear adequate personal protective equipment (protective gloves, safety glasses,...) when installing, maintaining or servicing the system.
- The heat exchanger fins are sharp enough to cut. To avoid injury, wear gloves or cover the fins while working around them.
- Do not touch the refrigerant pipes during and immediately after operation as the refrigerant pipes may be hot or cold, depending on the condition of the refrigerant flowing through the refrigerant piping, compressor, and other refrigerant cycle parts. Your hands may suffer burns or frostbite if you touch the refrigerant pipes. To avoid injury, give the pipes time to return to normal temperature or, if you must touch them, be sure to wear proper gloves.
- Install drain piping to ensure proper drainage. Improper drain piping may result in water leakage and property damage.
- Insulate piping to prevent condensation.
- Be careful when transporting the product.
- Do not turn off the power immediately after stopping operation. Always wait for at least 5 minutes before turning off the power. Otherwise, water leakage may occur.
- Do not use a charging cylinder. Using a charging cylinder may cause the refrigerant to deteriorate.
- Refrigerant R410A in the system must be kept clean, dry, and tight.

- (a) Clean and Dry -- Foreign materials (including mineral oils such as SUNISO oil or moisture) should be prevented from getting into the system.

- (b) Tight -- R410A does not contain any chlorine, does not destroy the ozone layer, and does not reduce the earth's protection against harmful ultraviolet radiation. R410A can contribute to the greenhouse effect if it is released. Therefore take proper measures to check for the tightness of the refrigerant piping installation. Read the chapter *Refrigerant Piping Work* and follow the procedures.
- Since R410A is a blend, the required additional refrigerant must be charged in its liquid state. If the refrigerant is charged in a state of gas, its composition can change and the system will not work properly.
- The indoor unit is for R410A. See the catalog for outdoor models that can be connected. Normal operation is not possible when connected to non-compatible outdoor units.
- Remote controller (wireless kit) transmitting distance can be shorter than expected in rooms with electronic fluorescent lamps (inverter or rapid start types). Install the indoor unit far away from fluorescent lamps as much as possible.
- Indoor units are for indoor installation only. Outdoor units can be installed either outdoors or indoors.
- Do not install the air conditioner or heat pump in the following locations:
 - (a) Where a mineral oil mist or oil spray or vapor is produced, for example, in a kitchen. Plastic parts may deteriorate and fall off or result in water leakage.
 - (b) Where corrosive gas, such as sulfurous acid gas, is produced. Corroding copper pipes or soldered parts may result in refrigerant leakage.
 - (c) Near machinery emitting electromagnetic waves. Electromagnetic waves may disturb the operation of the control system and cause the unit to malfunction.
 - (d) Where flammable gas may leak, where there is carbon fiber, or ignitable dust suspension in the air, or where volatile flammables such as thinner or gasoline are handled. Operating the unit in such conditions can cause a fire.
- Take adequate measures to prevent the outdoor unit from being used as a shelter by small animals. Small animals making contact with electrical parts can cause malfunctions, smoke, or fire. Instruct the user to keep the area around the unit clean.
- Servicing shall be performed only as recommended by the manufacturer and licensed or certified in their jurisdiction.









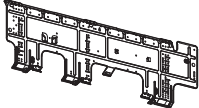

 **NOTE**

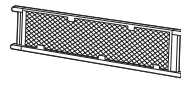
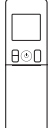
- The indoor unit should be positioned where the unit and inter-unit wires (outdoor to indoor) are at least 3.3ft (1m) away from any televisions or radios. (The unit may cause interference with the picture or sound.) Depending on the radio waves, a distance of 3.3ft (1m) may not be sufficient to eliminate the noise.
- Dismantling the unit, treatment of the refrigerant, oil and additional parts must be done in accordance with the relevant local, state, and national regulations.
- Only use tools for R410A, such as a gauge manifold, charge hose, gas leak detector, reverse flow check valve, refrigerant charge base, vacuum gauge, or refrigerant recovery equipment.
- If the conventional refrigerant and refrigerator oil are mixed in R410A, the refrigerant may deteriorate.
- This air conditioner or heat pump is an appliance that should not be accessible to the general public.
- As maximum allowable pressure is 604psi (4.17MPa), the wall thickness of field-installed pipes should be selected in accordance with the relevant local, state, and national regulations.

FTN005-U

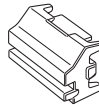
2

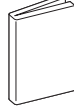
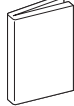
Accessories

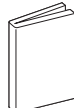
(A) Mounting plate 	1	(B) Mounting plate fixing screw M4 × 1" (M4 × 25mm) 	9	(C) Titanium apatite photocatalytic air-purifying filter 	3
(D) Wireless remote controller 	1	(E) Remote controller holder 	1	(F) Remote controller holder fixing screw M3 × 13/16" (M3 × 20mm) 	2
(G) Dry battery AAA. LR03 (alkaline) 	2	(H) Indoor unit fixing screw M4 × 1/2" (M4 × 12mm) 	3	(J) Screw cover 	3
(K) Tube 	1	(L) Operation manual 	1	(M) Installation manual 	1
(N) Warranty 	1	(P) General safety considerations 	1		

Choosing an Installation Site

Before choosing the installation site, obtain user approval.

1. Indoor unit

- The indoor unit should be positioned in a place where:
 - 1) the restrictions on the installation requirements specified in "**Indoor Unit Installation Diagram**" on page 4 are met,
 - 2) both the air inlet and air outlet are unobstructed,
 - 3) the unit is not exposed to direct sunlight,
 - 4) Install so that drainage occurs easily,
 - 5) the unit is away from sources of heat or steam,
 - 6) there is no source of machine oil vapor (this may shorten the indoor unit service life),
 - 7) cool/warm air is circulated throughout the room,
 - 8) the unit is away from electronic ignition type fluorescent lamps (inverter or rapid start type) as they may affect the remote controller range,
 - 9) the unit is at least 3.3ft (1m) away from any television or radio set (the unit may cause interference with the picture or sound),
 - 10) no laundry equipment is nearby.

2. Wireless remote controller

- 1) Turn on all the fluorescent lamps in the room, if any, and find a location where the remote controller signals are properly received by the indoor unit (within 23ft (7m)).
- 2) Configure the jumper. Configure according to the type of unit (heat pump or cooling only) the user purchased. The default setting is heat pump.
 - **For heat pump (outdoor unit model: RX)**
No change to jumper setting is required.
 - **For cooling only (outdoor unit model: RK)**
Cut the address jumper (J8) inside the remote controller.

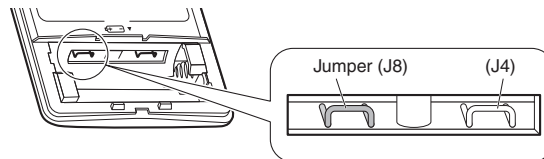

Indoor Unit Installation Diagram

⚠ CAUTION

- Do not hit or violently push the INTELLIGENT EYE sensor. This can lead to damage and malfunction.
- Do not place large objects near the INTELLIGENT EYE sensor. Also keep heating units or humidifiers outside the sensor's detection area.

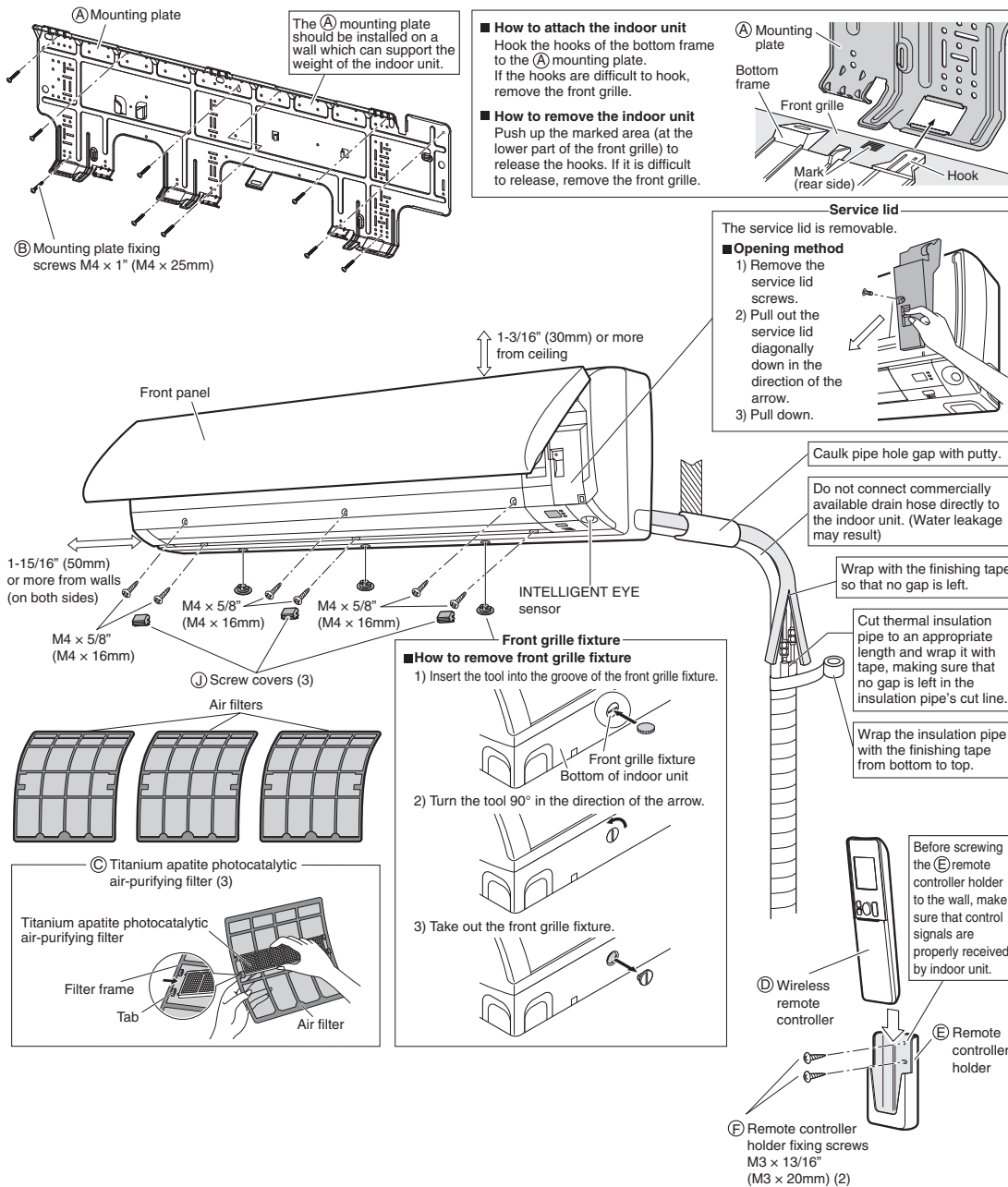

Indoor Unit Installation

1. Installing the mounting plate

The mounting plate should be installed on a wall which can support the weight of the indoor unit.

- 1) Temporarily secure the mounting plate to the wall, make sure that the plate is completely level, and mark the drilling points on the wall.
- 2) Secure the mounting plate to the wall with screws.

Recommended mounting plate retention spots and dimensions

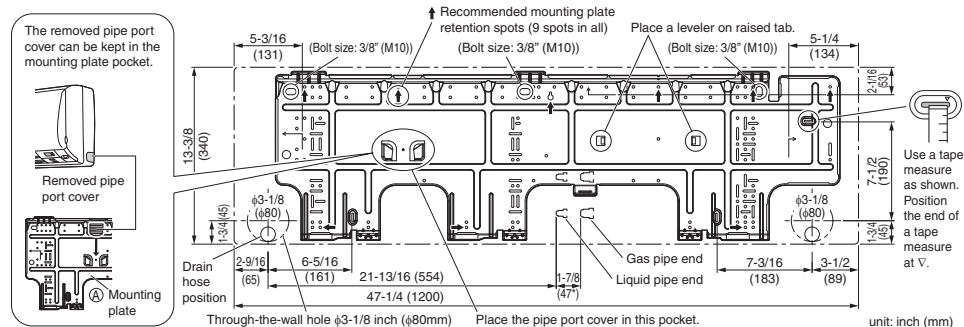

* Depending on the model, the actual distance between the liquid pipe end and gas pipe end may differ from the distance between those symbols on the mounting plate (the distance listed in this manual). Always measure the actual distance between the liquid pipe end and gas pipe end before installing refrigerant pipes.

2. Drilling a wall hole and installing wall embedded pipe

⚠ WARNING

For metal frame or metal board walls, be sure to use a wall embedded pipe and wall hole cover in the feed-through hole to prevent possible heat, electric shock, or fire.

- Be sure to caulk the gaps around the pipes with caulking material to prevent condensation.
 - 1) Drill a feed-through hole with a $\phi 3\text{-}1/8$ inch (80mm) diameter through the wall at a downward angle toward the outside.
 - 2) Insert a wall embedded pipe into the hole.
 - 3) Insert a wall hole cover into wall pipe.
 - 4) After completing refrigerant piping, wiring, and drain piping, caulk the pipe hole gap with putty.

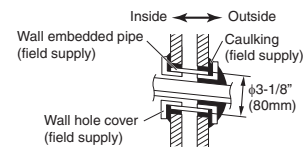

Even if a wall hole cover is not used, caulk both the outdoor and indoor sides with putty.

3. Installing the indoor unit

In the case of bending or curing refrigerant pipes, keep the following precautions in mind. Abnormal sound may be generated if improper work is conducted.

- Do not strongly press the refrigerant pipes onto the bottom frame.
- Do not strongly press the refrigerant pipes on the front grille, either.

3-1. Right-side, right-back, or right-bottom piping

- 1) Attach the drain hose to the underside of the refrigerant pipes with adhesive vinyl tape.
- 2) Wrap the refrigerant pipes and drain hose together with an insulation tape.
- 3) Pass the drain hose and refrigerant pipes through the wall hole, then position the indoor unit on the (A) mounting plate hooks, using the Δ markings at the top of the indoor unit as a guide.
- 4) Open the front panel, then open the service lid. (Refer to "Service lid" on page 4.)
- 5) Pass the inter-unit wire from the outdoor unit through the feed-through wall hole and then through the back of the indoor unit. Pull them through the front side. Bend the ends of tie wires upward for easier work in advance. (If the inter-unit wire ends are to be stripped first, bundle wire ends with adhesive tape.)
- 6) Press the bottom frame of the indoor unit with both hands until it is firmly caught by the (A) mounting plate hooks. Make sure that the wires do not catch on the edge of the indoor unit.

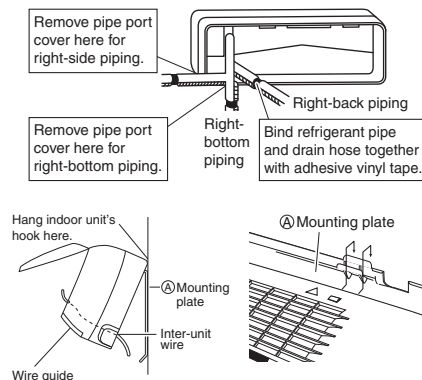

3-2. Left-side, left-back, or left-bottom piping

How to switch around the drain plug and drain hose

1) Remove the fixing screw and pull out the drain hose.

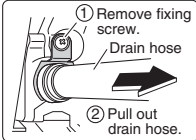

① Remove fixing screw.
Drain hose

② Pull out drain hose.

3) Switch around the drain hose and drain plug.

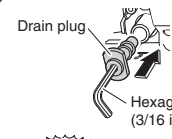

Drain plug

Hexagonal wrench (3/16 inch (4mm))

Push the drain plug all the way in using a hexagonal wrench (3/16 inch (4mm)).

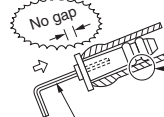

No gap

Do not apply lubricating oil (refrigerant oil) to the drain plug when inserting it. The application of lubrication oil to the drain plug will deteriorate the plug to cause drain leakage from the plug.

Insert a hexagonal wrench (3/16 inch (4mm)).

Insert drain hose securely and fix in place with fixing screw.

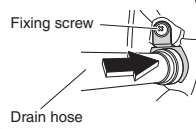

Fixing screw

Drain hose

- 1) Switch around the drain plug and drain hose.
- 2) Attach the drain hose to the underside of the refrigerant pipes with adhesive vinyl tape.
- 3) Shape the refrigerant pipes along the pipe path marking on the (A) mounting plate.
- 4) Pass the drain hose and refrigerant pipes through the wall hole, then position the indoor unit on the (A) mounting plate hooks, using the Δ markings at the top of the indoor unit as a guide.
- 5) Open the front panel, then open the service lid. (Refer to "Service lid" on page 4.)
- 6) Pass the inter-unit wire from the outdoor unit through the feed-through wall hole and then through the back of the indoor unit. Pull them through the front side. Bend the ends of tie wires upward for easier work in advance. (If the inter-unit wire ends are to be stripped first, bundle wire ends with adhesive tape.)
- 7) Connect the refrigerant pipes.
- 8) In case of pulling the drain hose through the back of the indoor unit, wrap the refrigerant pipes and drain hose together with insulation tape as shown in the figure.
- 9) Press the bottom frame of the indoor unit with both hands until it is firmly caught by the (A) mounting plate hooks. Make sure that the wires do not catch on the edge of the indoor unit.

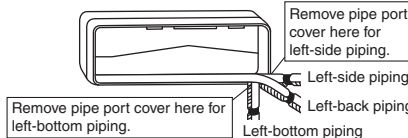

Remove pipe port cover here for left-side piping.

Left-side piping

Left-back piping

Remove pipe port cover here for left-bottom piping.

Left-bottom piping

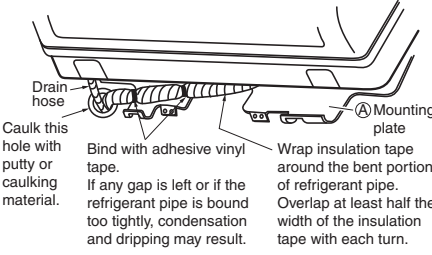

Drain hose

Caulk this hole with putty or caulking material.

Bind with adhesive vinyl tape. If any gap is left or if the refrigerant pipe is bound too tightly, condensation and dripping may result.

Wrap insulation tape around the bent portion of refrigerant pipe. Overlap at least half the width of the insulation tape with each turn.

(A) Mounting plate

Refrigerant pipes

Secure the indoor unit to the (A) mounting plate with the (B) indoor unit fixing screws M4 x 1/2" (M4 x 12mm)(3 points).

Bottom frame

Drain hose (Be sure the drain hose is lower)

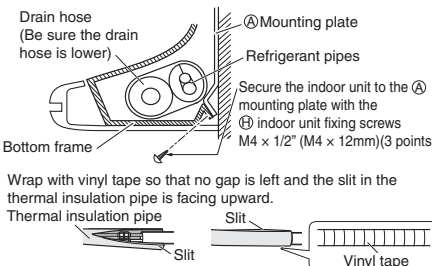

Wrap with vinyl tape so that no gap is left and the slit in the thermal insulation pipe is facing upward.

Thermal insulation pipe

Slit

Slit

Vinyl tape

3-3. Wall embedded piping

Follow the instructions given under

Left-side, left-back, or left-bottom piping

- 1) Insert the drain hose to this depth so it won't be pulled out of the drain pipe.

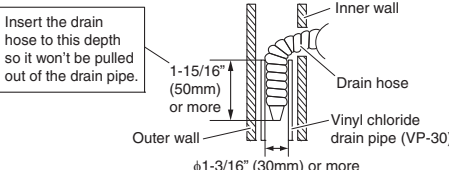

Insert the drain hose to this depth so it won't be pulled out of the drain pipe.

1-15/16" (50mm) or more

Inner wall

Drain hose

Vinyl chloride drain pipe (VP-30)

Outer wall

ϕ 1-3/16" (30mm) or more

Indoor Unit Installation

4. Wiring

Refer to the installation manual for the outdoor unit also.



WARNING

- Do not use tapped wires, extension cords, or starburst connections, as they may cause overheating, electric shock, or fire.
- Do not use locally purchased electrical parts inside the product. (Do not branch the power for the drain pump, etc., from the terminal block.) Doing so may cause electric shock or fire.
- Do not connect the power wire to the indoor unit. Doing so may cause electric shock or fire.



CAUTION

Recommend stranded cable for interunit wiring. Local code always supersedes recommendation.

- For stranded wires, make sure to use the round crimp-style terminal for connection to the power supply terminal block. Place the round crimp-style terminals on the wires up to the covered part and secure in place.

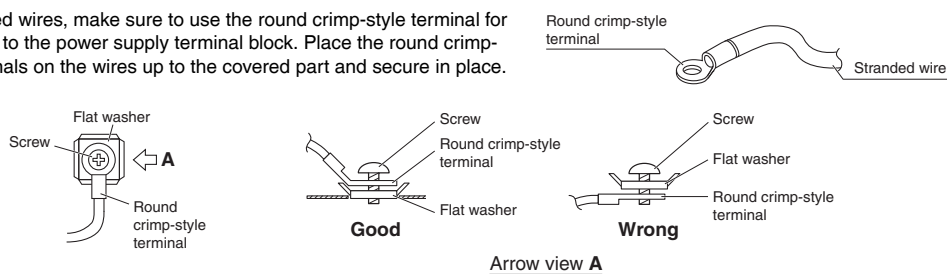

- If solid core wire must be used, be sure to curl the end of the lead. Improper work may cause heat and fire.



- 1) Remove the front grille. (Refer to “2. Removing and installing the front grille” on page 10.)
- 2) Remove the conduit mounting plate and then secure the conduit to the conduit mounting plate with the lock nut, as shown in the illustration.
- 3) Insert the wires including the ground wire into (K) tube.
- 4) Strip wire ends (3/4 inch (20mm)).
- 5) Match wire colors with terminal numbers on the indoor and outdoor unit's terminal blocks and firmly secure the wires in the corresponding terminals with the screws.
- 6) Connect the ground wires to the corresponding terminals.
- 7) Pull the wires lightly to make sure they are securely connected.
- 8) In case of connecting to an adapter system, run the remote controller cable and attach the S21. (Refer to “4. When connecting to an HA system” on page 11.)
- 9) Attach the conduit mounting plate.
- 10) Shape the wires so that the service lid fits securely.
- 11) Attach the front grille. (Refer to “2. Removing and installing the front grille” on page 10.)
- 12) Take care to ensure that all wiring between the indoor unit and the outdoor unit has a consistent connection. Any splices can cause communication errors.

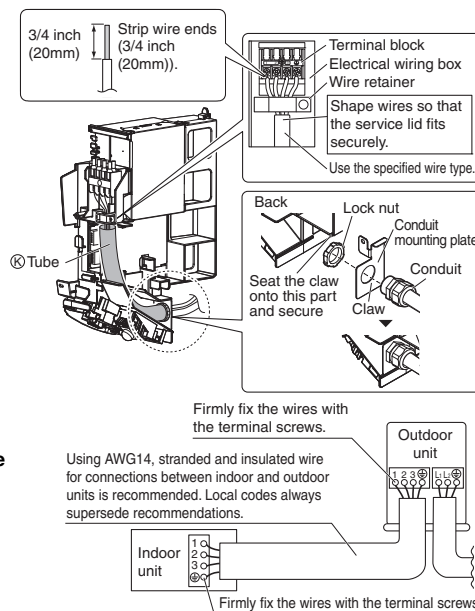

5. Drain piping

- 1) Connect the drain hose, as described on the right.
 - Avoid placing the end of the drain hose in a drainage location that could cause bad odours or corrosive gas to flow backward into the outlet.
 - The drainage water may change color due to bacteria or other organisms. Place in a location where the flow of drainage water will not cause a problem.
 - Minimize the number of bends in the drain hose as much as possible. If bending the drain hose, bend it gently.
- 2) Remove the air filters and transfer some water to the indoor heat exchanger by pouring water into the drain pan.
- 3) Make sure that water flows out of the drain hose.

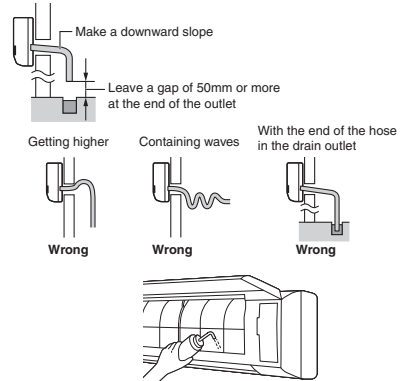

- When drain hose requires extension, obtain an extension hose with an inner diameter of 5/8 inch (16mm). Be sure to thermally insulate the indoor section of the extension hose.
- When connecting a rigid polyvinyl chloride pipe (nominal diameter 1/2 inch (13mm)) directly to the drain hose attached to the indoor unit as with embedded piping work, use any commercially available drain socket (nominal diameter 1/2 inch (13mm)) as a joint.

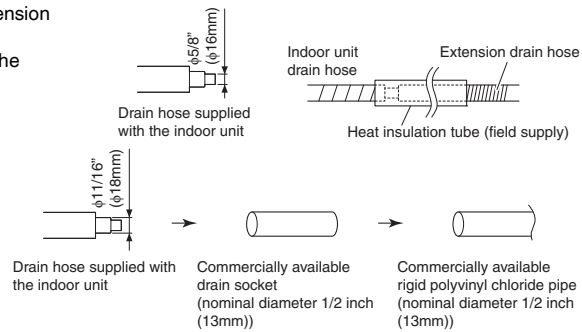

Refrigerant Piping Work

⚠ WARNING

- Do not apply mineral oil on flared part.
- Prevent mineral oil from getting into the system as this would reduce the service life of the units.
- Never use piping which has been used for previous installations. Only use parts which are delivered with the unit.
- Never install a dryer to this R410A unit in order to guarantee its service life.
- The drying material may dissolve and damage the system.
- Incomplete flaring may result in refrigerant gas leakage.

1. Flaring the pipe end

- 1) Cut the pipe end with a pipe cutter.
- 2) Remove burrs with the cut surface facing downward so that the filings do not enter the pipe.
- 3) Put the flare nut on the pipe.
- 4) Flare the pipe.
- 5) Check that the flaring has been done correctly.



Flaring

Set exactly at the position shown below.

Flare tool for R410A	Conventional flare tool	
	Clutch-type	Clutch-type (Rigid-type) Wing-nut-type (Imperial-type)
A	0-0.020 inch (0-0.5mm)	0.039-0.059 inch (1.0-1.5mm) 0.059-0.079 inch (1.5-2.0mm)

Check

The flare's inner surface must be flaw-free.

The pipe end must be evenly flared in a perfect circle.

Make sure that the flare nut is fitted.

2. Refrigerant piping

⚠ CAUTION

- Use the flare nut fixed to the main unit. (This is to prevent the flare nut from cracking as a result of deterioration over time.)
 - To prevent gas leakage, apply refrigeration oil only to the inner surface of the flare. (Use refrigeration oil for R410A.)
 - Use a torque wrench when tightening the flare nuts to prevent damage to the flare nuts and gas leakage.
- Align the centers of both flares and tighten the flare nuts 3 or 4 turns by hand, then tighten them fully with a spanner and a torque wrench.

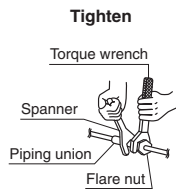
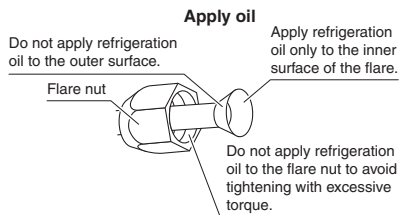

	Piping size	Flare nut tightening torque
Gas side	O.D. 5/8 inch (15.9mm)	45-5/8-55-5/8ft • lbf (61.8-75.4N • m)
Liquid side	O.D. 1/4 inch (6.4mm)	10-1/2-12-3/4ft • lbf (14.2-17.2N • m)

2-1. Caution on piping handling

- Protect the open end of the pipe against dust and moisture.
- All pipe bends should be as gentle as possible. Use a pipe bender for bending.

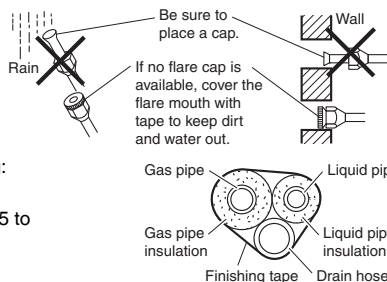

2-2. Selection of copper and heat insulation materials

When using commercial copper pipes and fittings, observe the following:

- Insulation material: Polyethylene foam
Heat transfer rate: 0.041 to 0.052W/mK (0.024 to 0.030Btu/fth°F (0.035 to 0.045kcal/mh°C))
Be sure to use insulation that is designed for use with HVAC Systems.
- ACR Copper only.
- Be sure to insulate both the gas and liquid piping and observe the insulation dimensions as below.

	Piping size	Minimum bend radius	Piping thickness	Thermal insulation size	Thermal insulation thickness
Gas side	O.D. 5/8 inch (15.9mm)	1-15/16 inch (50mm) or more	0.039 inch (1.0mm) (C1220T-O)	I.D. 5/8-13/16 inch (16-20mm)	13/32 inch (10mm) Min.
Liquid side	O.D. 1/4 inch (6.4mm)	1-3/16 inch (30mm) or more	0.031 inch (0.8mm) (C1220T-O)	I.D. 5/16-13/32 inch (8-10mm)	

- Use separate thermal insulation pipes for gas and liquid refrigerant pipes.
- Using finishing tape, bundle and wrap the indoor unit piping and drain hose together so that the drain hose is below the other piping.

Installation Tips

1. Removing and installing the front panel

• Removal method

- 1) Place your fingers in the indentations on the main unit (one each on the left and right sides), and open the front panel until it stops.
- 2) While pushing the left side front panel shaft outward, push up the front panel and remove it. (Remove the right side front panel shaft in the same manner.)
- 3) After removing both front panel shafts, pull the front panel toward yourself and remove it.

• Installation method

Align the tabs of the front panel with the grooves, and push all the way in. Then close slowly. Push the center of the lower surface of the panel firmly to engage the tabs.

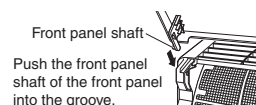
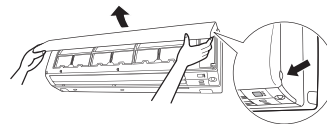

2. Removing and installing the front grille

• Removal method

- 1) Remove the front panel and air filters.
- 2) Remove screw covers (3 pcs.). (See Fig.1)
- 3) Remove the front grille fixing screws (6 screws). (See Fig.1)
- 4) Remove 3 front grille fixtures from the front grille.
- 5) Remove the service lid screw (1 screw) and remove service lid. (See Fig.2)
- 6) In front of the ○○○ mark on the front grille, there are 3 upper hooks. Lightly pull the front grille toward you with one hand, and push down on the hooks with the fingers of your other hand. (See Fig.3)

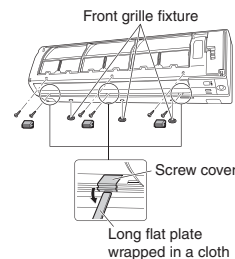

Fig.1

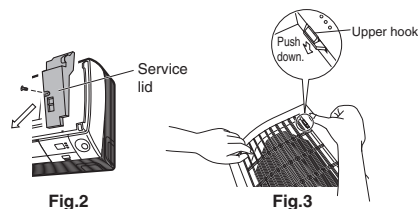

Fig.2

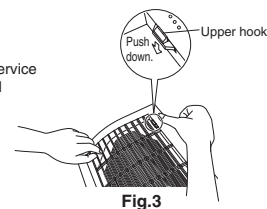

Fig.3

When there is insufficient work space because the unit is close to ceiling

Place both hands under the center of the front grille, and while pushing up, pull it toward you.

• Installation method

- 1) Install the front grille and firmly engage the upper hooks (3 locations).
- 2) Install the 6 screws of the front grille and screw covers (3 pcs.).
- 3) Install 3 front grille fixtures of the front grille.
- 4) Install the service lid and screw for fixing the service lid (1 screw).
- 5) Install the air filters and then mount the front panel.

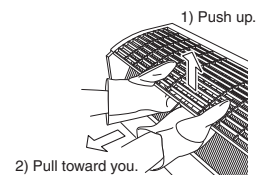

⚠ CAUTION

- Be sure to wear protection gloves.

Installation Tips

3. How to set the different addresses

When 2 indoor units are installed in one room, the 2 wireless remote controllers can be set for different addresses. Change the address setting of one of the 2 units. When cutting the jumper, be careful not to damage any of the surrounding parts.

- 1) Remove the front grille. (6 screws, 3 screw covers, 3 fixtures)
(Refer to “2. Removing and installing the front grille” on page 10.)
- 2) Remove the metal plate electrical wiring box cover. (4 tabs)
(See Fig.1)
- 3) Cut the address jumper (JA) on the printed circuit board.
(See Fig.2)
- 4) Cut the address jumper (J4) in the remote controller. (See Fig.3)
 - Do not cut jumper (J8). (Jumper (J8) is cut to switch over the system to cooling only.)
- 5) Replace the metal electrical wiring box cover.
- 6) Replace the front grille.

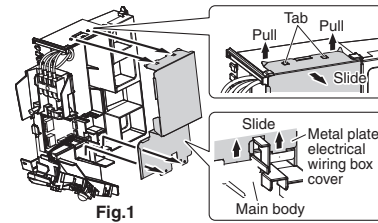

Fig.1

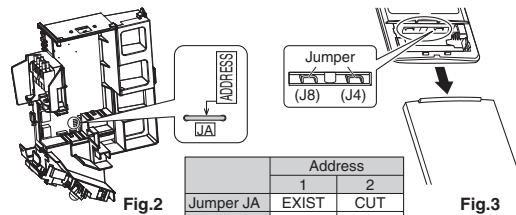

Fig.2

Fig.3

4. When connecting to an HA system

For this procedure, accessories which are sold separately are needed. (wired remote controller, central remote controller, etc.)

- 1) Remove the front grille. (6 screws, 3 screw covers, 3 fixtures)
(Refer to “2. Removing and installing the front grille” on page 10.)
- 2) Remove the metal plate electrical wiring box cover. (4 tabs) (See Fig.1)
- 3) Attach the connection cord to the S21 connector and pull the harness out through the notched part in the figure. (See Fig.4)
- 4) Replace the electrical wiring box cover as it was, and pull the harness around, as shown in the figure. (See Fig.5)
- 5) Replace the front grille.

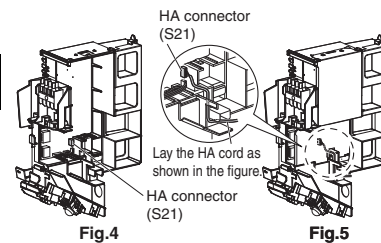







Fig.4

Fig.5

Trial Operation and Testing

1. Trial operation and testing

- Trial operation should be carried out in either COOL or HEAT operation.
- 1-1. Measure the supply voltage and make sure that it is within the specified range.**
- 1-2. In COOL operation, select the lowest programmable temperature; in HEAT operation, select the highest programmable temperature.**
- 1-3. Carry out the trial operation following the instructions in the operation manual to ensure that all functions and parts, such as the movement of the louvers, are working properly.**
 - To protect the air conditioner, restart operation is disabled for 3 minutes after the system has been turned off.
- 1-4. After trial operation is complete, set the temperature to a normal level (78°F to 82°F (26°C to 28°C) in COOL operation, 68°F to 75°F (20°C to 24°C) in HEAT operation).**
- When operating the air conditioner in COOL operation in winter, or HEAT operation in summer, set it to the trial operation mode using the following method.

- 1) Press , , and  at the same time.
- 2) Press , select “T””, and press  for confirmation.
- 3) Press  to turn on the system.



- Trial operation will stop automatically after about 30 minutes. To stop the operation, press .
- Some of the functions cannot be used in the trial operation mode.
- The air conditioner draws a small amount of power in its standby mode. If the system is not to be used for some time after installation, shut off the circuit breaker to eliminate unnecessary power consumption.
- If the circuit breaker trips to shut off the power to the air conditioner, the system will restore the original operation mode when the circuit breaker is opened again.

2. Test items

Test items	Symptom	Check
Indoor and outdoor units are installed securely.	Fall, vibration, noise	
No refrigerant gas leaks.	Incomplete cooling/heating function	
Refrigerant gas and liquid pipes and indoor drain hose extension are thermally insulated.	Water leakage	
Draining line is properly installed.	Water leakage	
System is properly grounded.	Electrical leakage	
Only specified wires are used for all wiring, and all wires are connected correctly.	No operation or burn damage	
Indoor or outdoor unit's air inlet or air outlet are unobstructed.	Incomplete cooling/heating function	
Stop valves are opened.	Incomplete cooling/heating function	
Indoor unit properly receives remote controller commands.	No operation	
Remote controller jumper setting is correct for the type of unit (heat pump or cooling only).	Remote controller malfunctioning	

11.2 Outdoor Unit

Contents

Safety Considerations	1	4. Refrigerant piping	6
Accessories	3	5. Pressure test and evacuating system.....	7
Precautions for Selecting a Location	3	6. Refilling refrigerant	8
Precautions on Installation	4	Wiring	9
Outdoor Unit Installation Diagram	4	Facility Setting	
Installation Space Requirements	5	(cooling at low outdoor temperature)	11
Outdoor Unit Installation	5	When attaching the drain pan heater	12
1. Installing the outdoor unit	5	Pump Down Operation	13
2. Drain work (Only for heat pump models).....	5	Trial Operation and Testing	14
3. Flaring the pipe end.....	6	1. Trial operation and testing	14
		2. Test items	14

The pictures in this document are for illustrative purposes only.

Safety Considerations

Refer also to the General Safety Considerations in the separate booklet.





Read the precautions in this manual carefully before operating the unit.

Read these **Safety Considerations for Installation** carefully before installing an air conditioner or heat pump. After completing the installation, make sure that the unit operates properly during the startup operation.

Instruct the user on how to operate and maintain the unit. Inform users that they should store this installation manual with the operation manual for future reference.

Always use a licensed installer or contractor to install this product. Improper installation can result in water or refrigerant leakage, electric shock, fire, or explosion.

Meanings of **DANGER**, **WARNING**, **CAUTION**, and **NOTE** Symbols:

-  **DANGER**
-  **WARNING**
-  **CAUTION**
-  **NOTE**

 **DANGER** _____

- Refrigerant gas is heavier than air and replaces oxygen. A massive leak can lead to oxygen depletion, especially in basements, and an asphyxiation hazard could occur leading to serious injury or death.
- Do not ground units to water pipes, gas pipes, telephone wires, or lightning rods as incomplete grounding can cause a severe shock hazard resulting in severe injury or death. Additionally, grounding to gas pipes could cause a gas leak and potential explosion causing severe injury or death.

- If refrigerant gas leaks during installation, ventilate the area immediately. Refrigerant gas may produce toxic gas if it comes into contact with fire. Exposure to this gas could cause severe injury or death.
- After completing the installation work, check that the refrigerant gas does not leak throughout the system.
- Do not install unit in an area where flammable materials are present due to risk of explosions that can cause serious injury or death.
- Safely dispose all packing and transportation materials in accordance with federal/state/local laws or ordinances. Packing materials such as nails and other metal or wood parts, including plastic packing materials used for transportation may cause injury or death by suffocation.

 **WARNING** _____

- Only qualified personnel licensed or certified in their jurisdiction must carry out the installation work. Installation must be done in accordance with this installation manual. Improper installation may result in water leakage, electric shock, or fire.
- When installing the unit in a small room, take measures to keep the refrigerant concentration from exceeding allowable safety limits. Excessive refrigerant leaks, in the event of an accident in a closed ambient space, can lead to oxygen deficiency.
- Use only specified accessories and parts for installation work. Failure to use specified parts may result in water leakage, electric shock, fire, or the unit falling.
- Install the air conditioner or heat pump on a foundation strong enough that it can withstand the weight of the unit. A foundation of insufficient strength may result in the unit falling and causing injury.
- Take into account strong winds, typhoons, or earthquakes when installing. Improper installation may result in the unit falling and causing accidents.
- Make sure that a separate power supply circuit is provided for this unit and that all electrical work is carried out by qualified personnel licensed or certified in their jurisdiction according to local, state, and national regulations. An insufficient power supply capacity or improper electrical construction may lead to electric shock or fire.

- Make sure that all wiring is secured, that specified wires are used, and that no external forces act on the terminal connections or wires. Improper connections or installation may result in fire.
- When wiring, position the wires so that the service lid can be securely fastened. Improper positioning of the service lid may result in electric shock, fire, or the terminals overheating.
- Before touching electrical parts, turn off the unit.
- The circuit must be protected with safety devices in accordance with local and national codes, i.e. a circuit breaker.
- Securely fasten the outdoor unit service lid. If the service lid is not installed properly, dust or water may enter the outdoor unit causing fire or electric shock.
- When installing or relocating the system, keep the refrigerant circuit free from substances other than the specified refrigerant (R410A) such as air. Any presence of air or other foreign substance in the refrigerant circuit can cause an abnormal pressure rise or rupture, which may result in equipment damage and even injury.
- Do not change the setting of the protection devices. If the pressure switch, thermal switch, or other protection device is shorted and operated forcibly, or parts other than those specified by Daikin are used, fire or explosion may occur.
- Do not use means to accelerate the defrosting process (if possible) or to clean, other than those recommended by the manufacturer.
- The appliance must be stored in a room without continuously operating ignition sources (for example: open flames, an operating gas appliance or an operating electric heater).
- Do not pierce or burn.
- Be aware that refrigerants may not contain an odor.
- Comply with national gas regulations.

CAUTION

- Do not touch the switch with wet fingers. Touching a switch with wet fingers can cause electric shock.
- Do not allow children to play on or around the unit to prevent injury.
- Wear adequate personal protective equipment (protective gloves, safety glasses,...) when installing, maintaining or servicing the system.
- The heat exchanger fins are sharp enough to cut. To avoid injury, wear gloves or cover the fins while working around them.
- Do not touch the refrigerant pipes during and immediately after operation as the refrigerant pipes may be hot or cold, depending on the condition of the refrigerant flowing through the refrigerant piping, compressor, and other refrigerant cycle parts. Your hands may suffer burns or frostbite if you touch the refrigerant pipes. To avoid injury, give the pipes time to return to normal temperature or, if you must touch them, be sure to wear proper gloves.
- Install drain piping to ensure proper drainage. Improper drain piping may result in water leakage and property damage.
- Insulate piping to prevent condensation.
- Be careful when transporting the product.
- Do not turn off the power immediately after stopping operation. Always wait for at least 5 minutes before turning off the power. Otherwise, water leakage may occur.
- Do not use a charging cylinder. Using a charging cylinder may cause the refrigerant to deteriorate.
- Refrigerant R410A in the system must be kept clean, dry, and tight.
 - (a) Clean and Dry -- Foreign materials (including mineral oils such as SUNISO oil or moisture) should be prevented from getting into the system.



- (b) Tight -- R410A does not contain any chlorine, does not destroy the ozone layer, and does not reduce the earth's protection against harmful ultraviolet radiation. R410A can contribute to the greenhouse effect if it is released. Therefore take proper measures to check for the tightness of the refrigerant piping installation. Read the chapter *Refrigerant Piping* and follow the procedures.
- Since R410A is a blend, the required additional refrigerant must be charged in its liquid state. If the refrigerant is charged in a state of gas, its composition can change and the system will not work properly.
 - The outdoor unit is for R410A. See the catalog for indoor models that can be connected. Normal operation is not possible when connected to non-compatible indoor units.
 - Remote controller (wireless kit) transmitting distance can be shorter than expected in rooms with electronic fluorescent lamps (inverter or rapid start types). Install the indoor unit far away from fluorescent lamps as much as possible.
 - Indoor units are for indoor installation only. Outdoor units can be installed either outdoors or indoors.
 - Do not install the air conditioner or heat pump in the following locations:
 - (a) Where a mineral oil mist or oil spray or vapor is produced, for example, in a kitchen. Plastic parts may deteriorate and fall off or result in water leakage.
 - (b) Where corrosive gas, such as sulfurous acid gas, is produced. Corroding copper pipes or soldered parts may result in refrigerant leakage.
 - (c) Near machinery emitting electromagnetic waves. Electromagnetic waves may disturb the operation of the control system and cause the unit to malfunction.
 - (d) Where flammable gas may leak, where there is carbon fiber, or ignitable dust suspension in the air, or where volatile flammables such as thinner or gasoline are handled. Operating the unit in such conditions can cause a fire.
 - Take adequate measures to prevent the outdoor unit from being used as a shelter by small animals. Small animals making contact with electrical parts can cause malfunctions, smoke, or fire. Instruct the user to keep the area around the unit clean.
 - Servicing shall be performed only as recommended by the manufacturer and licensed or certified in their jurisdiction.

NOTE

- The outdoor unit should be positioned where the unit and power supply wires (breaker panel to outdoor unit) are at least 10ft (3m) away from any televisions or radios. (The unit may cause interference with the picture or sound.) Depending on the radio waves, a distance of 10ft (3m) may not be sufficient to eliminate the noise.
- Dismantling the unit, treatment of the refrigerant, oil and additional parts must be done in accordance with the relevant local, state, and national regulations.
- Only use tools for R410A, such as a gauge manifold, charge hose, gas leak detector, reverse flow check valve, refrigerant charge base, vacuum gauge, or refrigerant recovery equipment.
- If the conventional refrigerant and refrigerator oil are mixed in R410A, the refrigerant may deteriorate.
- This air conditioner or heat pump is an appliance that should not be accessible to the general public.
- As maximum allowable pressure is 604psi (4.17MPa), the wall thickness of field-installed pipes should be selected in accordance with the relevant local, state, and national regulations.

RN006-U

Accessories

<p>(A) Installation manual</p>	1	<p>(B) Drain socket*</p>  <p>This is at the bottom of the packaging.</p>	1
<p>(C) Drain cap (1)*</p> 	6	<p>(D) Drain cap (2)*</p> 	3
<p>(E) Warranty</p>	1	<p>(F) General safety consideration</p>	1

* Only for Heat pump models

Precautions for Selecting a Location

- 1) Choose a place solid enough to bear the weight and vibration of the unit, where the operating sound will not be amplified.
- 2) Choose a location where the air discharged from the unit or the operating sound will not cause a nuisance to the neighbors of the user.
- 3) Avoid locations, such as near bedrooms, where the operating sound may cause disturbance.
- 4) There must be sufficient space to carry the unit into and out of the site.
- 5) There must be sufficient space for air passage and no obstructions around the air inlet and the air outlet.
- 6) The site must not be prone to flammable gas leaks in the surrounding area.
- 7) In coastal areas or other places with a salty atmosphere or one containing sulfate gas, corrosion may shorten the life of the air conditioner.
- 8) Since water will flow from the drain of the outdoor unit, do not place anything under the unit which must be kept away from moisture.
- 9) A location where flammable gas does not leak. Position at least 6-5/8ft (2m) from propane gas cylinders.

NOTE

Cannot be installed suspended from a ceiling or stacked.

CAUTION

When operating the air conditioner in a low outdoor ambient temperature, be sure to follow the instructions described below.

- To prevent exposure to wind, install the outdoor unit with its suction side facing the wall.
- Never install the outdoor unit at a site where the suction side may be exposed directly to wind.
- To prevent exposure to wind, it is recommended to install a baffle plate on the air discharge side of the outdoor unit.
- In heavy snow areas, select an installation site where the snow will not affect the unit.
- If there is a likelihood of snow accumulating on the outdoor unit, attach a snow protection hood.
- In high humidity areas or heavy snow areas, it is recommended to attach a drain pan heater to prevent ice build-up from the bottom frame.

- Construct a large canopy.
- Construct a pedestal.



Install the unit high enough off the ground to prevent burying in snow.

Precautions on Installation

- Check the strength and level of the installation surface so that the unit does not cause any operating vibrations or noise after installation.
- Fix the unit in place securely using foundation bolts, as in the figure. (Prepare 4 sets of 5/16 inch (M8) or 3/8 inch (M10) foundation bolts, nuts and washers; all sold separately.)
- It is best to screw in the foundation bolts until their ends are 3/4 inch (20mm) from the foundation surface.

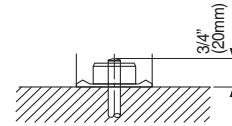

Outdoor Unit Installation Diagram

	RX15/18 RXL15	RXL18	RX24	RX30/36, RK30/36 RXL24
Max. allowable piping length	98-1/2ft (30m)			
Min. allowable piping length	10ft (3m)			
Max. allowable piping height	65-5/8ft (20m)			
Additional refrigerant required for refrigerant pipe exceeding 32-3/4ft (10m) in length.	0.21oz/ft (20g/m)	0.32oz/ft (30g/m)	0.21oz/ft (20g/m)	0.32oz/ft (30g/m)
Gas pipe	O.D. 1/2 inch (12.7mm)		O.D. 5/8 inch (15.9mm)	
Liquid pipe	O.D. 1/4 inch (6.4mm)			

Refrigerant piping must be kept to a minimum.
 *Be sure to add the proper amount of additional refrigerant. Failure to do so may result in reduced performance.
 **The suggested shortest pipe length is 10ft (3m), in order to avoid noise from the outdoor unit and vibration.
 (Mechanical noise and vibration may occur depending on how the unit is installed and the environment in which it is used.)

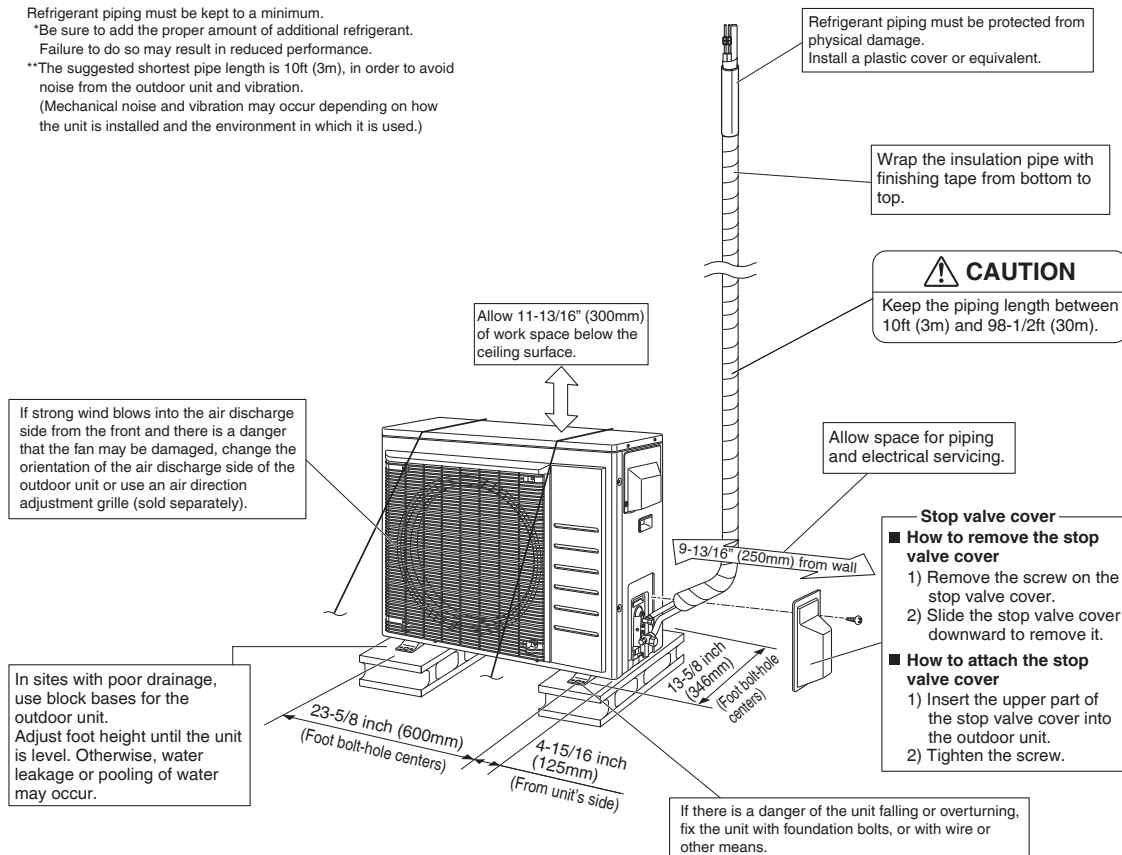

Installation Space Requirements

- Position the unit on a horizontal surface. Any tilt in the unit should be 3° or less to the horizontal.
- Where a wall or other obstacle is in the path of the outdoor unit's intake or exhaust airflow, follow the installation space requirements below.
- For any of the below installation patterns, the wall height on the outlet side should be 47-1/4 inch (1200mm) or less.
- Secure as much installation space around the unit as the location allows, as more space will result in more efficient operation.

Wall facing one side

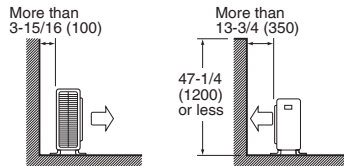

Side view

Walls facing two sides

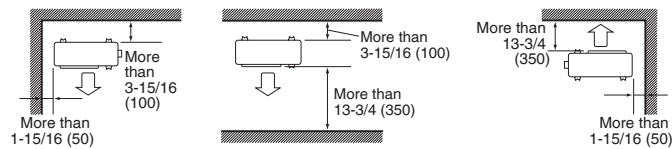

Top view

Walls facing three sides

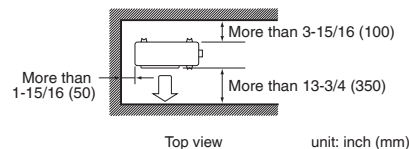

Top view

unit: inch (mm)

When installed as in the figure on the left, it is recommended to either change the orientation of the outdoor unit outlet side or use the air direction adjustment grille (sold separately).

Outdoor Unit Installation

1. Installing the outdoor unit

- When installing the outdoor unit, refer to "Precautions for Selecting a Location" on page 3 and the "Outdoor Unit Installation Diagram" on page 4.
- If drain work is necessary, follow the procedures below.

2. Drain work (Only for heat pump models)

⚠ CAUTION

- In cold areas, do not use a drain socket, drain caps (1,2) and a drain hose with the outdoor unit. (Drain water may freeze, impairing heating performance.)

- If the drain port is covered by a mounting base or floor surface, place additional foot bases of at least 1-1/4 inch (30mm) in height under the outdoor unit's feet.

- 1) Attach ① drain cap (1) and ② drain cap (2).
- 2) Attach ③ drain socket.

- When attaching ③ drain socket to the bottom frame, make sure to connect the drain hose to the drain socket first.

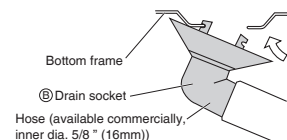
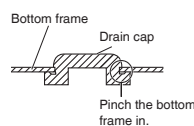
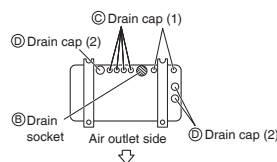

3. Flaring the pipe end

⚠ WARNING

- Do not apply mineral oil to the flare.
- Prevent mineral oil from getting into the system as this would reduce the service life of the units.
- Never use piping which has been used for previous installations. Only use parts which are delivered with this unit.
- Never install a dryer to this R410A unit in order to guarantee its service life.
- The drying material may dissolve and damage the system.
- Incomplete flaring may result in refrigerant gas leakage.

⚠ CAUTION

- Do not reuse joints which have been used once already.

- 1) Cut the pipe end with a pipe cutter.
- 2) Remove burrs with the cut surface facing downward, so that the filings do not enter the pipe.
- 3) Put the flare nut on the pipe.
- 4) Flare the pipe.
- 5) Check that the flaring has been done correctly.

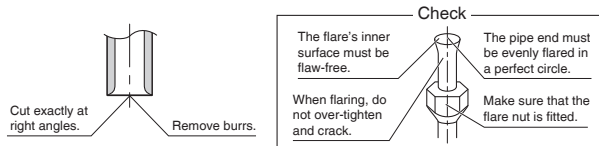

Set exactly at the position shown below.

A	Flare tool for R410A		Conventional flare tool	
	Clutch-type	Clutch-type (Rigid-type)	Wing-nut type (Imperial-type)	
A	0-0.020 inch (0-0.5mm)	0.039-0.059 inch (1.0-1.5mm)	0.059-0.079 inch (1.5-2.0mm)	

4. Refrigerant piping

⚠ CAUTION

- Use the flare nut fixed to the main unit. (This is to prevent the flare nut from cracking as a result of deterioration over time.)
- To prevent gas leakage, apply refrigeration oil only to the inner surface of the flare. (Use refrigeration oil for R410A.)
- Use a torque wrench when tightening the flare nuts to prevent damage to the flare nuts and gas leakage.

- Align the centers of both flares and tighten the flare nuts 3 or 4 turns by hand, then tighten them fully with a spanner and a torque wrench.

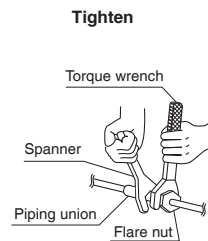
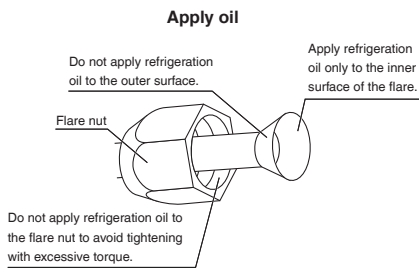

Tightening torque

Piping connection

Flare nut		
Gas side		Liquid side
1/2 inch (12.7mm)	5/8 inch (15.9mm)	1/4 inch (6.4mm)
36-1/2-44-1/2lbf • ft (49.5-60.3N • m)	45-5/8-55-5/8lbf • ft (61.8-75.4N • m)	10-1/2-12-3/4lbf • ft (14.2-17.2N • m)

Valve cap

Width across flats		
11/16 inch (17mm)	1-1/16 inch (27mm)	1-3/16 inch (30mm)
10-1/2-12-5/8lbf • ft (14.2-17.2N • m)	35-3/8-44-1/8lbf • ft (48.0-59.8N • m)	16-5/8-20-1/4lbf • ft (22.5-27.5N • m)

Service port cap

8-10-7/8lbf • ft (10.7-14.7N • m)

Outdoor Unit Installation

Cautions on pipe handling

- Protect the open end of the pipe from dust and moisture.
- All pipe bends should be as gentle as possible. Use a pipe bender for bending.

Selection of copper and heat insulation materials

When using commercial copper pipes and fittings, observe the following:

- Insulation material: Polyethylene foam
Heat transfer rate: 0.041 to 0.052W/mK (0.024 to 0.030Btu/fth°F) (0.035 to 0.045kcal/mh°C)
Be sure to use insulation that is designed for use with HVAC Systems.
- ACR Copper only.
- Be sure to insulate both the gas and liquid piping and observe the insulation dimensions as below.

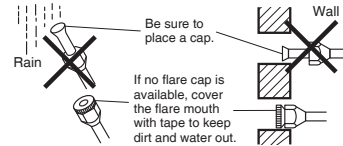

	Piping size	Minimum bend radius	Piping thickness	Thermal insulation size	Thermal insulation thickness
Gas side	O.D. 1/2 inch (12.7mm)	1-9/16 inch (40mm) or more	0.031 inch (0.8mm) (C1220T-O)	I.D. 9/16-5/8 inch (14-16mm)	13/32 inch (10mm) Min.
	O.D. 5/8 inch (15.9mm)	1-15/16 inch (50mm) or more	0.039 inch (1.0mm) (C1220T-O)	I.D. 5/8-13/16 inch (16-20mm)	
Liquid side	O.D. 1/4 inch (6.4mm)	1-3/16 inch (30mm) or more	0.031 inch (0.8mm) (C1220T-O)	I.D. 5/16-13/32 inch (8-10mm)	

- Use separate thermal insulation pipes for gas and liquid refrigerant pipes.
- Using finishing tape, bundle and wrap the indoor unit piping and drain hose together so that the drain hose is below the other piping.

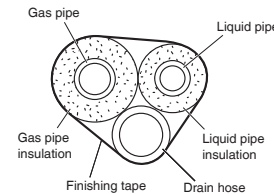

5. Pressure test and evacuating system

⚠ WARNING

- Make sure that air or any matter other than refrigerant (R410A) does not get into the refrigeration cycle.
- If refrigerant gas leaks should occur, ventilate the room as soon and as much as possible.
- R410A, as well as other refrigerants, should always be recovered and never be released directly into the environment.
- Use a vacuum pump for R410A exclusively. Using the same vacuum pump for different refrigerants may damage the vacuum pump or the unit.

⚠ CAUTION

- It is highly recommended that you do not open/close the stop valves when the outdoor temperature is below -5°F (-21°C) as this may result in refrigerant leakage.

- When piping work is complete, it is necessary to perform a pressure test and evacuate system with a vacuum pump.
- If using additional refrigerant, purge the air from the refrigerant pipes and indoor unit using a vacuum pump, then charge additional refrigerant.
- Use a hexagonal wrench (3/16 inch (4mm)) to operate the stop valve rod.
- All refrigerant pipe joints should be tightened with a torque wrench to the specified tightening torque.

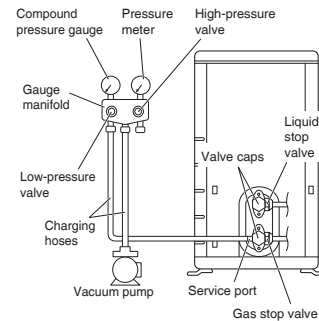

- 1) Pressurize the liquid pipe and gas pipe from the service ports of each stop valve to 604psi (4.17MPa) (do not pressurize more than 604psi (4.17MPa)) for 1 hour minimum, 24 hours recommended. If there is a pressure drop, check for leaks, make repairs and perform the pressure test again.
- 2) Connect the gauge manifold's charging hose to the gas stop valve's service port.
- 3) Fully open the low-pressure valve (Lo) on the gauge manifold and fully close the high-pressure valve (Hi). (High-pressure valve will require no further operation.)
- 4) Evacuate system using vacuum pump to below 500 microns for 1 hour minimum.
- 5) Close the low-pressure valve (Lo) on the gauge manifold and stop vacuum pumping. (Maintain this condition for a few minutes to make sure that the compound pressure gauge pointer does not swing back.)*¹
- 6) Remove the valve caps from the liquid stop valve and gas stop valve.
- 7) To open the liquid stop valve, turn the rod of the valve 90° counter-clockwise using a hexagonal wrench. Close it after 5 seconds, and check for gas leakage. Using soapy water, check for gas leakage from the indoor unit's flare and outdoor unit's flare and valve rods. After the check is complete, wipe all soapy water off.
- 8) Disconnect the charging hoses from the service port for the gas stop valve, then fully open the liquid and gas stop valves. (Do not attempt to turn the valve rods further than they can go.)
- 9) Tighten the valve caps and service port caps for the liquid and gas stop valves with a torque wrench to the specified torques. Refer to "4. Refrigerant piping" on page 6 for details.

*¹ If the compound pressure gauge pointer swings back, the refrigerant may have water content or there may be a loose pipe joint. Check all pipe joints and retighten nuts as needed, then repeat steps 3) through 5).

6. Refilling refrigerant

Check the type of refrigerant to be used on the machine nameplate.

Precautions when adding R410A

Fill from the liquid pipe in liquid form.

R410A is a mixed refrigerant, so adding it in gas form may cause the refrigerant composition to change, preventing normal operation.

- Before filling, check whether the cylinder has a siphon attached or not. (It should have something like "liquid filling siphon attached" displayed on it.)

Filling a cylinder with an attached siphon



Stand the cylinder upright when filling.

(There is a siphon pipe inside, so the cylinder need not be upside-down to fill with liquid.)

Filling other cylinders



Turn the cylinder upside-down when filling.

- Be sure to use the R410A tools to ensure pressure and to prevent foreign objects from entering.

Wiring

⚠ WARNING

- Do not ground units to water pipes, gas pipes, telephone wires, or lightning rods as incomplete grounding can cause a severe shock hazard resulting in severe injury or death. Additionally, grounding to gas pipes could cause a gas leak and potential explosion causing severe injury or death.
- Do not use tapped wires, extension cords, or starburst connections, as they may cause overheating, electric shock, or fire.
- Do not use locally purchased electrical parts inside the product. (Do not branch the power for the drain pump, etc., from the terminal block.) Doing so may cause electric shock or fire.
- The circuit must be protected with safety devices in accordance with local and national codes, i.e. a circuit breaker.
- Use an all-pole disconnection type circuit breaker with at least 1/8 inch (3mm) between the contact point gaps.
- When carrying out wiring, take care not to pull at the conduit.
- Do not connect the power wire to the indoor unit. Doing so may cause electric shock or fire.
- Do not turn on the circuit breaker until all work is completed.

⚠ CAUTION

Precautions to be taken for power supply wiring

Recommend stranded cable for interunit wiring. Local code always supersedes recommendation.

- For stranded wires, make sure to use the round crimp-style terminal for connection to the power supply terminal block. Place the round crimp-style terminals on the wires up to the covered part and secure in place.

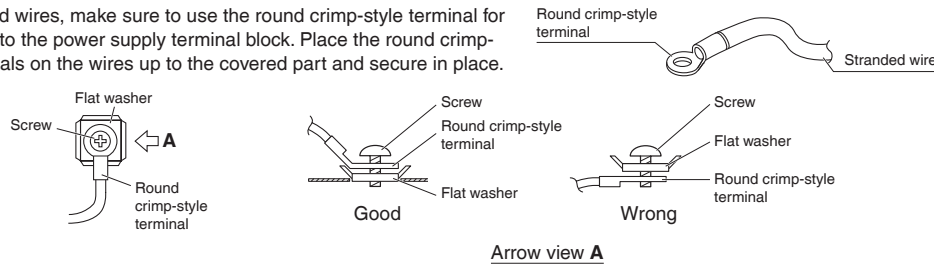

- If solid core wire must be used, be sure to curl the end of the lead. Improper work may cause heat and fire.

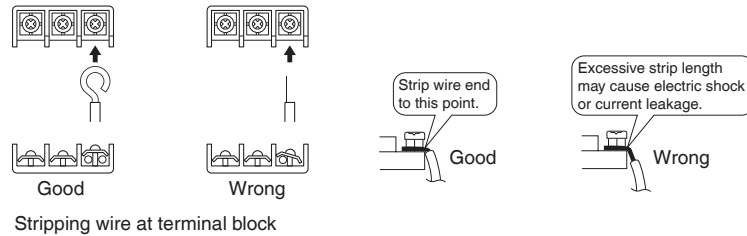

Stripping wire at terminal block

- 1) Strip the insulation from the wire (3/4 inch (20mm)).
- 2) Connect the inter-unit wires between the indoor and outdoor units so that the terminal numbers match. Tighten the terminal screws securely. It is recommended that a slot-head screwdriver be used to tighten the screws.

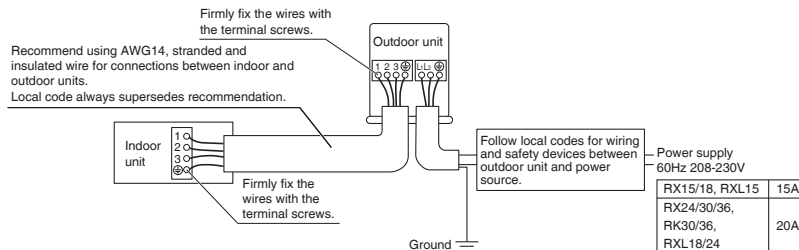

NOTE

Take care to ensure that all wiring between indoor unit and outdoor unit has a consistent connection. Any splices can cause communication errors.

[Method of mounting conduit]

- 1) Dismount the service lid by removing the 2 screws.
- 2) Pass wires through the conduit and secure them with a lock nut.
- 3) After completing the work, reattach the service lid to its original position.

RX15/18/24, RXL15 models

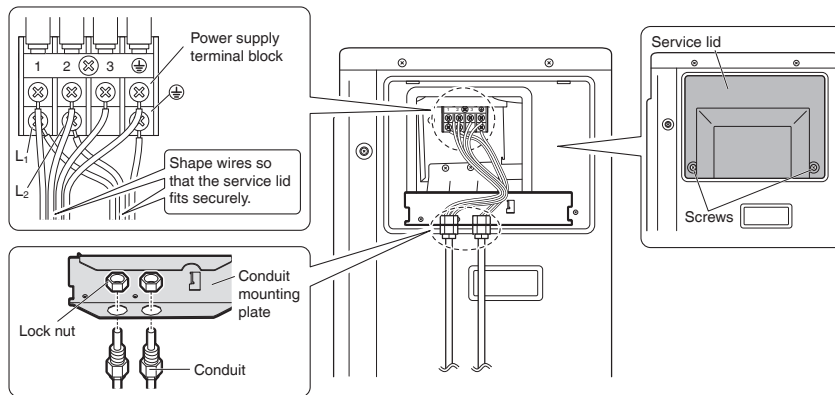

RX30/36, RK30/36, RXL18/24 models

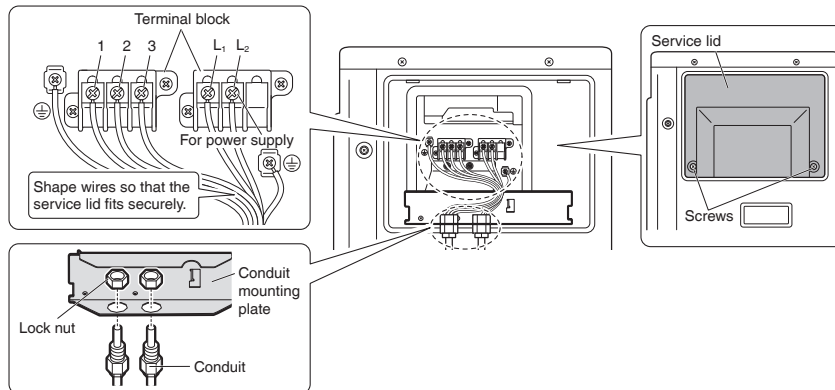

Ground

This air conditioner must be grounded. For grounding, follow all local, and state electrical codes.

Facility Setting (cooling at low outdoor temperature)

⚠ WARNING

- Make sure to turn the power OFF before performing work.

⚠ CAUTION

- If the outdoor unit is installed where the heat exchanger of the unit is exposed to direct wind, provide a windbreak wall.
- Intermittent noises may be produced by the indoor unit due to the outdoor fan turning on and off when using facility settings.
- Do not place humidifiers or other items which might raise the humidity in rooms where facility settings are being used. A humidifier might cause dew condensation from the indoor unit outlet vent.
- Activating the facility setting sets the indoor fan tap to the highest position. Notify the user about this.

This function is designed for facilities such as equipment or computer rooms. It is never to be used in a residence or office where people occupy the space.

RX15/18/24, RXL15 models

■ Cutting jumper 6 (J6) on the PCB will extend the operation range to 14°F (-10°C). Installing an air direction adjustment grille (sold separately) will further extend the operation range to -4°F (-20°C). In these cases, the unit will stop operating if the outdoor temperature falls below -4°F (-20°C), restarting once the temperature rises above this level.

- 1) Remove the top plate of the outdoor unit. (6 screws)
- 2) Remove the front plate. (8 screws)
- 3) Remove the anti-drip cover.
- 4) Cut the jumper (J6) of the PCB inside.

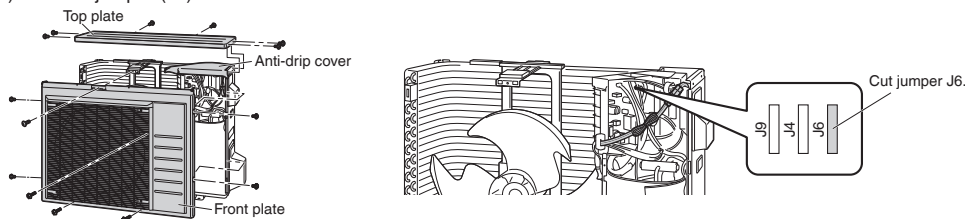

RX30/36, RK30/36, RXL18/24 models

■ Turning on SW5-3 on the PCB will extend the operation range to 14°F (-10°C). Installing an air direction adjustment grille (sold separately) will further extend the operation range to -4°F (-20°C). In these cases, the unit will stop operating if the outdoor temperature falls below -4°F (-20°C), restarting once the temperature rises above this level.

- 1) Remove the service lid. (2 screws)
- 2) Remove the switch cover. (1 screw)
- 3) Turn on SW5-3.

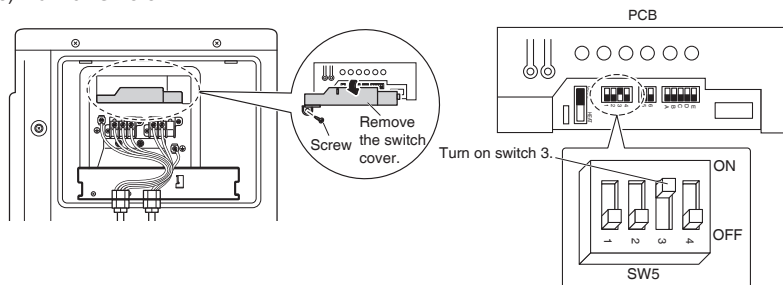

Only for cooling models

■ In addition to turning on SW5-3, turning on SW6-2 as well on the PCB will extend the operation range to -22°F (-30°C). The unit will stop operating if the outdoor temperature falls below -22°F (-30°C), restarting once the temperature rises above this level.

- 1) Turn on SW6-2 in addition to SW5-3.

NOTE

When the outdoor temperature is below -4°F (-20°C) and if SW6-2 in this step is turned on, for the purpose of protecting the compressor, it may take up to 3 hours for operation to begin while the system warms up.

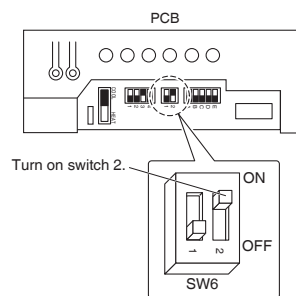

When attaching the drain pan heater

⚠ WARNING

- Make sure to turn the power OFF before performing work.

In high humidity areas or heavy snow areas, it is recommended to attach a drain pan heater to prevent ice build-up from the bottom frame.

RX15/18/24, RXL15 models

- 1) Attach the drain pan heater in accordance with the installation manual included with the drain pan heater.
- 2) Cut the jumper (J9) of the PCB inside.

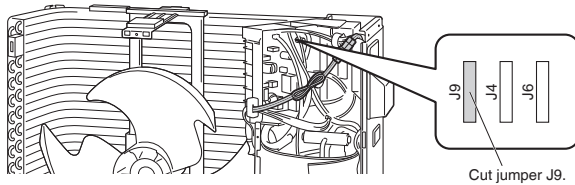

RX30/36, RK30/36, RXL18/24 models

- 1) Attach the drain pan heater in accordance with the installation manual included with the drain pan heater.
- 2) Turn on SW6-1 on the PCB.

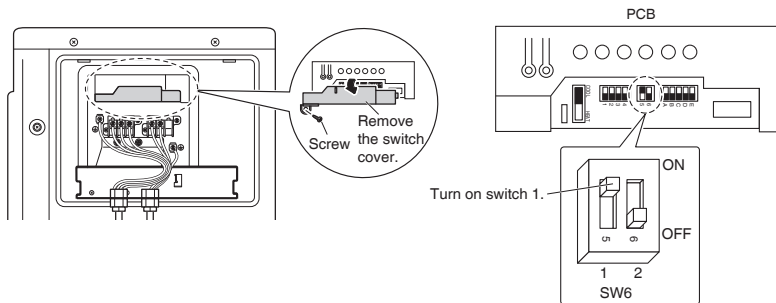

Pump Down Operation

In order to protect the environment, be sure to pump down when relocating or disposing of the unit.

- 1) Remove the valve caps from the liquid stop valve and gas stop valve.
- 2) Begin forced cooling operation.
- 3) After 5 to 10 minutes, close the liquid stop valve with a hexagonal wrench.
- 4) After 2 to 3 minutes, close the gas stop valve and stop forced cooling operation.
- 5) Attach the valve caps once procedures are complete.

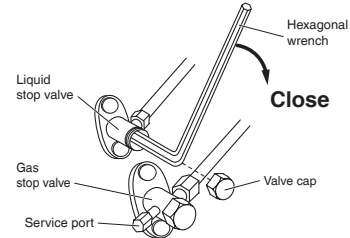

Forced cooling operation

■Using the indoor unit ON/OFF switch

[For FTX, FTXR and FVX models]

Press the indoor unit ON/OFF switch for at least 5 seconds.
(The operation will start.)

- Forced cooling operation will stop automatically after about 15 minutes.
To stop the operation, press the indoor unit ON/OFF switch.





■Using the indoor unit's remote controller

[For FFQ and FDMQ models]

[For wired remote controller]







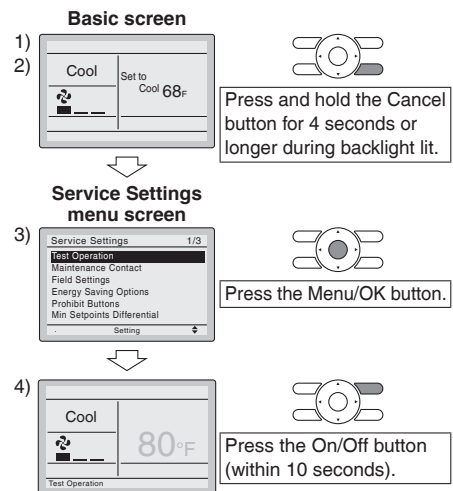

- 1) Set to COOL operation using the remote controller.
- 2) Press and hold the Cancel button for 4 seconds or longer.
Service settings menu is displayed.
- 3) Select **Test Operation** in the service settings menu, and press the Menu/OK button. Basic screen returns and "Test Operation" is displayed at the bottom.
- 4) Press the On/Off button within 10 seconds, and the forced cooling operation starts.
 - Forced cooling operation will stop automatically after about 15 minutes. To stop the operation, press the On/Off button.

[For wireless remote controller]







- 1) Press  and select the COOL operation.
 - 2) Press  twice. "Test" is displayed.
 - 3) Press  within 10 seconds, and the forced cooling operation starts.
- Forced cooling operation will stop automatically after about 15 minutes.
To stop the operation, press .



[For FTX18/24/30/36, FTXR, FVXS models]

- 1) Press ,  and  at the same time.
 - 2) Press , select “ 7 ”, and press  for confirmation.
 - 3) Press  and select the COOL operation.
 - 4) Press  to turn on the system.
- Forced cooling operation will stop automatically after about 30 minutes. To stop the operation, press .

[For FTX15 models]

- 1) Press ,  and  at the same time.
 - 2) Press , then select 7, press .
 - 3) Press  to turn on the system.
- Forced cooling operation will stop automatically after about 30 minutes.
To stop the operation, press .

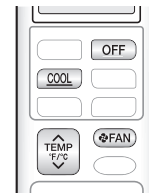

Trial Operation and Testing

- When trial operation is conducted directly after the circuit breaker is turned on, in some cases no air will be output for about 15 minutes in order to protect the air conditioner.

1. Trial operation and testing

Refer to the installation manual for the indoor unit.

2. Test items

Test items	Symptom	Check
Indoor and outdoor units are installed securely.	Fall, vibration, noise	
No refrigerant gas leaks.	Incomplete cooling/heating function	
Refrigerant gas and liquid pipes and indoor drain hose extension are thermally insulated.	Water leakage	
Draining line is properly installed.	Water leakage	
System is properly grounded.	Electrical leakage	
Only specified wires are used for all wiring, and all wires are connected correctly.	No operation or burn damage	
Indoor or outdoor unit's air inlet or air outlet are unobstructed.	Incomplete cooling/heating function	
Stop valves are opened.	Incomplete cooling/heating function	
[For FFQ models] Check that the connector of the lead wires of the decoration panel is connected securely.	Louvers do not move	
Indoor unit properly receives remote control commands.	No operation	

12. Operation Manual

12.1 FTX

Read Before Operation

Safety Considerations

Refer also to the General Safety Considerations in the separate booklet.



Read the precautions in this manual carefully before operating the unit.

Read these **Safety Considerations for Operations** carefully before operating an air conditioner or heat pump.

Make sure that the unit operates properly during the startup operation. Instruct the user on how to operate and maintain the unit.

Inform users that they should store this operation manual with the installation manual for future reference.

Meanings of **DANGER**, **WARNING**, **CAUTION**, and **NOTE** Symbols:

⚠ DANGER Indicates an imminently hazardous situation which, if not avoided, will result in death or serious injury.

⚠ WARNING Indicates a potentially hazardous situation which, if not avoided, could result in death or serious injury.

⚠ CAUTION Indicates a potentially hazardous situation which, if not avoided, may result in minor or moderate injury. It may also be used to alert against unsafe practices.

⚠ NOTE Indicates situations that may result in equipment or property damage accidents only.

— ⚠ DANGER —

- Do not install the unit in an area where flammable materials are present due to risk of explosion resulting in serious injury or death.
- Any abnormalities in the operation of the air conditioner or heat pump, such as smoke or fire, could result in severe injury or death. Turn off the power and contact your dealer immediately.
- Refrigerant gas may produce toxic gas if it comes into contact with fire, such as from a fan heater, stove, or cooking device. Exposure to this gas could cause severe injury or death.
- For refrigerant leakage, consult your dealer. Refrigerant gas is heavier than air and replaces oxygen. A massive leak could lead to oxygen depletion, especially in basements, and an asphyxiation hazard could occur leading to serious injury or death.
- If equipment utilizing a burner is used in the same room as the air conditioner or heat pump, there is the danger of oxygen deficiency which could lead to an asphyxiation hazard resulting in serious injury or death. Be sure to ventilate the room sufficiently to avoid this hazard.
- Safely dispose of the packing materials. Packing materials, such as nails and other metal or wooden parts, may cause stabs or other injuries.
- Tear apart and throw away plastic packaging bags so that children will not play with them. Children playing with plastic bags face the danger of death by suffocation.

— ⚠ WARNING —

- Contact your dealer for repair and maintenance. Improper repair and maintenance may result in water leakage, electric shock, and fire. Only use accessories made by Daikin that are specifically designed for use with the equipment and have them installed by a professional.
- Contact your dealer to move and reinstall the air conditioner or heat pump. Incomplete installation may result in water leakage, electric shock, and fire.
- Never let the indoor unit or the remote controller get wet. Water can cause an electric shock or a fire.
- Never use flammable spray such as hair spray, lacquer, or paint near the unit. Flammable spray may cause a fire.
- When a fuse blows out, never replace it with one of incorrect ampere ratings or different wires. Always replace any blown fuse with a fuse of the same specification.
- Never remove the fan guard of the unit. A fan rotating at high speed without the fan guard is very dangerous.
- Never inspect or service the unit by yourself. Contact a qualified service person to perform this work.
- Turn off all electrical power before doing any maintenance to avoid the risk of serious electric shock; never sprinkle or spill water or liquids on the unit.
- Do not touch the switch with wet fingers. Touching a switch with wet fingers can cause electric shock.
- Do not allow children to play on or around the unit to prevent injury.
- The heat exchanger fins are sharp enough to cut. To avoid injury wear gloves or cover the fins while working around them.
- Do not put a finger or other objects into the air inlet or air outlet. The fan is rotating at high speed and will cause injury.
- Check the unit foundation for damage on a continuous basis, especially if it has been in use for a long time. If left in a damaged condition the unit may fall and cause injury.
- Placing a flower vase or other containers with water or other liquids on the unit could cause a shock or fire if a spill occurs.
- Do not touch the air outlet or horizontal blades while the swing flap is in operation because fingers could get caught and injured.
- Never touch the internal parts of the controller. Do not remove the front panel because some parts inside are dangerous to touch. To check and adjust internal parts, contact your dealer.
- Do not use means to accelerate the defrosting process or to clean, other than those recommended by the manufacturer.
- The appliance must be stored in a room without continuously operating ignition sources (for example: open flames, an operating gas appliance or an operating electric heater).
- Do not pierce or burn.
- Be aware that refrigerants may not contain an odor.

Read Before Operation

⚠ CAUTION

- Do not use the air conditioner or heat pump for any other purposes other than comfort cooling or heating. Do not use the unit for cooling precision instruments, food, plants, animals or works of art.
- Do not place items under the indoor unit as they may be damaged by condensates that may form if the humidity is above 80% or if the drain outlet gets blocked.
- Before cleaning, stop the operation of the unit by turning the power off or by pulling the supply cord out from its receptacle. Otherwise, an electric shock and injury may result.
- Do not wash the air conditioner or heat pump with excessive water. An electric shock or fire may result.
- Avoid placing the controller in a spot which may be splashed with water. Water entering the controller may cause an electric shock or damage the internal electronic parts.
- Do not operate the air conditioner or heat pump when using a room-fumigation type of insecticide. Failure to observe this could cause the chemicals to be deposited in the unit and can endanger the health of those who are hypersensitive to chemicals.
- Do not turn off the power immediately after stopping operation. Always wait for at least 5 minutes before turning off the power. Otherwise, water leakage may occur.
- The appliance is not intended for use by young children or infirm persons without supervision.
- The remote controller should be kept away from children so they cannot play with it.
- Consult with the installation contractor for cleaning.
- Incorrect cleaning of the inside of the air conditioner or heat pump could make the plastics parts break and cause water leakage or electric shock.
- Do not touch the air inlet or aluminum fin of the air conditioner or heat pump as they can cut and cause injury.
- Do not place objects in direct proximity of the outdoor unit. Do not let leaves and other debris accumulate around the unit. Leaves are a hotbed for small animals which can enter the unit. Once inside the unit, animals can cause the unit to malfunction, and cause smoke or fire when they make contact with electrical parts.

⚠ NOTE

- Never press the button of the remote controller with a hard, pointed object. The remote controller may be damaged.
- Never pull or twist the electric wire of the remote controller. It may cause the unit to malfunction.
- Do not place appliances that produce open flames in places that are exposed to the airflow of the unit or under the indoor unit. It may cause incomplete combustion or deformation of the unit due to the heat.
- Do not expose the controller to direct sunlight. The LCD display can become discolored and may fail to display the data.

- Do not wipe the controller operation panel with benzine, thinner, chemical dust cloth, etc. The panel may get discolored or the coating can peel off. If it is heavily dirty, soak a cloth in water-diluted neutral detergent, squeeze it well and wipe the panel clean. Then wipe it with another dry cloth.
- Dismantling of the unit, disposal of the refrigerant, oil, and additional parts, should be done in accordance with the relevant local, state, and national regulations.
- Operate the air conditioner or heat pump in a sufficiently ventilated area and not surrounded by obstacles. Do not use the air conditioner or heat pump in the following places.
 - a. Places with a mist of mineral oil, such as cutting oil.
 - b. Locations such as coastal areas where there is a lot of salt in the air.
 - c. Locations such as hot springs where there is a lot of sulfur in the air.
 - d. Locations such as factories where the power voltage varies a lot.
 - e. In cars, boats, and other vehicles.
 - f. Locations such as kitchens where oil may splatter or where there is steam in the air.
 - g. Locations where equipment produces electromagnetic waves.
 - h. Places with an acid or alkaline mist.
 - i. Places where fallen leaves can accumulate or where weeds can grow.
- Take snow protection measures. Contact your dealer for the details of snow protection measures, such as the use of a snow protection hood.
- Do not attempt to do electrical work or grounding work unless you are licensed to do so. Consult with your dealer for electrical work and grounding work.
- Pay attention to operating sound. Be sure to use the following places:
 - a. Places that can sufficiently withstand the weight of the air conditioner or heat pump yet can suppress the operating sound and vibration.
 - b. Places where warm air from the air outlet of the outdoor unit or the operating sound of the outdoor unit does not annoy neighbors.
- Make sure that there are no obstacles close to the outdoor unit. Obstacles close to the outdoor unit may drop the performance of the outdoor unit or increase the operating sound of the outdoor unit.
- Consult your dealer if the air conditioner or heat pump in operation generates unusual noise.
- Make sure that the drainpipe is installed properly to drain water. If no water is discharged from the drainpipe while the air conditioner or heat pump is in the cooling mode, the drainpipe may be clogged with dust or dirt and water leakage from the indoor unit may occur. Stop operating the air conditioner or heat pump and contact your dealer.
- Do not spray the air conditioner unit with any deodorizers, etc. It may cause the unit to malfunction.

FTP002M-U

Read Before Operation

Names of Parts

Indoor Unit

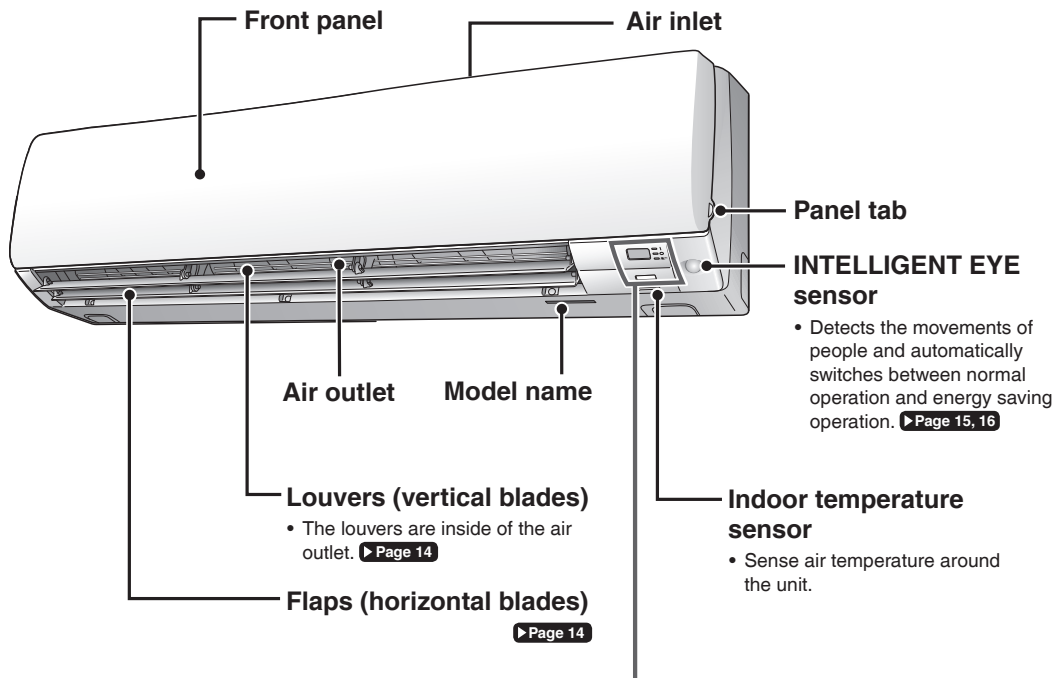

Display

Signal receiver

- Receives signals from the remote controller.
- When the unit receives a signal, you will hear a beep sound.

Case	Sound type
Operation start	beep-beep
Setting changed	beep
Operation stop	long beep

OPERATION lamp (green)

TIMER lamp (orange) ▶ Page 19, 20, 23

INTELLIGENT EYE lamp (green) ▶ Page 15

Indoor unit ON/OFF switch

- Press this switch once to start operation. Press once again to stop it.
- For the operation mode setting, refer to the following table.

Model	Mode	Temperature setting	Airflow rate
HEAT PUMP	AUTO	77°F (25°C)	AUTO
COOLING ONLY	COOL	72°F (22°C)	AUTO

- This switch can be used when the remote controller is missing or out of batteries.

Read Before Operation

■ **Open the front panel**

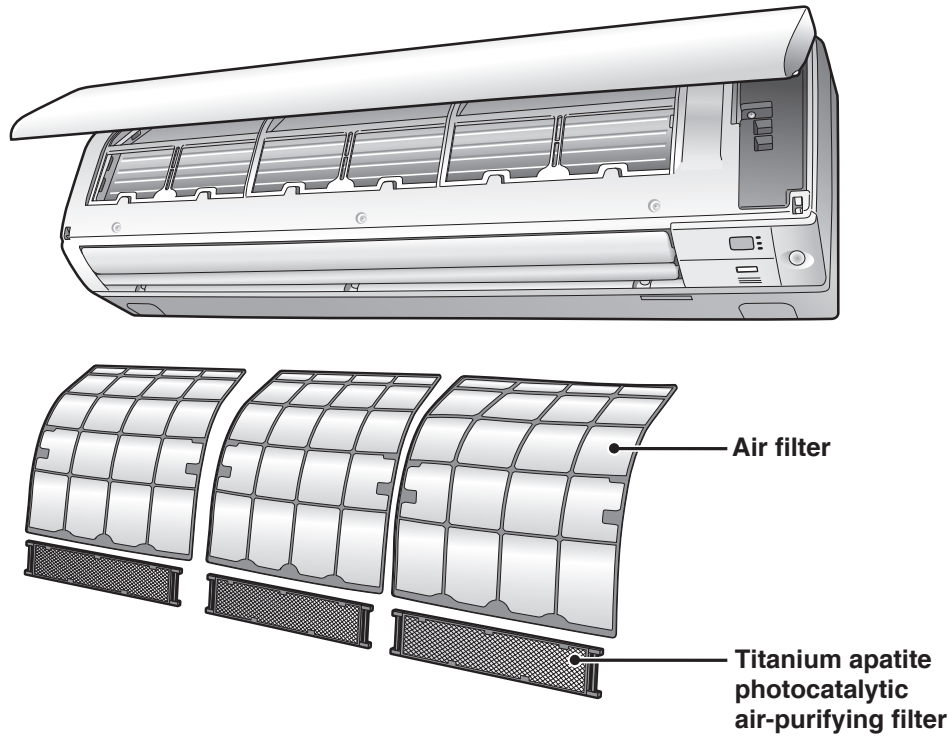

Outdoor Unit

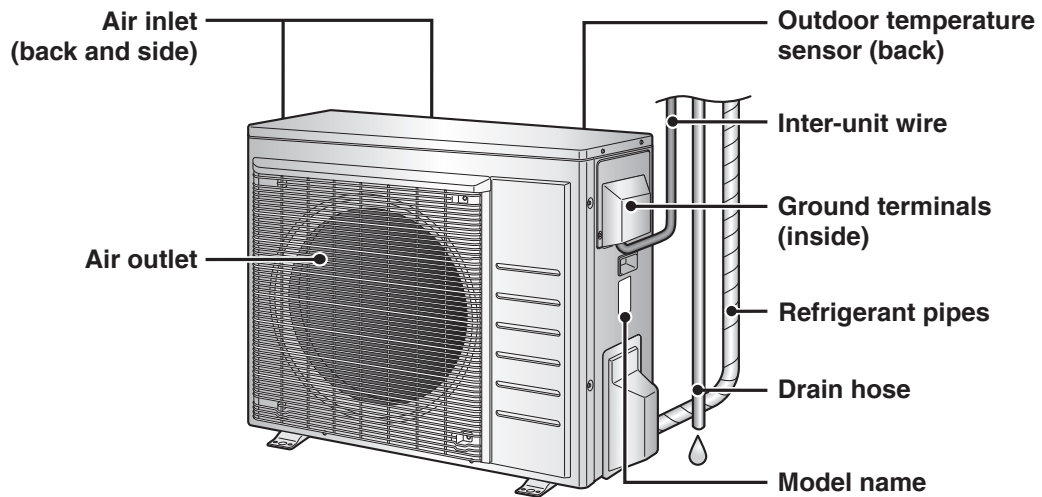

Read Before Operation

Names of Parts

Remote Controller

Signal transmitter

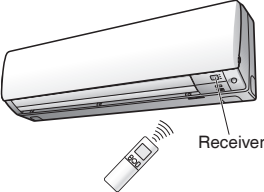

Receiver

- To use the remote controller, aim the transmitter at the indoor unit. If there is anything blocking the signals between the unit and the remote controller, such as a curtain, the unit may not operate.
- The maximum transmission distance is about 23ft (7m).

FAN setting button

- Selects the airflow rate setting. [▶ Page 13](#)

POWERFUL button

- POWERFUL operation. [▶ Page 17](#)

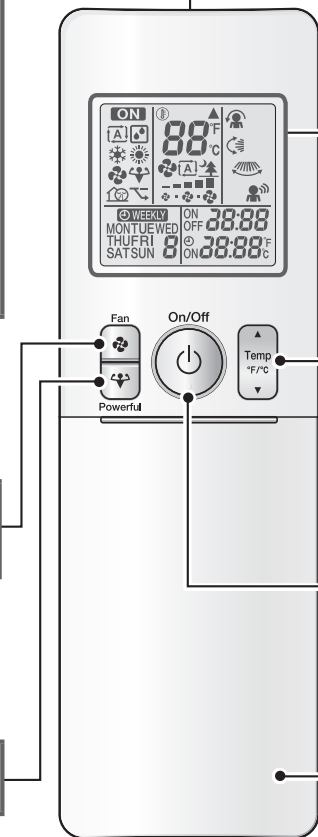

Display (LCD)

- Displays the current settings. (In this illustration, each section is shown with all its displays on for the purpose of explanation.)

TEMPERATURE adjustment button

- Changes the temperature setting. [▶ Page 12](#)

ON/OFF button

- Press this button once to start operation. Press once again to stop it. [▶ Page 11](#)

Front cover

- Open the front cover. [▶ Page 8](#)

Model	ARC466A37
-------	-----------

Read Before Operation

■ **Open the front cover**

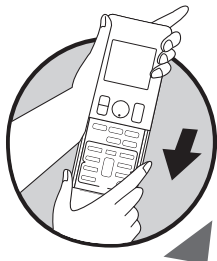

MODE selector button

- Selects the operation mode. (AUTO/DRY/COOL/HEAT/FAN) ▶Page 11

ECONO/QUIET button

- ECONO/QUIET OUTDOOR UNIT operation. ▶Page 18

COMFORT/SENSOR button

- COMFORT AIRFLOW / INTELLIGENT EYE operation. ▶Page 15

SWING button

- Adjusts the airflow direction. ▶Page 14

OFF TIMER button (NIGHT SET mode)

▶Page 20

TIMER CANCEL button

- Cancels the timer setting. ▶Page 19, 20
- Cannot be used for the WEEKLY TIMER operation.

Weekly

◀ : WEEKLY button

⬆ : PROGRAM button

Copy

▶ : COPY button

Back

◀ : BACK button

Next

▶ : NEXT button

- WEEKLY TIMER operation. ▶Page 21

ON TIMER button

▶Page 19

SELECT button

- Changes the clock, ON/OFF TIMER and WEEKLY TIMER settings.

CLOCK button

▶Page 10

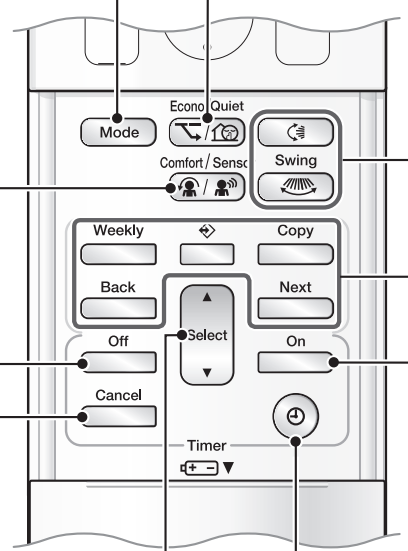

Read Before Operation

Preparation Before Operation

⚠ CAUTION

Incorrect handling of batteries can result in injury from battery leakage, rupturing or heating, or lead to equipment failure. Please observe the following precautions and use safely.

- If the alkaline solution from the batteries should get in the eyes, do not rub the eyes. Instead, immediately flush the eyes with tap water and seek the attention of a medical professional.
- Keep batteries out of reach of children. In the event that batteries are swallowed, seek the immediate attention of a medical professional.
- Do not expose batteries to heat or fire. Do not disassemble or modify batteries. The insulation or gas release vent inside the battery may be damaged, resulting in battery leakage, rupturing, or heating.
- Do not damage or peel off labels on the batteries.

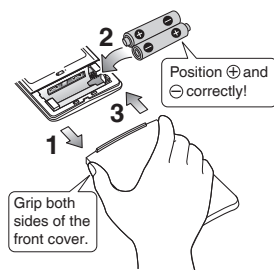

To insert the batteries

1. Slide the front cover to take it off.
2. Insert 2 dry batteries AAA.LR03 (alkaline).
3. Replace the front cover.

To attach the remote controller holder to a wall

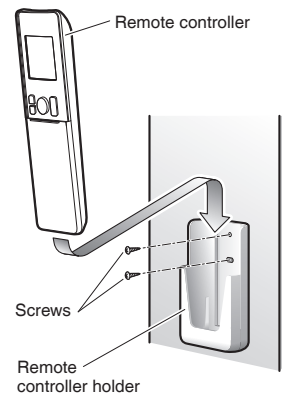

1. Choose a place where the signals reach the unit.
2. Attach the holder to a wall, a pillar, or similar location with the screws supplied with the holder.
3. Place the remote controller in the remote controller holder.

Fahrenheit/Celsius display switch

Press  and  (TIMER button) simultaneously for about 5 seconds.

- The temperature will be displayed in Celsius when it is presently displayed in Fahrenheit, and vice versa.
- The switch operation is only possible when the temperature is being displayed.
- A reception sound will go off for the transmission of set temperature to the indoor unit at the time of setting the Fahrenheit/Celsius display change function.

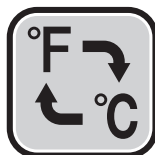

NOTE

Notes on batteries

- To avoid possible injury or damage from battery leakage or rupturing, remove the batteries when not using the product for long periods of time.
- The standard replacement time is about 1 year. Both batteries should be replaced at the same time. Be sure to replace them with new size AAA.LR03 (alkaline) batteries. However, if the remote controller display begins to fade and the possible transmission range becomes shorter within a year, replace both batteries as specified above.
- The batteries supplied with the remote controller are for initial operation. The batteries may run out in less than 1 year.

Notes on remote controller

- Do not drop the remote controller. Do not get it wet.
- If dirt becomes an issue, wipe with a soft dry cloth.

Read Before Operation

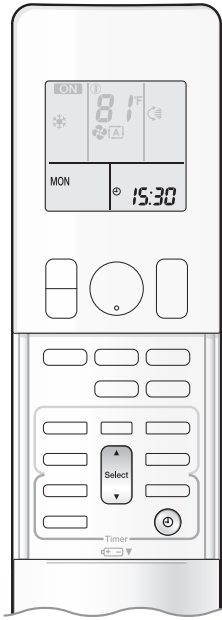

Turn on the circuit breaker

- After the power is turned on, the flaps of the indoor unit open and close once to set the reference position.

To set the clock

1. Press .

“0:00” is displayed on the LCD.
“MON” and “” blink.

2. Press  to set the current day of the week.

Display	Day of the week
MON	Monday
TUE	Tuesday
WED	Wednesday
THU	Thursday
FRI	Friday
SAT	Saturday
SUN	Sunday

3. Press .

“” blinks.

4. Press  to set the clock to the present time.

- Holding down  or  rapidly increases or decreases the displayed time.

5. Press .

- Point the remote controller at the indoor unit when pressing the buttons.



“.” blinks.

NOTE

Fahrenheit/Celsius display change function of remote controller

- The set temperature may increase when the display is changed to Celsius from Fahrenheit, because a fraction of 0.5°C is rounded up.
- Example: A set temperature of 65°F (equivalent to 18.5°C) will be converted into 19°C.
When the display is changed to Fahrenheit again, the set temperature will be converted into 66°F (equivalent to 19°C) instead of the original set temperature (65°F) but a set temperature of 66°F (equivalent to 19°C) will be converted into 19°C with no temperature change.

Note on setting the clock

- If the indoor unit's internal clock is not set to the correct time, the ON/OFF TIMER and WEEKLY TIMER will not operate punctually.

Basic Operation



AUTO · DRY · COOL · HEAT · FAN Operation



The air conditioner operates with the operation mode of your choice. From the next time on, the air conditioner will operate with the same operation mode.

To start operation

1. Press and select an operation mode.

- Each pressing of the button changes the mode setting in sequence.

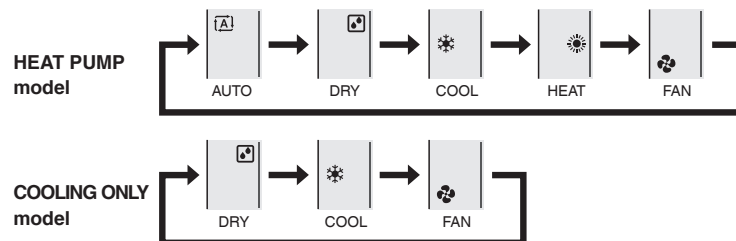

2. Press .

- “**ON**” is displayed on the LCD.
- The OPERATION lamp lights green.

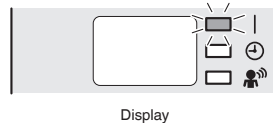

To stop operation

Press again.

- “**ON**” disappears from the LCD.
- The OPERATION lamp goes off.

NOTE

Notes on AUTO operation

- In AUTO operation, the system selects an appropriate operation mode (COOL or HEAT) based on the indoor temperature and starts the operation.
- The system automatically reselects setting at a regular interval to bring the indoor temperature to the user-setting level.

Note on DRY operation

- Eliminates humidity while maintaining the indoor temperature as much as possible. It automatically controls temperature and airflow rate, so manual adjustment of these functions is unavailable.

Basic Operation

To change the temperature setting

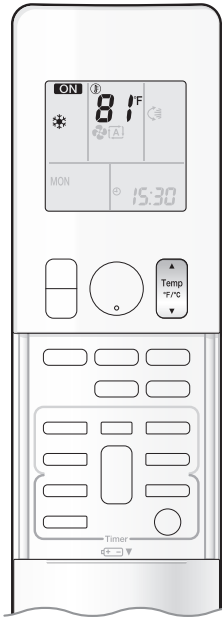

Press  .

- Press ▲ to raise the temperature and press ▼ to lower the temperature.

COOL operation	HEAT operation	AUTO operation	DRY or FAN operation
64-90°F (18-32°C)	50-86°F (10-30°C)	64-86°F (18-30°C)	The temperature setting cannot be changed.

Tips for saving energy

Keeping the temperature setting at a moderate level helps save energy.

- Recommended temperature setting
 - For cooling: 78-82°F (26-28°C)
 - For heating: 68-75°F (20-24°C)

Cover windows with a blind or a curtain.

- Blocking sunlight and air from outdoors increases the cooling (heating) effect.

Keep the air filter clean.

- Clogged air filters cause inefficient operation and waste energy. Clean them once in about every 2 weeks. [▶ Page 29](#)

If you are not going to use the air conditioner for a long period, for example in spring or autumn, turn off the circuit breaker.

- The air conditioner always consumes a small amount of electricity even while it is not operating.



Basic Operation



Adjusting the Airflow Rate

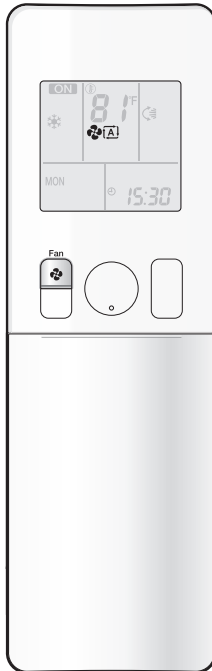

You can adjust the airflow rate to increase your comfort.

To adjust the airflow rate setting

Press .

- Each pressing of changes the airflow rate setting in sequence.

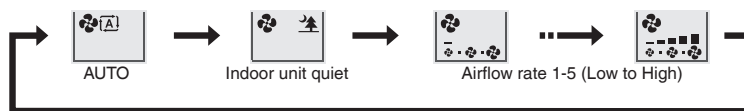

- When the airflow is set to “”, quiet operation starts and noise from the indoor unit will become quieter.
- In the quiet operation mode, the airflow rate is set to a weak level.
- In DRY operation, the airflow rate setting cannot be changed.

NOTE

Note on airflow rate setting

- At smaller airflow rates, the cooling (heating) effect is also smaller.

Note on AUTO airflow rate

- When using AUTO airflow rate, the airflow rate is adjusted according to conditions in the room.



Adjusting the Airflow Direction

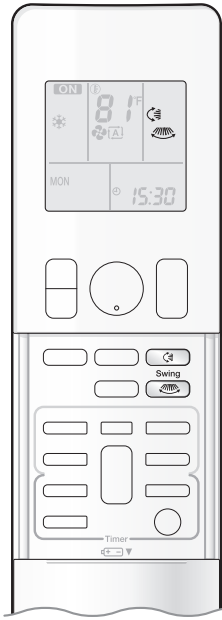

You can adjust the airflow direction to increase your comfort.

CAUTION

- Always use a remote controller to adjust the angles of the flaps and louvers.
 - If you attempt to move the flaps and louvers forcibly by hand when they are swinging, the mechanism may be damaged.
 - Inside the air outlet, a fan is rotating at a high speed.

To start auto swing

Up and down airflow direction

Press .

- “” is displayed on the LCD.
- The flaps (horizontal blades) will begin to swing.

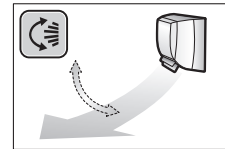

Right and left airflow direction



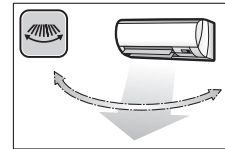

Press .

- “” is displayed on the LCD.
- The louvers (vertical blades) will begin to swing.



The 3-D airflow direction

Press  and .

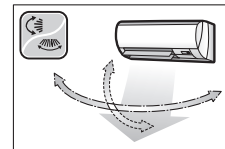

- “” and “” are displayed on the LCD.
- The flaps and louvers move in turn.
- To cancel 3-D airflow, press either  or  again. The flaps or louvers will stop moving.



To set the flaps or louvers at the desired position

- This function is effective while the flaps or louvers are in auto swing mode.

Press  and  when the flaps or louvers reach the desired position.

- In the 3-D airflow, the flaps and louvers move in turn.
- “” or “” disappears from the LCD.

NOTE

Notes on airflow direction setting

- The movable range of the flaps varies according to the operation mode.
- If the airflow rate becomes weak during operation, the flaps and louvers will stop. When up and down airflow direction is set, the flaps will stop in an upward position.
- When the airflow rate setting is low, or when 3-D airflow direction is set, the room temperature may not reach the set temperature (for example, if the air conditioner is blowing air toward the wall). In that case, change the airflow direction or the airflow rate.

Note on 3-D airflow

- Using 3-D airflow circulates cold air, which tends to be collected at the bottom of the room, and hot air, which tends to collect near the ceiling, throughout the room, preventing areas of cold and hot developing.

Movable range of the flaps

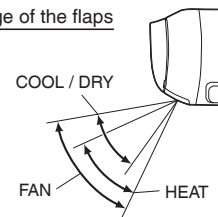

Useful Functions



COMFORT AIRFLOW / INTELLIGENT EYE Operation

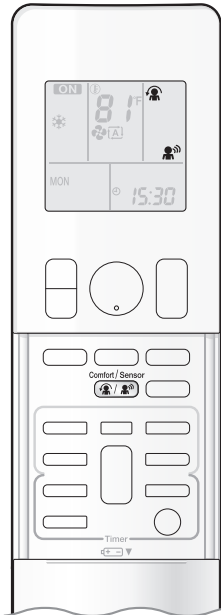

COMFORT AIRFLOW operation:

The flow of air will be in the upward direction while in COOL and DRY operation and in the downward direction while in HEAT operation, which will provide a comfortable airflow that will not come in direct contact with people.

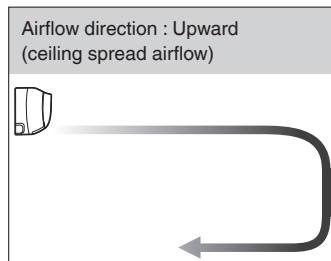

COOL and DRY operation

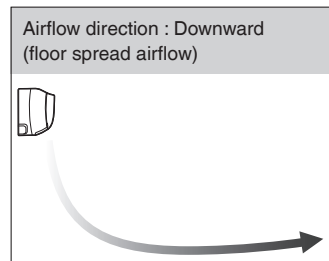

HEAT operation

INTELLIGENT EYE operation: The INTELLIGENT EYE sensor detects human movement. If no one is in the room for more than 20 minutes, the operation automatically changes to energy saving operation.

CAUTION

- Do not place large objects near the INTELLIGENT EYE sensor. Also keep heating units and humidifiers outside the sensor's detection area. This sensor can detect undesirable objects.
- Do not hit or violently push the INTELLIGENT EYE sensor. This can lead to damage and malfunction.

To start operation

Press and select the desired mode.

- Each time is pressed, a different setting option is displayed on the LCD.
- When INTELLIGENT EYE is selected, the INTELLIGENT EYE lamp lights green.



Display

- By selecting “ ” from the following icons, the air conditioner will switch to COMFORT AIRFLOW operation combined with INTELLIGENT EYE operation.



- When the flaps (horizontal blades) are swinging, selecting any of the modes above will cause the flaps (horizontal blades) to stop.

To cancel operation

Press until no icon is displayed.

- If the INTELLIGENT EYE operation was being used, the INTELLIGENT EYE lamp goes off.

Useful Functions

INTELLIGENT EYE operation is useful for energy saving

■ People are detected in the sensing area.

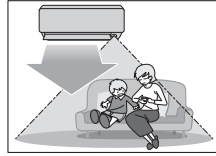

The air conditioner is in normal operation while the sensor is detecting human movement.

■ No people are detected in the sensing area.

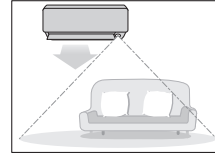

The air conditioner will switch to energy-saving mode after 20 minutes.

Energy saving operation

- If no presence is detected in the room for 20 minutes, the energy saving operation will start, and the INTELLIGENT EYE lamp goes off. If human movement is detected again, the INTELLIGENT EYE lamp lights up and energy saving operation terminates.
- This operation changes the temperature by -3.6°F (-2°C) in HEAT / $+3.6^{\circ}\text{F}$ ($+2^{\circ}\text{C}$) in COOL / $+3.6^{\circ}\text{F}$ ($+2^{\circ}\text{C}$) in DRY operation from the set temperature.
 - When the room temperature exceeds 86°F (30°C), the operation changes the temperature by $+1.8^{\circ}\text{F}$ ($+1^{\circ}\text{C}$) in COOL / $+1.8^{\circ}\text{F}$ ($+1^{\circ}\text{C}$) in DRY operation from the set temperature.
- This operation decreases the airflow rate slightly in FAN operation only.

NOTE**Note on COMFORT AIRFLOW operation**

- The airflow rate will be set to AUTO. If the up and down airflow direction is selected, COMFORT AIRFLOW operation will be canceled.

Notes on INTELLIGENT EYE operation

- Application range is as follows.

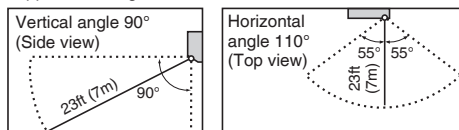

- The sensor may not detect moving objects further than 23ft (7m) away. (Please see the application range)
- Sensor detection sensitivity changes according to the indoor unit location, the speed of passers-by, temperature range, etc.
- The sensor could also mistakenly detect pets, sunlight, fluttering curtains and light reflected off of mirrors as passers-by.
- INTELLIGENT EYE operation will not switch on during POWERFUL operation.
- NIGHT SET mode (▶ Page 20) will not switch on during use of INTELLIGENT EYE operation.

Note on combination of COMFORT AIRFLOW operation and INTELLIGENT EYE operation

- The airflow rate will be set to AUTO. If the up and down airflow direction is selected, COMFORT AIRFLOW operation will be canceled. Priority is given to the function of whichever button is pressed last.

Useful Functions



POWERFUL Operation

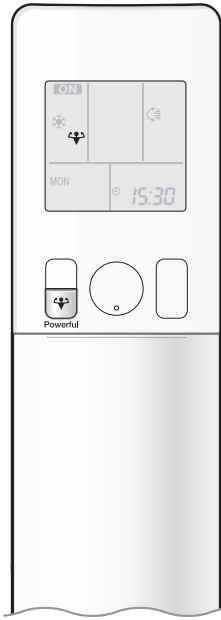

POWERFUL operation quickly maximizes the cooling (heating) effect in any operation mode. In this mode, the air conditioner operates at maximum capacity.

To start POWERFUL operation

Press  during operation.

- “” is displayed on the LCD.
- POWERFUL operation ends in 20 minutes. Then the system automatically operates again with the previous settings which were used before POWERFUL operation.



To cancel POWERFUL operation

Press  again.

- “” disappears from the LCD.

NOTE

Notes on POWERFUL operation

- Pressing  causes the settings to be canceled, and “” disappears from the LCD.
- POWERFUL operation will not increase the capacity of the air conditioner if the air conditioner is already in operation with its maximum capacity demonstrated.

– In COOL, HEAT and AUTO operation

To maximize the cooling (heating) effect, the capacity of outdoor unit increases and the airflow rate becomes fixed at the maximum setting. The temperature and airflow settings cannot be changed.

– In DRY operation

The temperature setting is lowered by 4.5°F (2.5°C) and the airflow rate is slightly increased.

– In FAN operation

The airflow rate is fixed at the maximum setting.

Regarding the combination of POWERFUL and other operations

POWERFUL + COMFORT AIRFLOW	Not available*
POWERFUL + ECONO	
POWERFUL + QUIET OUTDOOR UNIT	

*Priority is given to the function of whichever button is pressed last.

Useful Functions



ECONO / QUIET OUTDOOR UNIT Operation

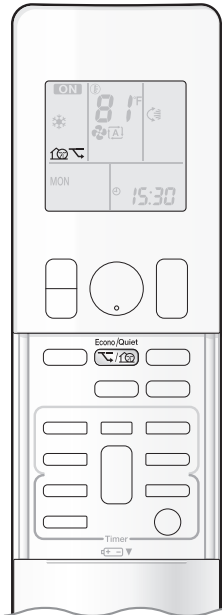

ECONO operation enables efficient operation by limiting the maximum power consumption.

This function is useful to prevent the circuit breaker from tripping when the unit operates alongside other appliances on the same circuit.

QUIET OUTDOOR UNIT operation lowers the noise level of the outdoor unit by changing the frequency and fan speed of the outdoor unit. This function is convenient during the night-time operation.

To start operation

Press  and select the desired mode.

- Each time  is pressed, a different setting option is displayed on the LCD.





To cancel operation

Press  until no icon is displayed.

NOTE

Notes on ECONO operation

- Pressing  causes the settings to be canceled, and “” disappears from the LCD.
- If the power consumption level is already low, switching to ECONO operation will not reduce the power consumption.

Notes on QUIET OUTDOOR UNIT operation

- Even if the operation is stopped by using the remote controller or the indoor unit ON/OFF switch when using QUIET OUTDOOR UNIT operation, “” will remain displayed on the remote controller.
- QUIET OUTDOOR UNIT operation will not reduce the frequency nor fan speed if they already are operating at reduced levels.
- This operation is performed with lower power and therefore may not provide a sufficient cooling (heating) effect.

Possible combinations of ECONO / QUIET OUTDOOR UNIT operation and basic operations

	Operation mode				
	AUTO	DRY	COOL	HEAT	FAN
ECONO	✓	✓	✓	✓	—
QUIET OUTDOOR UNIT	✓	—	✓	✓	—

TIMER Operation



ON/OFF TIMER Operation

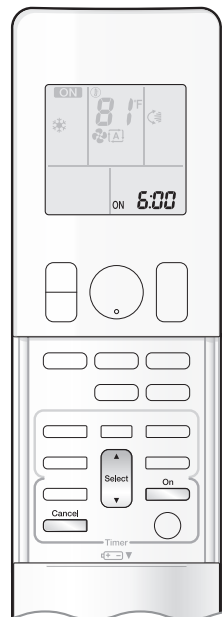

Timer functions are useful for automatically switching the air conditioner on or off in the morning or at night. You can also use the ON TIMER and OFF TIMER together.

To use ON TIMER operation

- Check that the clock is correct.
If not, set the clock to the present time. ▶ [Page 10](#)

1. Press .

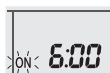

“6:00” is displayed on the LCD.
“ON” blinks.

- “⊕” and day of the week disappear from the LCD.

2. Press until the time setting reaches the point you like.

- Each pressing of either button increases or decreases the time setting by 10 minutes.
Holding down either button changes the setting rapidly.

3. Press again.

- “ON” and setting time are displayed on the LCD.
- The TIMER lamp lights orange. ▶ [Page 5](#)



Display

To cancel ON TIMER operation

Press .

- “ON” and setting time disappear from the LCD.
- “⊕” and day of the week are displayed on the LCD.
- The TIMER lamp goes off.

NOTE

Notes on TIMER operation

- When TIMER is set, the present time is not displayed.
- When using the ON/OFF TIMER to start/stop operation, the actual operation start/stop time may differ from the time set. (Maximum of about 10 minutes)
- The ON/OFF TIMER remembers the time set previously.
- The ON TIMER will begin operation in the settings used previously for operation mode, temperature, airflow rate, and airflow direction.

In the following cases, set the timer again.

- After the circuit breaker has turned off.
- After a power failure.
- After replacing the batteries in the remote controller.

TIMER Operation

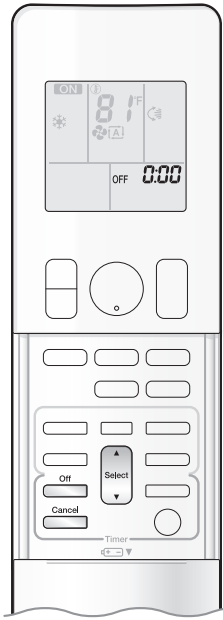

To use OFF TIMER operation

- Check that the clock is correct.
If not, set the clock to the present time. ▶ Page 10

1. Press  .

“ 0:00 ” is displayed on the LCD.
“ OFF ” blinks.

- “ ☉ ” and day of the week disappear from the LCD.

2. Press  until the time setting reaches the point you like.

- Each pressing of either button increases or decreases the time setting by 10 minutes.
Holding down either button changes the time setting rapidly.

3. Press  again.

- “ OFF ” and setting time are displayed on the LCD.
- The TIMER lamp lights orange. ▶ Page 5



Display

To cancel OFF TIMER operation

Press  .

- “ OFF ” and setting time disappear from the LCD.
- “ ☉ ” and day of the week are displayed on the LCD.
- The TIMER lamp goes off.

To combine ON TIMER and OFF TIMER operation

- A sample setting for combining the 2 timers is shown below.

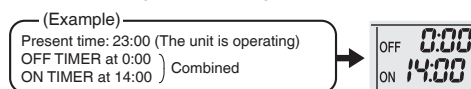

NOTE

NIGHT SET mode

- When the OFF TIMER is set, the air conditioner automatically adjusts the temperature setting (0.9°F (0.5°C) up in COOL, 3.6°F (2.0°C) down in HEAT) to prevent excessive cooling (heating) during sleeping hours.

TIMER Operation



WEEKLY TIMER Operation

Up to 4 timer settings can be saved for each day of the week. This is convenient to adapt the WEEKLY TIMER to your family's lifestyle.

Setting example of the WEEKLY TIMER

The same timer settings are used from Monday through Friday, while different timer settings are used for the weekend.

<p>[Monday]</p>	<p>Make timer settings for programs 1-4. ▶ Page 22</p>
<p>[Tuesday to Friday]</p>	<p>Use the copy mode to make settings for Tuesday to Friday, because these settings are the same as those for Monday. ▶ Page 24</p>
<p>[Saturday]</p>	<p>No timer settings</p>
<p>[Sunday]</p>	<p>Make timer settings for programs 1-4. ▶ Page 22</p>

- Up to 4 reservations per day and 28 reservations per week can be set using the WEEKLY TIMER. The effective use of the copy mode simplifies timer programming.
- The use of ON-ON-ON-ON settings, for example, makes it possible to schedule operating mode and set temperature changes. Furthermore, by using OFF-OFF-OFF-OFF settings, only the turn off time of each day can be set. This will turn off the air conditioner automatically if you forget to turn it off.

TIMER Operation

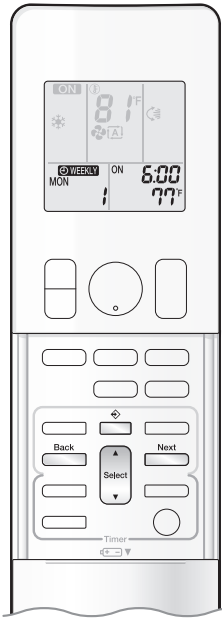

To use WEEKLY TIMER operation

Setting mode

- Make sure the day of the week and time are set.
If not, set the day of the week and time. ▶ **Page 10**

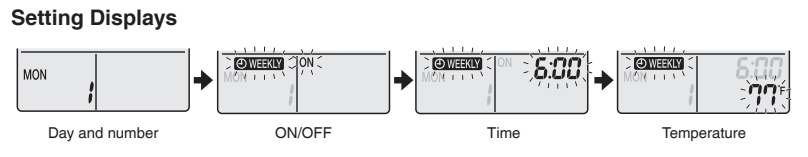
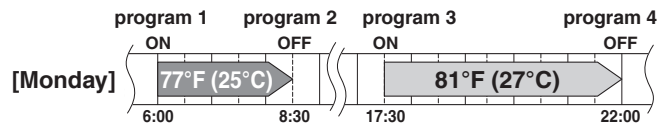

1. Press [Up Arrow].

- The day of the week and the reservation number of the current day will be displayed.
- 1 to 4 settings can be made per day.

2. Press [Select] to select the desired day of the week and reservation number.

- Pressing [Select] changes the reservation number and the day of the week.

3. Press [Next].

- The day of the week and reservation number will be set.
- “WEEKLY” and “ON” blink.

4. Press [Select] to select the desired mode.

- Pressing [Select] changes the “ON” or “OFF” setting in sequence.



- In case the reservation has already been set, selecting “blank” deletes the reservation.
- Proceed to **STEP 9** if “blank” is selected.
- To return to the day of the week and reservation number setting, press [Back].

5. Press [Next].

- The ON/OFF TIMER mode will be set.
- “WEEKLY” and the time blink.

TIMER Operation



WEEKLY TIMER Operation

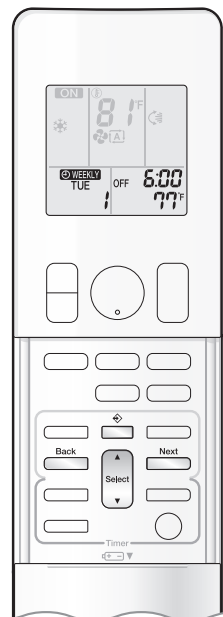



6. Press to select the desired time.

- The time can be set between 0:00 and 23:50 in 10-minute intervals.
- To return to the ON/OFF TIMER mode setting, press .
- Proceed to **STEP 9** when setting the OFF TIMER.

7. Press .

- The time will be set.
- “ WEEKLY ” and the temperature blink.

8. Press to select the desired temperature.

- The temperature can be set between 50°F (10°C) and 90°F (32°C).
COOL or AUTO: The unit operates at 64°F (18°C) even if it is set at 50°F (10°C) to 63°F (17°C).  **Page 12**
- HEAT or AUTO: The unit operates at 86°F (30°C) even if it is set at 87°F (31°C) to 90°F (32°C).  **Page 12**
- To return to the time setting, press .
- The set temperature is only displayed when the mode setting is on.



9. Press .

- Check for a receiving tone and that the OPERATION lamp blinks twice.
- The TIMER lamp lights orange.
- Temperature and time are set in the case of ON TIMER operation, and the time is set in the case of OFF TIMER operation.
- The next reservation screen will appear.
- To continue further settings, repeat the procedure from **STEP 4**.







Display

10. Press to complete the setting.

- “ WEEKLY ” is displayed on the LCD and WEEKLY TIMER operation is activated.
- A reservation made once can be easily copied and the same settings used for another day of the week. Refer to **Copy mode**.  **Page 24**

NOTE

Notes on WEEKLY TIMER operation

- Do not forget to set the clock on the remote controller first.  **Page 10**
- The day of the week, ON/OFF TIMER mode, time and set temperature (only for ON TIMER mode) can be set with the WEEKLY TIMER.
When set to ON TIMER mode, operation will begin in the settings used previously for operation mode, temperature, airflow rate, and airflow direction.
- WEEKLY TIMER and ON/OFF TIMER operation cannot be used at the same time. The ON/OFF TIMER operation has priority if it is set while WEEKLY TIMER is still active. The WEEKLY TIMER will enter the standby state, and “ WEEKLY ” will disappear from the LCD. When the ON/OFF TIMER is up, the WEEKLY TIMER will automatically become active.
- Turning off the circuit breaker, power failure, and other similar events will render operation of the indoor unit's internal clock inaccurate. Reset the clock.  **Page 10**
-  can be used only for the time and temperature settings. It cannot be used to go back to the reservation number.

TIMER Operation

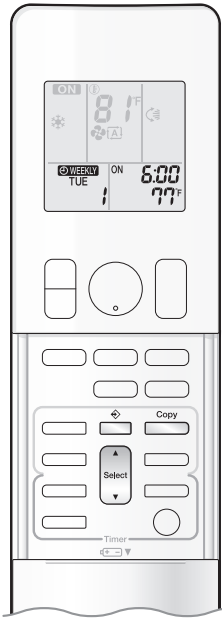

Copy mode

- A reservation made once can be copied to another day of the week. The whole reservation of the selected day of the week will be copied.

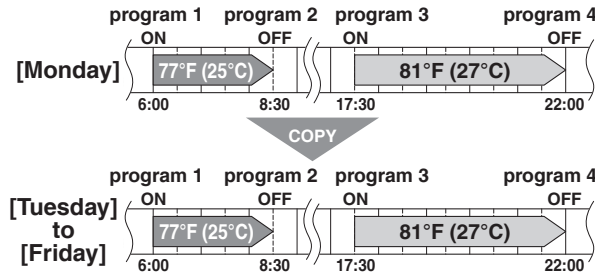

Setting Displays

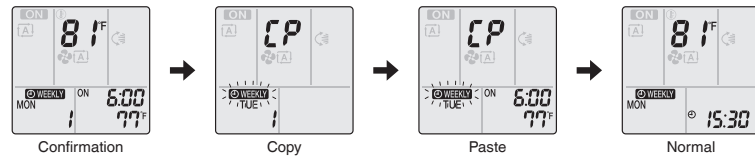

1. Press .
2. Press to confirm the day of the week to be copied.
3. Press .
 - The whole reservation of the selected day of the week will be copied.
4. Press to select the destination day of the week.
5. Press .
 - Check for a receiving tone and that the OPERATION lamp blinks twice.
 - The reservation will be copied to the selected day of the week. The whole reservation of the selected day of the week will be copied.
 - To continue copying the settings to other days of the week, repeat **STEP 4** and **STEP 5**.
6. Press to complete the setting.
 - “ WEEKLY” is displayed on the LCD and WEEKLY TIMER operation is activated.

NOTE

Note on COPY MODE

- The entire reservation of the source day of the week is copied in the copy mode.
 In the case of making a reservation change for any day of the week individually after copying the content of weekly reservations, press and change the settings in the steps of **Setting mode** **Page 22**

TIMER Operation



WEEKLY TIMER Operation

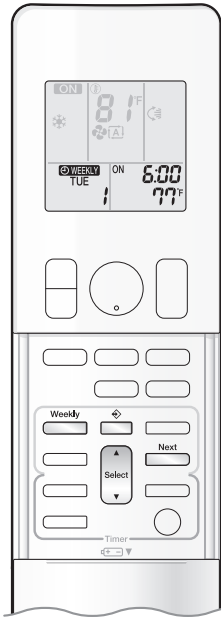

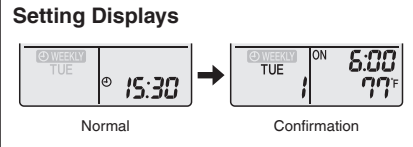

Confirming a reservation

- The reservation can be confirmed.

1. Press  .

- The day of the week and the reservation number of the current day will be displayed.

2. Press  to select the day of the week and the reservation number to be confirmed.

- Pressing  displays the reservation details.
- To change the confirmed reserved settings, select the reservation number and press  . The mode is switched to setting mode. Proceed to **Setting mode STEP 4.** [▶Page 22](#)

3. Press  to exit the confirmation mode.

- “  ” is displayed on the LCD and WEEKLY TIMER operation is activated.

To deactivate WEEKLY TIMER operation

Press  while “  ” is displayed on the LCD.

- “  ” disappears from the LCD.
- The TIMER lamp goes off.
- To reactivate the WEEKLY TIMER operation, press  again.
- If a reservation deactivated with  is activated once again, the last reservation mode will be used.

NOTE

- If not all the reservation settings are reflected, deactivate the WEEKLY TIMER operation once. Then press  again to reactivate the WEEKLY TIMER operation.

TIMER Operation

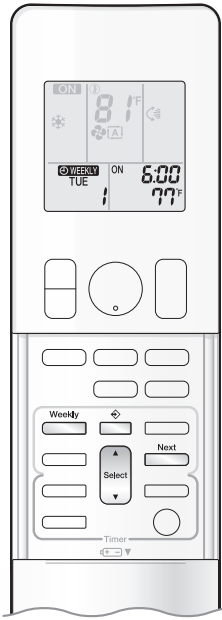

To delete reservations

An individual reservation

1. Press  .

- The day of the week and the reservation number will be displayed.

2. Press  to select the day of the week and the reservation number to be deleted.3. Press  .

- “ WEEKLY” and “ON” or “OFF” blink.

4. Press  until no icon is displayed.

- Pressing  changes the ON/OFF TIMER mode in sequence.
- Selecting “blank” will cancel any reservation you may have.

5. Press  .

- Check for a receiving tone and that the OPERATION lamp blinks twice.
- The selected reservation will be deleted.

6. Press  .

- If there are still other reservations, WEEKLY TIMER operation will be activated.

Reservations for each day of the week

- This function can be used for deleting reservations for each day of the week.
- It can be used while confirming or setting reservations.

1. Press  .

- The day of the week and the reservation number will be displayed.

2. Press  to select the day of the week to be deleted.3. Hold  for about 5 seconds.

- Check for a receiving tone and that the OPERATION lamp blinks twice.
- The reservation of the selected day of the week will be deleted.

4. Press  .

- If there are still other reservations, WEEKLY TIMER operation will be activated.

All reservations

Hold  for about 5 seconds with the normal display.

- Check for a receiving tone and that the OPERATION lamp blinks twice.
- “ WEEKLY” disappears from the LCD.
- The TIMER lamp goes off.
- All reservations will be deleted.
- This operation is not functional while the WEEKLY TIMER setting screen is displayed.

Care

Care and Cleaning

⚠ CAUTION

- Before cleaning, be sure to stop the operation and turn off the circuit breaker.
- Do not touch the aluminum fins of the indoor unit. If you touch those parts, this may cause an injury.

■ Quick reference

Cleaning parts

Front panel

- Wipe with a soft cloth which has been moistened with water or neutral detergent.
- Wipe with a soft dry cloth.

If dirty

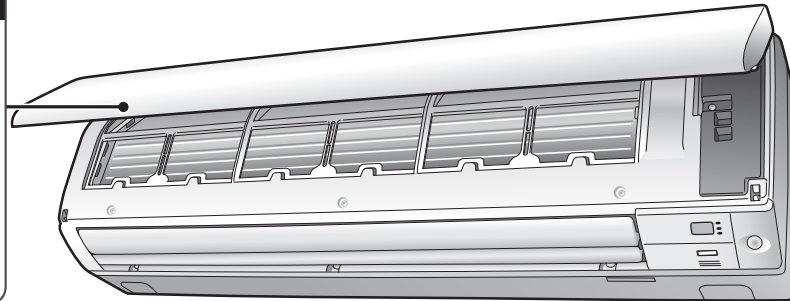
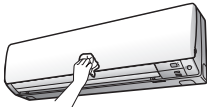

Air filter

- Vacuum dust or wash the filter.

Once every 2 weeks

▶ Page 29

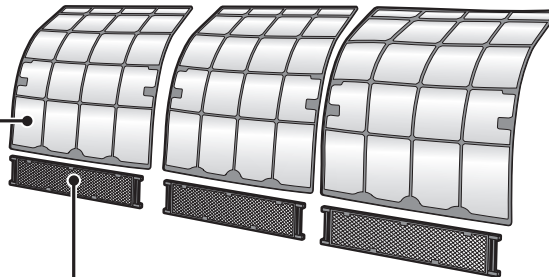

Titanium apatite photocatalytic air-purifying filter

- Vacuum dust or replace the filter.

[Cleaning]

Once every 6 months

▶ Page 30

[Replacement]

Once every 3 years

▶ Page 30

Indoor unit and remote controller

- Wipe them with a soft cloth.

If dirty

Notes on cleaning

For cleaning, do not use any of the following:

- Water hotter than 104°F (40°C)
- Volatile liquid such as benzene, gasoline and thinner
- Polishing compounds
- Rough materials such as a scrubbing brush
- Sprays such as deodorizers



⚠ CAUTION

- When removing or attaching the front panel, stand on a solid, stable base and take care not to fall.
- When removing or attaching the front panel, support the panel securely with your hand to prevent it from falling.

■ Front panel

1. Open the front panel.

- Grip the panel tabs on each side of the front panel and open.

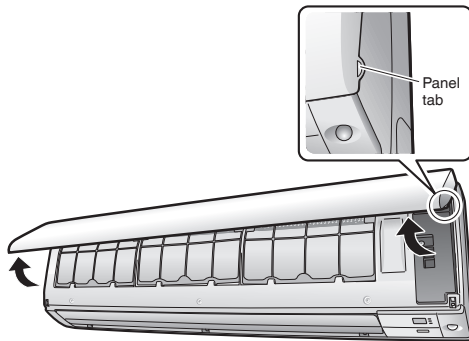

2. Remove the front panel.

- 1) Slide the front panel to either the left or right and pull it toward you to disengage one of the front panel shafts.

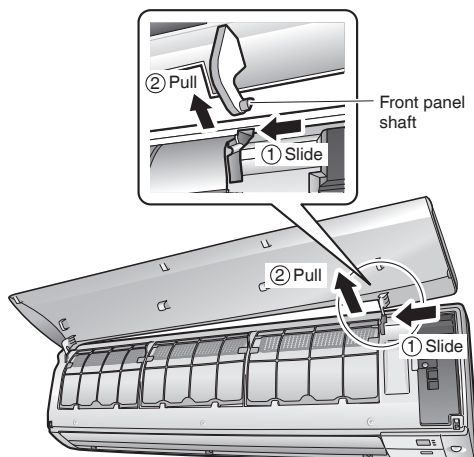

- 2) Disengage the front panel shaft on the other side in the same manner.
- 3) After disengaging both front panel shafts, pull the front panel toward yourself and remove it.

3. Clean the front panel.

- Wipe it with a soft damp cloth.
- Only neutral detergent may be used.
- In case of washing the panel with water, wipe it with a dry soft cloth, and let it dry in the shade after washing.

4. Attach the front panel.

- Align the front panel shaft on the left and right of the front panel with the grooves, then push them all the way in.

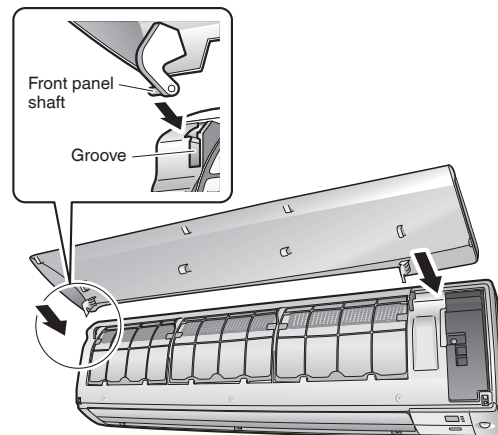

5. Close the front panel slowly.

- Press the front panel at both sides and in the central area.

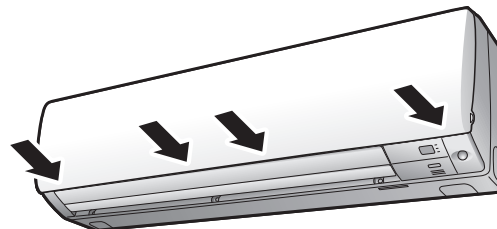

- Make sure that the front panel is securely fixed.

Care

Care and Cleaning

■ Air filter

1. Open the front panel. ▶Page 28

2. Pull out the air filters.

- Push the filter tab at the center of each air filter a little upwards, then pull it down.

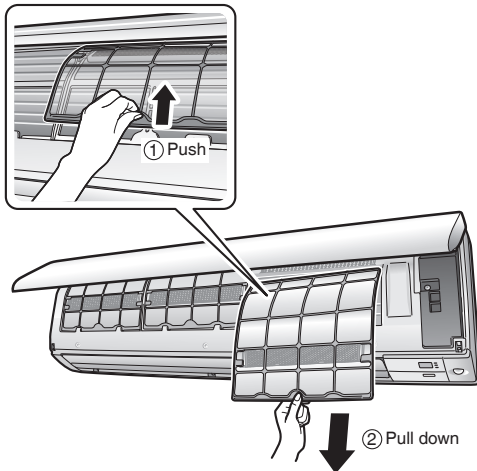

3. Wash the air filters with water or clean them with a vacuum cleaner.

- It is recommended to clean the air filters every 2 weeks.

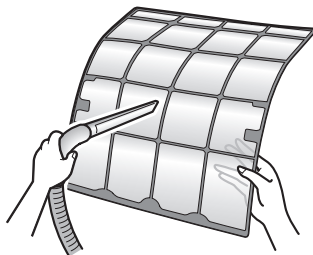

If the dust does not come off easily

- Wash the air filters with neutral detergent thinned with lukewarm water, then let them dry in the shade.
- Be sure to remove the titanium apatite photocatalytic air-purifying filter. Refer to “**Titanium apatite photocatalytic air-purifying filter**” on the next page.



4. Set the filters as they were.

5. Close the front panel slowly.

▶Page 28

■ Titanium apatite photocatalytic air-purifying filter

1. Open the front panel and pull out the air filters. ▶ Page 28, 29

2. Take off the titanium apatite photocatalytic air-purifying filters.

- Hold the recessed parts of the frame and unhook the 4 claws.

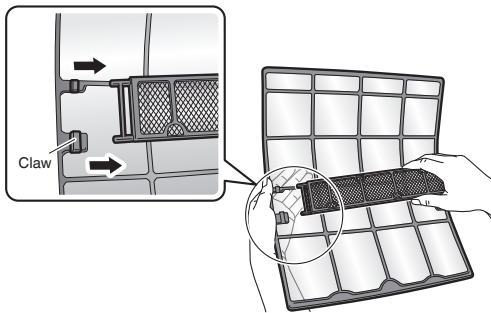

3. Clean or replace the titanium apatite photocatalytic air-purifying filters.

[Cleaning]

3-1 Vacuum dust, and soak in lukewarm water or water for about 10 to 15 minutes if very dirty.

- Do not remove the filter from the frame when washing with water.



3-2 After washing, shake off remaining water and let them dry in the shade.

- Do not wring out the filter to remove water from it.

[Replacement]

Remove the filter from the filter frame and attach a new one.

- Do not throw away the filter frame. Reuse the filter frame when replacing the titanium apatite photocatalytic air-purifying filter.
- When attaching the filter, check that the filter is properly set in the tabs.

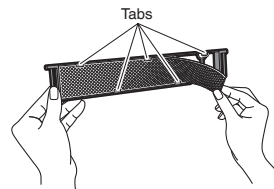

- Dispose of the old filter as non-flammable waste.

4. Set the titanium apatite photocatalytic air-purifying filters as they were.

5. Set the air filters as they were. ▶ Page 29

6. Close the front panel slowly. ▶ Page 28

NOTE

- Operation with dirty filters:
 - cannot deodorize the air,
 - cannot clean the air,
 - results in poor heating or cooling,
 - may cause odor.
- Dispose of old filters as non-flammable waste.
- To order a titanium apatite photocatalytic air-purifying filter, contact the dealer where you bought the air conditioner.



Item	Titanium apatite photocatalytic air-purifying filter (set of 3)
Part No.	KAF970A48 (without frame)

Care

Care and Cleaning

■ Prior to a long period of non-use

1. Operate the FAN mode for several hours to dry out the inside.

- 1) Press  and select "  " .
- 2) Press  and start the operation.

2. After operation stops, turn off the circuit breaker for the room air conditioner.

3. Clean the air filters and reattach them.

4. To prevent battery leakage, take out the batteries from the remote controller.

- When starting to use the air conditioner again, make sure that the drain hose outlet is not blocked, then turn on the circuit breaker.
An operational check of each component will be carried out automatically. (Also, put the batteries into the remote controller.)

■ We recommend periodical maintenance

- In certain operating conditions, the inside of the air conditioner may get foul after several seasons of use, resulting in poor performance. It is recommended to have periodical maintenance by a qualified contractor in addition to regular cleaning by the user.
- For qualified contractor maintenance, please contact the dealer where you bought the air conditioner.

When the Need Arises

FAQ

Indoor unit

The flaps do not start swinging immediately.

- The air conditioner is adjusting the position of the flaps. The flaps will start moving soon.

The air conditioner stops generating airflow during HEAT operation.

- Once the set temperature is reached, the airflow rate is reduced and operation stopped in order to avoid generating a cool airflow. Operation will resume automatically when the indoor temperature falls.

HEAT operation stops suddenly and a flowing sound is heard.

- The outdoor unit is defrosting. HEAT operation starts after the frost on the outdoor unit has been removed. This can take about 4 to 12 minutes.

Operation does not start soon.

- **When the unit is turned on again soon after being turned off.**
- **When the mode was reselected.**
 - This is to protect the air conditioner. You should wait for about 3 minutes.
- **For COOLING ONLY models (outdoor unit: RK models) using facility settings**
 - For the purposes of protecting the compressor, it can take up to 3 hours for operation to begin after the unit is turned on.

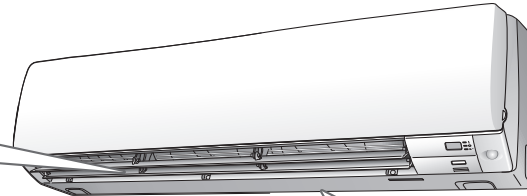
**Different sounds are heard.**

- **A sound like flowing water**
 - This sound is generated because the refrigerant in the air conditioner is flowing.
 - This is a pumping sound of the water in the air conditioner and can be heard when the water is pumped out from the air conditioner during COOL or DRY operation.
- **Blowing sound**
 - This sound is generated when the flow of the refrigerant in the air conditioner is switched over.
 - If the outdoor temperature is low, this sound is generated when the direction of the flow of the refrigerant in the piping changes at the start of defrost operation, after HEAT operation is stopped and the room temperature is stabilized.
- **Ticking sound**
 - This sound is generated when the cabinet and frame of the air conditioner slightly expand or shrink as a result of temperature changes.
- **Whistling sound**
 - This sound is generated when refrigerant flows during defrosting operation.
- **Clicking sound during operation or idle time**
 - This sound is generated when the refrigerant control valves or the electrical parts operate.
- **Clopping sound**
 - This sound is heard from the inside of the air conditioner when the exhaust fan is activated while the room doors are closed. Open the window or turn off the exhaust fan.

Outdoor unit

Operating sound is loud.

- When frost forms on the heat exchanger of the outdoor unit, the operating sound level increases slightly.

The outdoor unit emits water or steam.

- **In HEAT operation**
 - The frost on the outdoor unit melts into water or steam when the air conditioner is in defrosting operation.
- **In COOL or DRY operation**
 - Moisture in the air condenses into water on the cool surface of the outdoor unit piping and drips.

Blowing sound

- If the outdoor temperature is low, this sound is generated when the direction of the flow of the refrigerant in the piping changes at the start of defrost operation, after HEAT operation is stopped and the room temperature is stabilized.

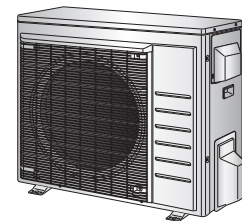



When the Need Arises

Troubleshooting



Before making an inquiry or a request for repair, please check the following.
If the problem persists, consult your dealer.

	<p>Not a problem This case is not a problem.</p>		<p>Check Please check again before requesting repairs.</p>
---	---	---	---

The air conditioner does not operate

Case	Description / what to check
OPERATION lamp is off.	 <ul style="list-style-type: none"> Has the circuit breaker been tripped or the fuse blown? Is there a power failure? Are batteries set in the remote controller?
OPERATION lamp is blinking.	 <ul style="list-style-type: none"> Turn off the power with the circuit breaker and restart operation with the remote controller. If the OPERATION lamp is still blinking, check the error code and consult your dealer. <p style="text-align: right;">▶ Page 37, 38</p>



The air conditioner suddenly stops operating

Case	Description / what to check
OPERATION lamp is on.	 <ul style="list-style-type: none"> To protect the system, the air conditioner may stop operating after sudden large voltage fluctuations. It automatically resumes operation in about 3 minutes.
OPERATION lamp is blinking.	 <ul style="list-style-type: none"> Are the air filters dirty? Clean the air filters. Is there anything blocking the air inlet or air outlet of the indoor unit or outdoor unit? Stop operation and after turning off the circuit breaker, remove the obstruction. Then restart operation with the remote controller. If the OPERATION lamp is still blinking, check the error code and consult your dealer. ▶ Page 37, 38

The air conditioner does not stop operating

Case	Description / what to check
The air conditioner continues operating even after operation is stopped.	 <ul style="list-style-type: none"> Immediately after the air conditioner is stopped <ul style="list-style-type: none"> The outdoor unit fan continues rotating for about another 1 minute to protect the system. While the air conditioner is not in operation <ul style="list-style-type: none"> When the outdoor temperature is high, the outdoor unit fan may start rotating to protect the system.

The room does not cool down / warm up

Case	Description / what to check
Air does not come out.	 <ul style="list-style-type: none"> In HEAT operation <ul style="list-style-type: none"> The air conditioner is warming up. Wait for about 1 to 4 minutes. During defrosting operation, hot air does not flow out of the indoor unit. When the air conditioner operates immediately after the circuit breaker is turned on <ul style="list-style-type: none"> The air conditioner is preparing to operate. Wait for about 3 to 10 minutes.
Air does not come out / Air comes out.	 <ul style="list-style-type: none"> Is the airflow rate setting appropriate? <ul style="list-style-type: none"> Is the airflow rate setting low, such as "Indoor unit quiet" or "Airflow rate 1"? Increase the airflow rate setting. Is the set temperature appropriate? Is the adjustment of the airflow direction appropriate?
Air comes out.	 <ul style="list-style-type: none"> Is there any furniture directly under or beside the indoor unit? Is the air conditioner in ECONO operation or QUIET OUTDOOR UNIT operation? ▶ Page 18 Is the air filter dirty? Is there anything blocking the air inlet or air outlet of the indoor unit or outdoor unit? Is a window or door open? Is an exhaust fan turning? Depending on the room conditions, number of occupants, or outdoor temperature and humidity, the set temperature may not be reached.

When the Need Arises

Water or mist comes out

Case	Description / what to check
Mist comes out of the indoor unit.	<input checked="" type="checkbox"/> • This happens when the air in the room is cooled into mist by the cold airflow during COOL or other operation.
Water is leaking from the indoor unit.	<input type="checkbox"/> • If the drain hose is crushed or clogged, water from the indoor unit may be unable to drain and start leaking. Stop operation of the unit immediately and contact your dealer.

Remote controller

Case	Description / what to check
The unit does not receive signals from the remote controller or has a limited operating range.	<input checked="" type="checkbox"/> • The batteries may be exhausted. Replace both batteries with new dry batteries AAA.LR03 (alkaline). For details, refer to “Preparation Before Operation”. ▶ Page 9 <input type="checkbox"/> • Signal communication may be disabled if an electronic-starter-type fluorescent lamp (such as inverter-type lamps) is in the room. Consult your dealer if that is the case. <input type="checkbox"/> • The remote controller may not function correctly if the transmitter is exposed to direct sunlight. <input type="checkbox"/> • Is there a device in the room that redirects remote controller signals? Some appliances such as TV speakers are equipped with these devices. If there is such a device in the room, the signals it emits may interfere with signals from the remote controller, preventing reception. <input type="checkbox"/> • Infrared rays from smartphones and game consoles may interfere with signals from the remote controller, preventing reception.
LCD is faint, is not working, or the display is erratic.	<input checked="" type="checkbox"/> • The batteries may be exhausted. Replace both batteries with new dry batteries AAA.LR03 (alkaline). For details, refer to “Preparation Before Operation”. ▶ Page 9
Other electric devices start operating.	<input checked="" type="checkbox"/> • If the remote controller activates other electric devices, move them away or consult your dealer.





Air has an odor

Case	Description / what to check
The air conditioner gives off an odor.	<input checked="" type="checkbox"/> • The room odor absorbed in the unit is discharged with the airflow. We recommend you to have the indoor unit cleaned. Please consult your dealer.
	<input checked="" type="checkbox"/> • The indoor unit is blowing out room odor it has absorbed (the smell of walls or carpeting, furniture, clothes, and so on). If the air conditioner has been used for a long time, there is a chance that a dirty heat exchanger or fan are emitting an odor. We recommend you to have the indoor unit cleaned. Please consult your dealer. Do not spray the air conditioner unit with any deodorizers.

When the Need Arises

Troubleshooting

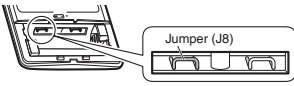
Others

Case	Description / what to check
The air conditioner suddenly starts behaving strangely during operation.	 <ul style="list-style-type: none"> The air conditioner may malfunction due to lightning or radio. If the air conditioner malfunctions, turn off the power with the circuit breaker and restart the operation with the remote controller.
The WEEKLY TIMER does not operate according to the settings.	 <ul style="list-style-type: none"> Check if the ON/OFF TIMER and the WEEKLY TIMER are set to the same time. Change or deactivate the settings in the ON/OFF TIMER. ▶Page 19, 20
HEAT operation cannot be selected, even though the unit is heat pump model.	 <ul style="list-style-type: none"> Check that the jumper (J8) has not been cut. If it has been cut, contact your dealer. 
The ceiling and walls around the indoor unit are black and dirty.	 <ul style="list-style-type: none"> Due to the circulation pattern of the air and static electricity, the air conditioner is causing airborne dirt and dust to stick to walls and other surfaces. Depending on the wallpaper type, dirt may adhere more easily. A thorough cleaning of the area around the air conditioner is recommended.
The ON/OFF TIMER does not operate according to the settings.	 <ul style="list-style-type: none"> Check if the ON/OFF TIMER and the WEEKLY TIMER are set to the same time. Change or deactivate the settings in the WEEKLY TIMER. ▶Page 21

Notes on the operating conditions

- If operation continues under any conditions other than those listed in the table,
 - A safety device may activate to stop the operation.
 - Dew may form on the indoor unit and drip from it when COOL or DRY operation is selected.
- *1, *2 Turning on switch on the outdoor unit PCB will extend the cooling operation range to 14°F (-10°C). Installing an air direction adjustment grille (sold separately) will further extend the operation range to -4°F (-20°C) for RX models or to -22°F (-30°C) for RK models. Please consult your dealer.

Mode	Operating conditions
COOL / DRY	Outdoor temperature : [RX models] : 50*1 - 115°F (10*1 - 46°C) [RK models] : 50*2 - 115°F (10*2 - 46°C) *1 -4°F (-20°C) *2 -22°F (-30°C) if an air direction adjustment grille (sold separately) is installed.
	Indoor temperature : 64 - 90°F (18 - 32°C) Indoor humidity : 80% max.
HEAT	Outdoor temperature : 5 - 75°F (-15 - 24°C) Indoor temperature : 50 - 86°F (10 - 30°C)

When the Need Arises

■ Call your dealer immediately

WARNING

When an abnormality (such as a burning smell) occurs, stop operation and turn off the circuit breaker.

- Continued operation in an abnormal condition may result in problems, electric shock or fire.
- Consult the dealer where you bought the air conditioner.

Do not attempt to repair or modify the air conditioner by yourself.

- Incorrect work may result in electric shock or fire.
- Consult the dealer where you bought the air conditioner.

If one of the following symptoms takes place, call your dealer immediately.

- The power cord is abnormally hot or damaged.
- An abnormal sound is heard during operation.
- The circuit breaker, a fuse, or the GFCI cuts off the operation frequently.
- A switch or a button often fails to work properly.
- There is a burning smell.
- Water leaks from the indoor unit.

Turn off the circuit breaker and call your dealer.



■ After a power failure

- The air conditioner automatically resumes operation in about 3 minutes. Please wait for a while.

■ Lightning

- If there is a risk lightning could strike in the neighborhood, stop operation and turn off the circuit breaker to protect the system.

■ Disposal requirements

- Dismantling of the unit, handling of the refrigerant, oil and other parts, should be done in accordance with the relevant local and national regulations.

When the Need Arises

Troubleshooting

The OPERATION lamp blinks

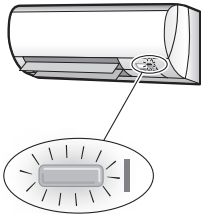

■ **Check the interval time between blinks of the OPERATION lamp.**

[Blink interval of about 0.5 seconds]
 This is a notification of an abnormality.
 Check the error code following the procedure below, and respond according to the instructions in the table.

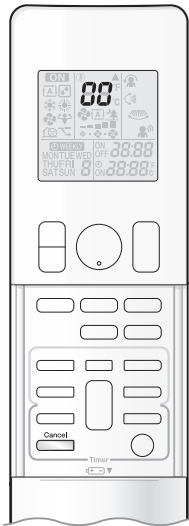

■ **Fault diagnosis by remote controller**

1. When is held down for about 5 seconds, "00" blinks in the temperature display section.

2. While pointing the remote controller at the indoor unit, press repeatedly.

A beep indicates a non-corresponding error code
 A long beep indicates a corresponding error code

3. When a long beep is produced, check the error code and respond according to the instructions in the table.

- To cancel the code display, hold down for about 5 seconds (the code display also clears if no button is pressed for a while).

CODE	Cause	Description / what to check
E7	The fan of the outdoor unit is stopped. • Is there any foreign matter inside the outdoor unit?	After turning off the circuit breaker, remove the foreign matter, then turn the power on again and operate.
L3, L4, L5	The temperature inside the outdoor unit has become too high, so operation has stopped. • Is there anything blocking the air outlet of the outdoor unit?	After turning off the circuit breaker, remove the obstruction, then turn the power on again and operate.
Other error codes, or if the error code cannot be checked		An abnormality has occurred.

In the case of error code U0 or F3

When the Need Arises

	CODE	MEANING
SYSTEM	00	NORMAL
	UA	INDOOR-OUTDOOR UNIT COMBINATION FAULT
	U0	REFRIGERANT SHORTAGE
	U2	OVER-VOLTAGE DETECTION
	U4	SIGNAL TRANSMISSION ERROR (BETWEEN INDOOR AND OUTDOOR UNIT)
INDOOR UNIT	A1	INDOOR UNIT PCB ABNORMALITY
	A6	FAN MOTOR (DC MOTOR) ABNORMALITY
	C4	INDOOR HEAT EXCHANGER THERMISTOR ABNORMALITY
	C9	ROOM TEMPERATURE THERMISTOR ABNORMALITY
OUTDOOR UNIT	EA	FOUR WAY VALVE ABNORMALITY
	E1	OUTDOOR UNIT PCB ABNORMALITY
	E3	HIGH PRESSURE SWITCH (HPS) ACTIVATED
	E5	OL ACTIVATION (COMPRESSOR OVERLOAD)
	E6	COMPRESSOR LOCK
	E7	DC FAN LOCK
	F3	DISCHARGE PIPE TEMPERATURE CONTROL
	H0	COMPRESSOR SYSTEM SENSOR ABNORMALITY
	H6	POSITION SENSOR ABNORMALITY
	H8	DC VOLTAGE / CURRENT SENSOR ABNORMALITY
	H9	OUTDOOR TEMPERATURE THERMISTOR ABNORMALITY
	J3	DISCHARGE PIPE THERMISTOR ABNORMALITY
	J6	OUTDOOR HEAT EXCHANGER THERMISTOR ABNORMALITY
	L3	ELECTRICAL PARTS HEAT FAULT
	L4	RADIATION FIN TEMPERATURE RISE
	L5	OUTPUT OVERCURRENT DETECTION
P4	RADIATION FIN THERMISTOR ABNORMALITY	

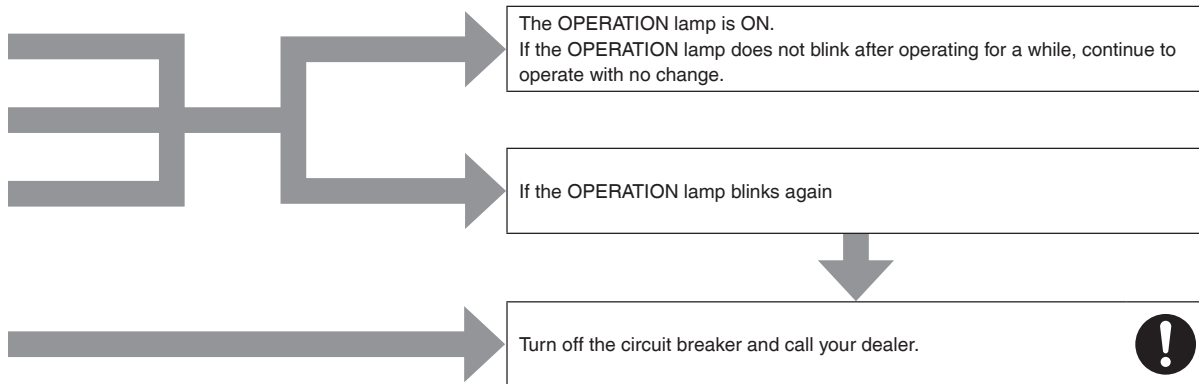

Quick Reference

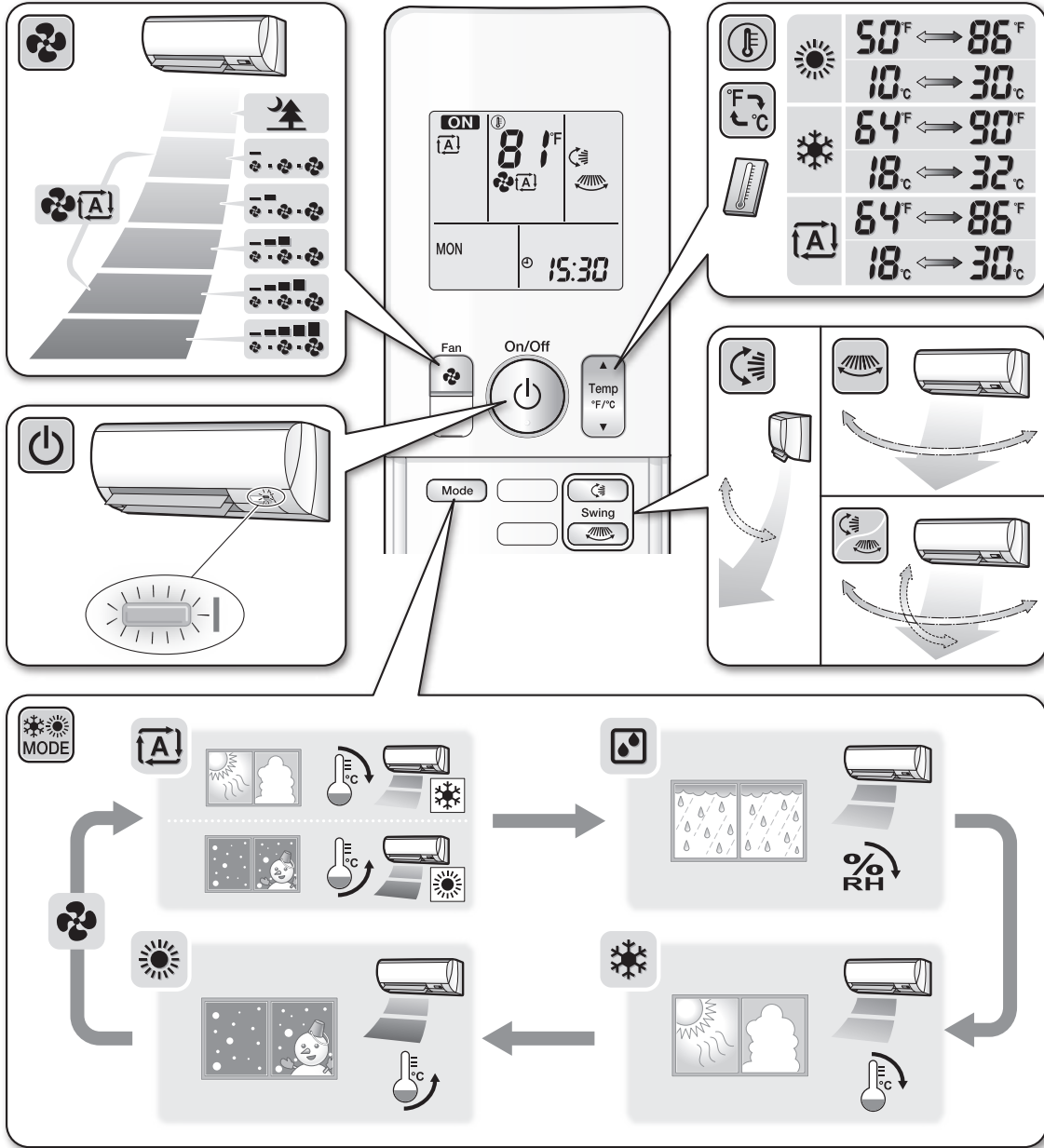

12.2 General Safety Consideration

1. General Safety Considerations

1-1 About the documentation

- The original documentation is written in English. All other languages are translations.
- The precautions described in this document cover very important topics, follow them carefully.
- The installation of the system, and all activities described in the installation manual and in the installer references guide MUST be performed by an authorized installer.

1-1-1 Meaning of warnings and symbols



DANGER

Indicates a situation that results in death or serious injury.



DANGER: RISK OF ELECTROCUTION

Indicates a situation that could result in electrocution.



DANGER: RISK OF EXPLOSION

Indicates a situation that could result in explosion.



WARNING

Indicates a situation that could result in death or serious injury.



CAUTION

Indicates a situation that could result in minor or moderate injury.



NOTICE

Indicates a situation that could result in equipment or property damage.



INFORMATION

Indicates useful tips or additional information.

Symbols used on the unit:

Symbol	Explanation
	Before installation, read the installation and operation manual, and the wiring instruction sheet.
	Before performing maintenance and service tasks, read the service manual.
	For more information, see the installer and user reference guide.
	The unit contains rotating parts. Be careful when servicing or inspecting the unit.

1-2 For the user



WARNING

If you are NOT sure how to operate the unit, contact your installer.



WARNING

This appliance is not intended for use by persons, including children, with reduced physical, sensory or mental capabilities, or lack of experience and knowledge, unless they have been given supervision or instruction concerning use of the appliance by a person responsible for their safety.

Children should be supervised to ensure that they do not play with the appliance.

Cleaning and user maintenance must not be carried out by children without supervision.



WARNING

To prevent electrical shocks or fire:

- Do NOT rinse the unit.
- Do NOT operate the unit with wet hands.
- Do NOT place any objects containing water on the unit.



CAUTION

- Do NOT place any objects or equipment on top of the unit.
- Do NOT sit, climb or stand on the unit.

1-3 For the installer

1-3-1 General

If you are NOT sure how to install or operate the unit, contact your dealer.

The manual contains specific information about the required qualification of the working personnel for maintenance, service and repair operations.

Every working procedure that affects safety should only be carried out by competent persons.



DANGER

- Do NOT touch the refrigerant piping, water piping or internal parts during and immediately after operation. It could be too hot or too cold. Give it time to return to normal temperature. If you must touch it, wear protective gloves.
- Do NOT touch any accidental leaking refrigerant.



WARNING

Improper installation or attachment of equipment or accessories could result in electrical shock, short-circuit, leaks, fire or other damage to the equipment. Only use accessories, optional equipment and spare parts made or approved by Daikin.



WARNING

Make sure installation, testing and applied materials comply with applicable legislation (on top of the instructions described in the Daikin documentation).



CAUTION

Wear adequate personal protective equipment (protective gloves, safety glasses,...) when installing, maintaining or servicing the system.



WARNING

Tear apart and throw away plastic packaging bags so that nobody, especially children, can play with them. Possible risk: suffocation.



WARNING

Provide adequate measures to prevent that the unit can be used as a shelter by small animals. Small animals that make contact with electrical parts can cause malfunctions, smoke or fire.



CAUTION

Do NOT touch the air inlet or aluminum fins of the unit.



CAUTION

- Do NOT place any objects or equipment on top of the unit.
- Do NOT sit, climb or stand on the unit.



NOTICE

Works executed on the outdoor unit are best done under dry weather conditions to avoid water ingress.

In accordance with the applicable legislation, it might be necessary to provide a logbook with the product containing at least: information on maintenance, repair work, results of tests, stand-by periods,...

Also, at least, following information MUST be provided at an accessible place at the product:

- Instructions for shutting down the system in case of an emergency
- Name and address of fire department, police and hospital
- Name, address and day and night telephone numbers for obtaining service
- ISO 5149 provides the necessary guidance for this logbook.

1-3-2 Installation site

- Provide sufficient space around the unit for servicing and air circulation as outlined in the unit installation manual.
- Make sure the installation site withstands the weight and vibration of the unit.
- Make sure the unit is level.

Do NOT install the unit in the following places:

- In potentially explosive atmospheres.
- In places where there is machinery that emits electromagnetic waves. Electromagnetic waves may disturb the control system, and cause malfunction of the equipment.
- In places where there is a risk of fire due to the leakage of flammable gases (example: thinner or gasoline), carbon fiber, or ignitable dust.
- In places where corrosive gas (example: sulfurous acid gas) is produced. Corrosion of copper pipes or soldered parts may cause the refrigerant to leak.

1-3-3 Refrigerant

If applicable. See the installation manual or installer reference guide of your application for more information.



NOTICE

Make sure refrigerant piping installation complies with applicable legislation. ISO 5149 is the applicable standard.



NOTICE

Make sure the field piping and connections are NOT subjected to stress.



WARNING

During tests, NEVER pressurize the product with a pressure higher than the maximum allowable pressure (as indicated on the nameplate of the unit).



WARNING

Take sufficient precautions in case of refrigerant leakage. If refrigerant gas leaks, ventilate the area immediately.

Possible risks:

- Excessive refrigerant concentrations in a closed room can lead to oxygen deficiency.
- In case of R410A or R32 refrigerant: Toxic gas might be produced if refrigerant gas comes into contact with fire.
- In case of CO₂ refrigerant: Refrigerant gas is toxic in high concentrations.



DANGER: RISK OF EXPLOSION

Pump down – Refrigerant leakage. If you want to pump down the system, and there is a leak in the refrigerant circuit:

- Do NOT use the unit's automatic pump down function, with which you can collect all refrigerant from the system into the outdoor unit. **Possible consequence:** Explosion of the compressor because of air going into the operating compressor.
- Use a separate recovery system so that the unit's compressor does NOT have to operate.



WARNING

ALWAYS recover the refrigerant. Do NOT release them directly into the environment. Use a vacuum pump to evacuate the installation.



NOTICE

- After all the piping has been connected, make sure there are no gas leaks.



NOTICE

- To avoid compressor breakdown, do NOT charge more than the specified amount of refrigerant.





DANGER: RISK OF EXPLOSION

Make sure there is no oxygen in the system. Refrigerant may only be charged after performing a leak test and vacuum drying.

Possible consequence: Explosion of the compressor because of oxygen going into the operating compressor.

- In case recharge is required, see the nameplate of the unit. It states the type of refrigerant and necessary amount.
- The unit is factory charged with refrigerant, but depending on pipe sizes and pipe lengths some systems require additional charging of refrigerant.
- Only use tools exclusively for the refrigerant type used in the system. This to ensure pressure resistance and prevent foreign materials from entering into the system.
- Charge the liquid refrigerant as follows:

If	Then
A siphon tube is present (i.e., the cylinder is marked with "Liquid filling siphon attached")	Charge with the cylinder upright. 
A siphon tube is NOT present	Charge with the cylinder upside down. 

- Open refrigerant cylinders slowly.
- Charge the refrigerant in liquid form. Adding it in gas form may prevent normal operation.



CAUTION

When the refrigerant charging procedure is done or when pausing, close the valve of the refrigerant tank immediately. If the valve is NOT closed immediately, remaining pressure might charge additional refrigerant. **Possible consequence:** Incorrect refrigerant amount.

1-3-4 Electrical

**DANGER: RISK OF ELECTROCUTION**

- Turn OFF all power supplies before removing the switch box cover, connecting electrical wiring, or touching electrical parts.
- Disconnect the power supply for more than 1 minute, and measure the voltage at the terminals of main circuit capacitors or electrical components before servicing. The voltage MUST be less than 50V DC before you can touch electrical components. For the location of the terminals, see the wiring diagram.
- Do NOT touch electrical components with wet hands.
- Do NOT leave the unit unattended when the service cover is removed.

**WARNING**

If NOT factory installed, a main switch or other means for disconnection, having a contact separation in all poles providing full disconnection under overvoltage category III conditions, MUST be installed in the fixed wiring.

**WARNING**

- ONLY use copper wires.
- Make sure the field wiring complies with the applicable legislation.
- All field wiring MUST be performed in accordance with the wiring diagram supplied with the product.
- NEVER squeeze bundled cables and make sure they do NOT come in contact with the piping and sharp edges. Make sure no external pressure is applied to the terminal connections.
- Make sure to install ground wiring. Do NOT ground the unit to a utility pipe, surge absorber, or telephone ground. Incomplete grounding may cause electrical shock.
- Ensure that the REFRIGERATING SYSTEM is grounded prior to charging the system with refrigerant.
- Make sure to use a dedicated power circuit. NEVER use a power supply shared by another appliance.
- Make sure to install the required fuses or circuit breakers.
- Make sure to install a ground leakage protector where required by local codes. Failure to do so may cause electrical shock or fire.
- When installing the ground leakage protector, make sure it is compatible with the inverter (resistant to high frequency electric noise) to avoid unnecessary opening of the ground leakage protector.

**CAUTION**

- When connecting the power supply: connect the ground cable first, before making the current-carrying connections.
- When disconnecting the power supply: disconnect the current-carrying cables first, before separating the ground connection.
- The length of the conductors between the power supply stress relief and the terminal block itself must be such that, in case the power supply is pulled loose from the stress relief, the current-carrying wires become taut before the ground wire becomes taut.

**NOTICE**

Precautions when laying power wiring:



- Do NOT connect wiring of different thicknesses to the power terminal block (slack in the power wiring may cause abnormal heat).
- When connecting wiring which is the same thickness, do as shown in the figure above.
- For wiring, use the designated power wire and connect firmly, then secure to prevent outside pressure being exerted on the terminal board.
- Use an appropriate screwdriver for tightening the terminal screws. A screwdriver with a small head will damage the screw heads and make proper tightening impossible.
- Over-tightening the terminal screws may break them.

Install power cables at least 3.3ft away from televisions or radios to prevent interference. Depending on the radio waves, a distance of 3.3ft may not be sufficient.

**WARNING**

- After finishing the electrical work, confirm that each electrical component and terminal inside the electrical components box is connected securely.
- Make sure all covers are closed before starting up the unit.

1-3-5 Disposal

When removing refrigerant from a system, either for servicing or decommissioning, it is recommended good practice that all refrigerant is removed safely.

- When transferring refrigerant into cylinders, ensure that only appropriate refrigerant recovery cylinders are employed.
- Ensure that the correct number of cylinders for holding the total system charge is available.
- Ensure that all cylinders to be used are designated for the recovered refrigerant and labelled for that refrigerant (i. e. special cylinders for the recovery of refrigerant).
- Cylinders should be complete with pressure-relief valve and associated shut-off valves in good working order.
- Empty recovery cylinders should be evacuated and, if possible, cooled before recovery occurs.
- The recovery equipment should be in good working order with a set of instructions concerning the equipment that is at hand and should be suitable for the recovery of all appropriate refrigerants including, when applicable, FLAMMABLE REFRIGERANT.
- In addition, a set of calibrated weighing scales should be available and in good working order.
- Hoses should be complete with leak-free disconnect couplings and in good condition.
- Consult the manufacturer if in doubt.
- The recovered refrigerant should be returned to the refrigerant supplier in the correct recovery cylinder, and the relevant waste transfer note should be arranged.
- Do not mix refrigerants in recovery units and especially not in cylinders.
- The evacuation process should be carried out prior to returning the compressor to the suppliers.
- Only electric heating of the compressor body should be employed to accelerate this process.
- When oil is drained from a system, oil drainage should be carried out safely.

1-4 Glossary

Your dealer

Sales distributor for the product.

Authorized installer

Technically skilled person who is qualified to install the product.

User

Person who is owner of the product and/or operates the product.

Applicable legislation

All international, national and local directives, laws, regulations and/or codes that are relevant and applicable for a certain product or domain.

Service company

Qualified company which can perform or coordinate the required service on the product.

Installation manual

Instruction manual specified for a certain product or application, explaining how to install, configure and maintain it.

Operation manual

Instruction manual specified for a certain product or application, explaining how to operate it.

Maintenance instructions

Instruction manual specified for a certain product or application, which explains (if relevant) how to install, configure, operate and/or maintain the product or application.

Accessories

Labels, manuals, information sheets and pieces of equipment that are delivered with the product and that need to be installed according to the instructions in the accompanying documentation.

Equipment sold separately

Equipment made or approved by Daikin that can be combined with the product according to the instructions in the accompanying documentation.

Field supply

Equipment NOT made by Daikin that can be combined with the product according to the instructions in the accompanying documentation.

13. Options

13.1 Option List

13.1.1 Indoor Unit

	Option Name	Model Name
1	Wired remote controller ★1	BRC944B2
2	Wired remote controller cord (shielded wire)	Length 9.8 ft (3 m)
		Length 26.3 ft (8 m)
3	Wireless LAN connection adaptor	AZAI6WSCDKB
4	Wiring adaptor for timer clock / remote controller ★2 (normal open pulse contact / normal open contact)	KRP413BB1S
5	Central remote controller ★3	DCS302C71
6	Unified ON/OFF controller ★3	DCS301C71
7	Schedule timer controller ★3	DST301BA61
8	Interface adaptor for DIII-NET (residential air conditioner)	KRP928BB2S
9	Titanium apatite deodorizing filter (without frame) ★4	KAF970A48
10	Remote controller loss prevention with chain	KKF910A4

Notes: ★1 3 m (BRCW901A03) or 8 m (BRCW901A08) length wired remote controller cord is necessary.
 ★2 Timer clock and other devices; obtained locally.
 ★3 An interface adaptor (KRP928BB2S) is also required for each indoor unit.
 ★4 Standard accessory.

13.1.2 Outdoor Unit

	Option Name	Model Name
1	Air direction adjustment grille	KPW063B4
2	Back protection wire net	KKG063A42
3	Drain plug ★	KKP937A4
4	Drain pan heater	FTDBHML
		KEH063A4E KEH063A4EA
5	Snow hood (intake side plate)	KPS063A41
6	Snow hood (intake rear plate)	KPS063A44
7	Snow hood (outlet)	KPS063A47

Notes: ★ Standard accessory

13.2 <BRC944B2> Wired Remote Controller Installation Manual

⚠ CAUTION

1. No switch box or staple is supplied. Prepare them locally.
2. No remote controller cord is supplied. Prepare the optional remote controller cord 4 wire.
3. Be sure to turn off the power to any apparatus connected prior to mounting.
4. Prior to mounting equipment, touch something metallic such as a doorknob to remove static electricity from your body. Never touch the remote controller board or the adapter board.
5. Keep the wiring away from any other power source lines to avoid electric noise (external noise).
6. Select a flat surface, wherever possible, to mount the remote controller. To prevent deformation of the cases, do not overtighten the mounting screws.

1. Securing the remote controller lower case

Insert a bladed screwdriver into the concave (凹) in the remote controller lower case to remove the upper case assembly (two locations).

The remote controller board is located on the upper case. Take care not to scratch the board with the screwdriver.

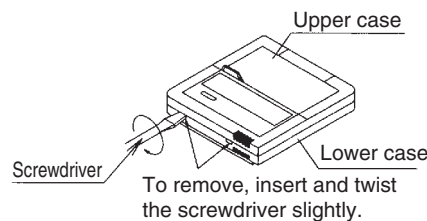

(1) Exposed mounting

Secure the remote controller lower case with the two supplied wood screws.

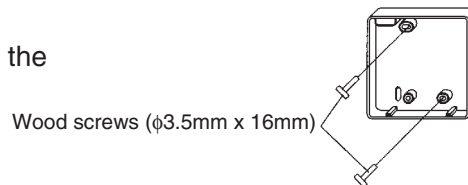

(2) Embedded mounting

Secure the remote controller lower case with the two supplied machine screws.

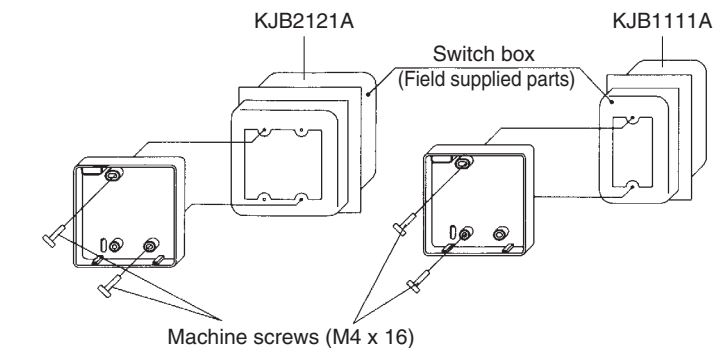

For the field supplied switch box, use optional accessories KJB1111A or KJB2121A.

2. Securing the remote control adapter

Remove the upper case of the remote control adapter and secure the lower case assembly.

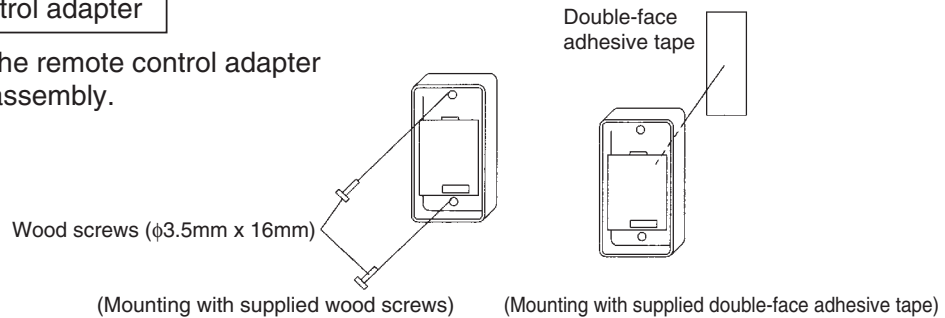

3. Wiring

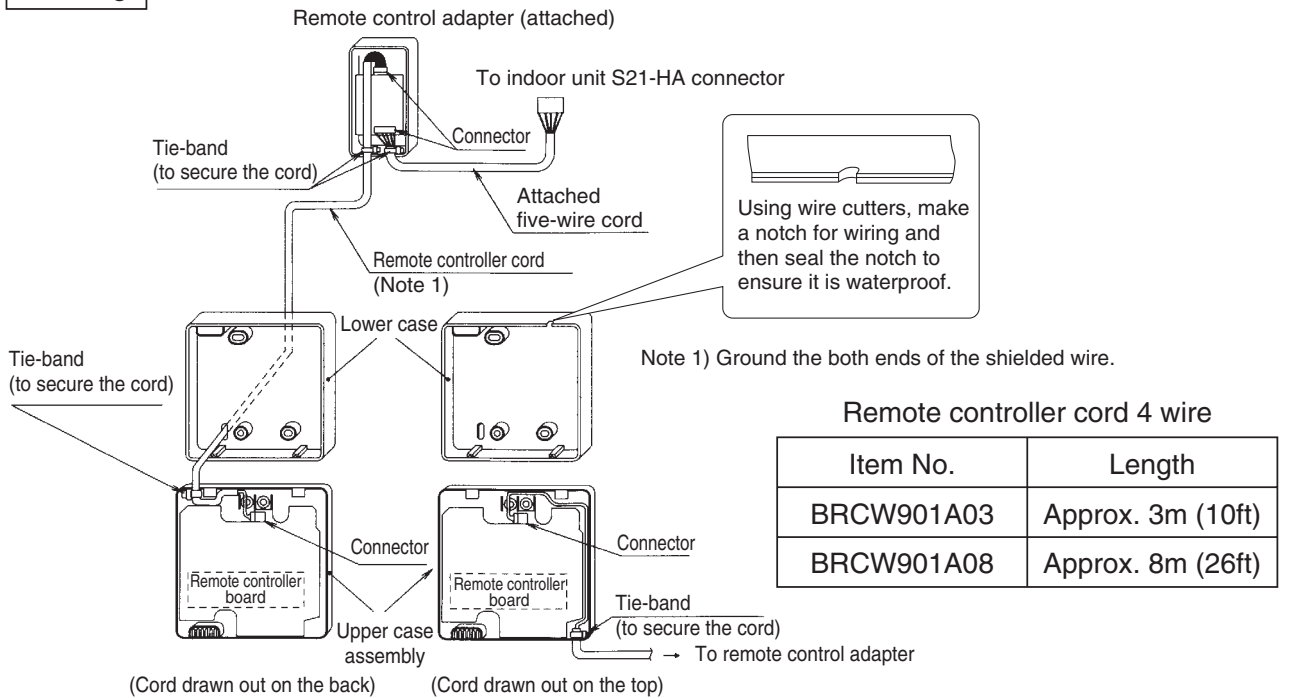

4. Placing the upper case assembly of the remote controller and the upper case of the remote controller adapter back into their original positions

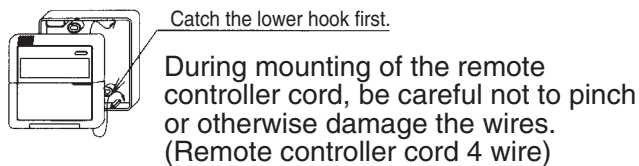

5. Temperature indication change

To change from Celsius temperature indication to Fahrenheit one

Press and hold down  at the same time for 5 seconds while the Celsius temperature is indicated.

← See Operation Manual



13.3 <BRC944B2> Wired Remote Controller Operation Manual

Controller Commands and their Corresponding Functions

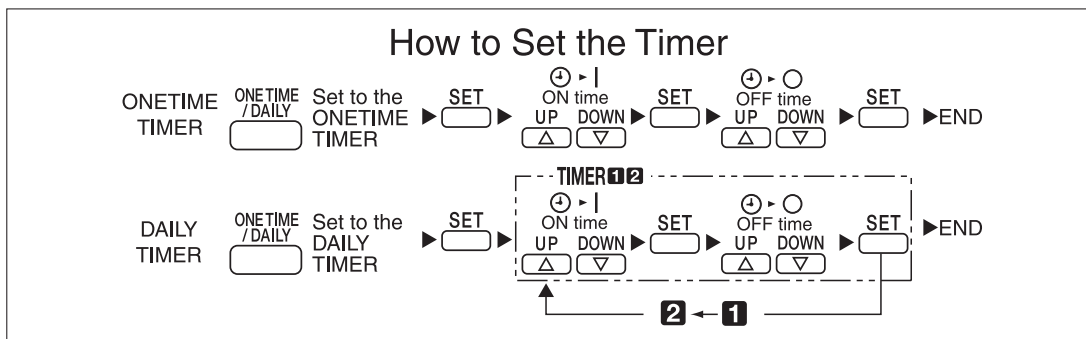
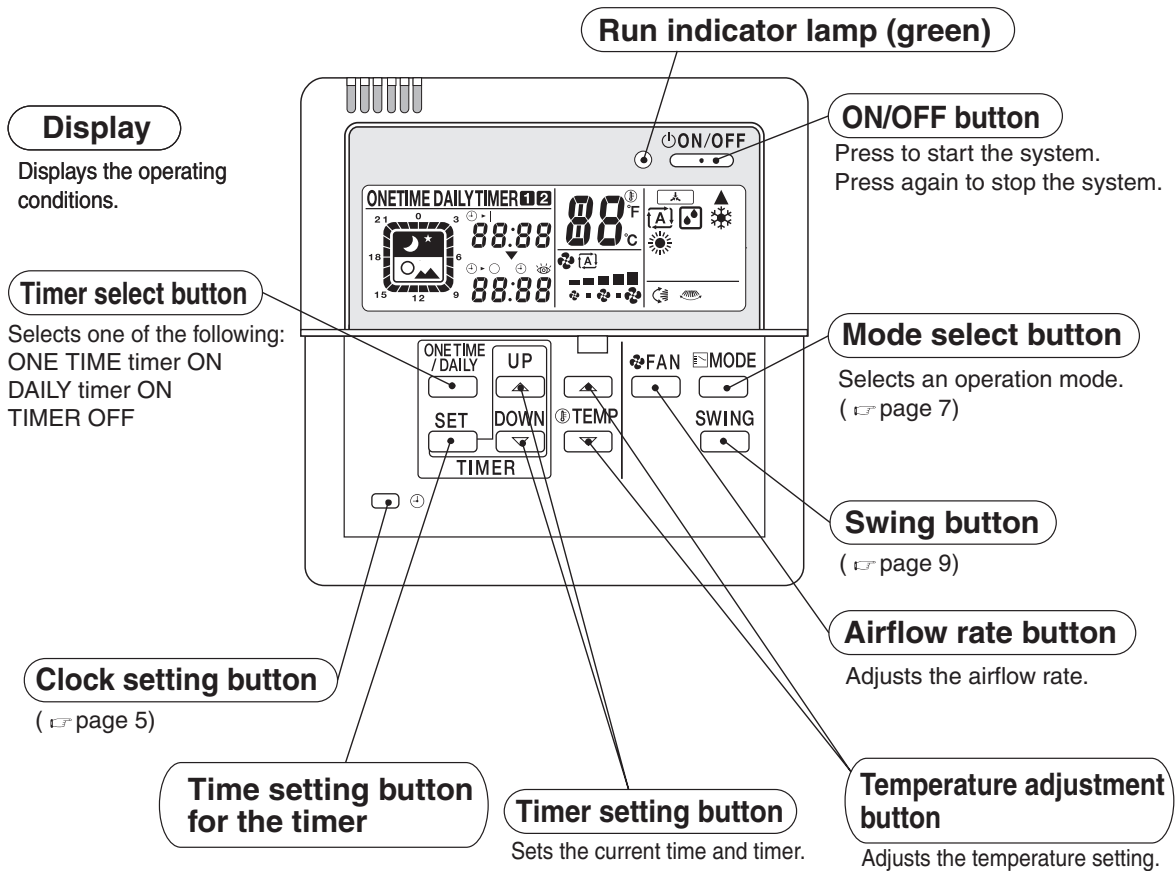

CAUTION

- This remote controller cannot be used together with a standard wireless remote controller. Otherwise, what appears on this remote controller's display may fail to correspond to actual operating conditions.

Preparation before Operation

■ Checking the power

If nothing appears on the remote controller's display, turn on the circuit breaker.

■ Setting the current time

1 Press .



The current time starts blinking.
0:00 lights up.



2 Press and set the current time.

- Hold the button down to rapidly advance the time.

3 Press .

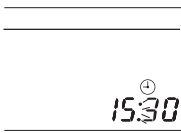

: blinks.

(This completes the current time setting)

- The clock's accuracy is ±30 seconds per month.

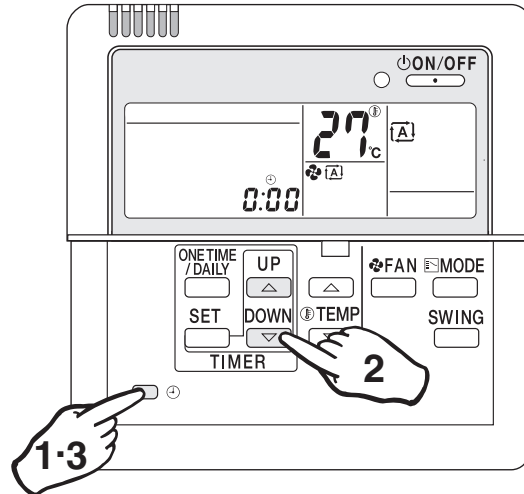

Notes

To use the unit efficiently

- Avoid overcooling or overheating. Moderate room temperature setting contributes to power saving.

Recommended temperature setting

For cooling 26~28°C (79°F~82°F)

For heating 20~22°C (68°F~72°F)
- Hang a blind or a curtain on the window. This will enhance the cooling/heating effect by intercepting direct sunlight and drafts.
- A clogged air filter reduces the cooling/heating effect and wastes energy. Clean the air filter monthly (every two weeks as required) or so.

Please take note of the following points

- Electric power is consumed even when the air conditioner is not in operation.
- When the unit is not used for a long period of time such as during off-season, turn off the breaker.

Operating conditions

- If the operation is continued under any conditions other than the following, the safety device may work to stop the operation. Also, dew may form on the indoor unit and drip from it. (Cooling/DRY)

Cooling	Outdoor temp.	-10 to 46°C (14°F to 115°F)
	Room temp.	18 to 32°C (64°F to 90°F)
	Indoor humidity	Less than 80%
DRY	Outdoor temp.	-10 to 46°C (14°F to 115°F)
	Room temp.	18 to 32°C (64°F to 90°F)
	Indoor humidity	Less than 80%
Heating	Outdoor temp.	-15 to 20°C (5°F to 68°F)
	Room temp.	Less than 27°C

- Operation limit differ according to the model.

Preparation before Operation

■ Setting Temperature Indication change

Temperature indication can be changed between Celsius and Fahrenheit before use.

To change from Celsius temperature indication to Fahrenheit one

- 1 Press and hold down  at the same time for 5 seconds while the Celsius temperature is indicated.

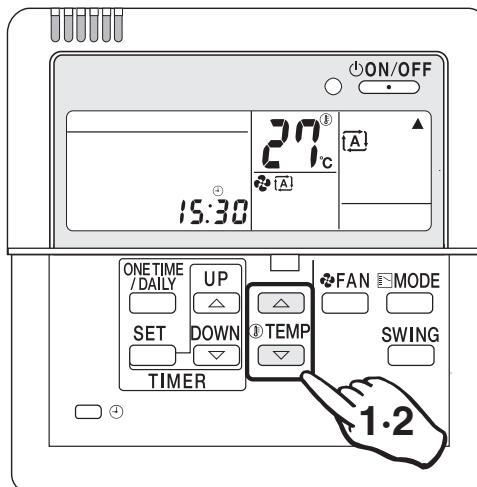
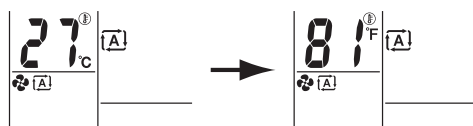

To change from Fahrenheit temperature indication to Celsius one

- 2 Press and hold down  at the same time for 5 seconds while the Fahrenheit temperature is indicated.

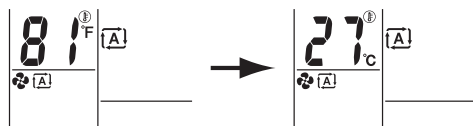

Notes

■ Temperature indication change between Celsius and Fahrenheit on the remote controller

- Change the temperature indication in the modes other than the DRY mode.
In the DRY mode, temperature indication setting cannot be changed because the temperature is not indicated.
- When the Fahrenheit temperature indication is changed to Celsius one, the temperature value (0.5°C) will be rounded up. Thus, the preset temperature may be changed.

Example:

A preset temperature of 65°F (equivalent to 18.5°C) will be changed to 19°C (66°F) by changing the temperature indication. In this case, if you change the Celsius temperature indication again to the Fahrenheit one, the preset temperature is shown not as 65°F but as 66°F (equivalent to 19°C). If the preset temperature is 66°F (equivalent to 19°C) and is changed to the Celsius temperature indication, the indication becomes 19°C (66°F). In this case, no change by the temperature indication change is observed.

- When the temperature indication change is set, the preset temperature is transmitted to the indoor unit so that the reception sound will be heard from the indoor unit.

Automatic·DRY·Cooling·Heating Operation

Select your desired operation mode.

Once preset, the system can get restarted in the same operation mode.

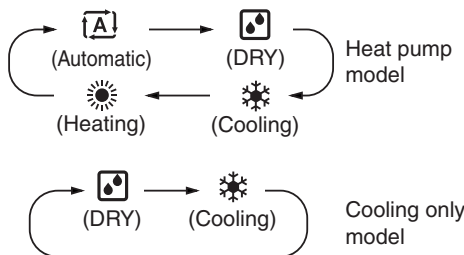
- 1** Press  to select your desired operation mode.
- Each time the button is pressed, the mode changes as follows.
- 
- The system does not have the FAN mode.

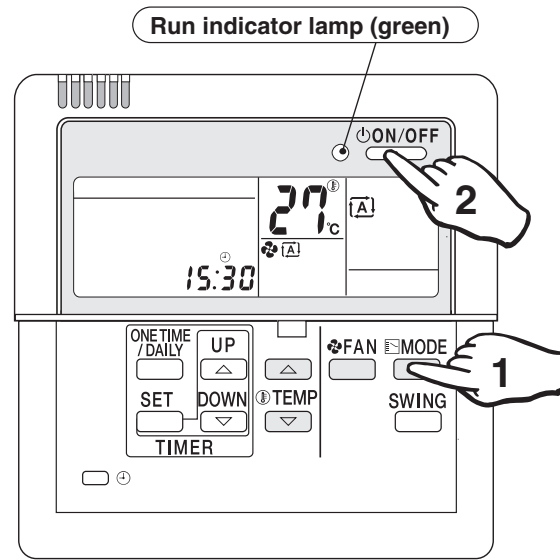

- 2** Press  .
- The run indicator lamp lights up.

■ To stop the operation:

- Press  again.
- The run indicator lamp goes out.

Automatic operation

- In Automatic, the temperature setting and operation mode (DRY, Cooling or Heating) are automatically selected according to the room temperature and outdoor temperature at the time of starting operation.

DRY operation









- In this mode, humidity is removed from the air.



Note

- While running in the DRY mode, you may feel cool or warm air from the air outlet. In this case, readjust the airflow direction with the vertical airflow direction louvers. (except Duct Connected type)

■ To adjust the temperature and airflow rate:

Operation mode Setting to be adjusted	Automatic	Cooling	Heating	DRY
 ⓈTEMP  (Temperature)	Temperature is adjustable. Recommended temperature Cooling : 26°C-28°C (79°F~82°F) Heating : 20°C-22°C (68°F~72°F)			Temperature cannot be adjusted.
  (Airflow rate)	Five levels of airflow rate setting from "  " to "  " plus "  " are available. 			Airflow rate cannot be adjusted.

- When the unit runs in the cooling or heating mode at a low airflow rate, the cooling or heating effect may be insufficient.

■ To adjust the airflow direction:

( page 9)

Heating operation

- Since the heating operation is performed by taking the heat from outdoor into the room, the heating capacity decreases as the outdoor temperature lowers. If the room is not heated sufficiently, it is recommended to use other heating appliance at the same time.
- Since the air conditioner heats the whole room by circulating hot air, it takes some time to heat the entire room completely.
- If the outdoor unit gets frosted during heating operation, the heating capacity is decreased. In this case, the unit starts defrosting operation.
- No hot air comes out of the indoor unit during defrosting operation.

Adjusting Airflow Direction

Adjust the airflow direction for maximum comfort.

To adjust the Airflow Direction

- 1 Press  during operation.
 - Each time the button is pressed, the airflow direction louvers change their movement.

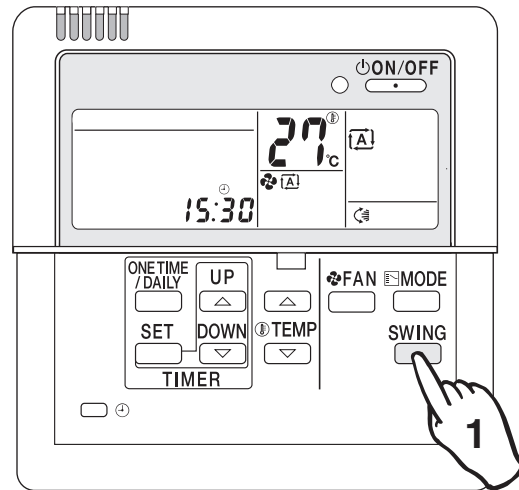

■ Wall Mounted Types (without horizontal swing function)

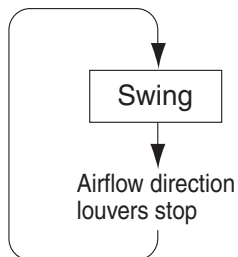

The horizontal airflow direction louvers move up and down.

The louvers stop just when the button is pressed.

Adjustment of horizontal airflow direction

- The automatic moving range of the horizontal airflow direction louvers varies depending on the operation mode.



Notes

- In fixing the horizontal airflow direction, keep the horizontal airflow direction louvers tilted downward in the heating mode, and keep them nearly horizontal level in the cooling or DRY mode. This will enhance the cooling and heating effect.
- On the air conditioners with vertical and horizontal swing function, be sure to adjust the airflow directions using the remote controller. Do not forcibly adjust louvers by hand or a malfunction may occur.

■ Wall Mounted Type (with horizontal swing function)

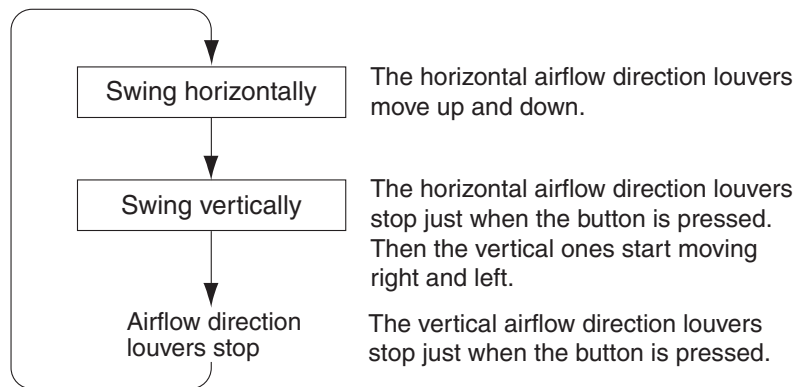

- The vertical and horizontal louvers cannot move at the same time.

■ Duct Connected Type (without swing function)

This function cannot be used.



Note

- The operating procedure and remote controller display are different depending on the indoor unit being connected. Read **How to Adjust the Airflow Direction** in the air conditioner's Operation Manual.

Timer Operation

The Timer Operation feature automatically turns off operation when you go to sleep and turns it back on when you wake up.

Use the DAILY Timer mode on weekdays, and the ONE TIME timer mode on weekends.

■ To select the ONE TIME timer mode:

1 Press  to select the ONE TIME timer mode.

- Each time the button is pressed, the modes change as follows.

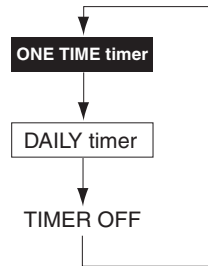

The timer lamp lights up.

■ To cancel the timer settings:

1 Press  to clear the timer settings.

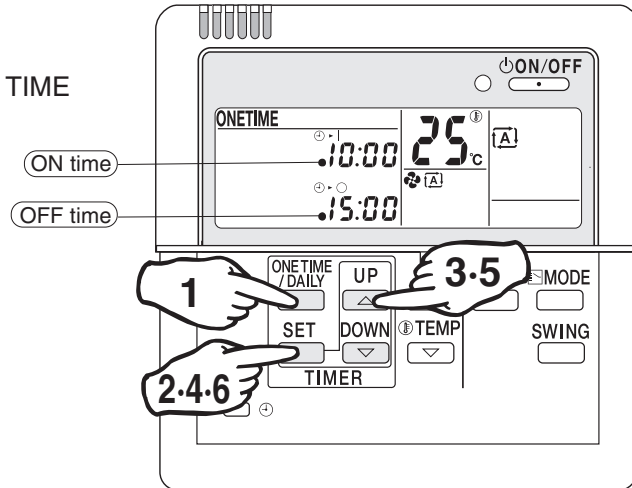
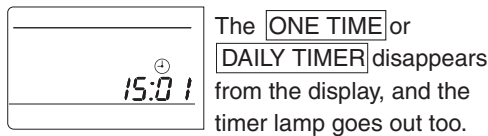

(Timer settings displayed)



Notes

- Even when the timer has been off, its programmed settings are still in memory.
- If the system has the timer control ON but you start and stop it manually using the ON/OFF button before the designated ON time, the system will restart again at the programmed ON time.

Precautions in setting the timer

- Before starting the timer operation, make sure the current time is correct. If not, set the clock correctly. (☞ page 5)
- In making time settings, --:-- is displayed to make it easy to disable the timer too.
- If one minute has passed before making any timer setting, the previous timer settings are reintroduced and the timer is on standby. In this case, use the  (time setting) button and make your desired timer settings.

Timer operation

- When the ON timer is programmed, the system starts one hour (maximum) earlier so that the temperature set by the remote controller is reached just in time.
- When the ONE TIME timer is programmed, the current time is no longer displayed.

■ ONE TIME timer

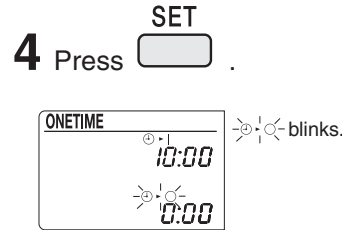
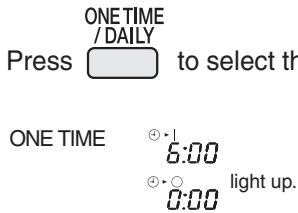

Once the timer has been activated and then deactivated, it is in the OFF mode. The ON or OFF timers can be programmed.

1 Press  to select the ONE TIME timer. **4** Press .



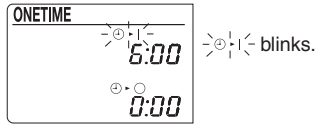

2 Press .

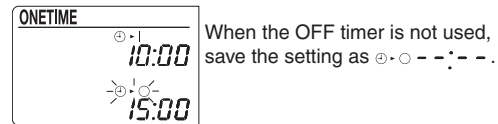

5 Press   to make the OFF timer setting.



3 Press   to make the ON timer setting.

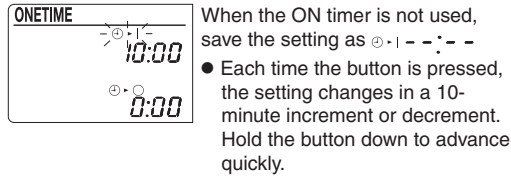

6 Press  .
(The ONE TIME timer is now programmed.)

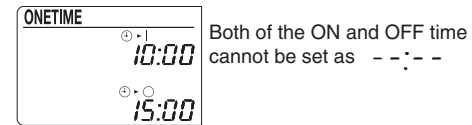

Example of display with the ONE TIME timer programmed

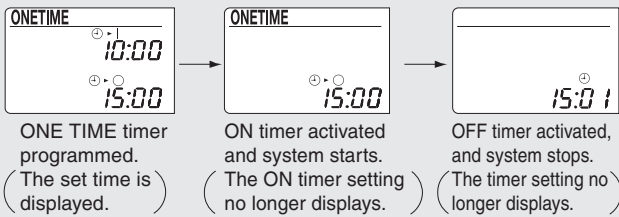

Notes

- In the following cases, reset the clock (the time setting is kept in the memory).
 - The circuit breaker has been activated.
 - The power fails.

Timer Operation

■ To select the DAILY timer mode:

1 Press  to select the DAILY timer mode.

- Each time the button is pressed, the modes change as follows.

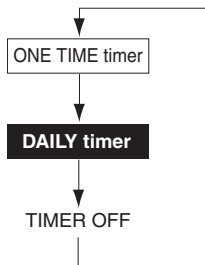

The timer lamp lights up.

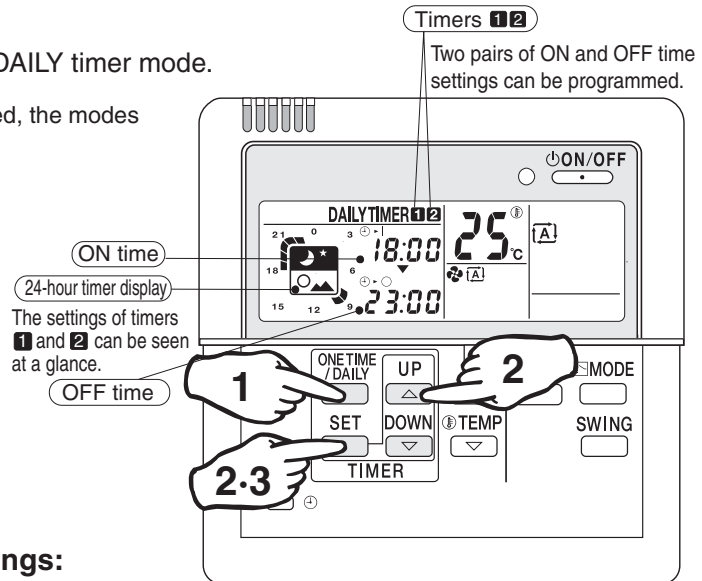

(Timer settings displayed)

■ To cancel the timer settings:

1 Press  to clear the timer settings.

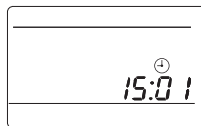

The **ONE TIME** or **DAILY TIMER**, and the timer lamp are no longer displayed.

Example of display with DAILY timer programmed

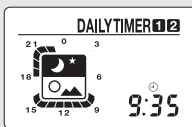

Timers **1** and **2** programmed.

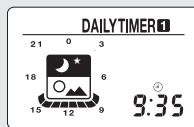

Timer **1** alone programmed.



Note

- The system starts and stops repeatedly until the DAILY timer is set off. Before you leave home for a long time, set the DAILY timer off.







■ DAILY timer

After programming, the system starts and stops each day at the preset times. Two pairs of time settings can be programmed.

(Example: 8:00 ~ 10:00, and 18:00 ~ 23:00)

1 Press  to select the DAILY timer.  lights up. DAILY timer indication appears.

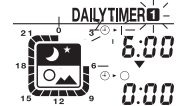
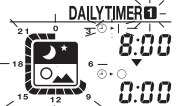
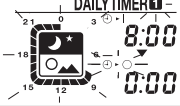
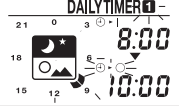
2 Make the ON and OFF time settings. ● Take the steps from ① to ⑧.
Program example: 8:00 ~ 10:00, and 18:00 ~ 23:00

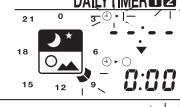
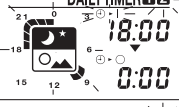
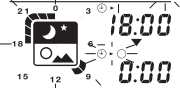
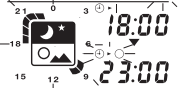
Settings		Procedure	
		Press 	Press  to make the timer setting. 
	ON time setting ● When the timer 1 is not used, save the setting as ①-1-:-:-	① 	② 
	OFF time setting	③ 	④ 
	ON time setting ● When the timer 2 is not used, save the setting as ⑤-1-:-:-	⑤ 	⑥ 
	OFF time setting	⑦ 	⑧ 

3 Press . The DAILY timer is now programmed.



Note

- If the following appears on the display, the timer must be reprogrammed.

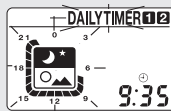

The 24-hour timer display is blinking.

This means that Timers **1** and **2** are programmed for the same time settings. New time settings must be made.



The 24-hour timer display is blinking.

This means that the timer has not been programmed yet.

Cleaning

Cleaning the remote controller

- Wipe it clean with soft, dry cloth.
Do not use any water hotter than 40°C (104°F), or volatile liquids such as benzene, gasoline and thinner, polishing powder, or anything hard such as a scrub brush.

When the unit is not used for a long time

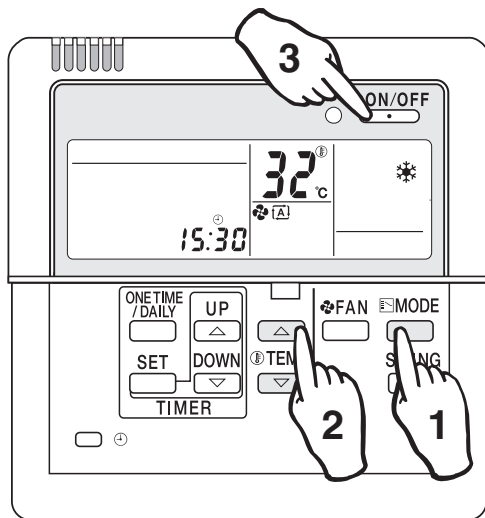

- ① On a sunny day, keep the system running for half a day in the FAN mode to dry it up inside.

FAN mode

- 1 Press to select the cooling mode.
 - 2 Press to adjust the set temperature to 32°C (90°F).
 - 3 Press .
 - The airflow rate remains the same, and is not adjustable.
 - Run the system when the room temperature is below 28°C (82°F).
- ② Finally turn off the circuit breaker dedicated for the room air conditioner.
 - ③ Clean the air filter and place it back into position.

13.4 <KRP413BB1S> Wiring Adaptor for Timer Clock / Remote Controller

Safety Precautions

- Read these safety precautions carefully before installing the unit, and be sure to install the unit properly.
- This manual classifies precautions to the user into the following two categories. These warnings and cautions are for your safety. Follow them.

⚠ WARNING	Faulty installation can result in death or serious injury.
⚠ CAUTION	Faulty installation can result in serious injury, damage to property, or other serious consequences.

- After installation is complete, test the unit to confirm that it is working properly, and instruct the owner its proper use.

⚠ WARNING

- Installation should be left to the dealer from whom you purchased the unit, or another qualified professionals.
- Install the unit securely according to the installation manual. Faulty installation may lead to electric shock or fire.
- Be sure to use the supplied or specified parts. Using other parts may lead to electric shock or fire.
- Install the unit securely in a location that will support its weight. If installed in a poor location or improperly installed, the unit may not work as intended.
- For electrical work, follow local electric standards and the installation manual. Faulty installation may lead to fire or electric shock.
- Do not bundle the power cord, or attempt to extend it by splicing it with another cord or by using an extension cord. Do not place any other load on the power circuit used for the unit. Improper wiring may lead to electric shock, heat generation or fire.
- Use dedicated wiring for all electrical connections, and be sure to arrange the wiring so that force applied to the wiring will not damage the terminals. Poor wiring or installation may cause electric shock, heat generation or fire.

⚠ CAUTION

- Before installation, unplug the air conditioner to ensure safety. Failure to do so may cause electric shock.
- Static electricity may damage electric components. Before connecting cables and communication lines, and operating the switches, be sure to discharge any electrical charge from your body (by, for example, touching the earth line)
- Do not install the unit in a location where it may be exposed to flammable gases. If gas leaks and build up around the unit, it may catch fire.
- Do not place the wiring close to the power cord, inter-unit cable, or pipes which generate noise. Treat the wiring with care.

1. Functions and Features

- On/Off setting
- Switching between Instantaneous Contact/Normal Contact
- Connection with fan coil remote controller
- Automatic reset after power failure
- Output of normal operation signals/malfunction signals

2. Field Wiring

For interconnecting wiring, use Daikin KDC100A12 cable (not supplied) or other similar cable. Use a vinyl-covered wire or cable with four conductors each with a thickness of 0.2 to 1.25 mm².

■ Optional cable KDC100A12 (without connectors)

Specifications: 0.2 mm² × 4 core (sheathed)
 Outer diameter: φ5.3
 Length: 100 m
 Colour: Grey

Note : Keep any wiring for the control unit away from the power cord to prevent electrical noise.

Installation ①

1 Installation diagram

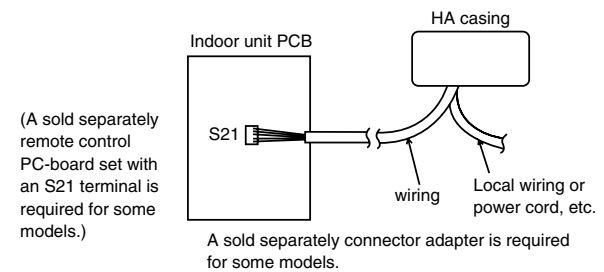

2 Components

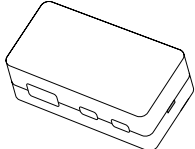
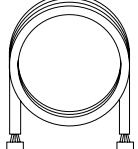
① HA casing ASSY (Remote Control PCB is attached in the HA casing.) 	② Wiring (approx. 0.8 m) (Cannot be made longer.) 
③ Accessories Binding band (6 pcs.) • Screws for attaching to the wall (3 pcs.)	
④ Installation manual	

Installation ②

Attaching HA Case ASSY

- Use the 3 supplied screws to attach the HA casing ASSY.

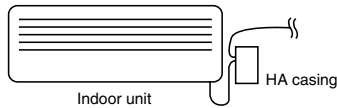

Install the HA casing ASSY as close to the indoor unit as possible.

① Removal of upper HA casing

- (1) Insert a flat-blade screwdriver into the groove between the upper and lower HA casings.

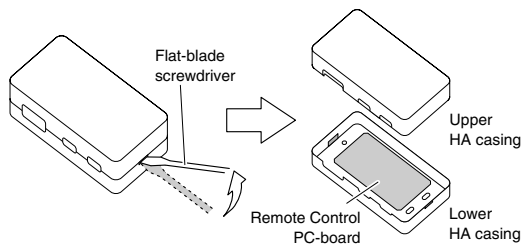

- (2) Lift the handle of the screwdriver upward.

- ② Mount and secure the lower HA casing directly on the wall with the provided screws inserted into the screw holes (a round hole and two ellipse holes) of the casing.

NOTE Mount the HA casing in a direction where the wiring through-holes will be hidden in order to prevent infants from putting their fingers into the HA casing and the LED light on the internal PC-board from leaking outside.

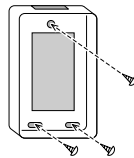

- ③ After connecting the cables (refer to the following sections), replace the case front. Be careful not to damage the wiring in the case.

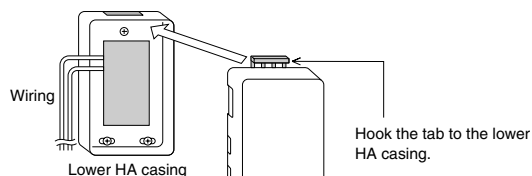

Press the lower part of the upper HA casing and press fit it onto the lower HA casing.
Press the upper HA casing precisely until a clicking sound is heard.

Wiring ①

1. Wiring

- ① Connect one end of the wiring to connector S21 of the PCB in the indoor unit.
- ② Connect the other end of the wiring to connector S6 of the Remote Control PCB.
- ③ Connect field wiring according to the functions assigned to each connection terminal of the Remote Control PCB.
- ④ Secure all wires.

1 Securing wires in the HA casing ASSY

① Connection of wiring

Connect the wiring to the connector terminals.

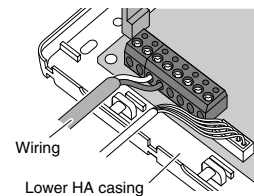

② Fixation of wiring

- (1) Insert the provided binding band under the pillar of the HA casing and secure the covers of the wiring with the binding band.

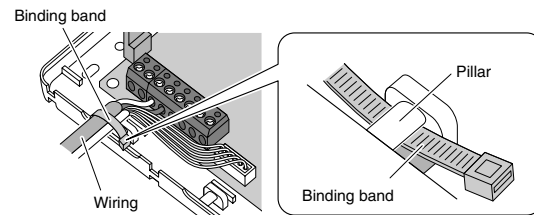

- (2) Insert the second binding band into the groove on the side of the HA casing and fix the wiring securely so that the wiring will not be disconnected.

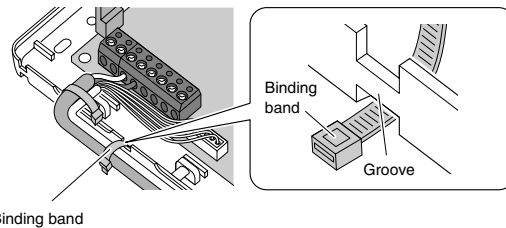

A large number of wires

Make a slit with an appropriate tool, such as a cutter knife, on the thin part of the upper HA casing along the frame. Then cut the part with an appropriate tool, such as a pair of nippers.

(NOTE) Cut off only the thin part required for wiring.

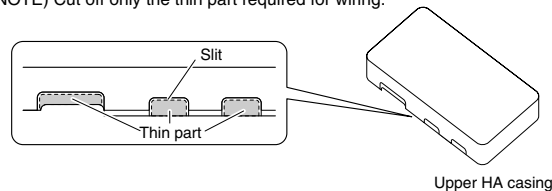

2 Securing wires in the indoor unit

- The method for securing wire varies depending on the model of the air conditioner. See your air conditioner installation manual for details.

Wiring ②

2. Automatic Reset After Power Failure

- This PCB stores the following data in the event of a power failure (the storage period is limitless).
 - ① On/Off (see Note 1)
 - ② Operation modes (see Note 2)
 - ③ Temperature setting
 - ④ Air flow rate
 - ⑤ On/Off status of remote controller
- (Note 1 When SW1-2 is in Off mode, the unit will not be activated.)
 (Note 2 The following settings apply to the models below.)

Mode before the power outage	COOLING	HEATING
Room air conditioner		
Models with Humid heating and Reheating dehumidifying functions.	DRY COOLING	HUMID HEATING
Models with Reheating dehumidifying function.		HEATING

- (Note 3 Not all settings will be saved (e.g., humidity or swing settings will not be saved).)
 (Note 4 Since a stop due to a momentary power failure cannot be detected, automatic reset may not be possible.)

3. Monitor Signal Output (normal operation and malfunction)

- Maximum length of the wiring is 100 m. No external power supply is required.

1 Monitor signal output for LED

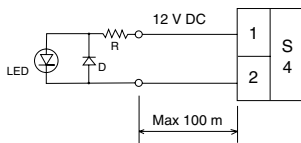

■ Locally procured parts

Item	Manufacturer	Type
LED	Rohm	SLR-342
D	Rohm	1SS133
R		510 ohm 1/4W

2 Monitor signal output (normal operation and malfunction) using external relay contacts

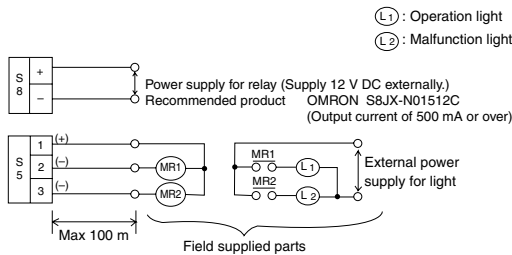

■ Field procured parts (Recommended external relay contacts)

Manufacturer	Type	Coil rated voltage	Coil resistance
Omron	MY relay	12 V DC	160 ohm ± 10%

4. Connection with Remote Controller

Example connections with three kinds of remote controllers are shown below. Note: These connections cannot be used in combination.

1 Remote control with switch (field supply)

- Set SW1-1 to Off and select Operation Mode 1.



<Instantaneous Contact>

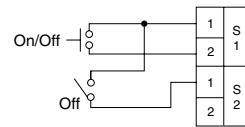

- The remote controller most recently used (local or air conditioner) takes precedence.
- Use a remote controller with a pulse width of 100 msec or more.

<Normal Contact>

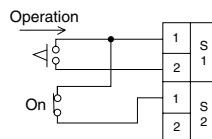

- Power On/Off cannot be controlled from the unit's remote controller. (Three beeps for signal reception will be heard continuously when the wireless remote controller is operated.)
- When power is restored after a power failure in this mode, On or Off is determined according to the current settings of the remote controller.

2 Fan coil remote controller

- Set SW1-1 to On and select Operation Mode 2.
- Most settings (power On/Off, air flow rate, mode change) cannot be made using the air conditioner's remote controller.
- When power is restored after a power failure in this mode, On or Off is determined according to the current settings of the remote controller.
- When the Cooling/Heating mode is changed, use the air conditioner's remote controller to adjust the temperature.

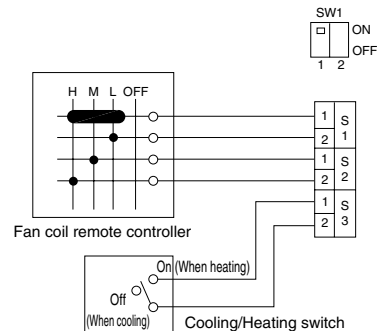

Test Operation and Confirmation

1. When the System is Not Working

- Is the air conditioner working properly?
- Are the connectors of the wiring properly connected?
- Are the remote controller and field wiring properly connected?
- Are all switch settings correct?
- If there is nothing apparently wrong, conduct a diagnostic check using the following procedure.

■ Diagnostic check

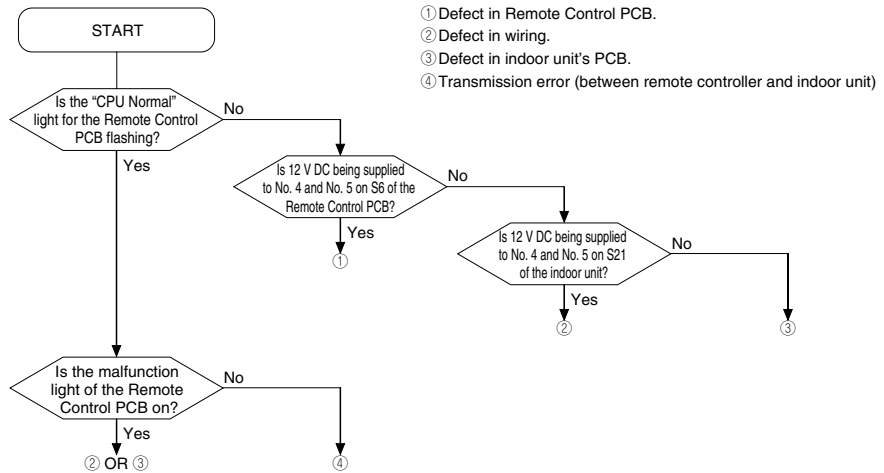

2. Switch Settings and Connection Terminals

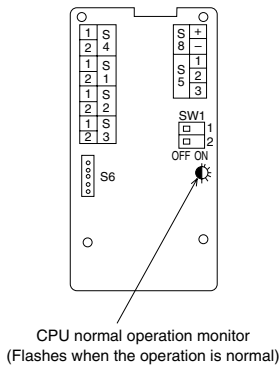

SW1-1	Selecting the operation mode	OFF	Operation mode 1 (Used with the exception of fan coil remote controller settings)			
		ON	Operation mode 2 (Used with fan coil remote controller settings)			
SW1-2	Selecting On/Off when power is restored after a power failure	OFF	Always Off			
		ON	Off if operation was in Off mode before power failure; On if operation was in On mode before power failure			
S1 S2 S3	SW1-1: OFF (Operation mode 1)			Instantaneous contact	Normal contact	
		S1 (1) - S2 (1)	OPEN	CLOSE		
		S1 (1) - S1 (2)	Pulse input On/Off switching		OPEN, Not activated CLOSE, Activated	
			S2 (2), S3		Not used	
			S1, S2 OPEN		Not activated	
			S1 (1) - S1 (2) CLOSE		On, airflow: L tap	
			S1 (1) - S2 (1) CLOSE		On, airflow: M tap	
			S1 (1) - S2 (2) CLOSE		On, airflow: H tap	
			S3 (With the remote controller only)		OPEN	Cooling
					CLOSE	Heating
S4	(1) - (2)	Voltage on (12 V DC), normal operation light output				
S5	(1) - (2)	Normal operation light output (power for light required)				
	(1) - (3)	Malfunction light output (power for light required)				
S6 connector		Connect with connector S21 on the PCB of the indoor unit				
S8	(+) - (-)	Relay 12 V DC power supply terminal (Field supplied parts)				

13.5 <KRP928BB2S> Interface Adaptor for DIII-NET

Safety Precautions

- Read these Safety Precautions carefully to ensure correct installation. This manual classifies precautions into WARNING and CAUTION.
 - WARNING** : Failure to follow WARNING is very likely to result in such grave consequences as death or serious injury.
 - CAUTION** : Failure to follow CAUTION may result in serious injury or property damage, and in certain circumstances, may result in a grave consequence.
- Be sure to follow all the precautions below ; they are all important for ensuring safety.

WARNING

- Installation should be left to the dealer or another qualified professional.**
Improper installation by yourself may cause malfunction, electrical shock, or fire.
- Install the set according to the instructions given in this manual.**
Incomplete or improper installation may cause malfunction, electrical shock, or fire.
- Be sure to use the standard attachments or the genuine parts.**
Use of other parts may cause malfunction, electrical shock, or fire.
- Disconnect power to the connected equipment before starting installation.**
Failure to do so may cause malfunction, electrical shock, or fire.
- A ground fault circuit interrupter / an earth leakage circuit breaker should be installed.**
If the breaker is not installed, electrical shock may occur.

CAUTION

- Do not install the set in a location where there is danger of exposure to inflammable gas.**
Gas accumulated around the unit at the worst may cause fire.
 - To prevent damage due to electrostatic discharge, touch your hand to a nearby metal object (doorknob, aluminum sash, etc.) to discharge static electricity from your body before touching this kit.**
Static electricity can damage this kit.
 - Lay this cable separately from other power cables to avoid external electrical noises.**
- After installation is complete, test the operation of the PCB set to check for problems, and explain how to use the set to the end-user.

1.Overview, Features and Compatible Models

This kit is the interface required when connecting the central controller and a Room Air Conditioner. Use of the central controller makes it possible to perform the following monitoring and operations. It is compatible with room air conditioners which have an HA connector S21.

- Run / stop for the central controller and wired remote controller, operating mode selection, and temperature can be set.
- The operating status, any errors, and the content of those errors can be monitored from the central controller and wired remote controller.
- Run / stop for the central controller and wireless remote controller, operating mode selection, and the temperature setting can be limited by the central controller.
- Zone control can be performed from the central controller.
- The unit can remember the operating status of the air conditioner before a power outage and then start operating in the same status when the power comes back on.
- Card keys, operating control panels, and other constant / instantaneous connection-compatible equipment can be connected.
- The Operating / error signals can be read.
- The indoor temperature can be monitored from the iTM / ITC.

Precaution

- When reading the Operating / error signals, a separate external power source (12 V DC) is needed.
- A separate timer power source (16 V DC) is needed when using the schedule timer independently, and not in conjunction with other central controllers.
- The range of temperatures that can be set from the central controller is 18°C to 32°C in cooling and 14°C to 28°C in heating.
- Fan operation cannot be selected from the central controller or wired remote controller.
- Group control (i.e., control of multiple indoor units with a single remote controller) is not available.
- Monitoring is not available of the thermo status, compressor operating status, indoor fan operating status, electric heater, or humidifier operating status.
- Forced thermo off, filter sign display and reset, fan direction and speed settings, air conditioning fee management, energy savings instructions, low-noise instructions, and demand instructions cannot be made.
- Since a stop due to a momentary power failure cannot be detected, automatic operating start may not be possible.

2.Component Parts

This kit includes the following components. Check to ensure that none of these are missing.

Parts	Q'ty	Parts	Q'ty
Kit assy PCB is in the housing.	1	Connection harness (about 1.6m)	1
		Mounting screws	3
		Binding band	6
		Installation manual	2

3.Names of Parts and Electric Wiring

<Wiring procedure>

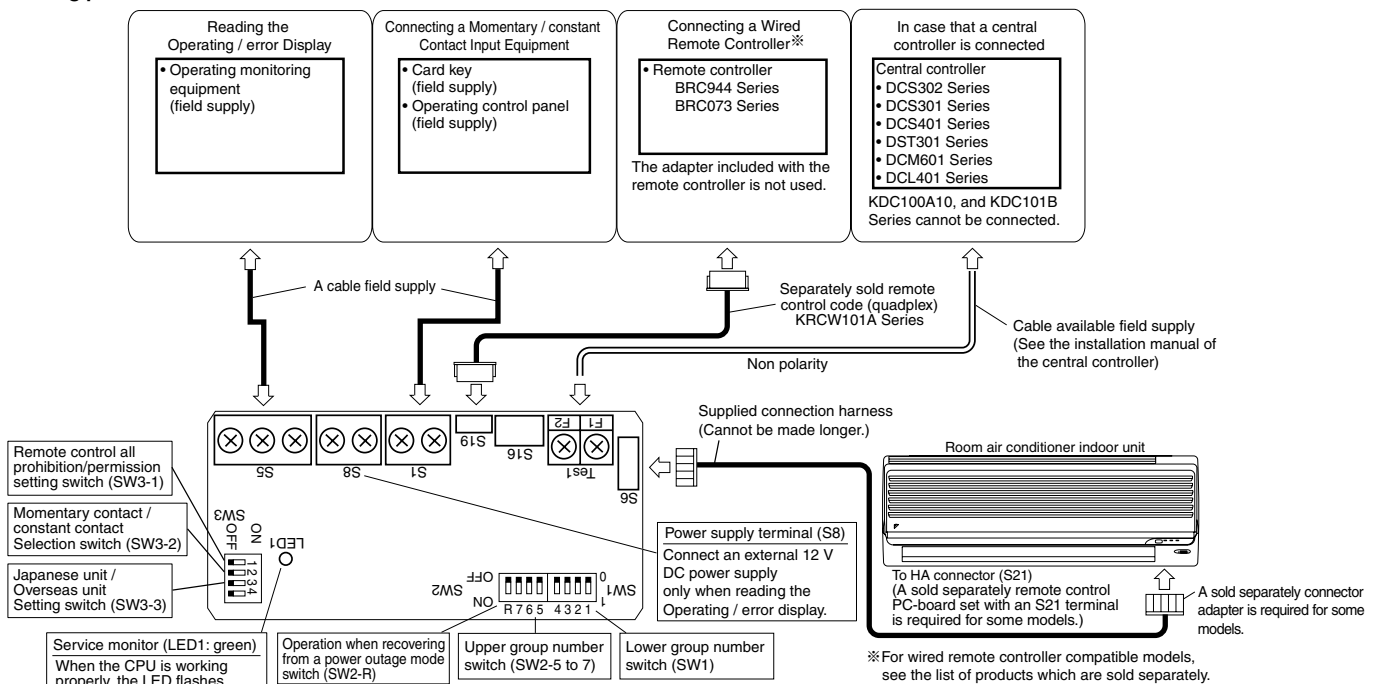

4. Switch Settings

NOTE Turn the power on after all the switches have been set. Settings made while the power is on are invalid.

Open the Kit's case and set the switches on the circuit board.

(1) For Overseas / Japanese unit setting (SW3-3)
Room air conditioners, different methods are used for setting the temperature in automatic mode, so this switch needs to be set.

Destination	SW3-3 setting	What Happens
Japan	OFF (Factory setting)	• "Automatic" operation is not available from the central controller. When using "automatic" operation using the wireless remote controller, the central controller displays automatic cooling (heating) and 25°C. Even if the temperature is changed, it will return to 25°C after a while.
Overseas	ON	• "Automatic" operation is available from the central controller.

(2) Group number settings (SW1 and SW2-5 to SW2-7)
Set these when using the central controller. (Set to the side.) Do not set more than one unit to the same number.
Use SW2-R for (3) Settings when recovering from a power outage.

However, these settings do not need to be made when using the schedule timer independently.
(The settings are needed when used in conjunction with another DCS Series central controller.)
In this case, the schedule timer performs an auto address after the power is turned on, so new group numbers are automatically set. Settings made using the switches will be overwritten.

Group NO. Settings table (Enlarged section SW1 and SW2 in "3. Names of Parts and Electrical Wiring")

Group NO. Upper settings SW2		Group NO. Lower settings SW1									
1		5		00		04		08		12	
2		6		01		05		09		13	
3		7		02		06		10		14	
4		8		03		07		11		15	

: Use with power failure recovery settings Set to the side : ON : OFF

NOTE also that a separate timer power source is needed when using the schedule timer independently.
Power source specs: 16 V DC, +10%, -15%, 200mA.

(3) Settings when recovering from a power outage (SW2-R)
This selects whether to restart operation when the power comes back on after a power outage occurred during operation. This setting is given priority in cases where the indoor unit has an auto start ON / OFF jumper. Note also that regardless of whether switch SW2-R is on or off, the operating mode (NOTE), set temperature, fan direction and speed settings, and remote control prohibition status are stored.

SW2-R setting	What Happens
OFF (Factory setting)	Stops after recovering from a power outage
ON	Stops if the unit was stopped before the power outage and runs if it was running.

(NOTE) The following settings apply to the models below.

Mode before power outage	Room air conditioner	COOLING	HEATING
Models with humid heating and dehumidifying functions.	Models with humid heating and dehumidifying functions.	DRY COOLING	HUMID HEATING
			HEATING
Models with dehumidifying function.	Models with dehumidifying function.		HEATING

(4) Contact input function settings (SW3-1 to SW3-2)
When using contact input (S1), choose one of the following functions.

S1 operating mode	SW3-1 setting	SW3-2 setting	What Happens	Control mode
Instantaneous contact input (factory setting)	OFF	OFF	The operating status of the air conditioner is reversed by an instantaneous input of 100 msec or more.	Last command priority
Constant contact input	OFF	ON	Contact - Open to close: air condition runs. Close to open: air conditioner is stopped (NOTE 1).	ON / OFF control is rejected (operate / stop / timer prohibition) (NOTE 2).
Remote control all prohibition/permission input	ON	Invalid	Contact - Open to close: air condition stops. Close to open: no change in operating status.	All remote controller actions are prohibited when the contact is closed. (NOTE 3)

NOTE1: Since central controller uses last command priority, the contact status and operating status of the air conditioner might not match sometimes.
Example: If the unit is run from the central controller while the air conditioner is stopped with an open contact, the contact will be open and the unit will be running.
NOTE2: Operating mode and fan direction and speed settings can be changed.
NOTE3: If the contact is closed while the ON timer is set, as the power ON timer function is still operating, the operation starts at the time specified by the timer. To prevent operation of the power ON timer, use of the (KRP413BB1S) remote control PC-board set is recommended. However, note that it cannot be used in tandem with the central controller.
If this product is connected to an air conditioner manufactured in or after 2011, when the contact is closed, the power ON timer may be cancelled depending on the combination with the model.

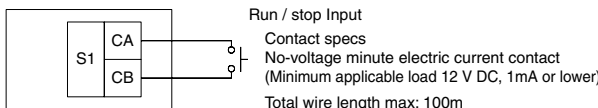

5. Control Codes

When using a central remote controller, the operating codes can be used to limit operation from wireless remote controllers. Three beeps for signal reception will be heard continuously when the wireless remote controller is operated while in central control.
○ : permitted; × : prohibited

S1 operating mode	Control mode	Control code	Operations from the remote controller					
			"Run" control from the central controller			"Stop" control from the central controller		
Instantaneous contact mode	ON / OFF control is rejected	0,1,3	×	×	○	×	×	○
	Only OFF control is accepted	2, 12-19	×	○	×	×	×	×
	Central priority	4	○	○	○	×	×	×
	Last command priority	5	○	○	○	×	×	×
	Timer operation is accepted by remote controller	6,7	○	○	○	○	○	○
		8	○*	○*	○*	×	×	×
Constant contact mode		2,10-19	×	×	×	×	×	×
		0,1,3,5-7	×	×	×	×	×	×
		4	×	×	×	×	×	×
		8	×	×	×	×	×	×
		9	○*	○*	○*	×	×	×
All remote controller actions are prohibited			×	×	×	×	×	×

*Only during timer operation
The remote controller permission / prohibition settings using the iTM / iTC are as follows.
○ : permitted; × : prohibited

S1 pin operating mode	iTM / iTC settings			Operations from the remote controller			
	Start / stop	Change operating mode	Change set temperature	Run / timer	Stop	Operating mode temperature	Fan direction and fan speed
Instantaneous contact mode	ON / OFF control is rejected	permitted	permitted/prohibited	×	×	○	
	Constant contact mode	prohibited	permitted/prohibited	×	×	×	
Instantaneous contact mode	Only OFF control is accepted	permitted	permitted/prohibited	×	×	○	
		prohibited	permitted/prohibited	×	○	×	
Constant contact mode	Last command priority	permitted	permitted/prohibited	×	×	○	
		prohibited	permitted/prohibited	×	○	×	
Instantaneous contact mode	Last command priority	permitted	permitted/prohibited	×	×	○	
		prohibited	permitted/prohibited	×	×	×	
Constant contact mode	All remote controller actions are prohibited	permitted	permitted/prohibited	×	×	×	
		prohibited	permitted/prohibited	×	×	×	
Does not affect settings				×	×	×	×

6. Read Operating / Error Display Signal

The Operating / error signals can be read from the contact output (S5).
Output specs
M1: Turn MR 1 ON when the air conditioner is running.
M2: Turn MR 2 when a communication error has occurred between the KRP928BB2S and the air conditioner, or MR 1 is ON and the unit has stopped after an error.
MR 2 is not turned ON during a warning.

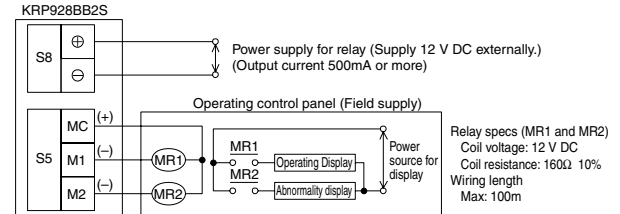

7. Combining Equipment

The central controller can be combined with the following devices.

	Central Remote Controller	ON / OFF controller	Schedule timer	D-BIPS	Contact input	Wired Remote Controller	Wireless Remote Controller
Central Remote Controller	○	○	○	○	○	○	○
ON / OFF controller	○	○	○	○	○	○	○
Schedule timer	○	○	×	×	○	○	○
D-BIPS	○	○	×	×	○	○	○
Contact input	○	○	○	○	×	○	○
Wired Remote Controller	○	○	○	○	○	×	×
Wireless Remote Controller	○	○	○	○	○	○	×

Connection to Remote Control PC-board

1. Removal of upper HA casing

① Insert a flat-blade screwdriver into the groove between the upper and lower casings.

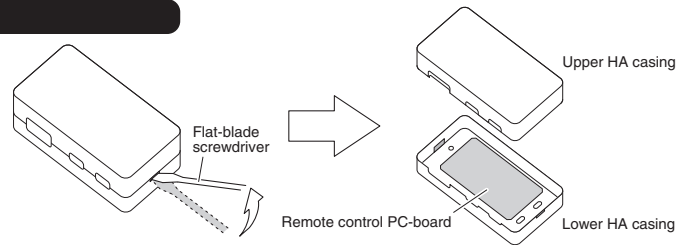

② Lift the handle of the screwdriver upward.

2. Securing of lower HA casing

Mount and secure the lower HA casing directly on the wall with the provided screws inserted into the screw holes (a round hole and two ellipse holes) of the casing.

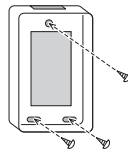

NOTE Mount the HA casing in a direction where the wiring through-holes will be hidden in order to prevent infants from putting their fingers into the HA casing and the LED light on the internal PC board from leaking outside.

3. Connection of wiring

Connect the wiring to the connector terminals.

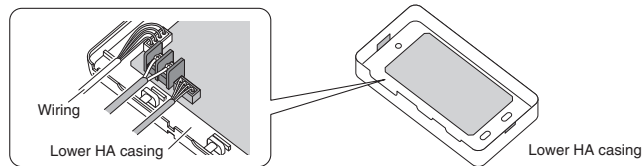

4. Fixation of wiring

① Insert the provided binding band under the pillar of the HA casing and secure the covers of the wiring with the binding band.

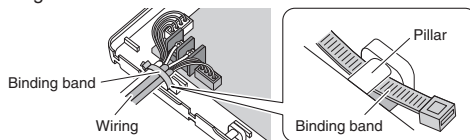

② Insert the second binding band into the groove on the side of the HA casing and fix the wiring securely so that the wiring will not be disconnected.

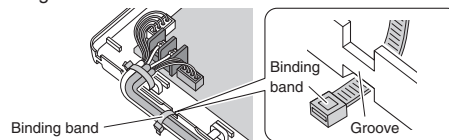

A large number of wires

Make a slit with an appropriate tool, such as a cutter knife, on the thin part of the upper HA casing along the frame. Then cut the part with an appropriate tool, such as a pair of nippers.

(NOTE) Cut off only the thin part required for wiring.

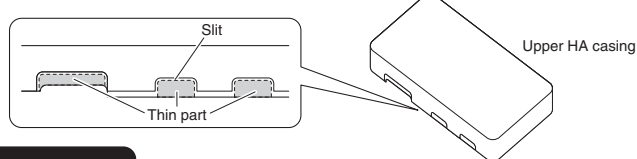

5. Finishing

Mount the upper HA casing to the original position.

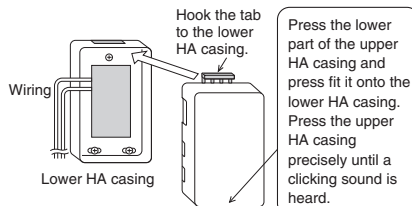

Information

When the contact input device (such as card keys) and central controller are used in tandem:

Even when the operating mode of the S1 pin is set to prohibit all remote controller actions, run/stop operation from the central controller is possible. The operation also starts when the power ON timer of the indoor unit is up while all remote controller actions are prohibited. (*) In this case, stop the operation from the central controller. For the compatible models of the (KRC944 series) remote controller, the operation can be prohibited by using the remote controller in tandem with the central controller. *If this product is connected to an air conditioner manufactured in or after 2011, when the contact is closed, the power ON timer may be cancelled depending on the combination with the model.

13.6 <KRP980B2> Interface Adaptor for Residential Air Conditioner

Safety Considerations

- Read these **Safety Considerations** carefully to ensure correct installation.
- This manual classifies the precautions into **WARNING** and **CAUTION**. Be sure to follow all the precautions below: they are all important for ensuring safety.

⚠ WARNING : Failure to follow any of **WARNING** is likely to result in such grave consequences as death or serious injury.

⚠ CAUTION : Failure to follow any of **CAUTION** may in some cases result in grave consequences.

⚠ WARNING

- **Installation shall be left to the authorized dealer or another trained professional.** Improper installation may cause water leakage, electrical shock, fire, or equipment damage.
- **Be sure to use the supplied or exact specified installation parts.** Use of other parts may cause the unit to come to fall, water leakage, electrical shock, fire or equipment damage.
- **Be sure to switch off the unit before touching any electrical parts.**
- **Be sure to install a ground fault circuit interrupter.** Failure to install a ground fault circuit interrupter may result in electrical shock, fire or personal injury.

⚠ CAUTION

- **Do not install the air conditioner where gas leakage would be exposed to open flames.** If the gas leaks and builds up around the unit, it may catch fire.
- **Touch a nearby metal object (doorknob, aluminium sash, etc.) to discharge static electricity from your body before touching this set.**
(Static electricity from your body can damage this set.)
- **Lay the cable separately from other power cables.**
(Poor wiring may cause external electrical noise.)
- **After completing installation, test the unit to check for installation errors.** Give the user adequate instructions concerning the use and cleaning of the unit according to the Operation Manual.

Outline / Features

This set is an interface that connects a central control device to a room air conditioner and allows you to perform the following operations, or monitoring, in combination with the central control device using KRP413AB1S or KRP928BB2S (sold separately).

- Starting and stopping the air conditioner, and setting the mode and temperature, through the central control device or the wired remote controller. (64°F to 90°F (18°C to 32°C) in COOL operation, 57°F to 82°F (14°C to 28°C) in HEAT operation, none in FAN operation)
- Monitoring the operating conditions, occurrence of errors, and contents of errors of the air conditioner through the central control device or the wired remote controller.
- Restricting the operation with a wireless remote controller found near the air conditioner, such as starting and stopping operation, changing the mode, or setting the temperature, through the use of the central control device, coin timer, or card key.
- Zone control through the central control device.
- Restoring the operating conditions of the air conditioner to the previous conditions at the time of power recovery in case of power outage.

The set does not support the following functions.

- Group control (i.e., the control of multiple indoor units through a single remote controller)
- Monitoring of the following items: Indoor temperature and operating conditions of thermo, compressor, indoor fan, electric heater, and humidifier
- Control of the following items: Forced thermo OFF, filter sign display and reset, airflow direction, airflow rate setting, and air-conditioner charge management
- Energy-saving command, low-noise command, and demand command

Components

This set includes the following components. Please confirm them.

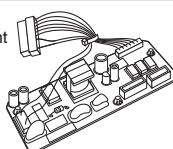
Component	Quantity	Component	Quantity
Main component 	1	Installation Manual	1

Installation Procedure

Installation Position

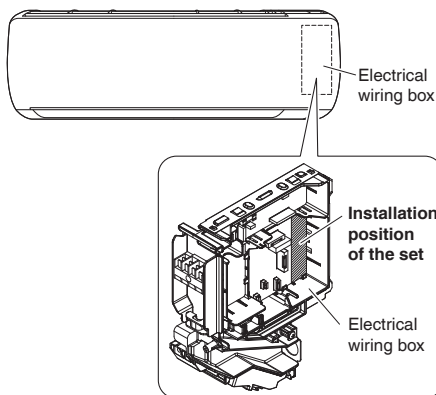

Wiring Outline

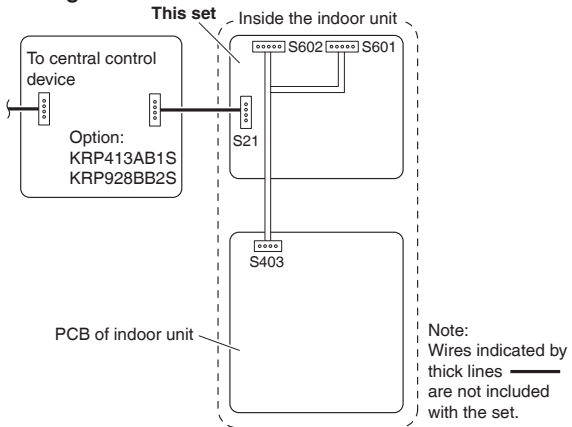

Removal and Installation of Front Panel

• Removal method

- 1) Place your fingers in the indentations on the main unit (one each on the left and right sides), and open the panel until it stops.
- 2) Continue to open the front panel further while sliding the panel to the left and pulling it toward yourself in order to disengage the rotating shaft on the left side.
To disengage the rotating shaft on the right side, slide the panel to the right while pulling it toward yourself.

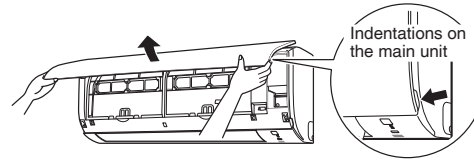

• Installation method

- Align the rotating shaft of the front panel with the grooves, and push all the way in. Then close slowly. Push both the sides and the center of the lower surface of the panel firmly.

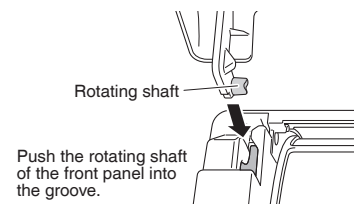

Removal and Installation of Front Grille

• Removal method

- 1) Remove front panel.
- 2) Remove the air filter and streamer unit (only for models with a streamer unit).
- 3) Remove the screws (3) from the front grille.
- 4) Disengage 3 hooks (the location can be identified by ○○○ mark) at the top of the grill.

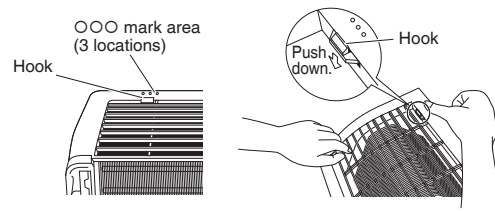

< When there is no work space because the unit is close to ceiling >

- Disengage the flap (horizontal blade), and pull the lower part of the front grille toward yourself to remove it. If it is difficult to remove, place both hands under the center of the front grille, and while pushing up, pull it toward yourself.

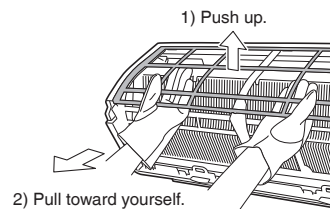

CAUTION
Be sure to wear protection gloves.

• Installation method

- 1) Install the front grille and firmly engage the upper hooks (3 locations).
- 2) Insert 3 screws of the front grille.
- 3) Install the air filter then mount the front panel.

Removal of Electrical Wiring Cover

1. Remove the front panel and the front grille.
(Refer to the front page for the removal of each part in detail.)
2. Remove the electrical wiring cover.

⚠ WARNING

- Be sure to turn OFF the power at the time of installation work.
Touching any electric parts with the power turned ON may cause electric shock.

Electrical wiring box
If there is workspace on the right-hand side of the indoor unit, the installation work can be conducted without removing the electrical wiring box.

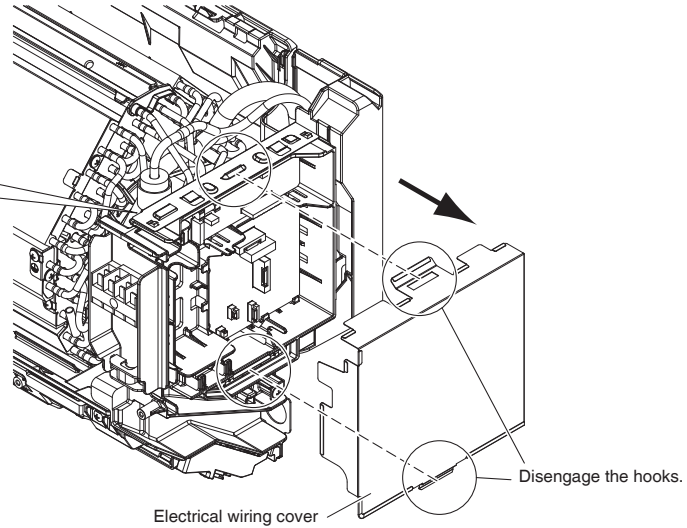

Removal of Electrical Wiring Box

If there is workspace on the right-hand side of the indoor unit, the installation work can be conducted without removing the electrical wiring box.
Connect HA without removing the electrical wiring box, if possible.

1. Disconnect the contact wire.
2. Disconnect the fan motor connector (S200) and swing motor connector (S6, S11).
(Some models may not have S11 connector.)
3. Disconnect the thermistor and ground wire from the heat exchanger (two screws).
(Some models may not have ground wire.)
4. Remove the mounting screw of the electrical wiring box (one screw).

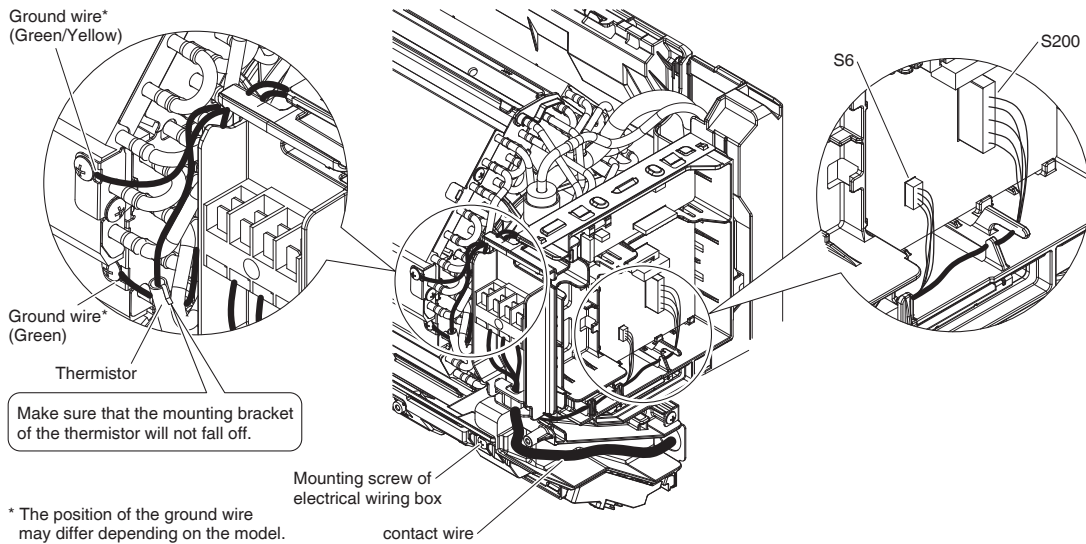

* The position of the ground wire may differ depending on the model.

Connecting HA PCB

1. Install the HA PCB (this set). (See Fig. 1)

- 1) Install the HA PCB (this set) to the electrical wiring box.
- 2) Insert the connector of the HA PCB (this set) to the connector (S403) on the electrical wiring box.

2. Connect the HA connection cord. (See Fig. 1 and 2)

- 1) Insert the HA connection cord into the HA connector, "S21" (white) on the HA PCB (this set).
- 2) Route the HA connection cord as shown in Fig. 2.

Fig. 1 Connection points of the HA PCB

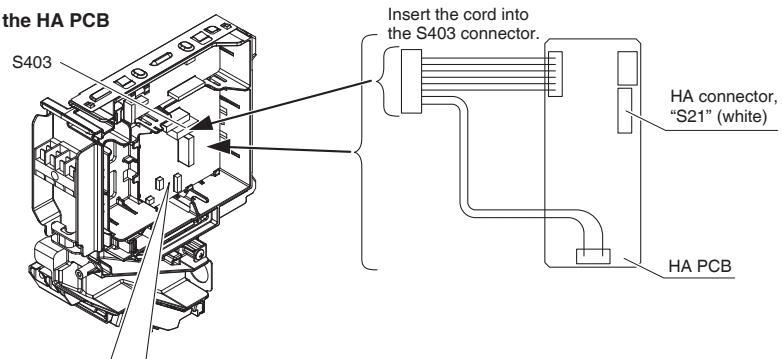

Installing HA PCB on the electrical wiring box

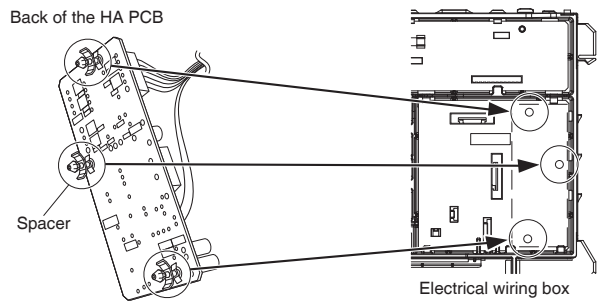
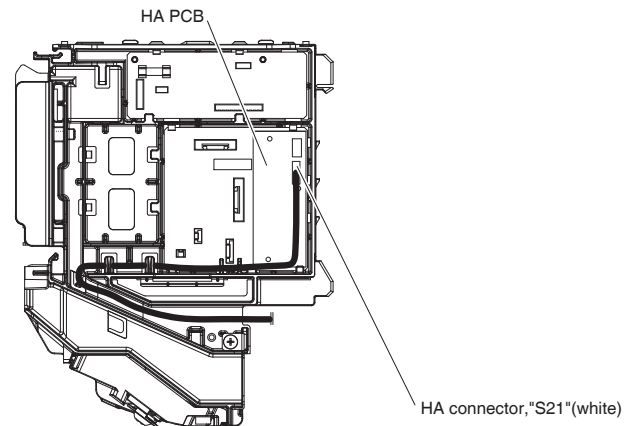

Fig. 2 Routing HA connection cord



13.7 <DCS302C71> Central Remote Controller Installation Manual

Please read these "SAFETY CONSIDERATIONS" carefully before installing air conditioning equipment and be sure to install it correctly. After completing the installation, make sure that the unit operates properly during the start-up operation. Please instruct the customer on how to operate the unit and keep it maintained. Also, inform customers that they should store this installation manual along with the operation manual for future reference. This air conditioner comes under the term "appliances not accessible to the general public".

Meaning of warning, caution and note symbols.

- ⚠ WARNING** Indication a potentially hazardous situation which, if not avoided, could result in death or serious injury.
⚠ CAUTION Indication a potentially hazardous situation which, if not avoided, may result in minor or moderate injury. It may also be used to alert against unsafe practices.
⚠ NOTE Indication situation that may result in equipment or property-damage-only accidents.

⚠ WARNING

Ask your dealer or qualified personnel to carry out installation work. Do not try to install the machine by yourself. Improper installation may result in water leakage, electric shocks or fire.

Perform installation work in accordance with this installation manual. Improper installation may result in water leakage, electric shocks or fire.

Be sure to use only the specified accessories and parts for installation work. Failure to use the specified parts may result in water leakage, electric shocks, fire or the unit falling.

Carry out the specified installation work after taking into account strong winds, typhoons or earthquakes. Improper installation work may result in the equipment falling and causing accidents.

Make sure that a separate power supply circuit is provided for this unit and that all electrical work is carried out by qualified personnel according to local laws and regulations and this installation manual. An insufficient power supply capacity or improper electrical construction may lead to electric shocks or fire.

Make sure that all wiring is secured, the specified wires and used, and no external forces act on the terminal connections or wires. Improper connections or installation may result in fire.

When wiring the power supply and connecting the remote controller wiring and transmission wiring, position the wires so that the electric parts box lid can be securely fastened. Improper positioning of the electric parts box lid may result in electric shocks, fire or the terminals overheating.

Before touching electrical parts, turn off the unit.

Ground the air conditioner. Do not connect the ground wire to gas or water pipes, lightning rod or a telephone ground wire. Incomplete grounding may result in electric shocks.

When installing or relocating the system, be sure to keep the refrigerant circuit free from substances other than the specified refrigerant (R410A), such as air.

Do not reconstruct or change the settings of the protection devices. If the pressure switch, thermal switch, or other protection device is shorted and operated forcibly, or parts other than those specified by Daikin are used, fire or explosion may result.

Do not touch the switch with wet fingers. Touching a switch with wet fingers can cause electric shock.

Install an leak circuit breaker, as required. If a leak circuit breaker is not installed, electric shock may result.

Do not install the air conditioner or the remote controller in the following locations:

- where a mineral oil mist or an oil spray or vapor is produced, for example in a kitchen
Plastic parts may deteriorate and fall off or result in water leakage.
- where corrosive gas, such as sulfurous acid gas, is produced
Corroding copper pipes or soldered parts may result in refrigerant leakage.
- near machinery emitting electromagnetic waves
Electromagnetic waves may disturb the operation of the control system and result in a malfunction of the equipment.
- where flammable gases may leak, where there are carbon fiber or ignitable dust suspensions in the air, or where volatile flammables such as thinner or gasoline are handled.
Operating the unit in such conditions may result in fire.

⚠ CAUTION

Be very careful about product transportation.

Safely dispose of the packing materials. Packing materials, such as nails and other metal or wooden parts, may cause stabs or other injuries. Tear apart and throw away plastic packaging bags so that children will not play with them. If children play with a plastic bag which was not torn apart, they face the risk of suffocation.

Do not turn off the power immediately after stopping operation. Always wait at least five minutes before turning off the power. Otherwise, water leakage and trouble may occur.

⚠ NOTE

Install the indoor and outdoor units, power supply wiring and connecting wires at least 3.5ft. away from televisions or radios in order to prevent image interference or noise. (Depending on the radio waves, a distance of 3.5ft. may not be sufficient enough to eliminate the noise.)

Remote controller (wireless kit) transmitting distance can result shorter than expected in rooms with electronic fluorescent lamps.(inverter or rapid start types) Install the indoor unit as far away from fluorescent lamps as possible.

This unit is a class A product. In a domestic environment this product may cause radio interference in which case the user may be required to take adequate measures.

Dismantling of the unit, treatment of the refrigerant, oil and eventual other parts, should be done in accordance with the relevant local and national regulations.

1 COMPONENTS

Check the following components are included in this optional accessory before installation.

Installation screw (M4 x 16)	4
Operation manual	1
Installation manual	1
Installation table	1

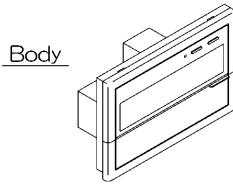

When using this optional accessory an electric parts box of KJB311A is required. For installation, a steel electric parts box to be embedded is mandatory.

2 SYSTEM CONFIGURATION

With the central remote controller, unified operation/stop is possible with up to a maximum 64 groups of indoor units. When using 2 central remote controllers, unified operation is possible with up to a maximum 128 groups. With this optional accessory, setting of control modes including operation, stop, operation controlled by timer, and ON/OFF control possible/impossible by remote controller can be set individually by zones while it enables to control and display the operation state such as set temperature. It can be connected with the external key system, host computer monitor panel, etc., through forced OFF input (no-voltage normally open contactor). A zone is a one or more groups together. In general, the same settings are used throughout a zone.

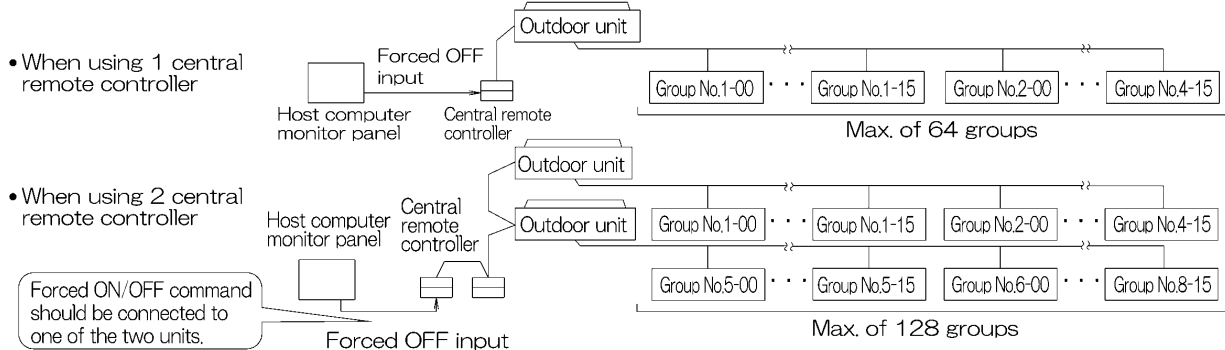

The central remote controller and the separately sold remote control adapter circuit board or group remote control adapter cannot be used together. See the D-BACS design guide for details.

3 INSTALLATION

(1) Open the upper part of remote controller. Insert a ⊖ screwdriver (2 locations) into the recess between the upper part and the lower part of remote controller and twist the screwdriver lightly.

PC board is attached with both the upper and lower part of remote controller. Do not damage the board with the screwdriver.

(2) Open the upper part of remote controller and install the Electric parts box with the attached installation screws (M4 x 16).

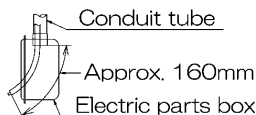

Installation screws (4)

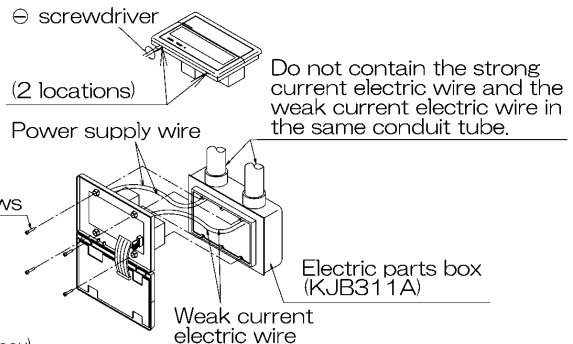

NOTE) Suitable length of the electric wire is about 160mm. (from electric parts box) If it is difficult to contain a long wiring, strip the sheathed part of the wiring.

4 INITIAL SETTING

Setting (1) through (3) are initialized when power is turned ON, therefore complete settings BEFORE activating the power. (The positions of connectors and switches used for settings in this section are shown in Fig. 1)

- (1) Connector for setting master controller (X1A) (Provided with connector at factory set)
- When using only 1 central remote controller, do not disconnect the connector for setting master controller. (Use the unit with the connector in the state in which it was delivered.)
 - When using multiple central remote controllers, or using the central remote controller in conjunction with the optional controllers for centralized control, makes settings as indicated in the below table.

Pattern of connection of optional controllers for centralized control			Connector for setting master controller (X1A) Setting, Removed		
Central remote controller	Unified ON/OFF controller	Schedule timer	Central remote controller	Unified ON/OFF controller	Schedule timer
1 to 4	1 to 16	1	Set one to "Used" and all the rest to "Not used"	Set all to "Not used"	"Not used"
		1			"Not used"

(Remove all the connectors for the central remote controller, the on/off controller, and the schedule timer when using the unit together with the Ve-UP controller, the master station II, the DMS interface, the payment management unit, or the parallel interface station.)

- (2) Address setting
Two central remote controllers can be used as shown in **2 SYSTEM CONFIGURATION**, to control anywhere up to a max. 128 groups of indoor units. In this case, group address must be set. This is done with the switch for setting each address (SS3).

SS3 setting	Indoor unit address	SS3 setting	Indoor unit address
SETTING EACH ADDRESS 5-00 ~ 8-15	To control indoor units from group Nos. 1-00 through 4-15	SETTING EACH ADDRESS 5-00 ~ 8-15	To control indoor units from group Nos. 5-00 through 8-15

- (3) MAIN/SUB changeover switch setting
With two central remote controllers, centralized control (indoor units) is possible from different locations. In this kind of set-up, it is necessary to set the MAIN/SUB changeover switch.

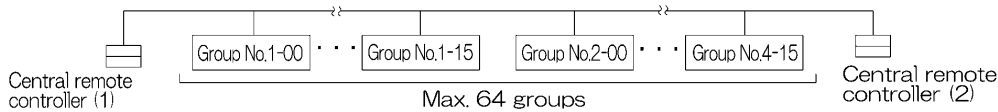

One of the two central remote controllers (1) . (2) is set to "MAIN" while the other is set to "SUB".

- (4) Setting of the sequential operation function
The central remote controller is equipped with a sequential operation function that sequentially turns indoor units on in 2-second intervals during unified operation. (Sequential operation is factory set to "ON.") To switch sequential operation ON or OFF, set as follows.

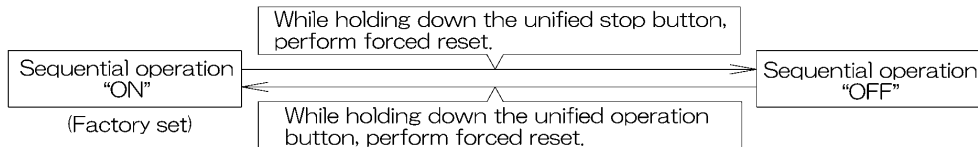

NOTE: The sequential operation function is designed to reduce the load on the power supply equipment, but does not guarantee that compressors will not be started simultaneously. You cannot therefore count on a capacity reduction effect by power supply equipment breaker selection.

- (5) Forced reset switch
When changing the setting of the connector for setting master controller, etc., you can reset simply by setting it to the reset side once and returning to the normal side, without turning the power OFF. (For normal operation, set the switch to the normal side.)

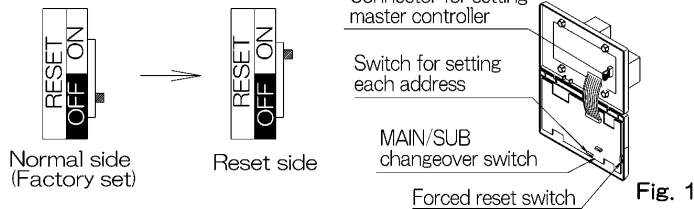
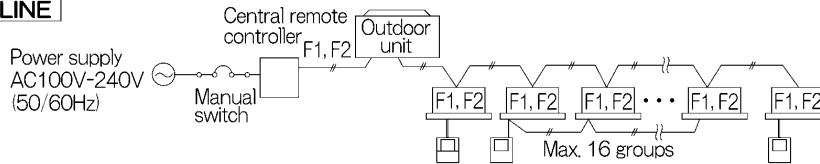

Fig. 1

5 ELECTRIC WIRING

WIRING OUTLINE



WIRING TO THE INDOOR UNIT AND OUTDOOR UNIT

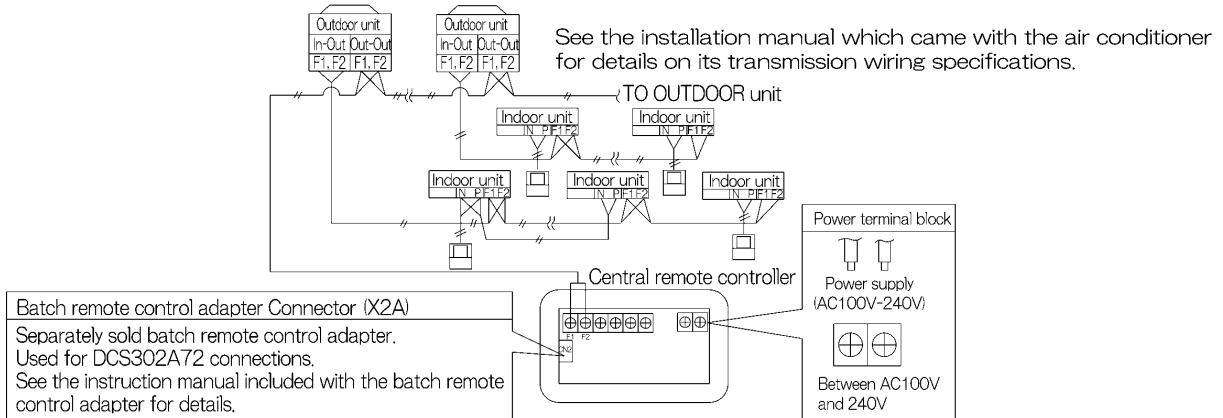

Wiring specifications

Power supply wiring	2mm ²
Transmission wiring for control	0.75 – 1.25 mm ² sheathed vinyl cord or cable (balanced type) – maximum length 1000 m (total overall wiring length 2000 m)
Manual switch	10A or 15A

Wire the indoor units to the outdoor units and between all power, indoor units, and remote controllers. See the instruction manual included with the indoor and outdoor units for details.

CONTROL TERMINAL STRIP

*1 For connecting Indoor unit (F1, F2)

*2 Forced OFF input (T1, T2)

None of the indoor units connected to the forced OFF input contact (non-voltage contact with minimal current) will operate when it is shut off.
 Use only contactors which guarantee the minimum applicable load DC 16V, 10mA.

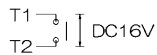

NOTE) Use instantaneous contactor of over 200m sec. energizing time, when necessary.

*3 For schedule timer (D1, D2)

Power can be supplied to the schedule timer (DST301B61) separately sold. For details, refer to the installation manual of the schedule timer.

Wire *2 and *3 only when necessary.

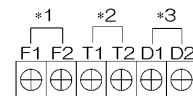

(NOTE)

Do not connect the power supply wiring (100 to 240V) to the control terminal strip. If connected by mistake, it may damage or burn electrical parts of optional controllers for centralized control and indoor unit. It may result in serious danger. Be sure to check wirings before turning the power ON.

6 SETTING GROUP NO. FOR CENTRALIZED CONTROL

Set the group number of each group of the indoor unit from the remote controller. (In case of no remote controller, also connect the remote controller and set the group No. Then, remove the remote controller.)

- (1) Turn ON the power of the indoor unit and central remote controller.

(Unless the power is ON, no setting can be made.)

Check that the installation and electrical wiring are correct before turning the power supply ON.

(When the power supply is turned ON, all LCD appear once and the unit may not accept the operation for about one minute with the display of “88”.)

- (2) While in the normal mode, hold down the “” button for a minimum of 4 seconds.

The remote controller will enter the FIELD SET MODE.

- (3) Select the MODE No. “00” with the “” button.

- (4) Use the “” button to select the group No. for each group.
(Group numbers increase in the order of 1-00,1-01,...1-15, 2-00,...8-15.)

- (5) Press “” to set the selected group No.

- (6) Press “” to return to the NORMAL MODE.

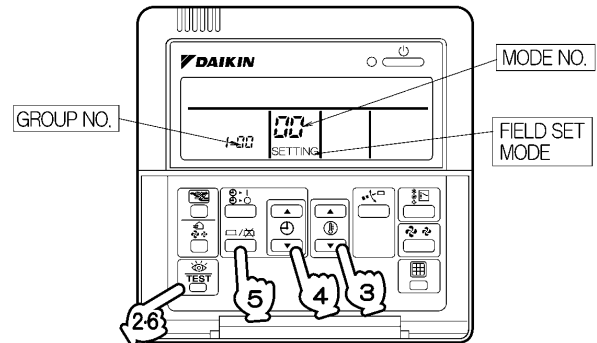

- NOTES) ● For simplified remote controller, see the installation table.
● See the instruction manuals which came with the Ventiair and adapters (i.e., multi-purpose adapters) for details on their Group No. settings.

NOTICE Enter the group No. and installation place of the indoor unit into the installation table in the operation manual. Be sure to keep the operation manual for maintenance.





7 TEST OPERATION (Perform a test operation in the individual screen before registering zones.)

Before starting test operation, check that the power is supplied to the indoor and outdoor units, and central remote controller.

- (1) Select the display “INDIVIDUALLY”

Press “” button to display “INDIVIDUALLY”

- (2) Select the group to be tested.

Select the group No. with “” “” “” “” button.

- (3) Press “” button to select the test operation mode.

“TEST” is displayed.

“” is displayed on the remote controller.

- (4) Press “” button within 10 seconds after entering into the test operation mode.

Operation the unit for 30 minutes.

When pressing the “” button, the unit stops operating.

If the operation lamp flashes, it indicates a malfunction.

Call the group of flashing display, confirm malfunction code, and check the source of malfunction.

(The operation manual lists all error codes, so refer to it.)

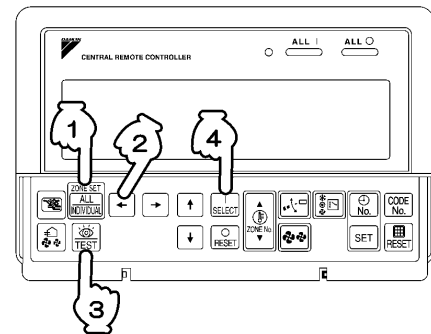

- NOTES ● For test operation, refer to the installation manual of the outdoor unit.
● After turning the power supply ON, if the unit does not accept operation for two minutes or more with the display of “88”, check the following points.
● Check that setting of the connector for setting master controller is correct.
● Check that the group No. for centralized control has been set.

13.8 <DCS302C71> Central Remote Controller Operation Manual

BEFORE USE

■ GENERAL DESCRIPTION OF SYSTEM

This central remote controller can monitor and control up to 64 indoor unit groups. Using two central remote controllers allows monitoring and controlling of up to 128 indoor unit groups.

Main Functions

1. Batch starting and stopping of indoor units connected to the central remote controller.
2. Handling of operation settings such as start/stop, timer operation, remote controller prohibition/permission, etc., and operation status settings such as temperature.
3. Operation status monitoring of operation mode, set temperature, etc.
4. Can be connected to an external central monitor panel and key system using the forced stop input (non-voltage a connector).

- When using 1 central remote controller

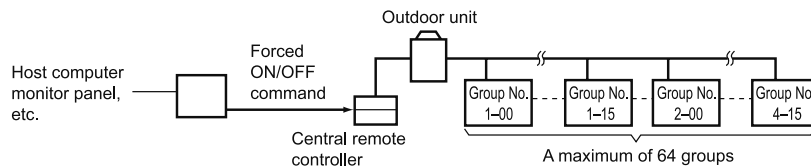

- When using 2 central remote controllers

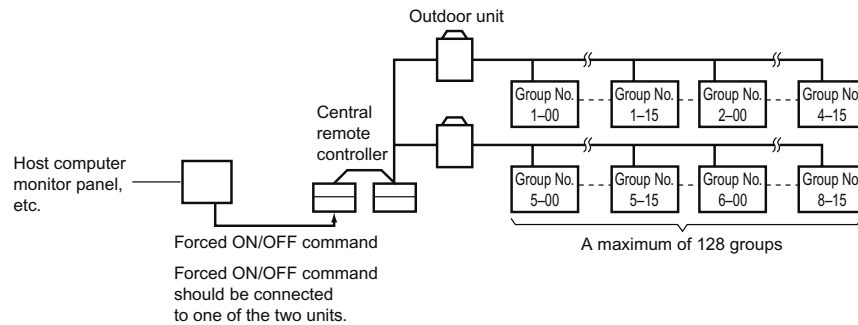

(The central remote controller and the separately sold remote control adapter circuit board or group remote control adapter cannot be used together.)

* GROUP OF INDOOR UNIT refers to the below.

1. A single indoor unit without remote controller

1. A single indoor unit without remote controller

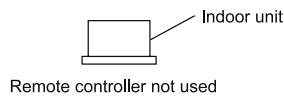

2. A single indoor unit controlled by one or two remote controllers

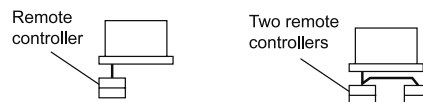

3. Maximum of 16 indoor units, group-controlled by one or two remote controllers

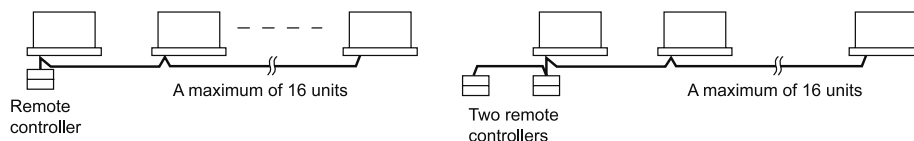

* Zone control from the central remote controller

Zone control is available from the central remote controller. With it, it is possible to make unified settings for multiple groups, so setting operations are greatly simplified.

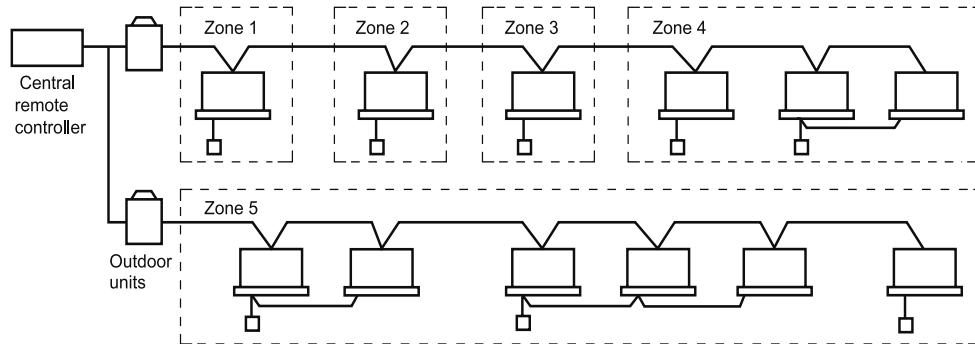

- Any setting you make within a given zone will apply to all groups in the said zone.
- A maximum of 64 zones can be set from a single central remote controller. (Each zone contains a maximum of 64 groups.)
- Zones can be set randomly from the central remote controller.

SAFETY CONSIDERATIONS

Please read these "SAFETY CONSIDERATIONS" carefully before installing air conditioning equipment and be sure to install it correctly. After completing the installation, make sure that the unit operates properly during the start-up operation. Please instruct the customer on how to operate the unit and keep it maintained. Also, inform customers that they should store this installation manual along with the operation manual for future reference. This air conditioner comes under the term "appliances not accessible to the general public".

Meaning of danger, warning, caution and note symbols.

⚠ DANGER Indicates an imminently hazardous situation which, if not avoided, will result in death or serious injury.

⚠ WARNING Indicates a potentially hazardous situation which, if not avoided, could result in death or serious injury.

⚠ CAUTION Indicates a potentially hazardous situation which, if not avoided, may result in minor or moderate injury. It may also be used to alert against unsafe practices.

⚠ NOTE..... Indicates situation that may result in equipment or property-damage-only accidents.

Keep these warning sheets handy so that you can refer to them if needed.

Also, if this equipment is transferred to a new user, make sure to hand over this operation manual to the new user.

⚠ DANGER

- Any abnormalities in the operation of the air conditioner such as smoke or fire could result in severe injury or death. Turn off the power and contact your dealer immediately for instructions.
- **Do not install the unit in an area where flammable materials are present due to risk of explosion resulting in serious injury or death.**
- **Safely dispose of the packing materials.** Packing materials, such as nails and other metal or wooden parts, may cause stabs or other injuries. Tear apart and throw away plastic packaging bags so that children will not play with them. Children playing with plastic bags face the danger of death due to suffocation.

⚠ WARNING

- **Ask your dealer for installation of the air conditioner.** Incomplete installation performed by yourself may result in a water leakage, electric shock, and fire.
- **Ask your dealer for improvement, repair, and maintenance.** Incomplete improvement, repair, and maintenance may result in a water leakage, electric shock, and fire.
- **Improper installation or attachment of equipment or accessories could result in electric shock, short-circuit, leaks, fire or other damage to the equipment. Be sure only to use accessories made by Daikin which are specifically designed for use with the equipment and have them installed by a professional.**
- **Ask your dealer to move and reinstall the air conditioner or the remote controller.** Incomplete installation may result in a water leakage, electric shock, and fire.
- **Never let the indoor unit or the remote controller get wet.** It may cause an electric shock or a fire.

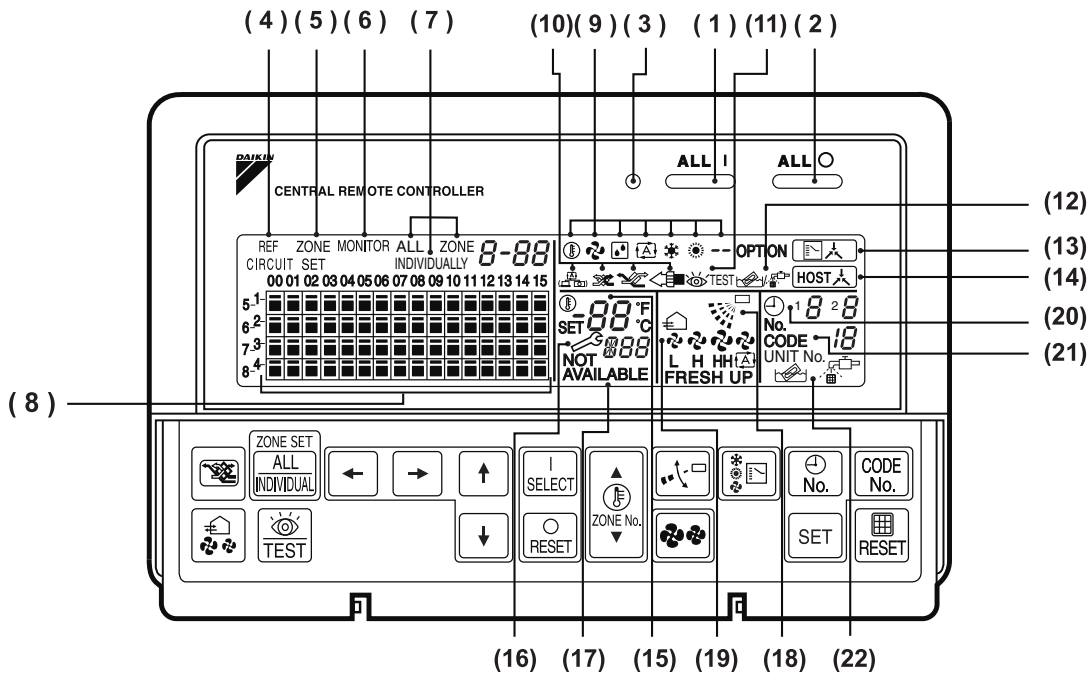

Fig. 1

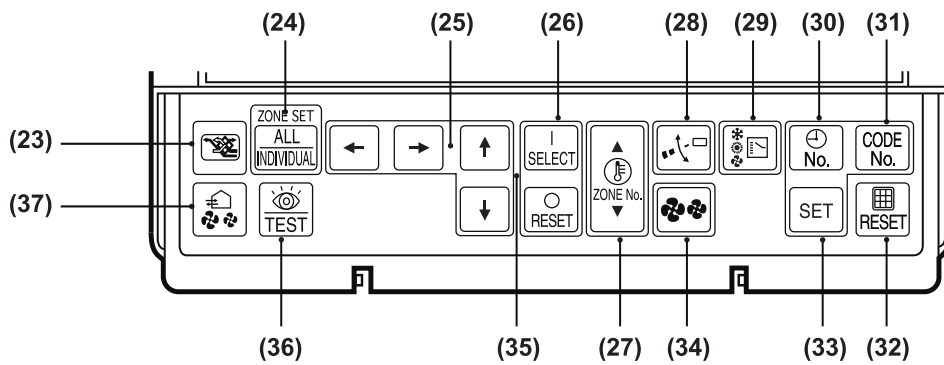

Fig. 2

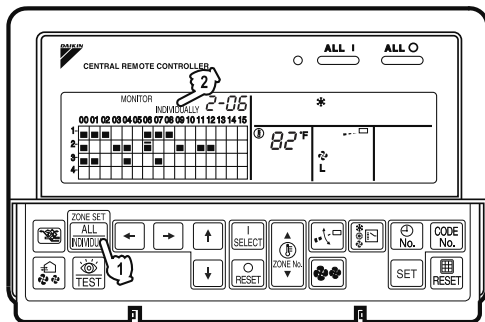

Fig. 3

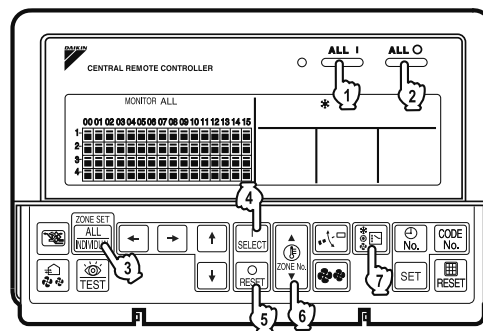

Fig. 4

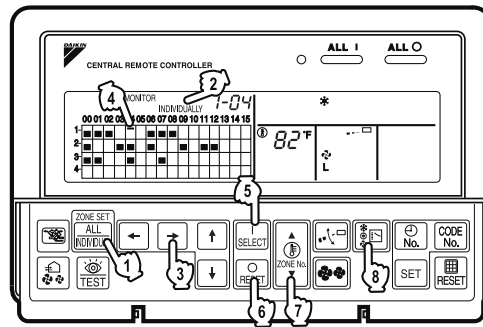

Fig. 5

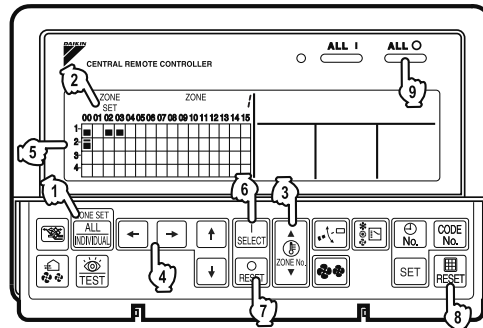

Fig. 6

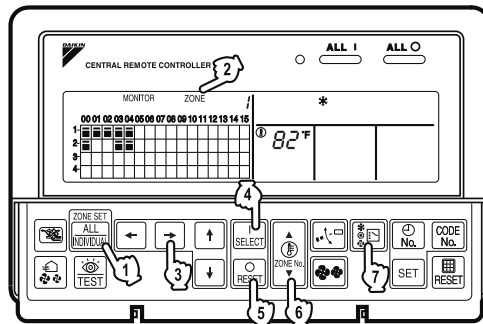

Fig. 7

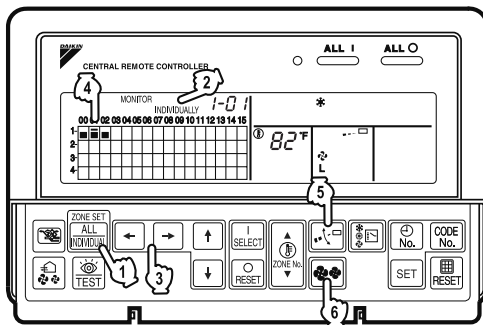

Fig. 8

- **Never use flammable spray such as hair spray, lacquer or paint near the unit.**
It may cause a fire.
- **Do not allow children to play on or around the unit as they could be injured.**
- **Never replace a fuse with that of wrong ampere ratings or other wires when a fuse blows out.**
Use of wire or copper wire may cause the unit to break down or cause a fire.
- **Never inspect or service the unit by yourself.**
Ask a qualified service person to perform this work.
- **Cut off all electric waves before maintenance.**
- **Do not wash the air conditioner or the remote controller with excessive water.**
Electric shock or fire may result.
- **Do not touch the switch with wet fingers.**
Touching a switch with wet fingers can cause electric shock.
- **Never touch the internal parts of the controller.**
Do not remove the front panel because some parts inside are dangerous to touch. In addition, some parts may be damaged by touching. For checking and adjusting internal parts, contact your dealer.
- **Check the unit stand for damage on a continuous basis, especially if it had been in use for a long time.**
If left in a damaged condition the unit may fall and cause injury.
- **Placing a flower vase or other containers with water or other liquids on the unit could result in a shock hazard or fire if a spill occurs.**

CAUTION

- **Avoid placing the controller in a spot splashed with water.**
Water coming inside the machine may cause an electric leak or may damage the internal electronic parts.

- **Do not operate the air conditioner when using a room fumigation - type insecticide.**
Failure to observe could cause the chemicals to become deposited in the unit, which could endanger the health of those who are hypersensitive to chemicals.
- **Do not turn off the power immediately after stopping operation.**
Always wait at least five minutes before turning off the power. Otherwise, water leakage and trouble may occur.
- **The appliance is not intended for use by young children or infirm persons without supervision.**
- **The remote controller should be installed in such a way that children cannot play with it.**

NOTE

- **Never press the button of the remote controller with a hard, pointed object.**
The remote controller may be damaged.
- **Never pull or twist the electric wire of the remote controller.**
It may cause the unit to malfunction.
- **Do not place the controller exposed to direct sunlight.**
The LCD display may get discolored, failing to display the data.
- **Do not wipe the controller operation panel with benzene, thinner, chemical dustcloth, etc.**
The panel may get discolored or the coating peeled off. If it is heavily dirty, soak a cloth in water-diluted neutral detergent, squeeze it well and wipe the panel clean. And wipe it with another dry cloth.
- **Dismantling of the unit, treatment of the refrigerant, oil and eventual other parts, should be done in accordance with the relevant local and national regulations.**

CONTENTS

BEFORE USE	1	OPERATION MODE	13
GENERAL DESCRIPTION OF SYSTEM	1	Setting operation mode	16
SAFETY CONSIDERATIONS	2	Group monitoring	16
FEATURES AND FUNCTIONS	6	Error diagnosing function	17
NAMES AND FUNCTIONS OF THE		Setting master remote controller	20
OPERATING SECTION	7	Display of time to clean	21
OPERATION	8	INSTALLATION TABLE	22
Individual screen, all screen, zone screen	8	OPTIONAL ACCESSORIES	23
Batch operation and stop method	9	DOUBLE CENTRAL REMOTE	
Group operation and stop method	9	CONTROLLERS	23
Registering zones	9	SPECIFICATIONS	24
Zone operation and stop method	10	Specifications	24
Changing the fan direction and fan strength	11	Outline drawings	24
Changing the ventilation mode and			
ventilation strength	11	Fig. 1, 2, 3, 4	3
Timer Number Setting	11	Fig. 5, 6, 7, 8	4
Setting the Operation Code	12	Fig. 9, 10, 11, 12	25
		Fig. 13, 14, 15, 16	26

FEATURES AND FUNCTIONS

■ Operation menu

This central remote controller can operate and stop machines by either group or zone.
Batch operation and batch stop functions are also available. When used in combination with the schedule timer (optional accessory), timer operation and stop functions are available.



See page
8—12.

■ Various operation modes.

You can operate the system from both this unit and the remote controller, so to enable various operation control patterns. Twenty different operation modes are available including five operation patterns:

1. Start/stop: remote controller prohibition, remote controller stop-only permission, central priority, after-press priority, remote controller permission timer
2. Operation modes: remote controller prohibition, remote controller permission
3. Set temperature: remote controller prohibition, remote controller permission



See page
13—15.

■ Zone control for simpler setting procedures

You can control a maximum of 64 groups of indoor units by using this central remote controller. You don't have to repeat the same setting operations by group because you can make each of the following settings by zone.

A functions is available for setting all groups in one batch.

- Operation mode
- Control mode
- Setting temperature
- Programming time No. (Used in conjunction with the schedule timer)



See page
8—16.

■ Monitoring all indoor unit information

The following information can be displayed by group.

- Operation information such as operation mode, set temperature, etc., for indoor units
- Maintenance information such as cleaning signs for filters or elements
- Error codes and other malfunction diagnosis information



See page
16—21.

■ Function of refrigerant system display













This display helps you understand, at a glance, the indoor units sharing the same outdoor unit and the particular indoor unit among them that is set as the master remote controller.





See page 20.

- Room air conditioners and multi-purpose air conditioners may also be connected by using separately-sold adapter boards.
This may limit functionality, so consult the manuals that come with each adapter board.

NAMES AND FUNCTIONS OF THE OPERATING SECTION (Fig. 1, 2)

1	UNIFIED OPERATION BUTTON Press to operate all indoor units.	13	 ” DISPLAY (COOLING/HEATING SELECTION PRIVILEGE NOT SHOWN) For zones or individual units (groups) for which this is displayed, cooling and heating cannot be selected.
2	UNIFIED STOP BUTTON Press to stop all indoor units.	14	 ” DISPLAY (UNDER HOST COMPUTER INTEGRATED CONTROL) While this display is lit up, no settings can be made. It lights up when the upper central machines are present on the same air conditioning network.
3	OPERATION LAMP (RED) Lit white any of the indoor units under control is in operation.	15	 ” DISPLAY (PRESET TEMPERATURE) Displays the preset temperature.
4	 ” DISPLAY (REFRIGERANT SYSTEM DISPLAY) This indication in the square is lit while the refrigerant system is being displayed.	16	 ” DISPLAY (MALFUNCTION CODE) This displays (flashes) the content of errors when an error failure has occurred. In maintenance mode, it displays the latest error content.
5	 ” DISPLAY (ZONE SETTING) The lamp is lit while setting zones.	17	” NOT AVAILABLE” DISPLAY (NO FUNCTION DISPLAY) If a function is not available in the indoor unit even if the button is pressed, “NOT AVAILABLE” is may be displayed for a few seconds.
6	” MONITOR ” DISPLAY (OPERATION MONITOR) The lamp is lit while operation is being monitored.	18	 ” DISPLAY (FAN DIRECTION SWING DISPLAY) This displays whether the fan direction is fixed or set to swing.
7	” ALL ” “ ZONE ” “ INDIVIDUALLY ” DISPLAY The status displays indicates either batch functions or which zone or individual unit (or group) are being used.	19	 ” DISPLAY (VENTILATION STRENGTH/SET FAN STRENGTH DISPLAY) This displays the set fan strength.
8	OPERATION MONITOR Each square displays the state corresponding to each group.	20	 ” DISPLAY (TIME NO.) Displays the operation timer No. when used in conjunction with the schedule timer.
9	 ” DISPLAY (OPERATION MODE) Displays operating state.		
10	 ” DISPLAY (VENTILATION CLEANING DISPLAY) This is displayed when a Ventiair total enthalpy heat exchanger unit or other such unit is connected.		
11	 ” TEST ” DISPLAY (INSPECTION/TEST) Pressing the maintenance/test run button (for service) displays this. This button should not normally be used.		
12	 ” DISPLAY (TIME TO CLEAN) It lights up when any individual unit (group) has reached the time for the filter or element to be cleaned.		

21	“CODE UNIT No. 18” DISPLAY (OPERATION CODE AND UNIT NUMBER DISPLAY) The method of operation (remote controller prohibited, central operation priority after-press operation priority, etc.) is displayed by the corresponding code. This displays the numbers of any indoor units which have stopped due to an error.
	“” “” DISPLAY (TIME TO CLEAN AIR CLEANER ELEMENT/ TIME TO CLEAN AIR FILTER) Displayed to notify the user it is time to clean the air filter or air cleaner element of the group displayed.
23	VENTILATION MODE BUTTON This is pressed to switch the ventilation mode of the total enthalpy heat exchanger.
24	ALL/INDIVIDUAL BUTTON Pressing this button scrolls through the “all screen”, “zone screen”, and “individual screen”.
25	ARROW KEY BUTTON This button is pressed when calling an individual indoor unit or a zone.
26	ON/OFF BUTTON Starts and stops ALL, ZONE, and INDIVIDUAL units.
27	TEMPERATURE ADJUSTMENT BUTTON (ZONE NUMBER BUTTON) This button is pressed when setting the temperature. Select the zone number if any zones have been registered.
	FAN DIRECTION ADJUSTMENT BUTTON This button is pressed when setting the fan direction to “fixed” or “swing”.
29	OPERATION MODE SELECTOR BUTTON This sets the operation mode. The dry setting cannot be done.
30	TIME NO. BUTTON Selects time No. (Use in conjunction with the schedule timer only).
31	CONTROL MODE BUTTON Selects control mode.
32	FILTER SIGN RESET BUTTON This button is pressed to erase the “clean filter” display after cleaning or replacement.

33	SET BUTTON Sets control mode and time No.
34	FAN STRENGTH ADJUSTMENT BUTTON Pressing this button scrolls through “weak”, “strong”, and “fast”.
	ZONE SETTING BUTTON Zone registration mode can be turned on and off by pressing the start and stop buttons simultaneously for at least four seconds.
36	INSPECTION/TEST RUN BUTTON (FOR SERVICE) Pressing this button scrolls through “inspection”, “test run”, and “system display”. This button is not normally used.
37	VENTILATION STRENGTH ADJUSTMENT BUTTON This button is pressed to switch the ventilation strength (“fresh up”) of the total enthalpy heat exchanger.
	(Notes) 1. Please note that all the displays in the figure appear for explanation purposes or when the cover is open. 2. If the unit is used in conjunction with other optional central controllers, the OPERATION LAMP of the unit that is not under operation control may light up and go out a few minutes behind schedule. This shows that the signal is being exchanged, and does not indicate any failure.

OPERATION

■ Individual screen, all screen, zone screen (Fig. 3)

This controller can perform operations in the individual screen, all screen, or zone screen.

- Individual screen The individual screen is used when performing group operations.
- All screen The all screen is used when performing operations for all units at once.
- Zone screen The zone screen is used when performing zone operations.

1. Select the screen by pressing the “ALL/INDIVIDUAL” button.

 Every time the “ALL/INDIVIDUAL” button is pressed, the selection scrolls through INDIVIDUAL → ALL → ZONE.

If nothing is done in the all or zone screens for one minute, it automatically goes to the individual screen.

- If the zone number in the zone screen is displayed as “--,” this indicates that no units are registered in a zone.
Please perform zone registration before proceeding in the zone screen. (See page 9)

■ Batch operation and stop method (Fig. 4)

This is for operating or stopping all connected units at once.

A. What to do when operating or stopping all connected units at once.

1. Press either “ALL I” or

 “ALL O”.

- Operation can be performed from the individual screen, the all screen, or the zone screen.
- The “TEMPERATURE ADJUSTMENT” and “OPERATION MODE SELECTOR” buttons cannot be used.
To set the temperature and operation mode, use B. batch operation.

B. Batch Operation

1. Press the “ALL/INDIVIDUAL button” to enter the all screen.

The “” display lights up on all registered units.



2. Press the “SELECT” button.

The “” display lights up on all connected units.

 Press the “RESET” button.

The “” display goes off on all connected units.
Operation and stop in the batch screen are done the same as with the batch operation and batch stop buttons.

3. Press the “TEMPERATURE ADJUSTMENT” button.

The temperature rises 1° every time the () button is pressed.
The temperature drops 1° every time the () button is pressed.

Set to “--” when you do not wish to use batch setting for the temperature setting.
Setting to 1° above or below the temperature setting range displays “--”.

4. Call up the desired mode by pressing the “OPERATION MODE SELECTOR” button.

Set to “--” when you do not wish to use batch setting for the operation setting.

■ Group operation and stop method (Fig. 5)

This is for operating or stopping connected units in groups.

[Group operation]

1. Press the “ALL/INDIVIDUAL button” to enter the individual screen.

The unit will enter the individual screen automatically if nothing is done for one minute.

2. Using the arrow keys, move the “” to select the units to operate or stop.

Keeping the button pressed down will move it rapidly.

The “” in this screen has selected unit 1-04.

3. Press the “SELECT” button.

The “” display lights up in the group.

 Press the “RESET” button.

The “” display goes off in the group.

4. Press the “TEMPERATURE ADJUSTMENT” button.

The temperature rises 1° every time the () button is pressed.

The temperature drops 1° every time the () button is pressed.

Temperature adjustment cannot be done if the selected group’s air conditioners are in fan mode.

5. Call up the desired mode by pressing the “OPERATION MODE SELECTOR” button.

■ Registering zones (Fig. 6)

It is possible to set multiple groups as one zone and control each zone separately.

No zones are registered when the unit is shipped from the factory.

Zone registration can be done in the individual screen, all screen, or zone screen.

[Registration]

1. Pressing the “ALL/INDIVIDUAL” button for four seconds. Displays ZONE SET.

Zone Number 1 will be displayed, and if there are any groups already registered in the displayed zone, a “” will light up on the operation monitor.

2. Select the Zone Number to be registered using the “ZONE NUMBER” button. Keeping the button pressed down will move it rapidly.
3. “” to the group you wish to register using the arrow keys. Keeping the button pressed down will move it rapidly.
4. Press the “SELECT” button to register that group to the zone.
The “” display lights up on all the selected units.
 Pressing the “RESET” button removes the group from that zone, and “” goes off.

Repeat steps 3 and 4 until all the units you wish to register to the zone have been added.

	ZONE SET					ZONE										
	00	01	02	03	04	05	06	07	08	09	10	11	12	13	14	15
1-																
2-																
3-																
4-																

In this example, a screen is shown with units 1-00, 1-02, 1-03, and 2-00 registered to Zone Number 1.

5. Repeat steps 2 to 4 to register to the next zone.
 6. Once zone registration is complete, press the “ALL/INDIVIDUAL” button to turn off “ZONE SET” display and return to the individual screen.
The display returns to the normal screen if nothing is done for one minute when in zone registration mode.
- (NOTE)
- It is impossible to register one group to several different zones.
If this is done, the last zone registered to will be valid.

[Batch deletion of zone registration]

1. Pressing the “ALL ○” for at least four seconds while pressing the “FILTER SIGN RESET” button when “ZONE SET” is displayed will delete all zone registrations.
The zone registrations for all units will be lost.

■ Zone operation and stop method (Fig. 7)

This is for operating or stopping connected units in zones.

[Zone operation]

1. Press the “ALL/INDIVIDUAL button” to enter the zone screen.
2. Using the arrow keys, select the zone number to operate or stop.

Pressing and reduces the zone number

while and raise the number.

Keeping the button pressed down will move it rapidly.

- If the zone number is displayed as “--,” this indicates that no units are registered in a zone. Please perform zone registration before using a zone. (See page 9)

3. Press the “SELECT” button.

The “” display lights up in the group.

4. Press the “RESET” button.

The “” display goes off in the group.

4. Press the “TEMPERATURE ADJUSTMENT” button.

The temperature rises 1° every time the (▲) button is pressed.

The temperature drops 1° every time the (▼) button is pressed.

Set to “--” when you do not wish to use zone setting for the temperature setting.

Setting to 1° above or below the temperature setting range displays “--”.

5. Call up the desired mode by pressing the “OPERATION MODE SELECTOR” button.

Set to “--” when you do not wish to use zone setting for the operation mode.

■ Changing the fan direction and fan strength (Fig. 8)

This changes the fan direction and strength settings in the air conditioner.

Changing the fan direction and strength is done in the individual screen.

[Registration]

1. Press the “ALL/INDIVIDUAL button” to enter the individual screen.

The unit will enter the individual screen automatically if nothing is done for one minute.

2. Using the arrow keys, move the “” to select the units to fan direction adjustment or fan strength adjustment.

Keeping the button pressed down will move it rapidly.

3. Press the “FAN DIRECTION ADJUSTMENT” button.

This sets “fixed” or “swing” for the fan direction.

6. Press the “FAN STRENGTH ADJUSTMENT” button.

Pressing this button scrolls through “”, “”, and “”.

Depending on the indoor unit, only “” and “” may be available.

The functions included in the indoor units may vary. Pressing a button for a function which is not available will cause “NOT AVAILABLE” to be displayed.

■ Changing the ventilation mode and ventilation strength (Fig. 9)

This changes the ventilation mode and strength settings in the total enthalpy heat exchanger.

Changing the ventilation mode and strength is done in the individual screen.

[Registration]

1. Press the “ALL/INDIVIDUAL button” to enter the individual screen.

The unit will enter the individual screen automatically if nothing is done for one minute.

2. Using the arrow keys, move the “” to select the units to ventilation mode or ventilation strength adjustment.

Keeping the button pressed down will move it rapidly.

3. Press the “VENTILATION MODE” button.

It will scroll through “” → “” → “” → “”.

6. Press the “VENTILATION STRENGTH ADJUSTMENT” button.

It will scroll through “” → “” → “” →

“” → “”.

The fresh up function may not be available depending on the connected unit model.

The functions included in the indoor units may vary. Pressing a button for a function which is not available will cause “NOT AVAILABLE” to be displayed.

• Ventilation Mode and Amount

If these are changed using the remote controller depending on the unit model, they cannot be displayed on the central remote controller.

To monitor the ventilation mode and amount, check the values on the remote controller.

■ Timer Number Setting (Fig. 10)

(Only when used with the schedule timer)

Using this together with the schedule timer makes it possible to set on and off times four times a day.

[Registration]

1. Pressing the “TIMER NO.” button causes the number set for timer number 1 to blink.

If no timer setting has been made “-” will be displayed.

Select the desired timer number by pressing the “TIMER NO.” button.

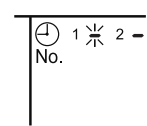

2. Once the desired timer number is displayed, press the “SET” button.

Press the “SET” button within 10 seconds after the timer number is displayed.

The display will return to how it was after 10 seconds.

The display for timer number 1 will stop blinking and then timer number 2 will start blinking.

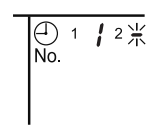

3. Select the desired timer number by pressing the “TIMER NO.” button.

Once the desired timer number is displayed,  press the “SET” button.

The display for timer number 2 will stop blinking.

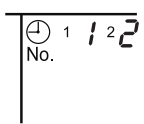

The “ No.” display will disappear after 3 seconds.

Select “-” in the timer number when you do not wish to set a timer number.

It is possible to set only one timer number. (The times for turning the unit(s) on and off twice a day can be set with a single timer number.)

• Timer Number Setting

Group control: select the unit in the individual screen and set the timer number.

Batch control: set the timer numbers for all connected units.

Zone control: set the timer numbers for all zone-registered units.
Call up the zones which you wish to set in the zone screen and set the timer numbers.

- **Since the timer number will be set to after-press priority, the timer number in the last screen set will be valid for the connected units.**

Example 1

Setting timer number 1 for unit 1-00 to “1” and timer number 2 to “2” in the individual screen and then setting timer number 1 to “3” and timer number 2 to “4” in the batch screen causes the timer numbers for all units to be set, so timer number 1 for unit 1-00 will be “3” and timer number 2 will be “4”.

Example 2

To prevent leaving units on, timer number 1 is set to “5” in the batch screen.

Setting timer number 1 in zone number 1 to “-” in the zone screen after that will change the timer number for zone number 1, so the setting to prevent leaving the units on will be lost for zone number 1 only.

If a timer number is set incorrectly by accident, redo the setting in the desired screen.

- **What happens when the timer number on time and off time are set to the same time**

When the on time and off time are set to the same time for the same timer number, operation does not change.

When the on time and off time are set to the same time for different timer numbers, the off time is given priority.

When using timer operation, make sure the times do not overlap when setting the program of the schedule timer.

■ Setting the Operation Code (Fig. 11)

[Registration]

1.  Pressing the “CONTROL MODE” button causes the currently set operation code to blink.

Call up the desired code number by pressing the  “CONTROL MODE” button.

Scroll through the code numbers.

2.  Once the code number is displayed, press the “SET” button.

The display will stop blinking.

The operation code display will disappear after 3 seconds.

[The Operation Code Setting]

Group control: select the unit in the individual screen and set the operation code.

Batch control: set the operation code for all connected units.

Zone control: set the operation code for all zone-registered units.
Call up the zones which you wish to set in the zone screen and set the operation code.

Since the operation code will be set for after-press priority, setting the operation code in the zone and individual screens after setting the operation code in the batch screen, will cause the operation codes set afterwards to be valid.

OPERATION MODE

The following five operation control modes can be selected along with the temperature setting and operation mode by remote controller, for a total of twenty different modes. These twenty modes are set and displayed with control modes of 0 to 19. (For further details, see **EXAMPLE OF OPERATION SCHEDULE** on the next page.)

- ON/OFF control impossible by remote controller..... Use this mode when operating and stopping from the central remote controller only. (ON/OFF control by the remote controller is disabled.)
- Only OFF control possible by remote controller Use this mode when executing the operation only by the central remote controller, and executing only the stop by remote controller.
- Centralized Use this mode when executing the operation only by the central remote controller, and executing start/stop freely by remote controller during the preset hours.
- Individual Use this mode when executing start/stop both by central remote controller and remote controller.
- Timer operation possible by remote controller..... Use this mode when executing start/stop by remote controller during the preset hours, and not starting operation by the central remote controller at the programmed time of system start.

[HOW TO SELECT THE CONTROL MODE]

- Select whether to accept or to reject the operation from the remote controller regarding the operation, stop, temperature setting and operation mode setting, respectively, and determine the particular control mode from the rightmost column of the table below.

Example

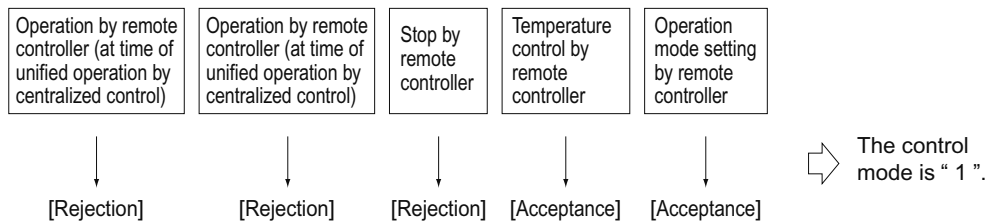

Operation mode	Control by remote controller					Control mode
	Operation		Stop	Temperature control	Operation mode setting	
	Unified operation, individual operation by central remote controller, or operation controlled by timer	Unified stop, individual stop by central remote controller, or timer stop				
ON/OFF control impossible by remote controller	Rejection (Example)	Rejection (Example)	Rejection (Example)	Rejection	Acceptance	0
Only OFF control possible by remote controller				Acceptance (Example)	Rejection (Example)	1 (Example)
Centralized	Acceptance	Acceptance	Acceptance	Rejection	Acceptance	2
Individual				Acceptance	Rejection	3
				Rejection	Acceptance	4
Timer operation possible by remote controller				Acceptance (During timer at ON position only)	Rejection (During timer at OFF position)	Acceptance
				Acceptance	Rejection	6
				Rejection	Acceptance	7
				Acceptance	Rejection	8
				Rejection	Acceptance	9
				Acceptance	Rejection	10
				Rejection	Acceptance	11
				Acceptance	Rejection	12
				Rejection	Acceptance	13
				Acceptance	Rejection	14
				Rejection	Acceptance	15
				Acceptance	Rejection	16
				Rejection	Acceptance	17
				Acceptance	Rejection	18
				Rejection	Acceptance	19

Note) Do not select the timer operation possible without the remote controller. In this case, timer operation is disabled.

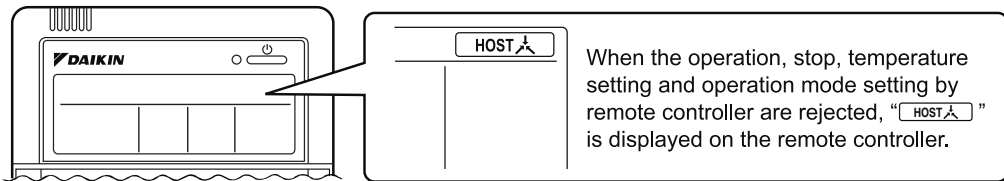

EXAMPLE OF OPERATION SCHEDULE

Operation schedule is possible only in conjunction with the schedule timer (optional accessory).

Liquid crystal display of schedule timer

ON/OFF control impossible by remote controller

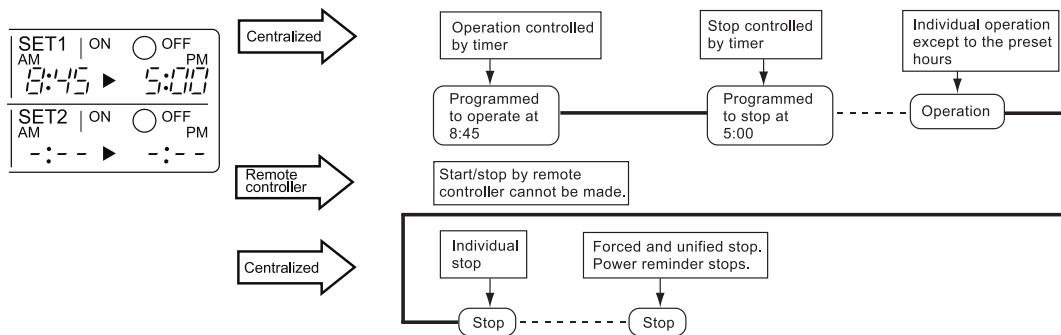

Only OFF control possible by remote controller

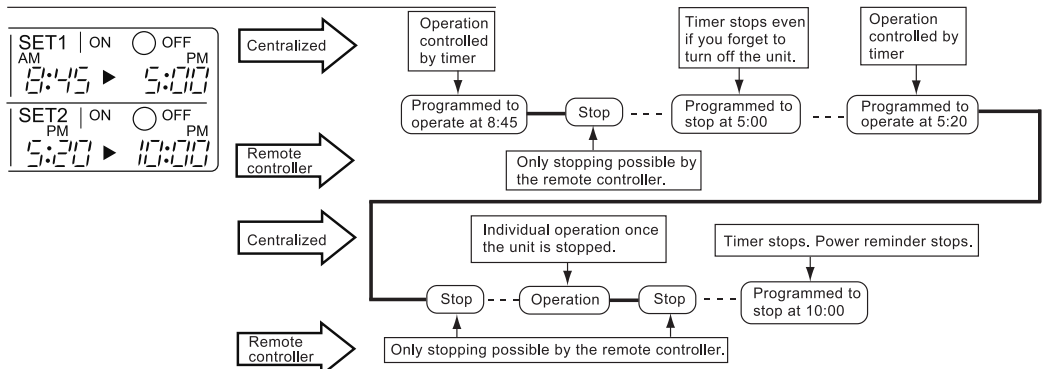

Centralized

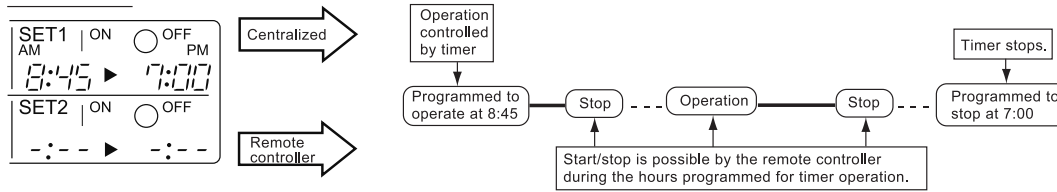

Individual

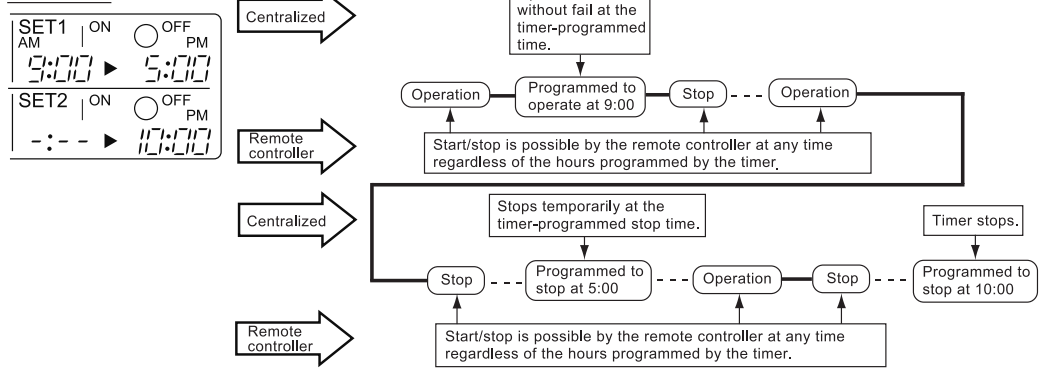

Timer operation possible by remote controller

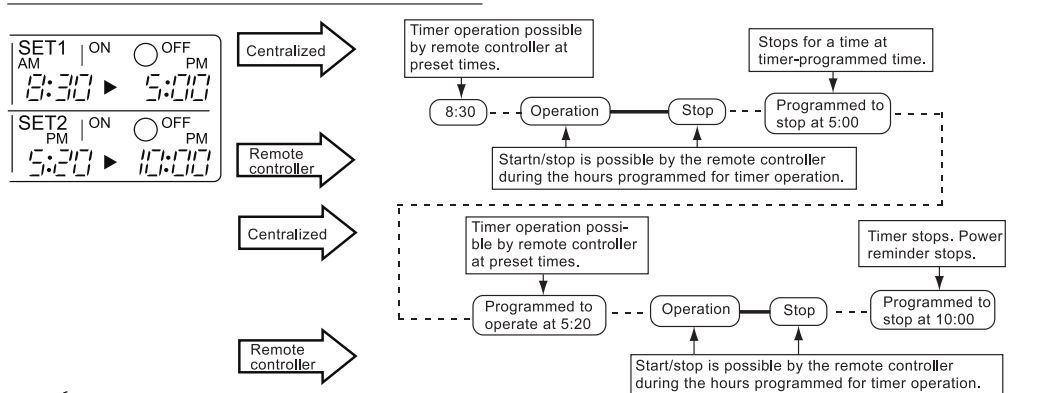

- Air conditioner now operating.
- - - - Air conditioner now stopping.
- ▭ Command by central remote controller
- Command by remote controller

■ Setting operation mode (Fig. 12)

[Registration]

1. Press the OPERATION MODE SELECTOR BUTTON. Each time you press this button, the display rotates as shown on the below list.

- List of operations which can be set
In the below list, “○” refers to the acceptable setting, while “×” refers to the not acceptable setting.

Display	A: Zones and groups with no “ ” display.	
	Setting	Contents of setting
	×	
	○	Can be set in individual zones or groups
	○ * 1	Can be set in individual zones or groups
	○	Can be set in individual zones or groups
	○	Can be set in individual zones or groups
	○ * 1	Can be set in individual zones or groups * 3
	○ * 1	Can be set in individual zones or groups
	○	Select this display if you don't wish to set by zone.

Display	B: Zones and groups with a “ ” display.	
	Setting	Contents of setting
	○	To be set by zone * 2
	○	Can be set in individual zones or groups
	×	
	×	The displays are shown by group * 4
	×	The displays are shown by group * 4
	○ * 1	Can be set in individual zones or groups * 3
	○ * 1	Can be set in individual zones or groups
	○	Select this display if you don't wish to set by zone.

- *1: Setting may not be acceptable depending on the type of indoor unit with which this unit is connected.
- *2: In zone control, the units run in temperature adjustment mode (heating or cooling) for the outdoor system for the groups registered to those zones. Heating or cooling selection is not available.
- *3: or or Changing the ventilation mode cannot be done in the zone screen. Changing the ventilation mode should be done in the individual screen.
- *4: In group control, the units run in temperature adjustment mode (heating or cooling) for the group outdoor system. Heating or cooling selection is not available.

• The Zone consists of the following two cases.

A. Zone without display “ ”

The group with master remote controller setting exists in this zone.
Setting the master remote controller enables cool/heat selection.
Operations other than cool/heat operations can also be set for some operations. For further details, see the list on the left.

B. Zone with display “ ”

No group with master remote controller setting exists in this zone.
The cool/heat selection is not available because the master remote controller has not been set.
Some operations other than cool/heat operations can be set. For further details, see the list in the left.

See page 20 if the display “ ” is flashing.

- Fan operation can be performed for each zone using the central remote controller even if there is no cooling/heating selection right during cooling or heating. Also, if a VentiAir is connected in the zone, ventilation and ventilation cleaning operation is possible. See the included operating manuals for details.
- When the indoor unit is in heat operation, change the setting to FAN operation through the central remote controller; then, you can switch the fan speed to the extremely low fan speed. Warm air may blow if any other indoor unit belonging to the same system is in heat operation.
- The indoor fan stops during defrost/hot start.
- DRY cannot be set from the central remote controller.

■ Group monitoring (Fig. 13)

Utilize the group monitor function in each of the following cases:

1. Check the malfunction code. (See the next page.)
2. Check the group that requires cleaning of the air filter and air cleaner element. (See page 21.)
3. Change the setting of the master remote controller. (See page 20.)
4. Check the group(s) sharing the same outdoor unit. Or, check the particular group(s) with the master remote controller setting. (See page 20.)
5. Check the conditions of other individual groups.

When in zone screen

The zone screen will revert to the individual screen automatically if nothing is done in it for one minute.

[Registration]

1. Press the “ALL/INDIVIDUAL” button to switch to the “INDIVIDUAL” screen.

2. Using the arrow key, move the “” to select the unit to be monitored.

Keeping the button pressed down will move it rapidly.

The “” lights up and the status of that unit is displayed in the LCD. The cursor in the screen Fig. 13 has selected unit 2-06.

■ Error diagnosing function

(Fig. 14)

This central remote controller is provided with a diagnosing function, for when an indoor unit stops due to malfunction. In case of actuation of a safety device, disconnection in transmission wiring for control or failure of some parts, the operation lamp, inspection display and unit No. start to flash; then, the malfunction

code is displayed. Check the contents of the display, and contact your DAIKIN dealer because the above signs can give you the idea on the trouble area.

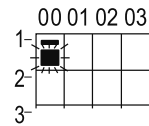

The display “” flashes under the group No. where the indoor unit that has stopped due to malfunction.

[Registration]

1. Press the ARROW KEY BUTTON to call up the group that has stopped due to malfunction.

The unit No. the malfunction code is flashing because of an error failure.

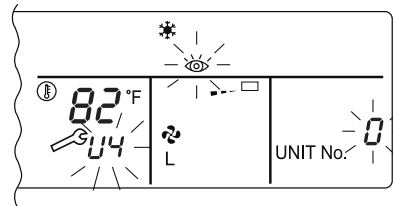

Operation lamp	Maintenance display	Unit No.	Malfunction code	Error content
			64	Indoor air thermistor error
			65	Outdoor air thermistor error
			68	HVU error (Ventiair dust-collecting unit)
			6A	Dumper system error
			6A	Dumper system error + Thermistor error
			6F	Simple remote controller error
			6H	Door switch (Ventiair dust-collecting unit), relay harness fault (Ventiair dust-collecting/humidifier unit)
			94	Ventiair internal transmission error (between total enthalpy – fan unit)
			A0	Indoor unit · external safety device error
			A1	Indoor unit · BEV unit (Sky-Air connection unit) PC board assembly fault
			A1	Indoor unit · PC board assembly fault
			A3	Indoor unit · Drain level error (33H)
			A6	Indoor unit · Fan motor (51F) lock, overload
			A7	Indoor unit · Fan direction adjustment motor (MA) error
			A9	Indoor unit · BEV unit, electric expansion valve motor (20E) error
			AF	Indoor unit · Malfunctioning drain
			AH	Indoor unit · Dust-collector error
			AJ	Indoor unit · Insufficient capacity setting, address setting fault

☼	☼	☼	C4	Indoor unit · Liquid piping thermistor (Th2) Error (faulty connection, cut wire, short circuit, fault)
☼	☼	☼	C5	Indoor unit · BEV unit, gas piping thermistor (Th3) Error (faulty connection, cut wire, short circuit, fault)
☼	☼	☼	C9	Indoor unit · Intake air thermistor (Th1) Error (faulty connection, cut wire, short circuit, fault)
☼	☼	☼	CA	Indoor unit · Outlet air thermistor (Th4) Error (faulty connection, cut wire, short circuit, fault)
☼	●	☼	CJ	Indoor unit · remote controller sensor error
☼	☼	☼	E0	Outdoor unit · Safety device operation
☼	☼	☼	E1	Outdoor unit · PC board assembly fault
☼	●	☼	E1	Outdoor unit · PC board assembly fault
☼	☼	☼	E3	Outdoor unit · High-pressure switch fault
☼	☼	☼	E4	Outdoor unit · Low-pressure switch fault
☼	☼	☼	E9	Outdoor unit · Electric expansion valve motor (20E) error
☼	●	☼	EC	Heat source unit · Intake water temperature inter-lock operation (fan operation)
☼	☼	☼	EF	Outdoor unit · Ice thermal storage unit error
☼	☼	☼	F3	Outdoor unit · Discharge piping temperature error
☼	●	☼	H3	Outdoor unit · High-pressure switch operation
☼	☼	☼	H4	Outdoor unit · Low-pressure switch operation
☼	☼	☼	H9	Outdoor unit · Outdoor air thermistor (Th1) Error (faulty connection, cut wire, short circuit, fault)
☼	●	☼	H9	Outdoor unit · Outdoor air thermistor (Th1) Error (faulty connection, cut wire, short circuit, fault)
☼	●	☼	HC	Outdoor unit · Water temperature sensor system error
☼	●	☼	HF	Ice thermal storage unit error, ice thermal storage controller error, error in outdoor unit during ice thermal storage operation
☼	☼	☼	HJ	Outdoor unit · water system fault
☼	☼	☼	J1	Outdoor unit · pressure sensor error
☼	☼	☼	J3	Outdoor unit · Discharge piping thermistor (Th3) Error (faulty connection, cut wire, short circuit, fault)
☼	●	☼	J3	Outdoor unit · Discharge piping thermistor (Th3) Error (faulty connection, cut wire, short circuit, fault)
☼	☼	☼	J5	Outdoor unit · Intake piping thermistor (Th4) Error (faulty connection, cut wire, short circuit, fault)
☼	☼	☼	J6	Outdoor unit · Heat exchange thermistor (Th2) error
☼	●	☼	J6	Outdoor unit · Heat exchange thermistor (Th2) error Error (faulty connection, cut wire, short circuit, fault)
☼	☼	☼	J7	Outdoor unit · Header thermistor (Th6) error
☼	☼	☼	JA	Outdoor unit · Discharge piping pressure sensor error
☼	☼	☼	JC	Outdoor unit · Intake piping pressure sensor error
☼	☼	☼	JF	Outdoor unit · Oil temperature sensor (Th5) system error
☼	●	☼	JH	Outdoor unit · Oil temperature sensor (Th5) system error
☼	☼	☼	L0	Outdoor unit · Inverter system fault
☼	☼	☼	L4	Outdoor unit · Inverter cooler fault
☼	☼	☼	L5	Outdoor unit · Ground circuit for compressor motor, short circuit, or power unit short circuit

☼	☼	☼	L6	Outdoor unit · Ground circuit for compressor motor, short circuit
☼	☼	☼	L8	Outdoor unit · Compressor overload, compressor motor wire disconnection
☼	☼	☼	L9	Outdoor unit · Compressor lock
☼	☼	☼	LA	Outdoor unit · Power unit error
☼	☼	☼	LC	Outdoor unit · Transmission error between inverter and outdoor control unit
☼ or ●	☼	☼	M1	Central controller: PC board fault
☼ or ●	☼	☼	M8	Transmission error between central controllers
☼ or ●	☼	☼	MA	Central controller: Incorrect combination
☼ or ●	☼	☼	MC	Central controller: Address setting fault
☼	●	☼	P0	Insufficient gas (thermal storage)
☼	☼	☼	P1	Outdoor unit · Power voltage imbalance, phase loss
☼	☼	☼	P4	Outdoor unit · Power unit temperature sensor error
☼	●	☼	U0	Pressure drop due to insufficient refrigerant, electric expansion valve fault, etc.
☼	☼	☼	U1	Reversed or lost phase
☼	☼	☼	U2	Power voltage error, momentary electrical stoppage
☼	☼	☼	U4	Transmission error between indoor unit/BEV unit and outdoor/BS unit, Transmission error between outdoor unit and BS unit
☼	☼	☼	U5	Transmission error between remote controller and indoor control unit
●	☼	●	U5	Remote controller board fault or remote controller setting fault
☼	☼	☼	U6	Transmission error between indoor units
☼	☼	☼	U7	Transmission error between outdoor units Transmission error between outdoor unit and ice thermal storage unit
☼	●	☼	U7	Transmission error between outdoor units (cooling/heating batch, low-noise operation)
☼	☼	●	U8	Transmission error between master remote controller and slave remote controller (slave remote controller error) Incorrect combination of indoor unit and remote controller within a single system (model)
☼	☼	☼	U9	Transmission error between indoor unit/BEV unit and outdoor unit within a single system Transmission error between BS unit and indoor unit/BEV unit and outdoor unit within a single system
☼	☼	☼	UA	Incorrect combination of indoor, BS, and outdoor units within a single system (model, number of units, etc.) Incorrect combination of indoor unit and remote controller (remote controller in question) BS unit connection position fault
☼	●	☼	UC	Central control group numbers overlap
☼	☼	☼	UE	Transmission error between indoor unit and central controller
☼	☼	☼	UF	Unset system, incorrect settings between BEV unit and indoor unit
☼	☼	☼	UH	System fault

■ error codes (in outline font) do not display “maintenance” and the system will run, but please check the content of the display and contact your dealer.

■ Setting master remote controller (Fig. 15)

You must set the master remote controller of the operation mode for one of the indoor units, if two or more such indoor units with the remote controller are connected with the outdoor unit where the operation modes such as cool/heat operation and FAN operation can be set by remote controller and central remote controller.

1. Preparations

When you want to fix settings

- Check the particular group with the master remote controller setting for the refrigerant system you wish to reset. (See the below.)

- Call up the group without the display

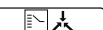
“” (See page 16.)



 Hold the OPERATION MODE SELECTOR BUTTON down for about four seconds while the above group is being called up.

The display “” flashes on the liquid crystal display of the remote controller for all the groups sharing the same outdoor unit or BS unit.

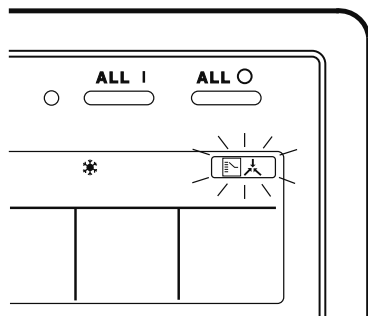
When you turn on the power switch for the first time, the display “” flashes.

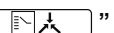

2. Setting selection right

Pull up the desired group to set the master remote controller, and  press the OPERATION MODE SELECTOR BUTTON. The master remote controller is set for this group, and the display “” goes out. The display “” appears for the other groups. Setting is finished now.



When switching operation

- In case of operation switch



Call up the zone including the group with the setting of master remote controller.

(Zone without the display “”)

 Press the OPERATION MODE SELECTOR BUTTON several times, and switch to the desired operation mode.

Each time you press it, the display is switched to “” “” “” and “--” in sequence.

NOTE

- However, the displays “” “” and “VENTILATION MODE” may appear in some zones, depending on the type on indoor unit with which they are connected.

(VENTILATION MODE)





[System Display]

1. Test run mode is necessary to display the system display.
2. In order to turn on test run mode, select the appropriate air conditioner on the individual screen with the cursor and then set its operation mode to either cooling or heating. (It makes no difference if the air conditioner is running or not running while this operator is being performed.)
3. Press the “inspection/test run” button twice to put it into test run mode.
4. Pressing the “inspection/test run” button for four or more seconds in test run mode will display  the “REF CIRCUIT.”

REF CIRCUIT		1-03													
00	01	02	03	04	05	06	07	08	09	10	11	12	13	14	15
1	■		■	■	■	■									
2		■	■												
3															
4															

Call the unit whose system you wish to look up using the arrow keys.

The “” on all groups in the same system as the displayed group will light up.

Of those, the “” display in all groups which have cooling/heating selection privilege will blink.

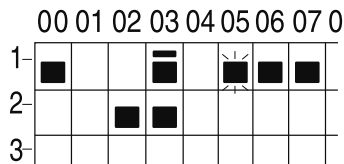

In this example, individual units 1-00, 1-03, 1-05, 1-06, 1-07, 2-02, and 2-03 are in the same system, and 1-05 has the cooling/heating selection privilege.

To look up other systems, call up all the units you wish to look up using the arrow keys.

Pressing the inspection/test run button one more time gets rid of the system display and ends it.

The unit will enter the individual screen automatically if nothing is done for one minute in the system display screen.



This function may not be available for all connected outdoor units, in which case “REF CIRCUIT” will blink. It will also not be correctly displayed if DIII-NET extension ADP is used.

■ Display of time to clean (Fig. 16)



This central remote controller displays the time to clean the air filter or air cleaner element for each group or any given group by utilizing two types of signs. The display “” tells the time to clean the air filter or the air cleaner element of some group.

If a cleaning sign is displayed

A filter or element in some group is ready to be cleaned.



1.  Press the **ARROW KEY BUTTON**, and search the groups displaying “” or “” (The group may be plural.)

Clean or change the air filter or air cleaner element.

For further details, see the operation manual attached to each indoor unit. (Clean or change the air filter or air cleaner element of all the groups displaying “” or “”.)

2.  Press the **FILTER SIGN RESET BUTTON**, and the display “” disappears. (Including all the groups where the air filter has been cleaned.)

NOTE

Be sure to check the display  “” has disappeared at this point. The appearance of the above display is a sign that the air filter or air cleaner element of some group still needs cleaning.







INSTALLATION TABLE

When installing the equipment, mark the zone No. of each group and installation location in the below table.

Setting group No.

(Setting is not possible unless power is activated to both the central remote controller and indoor unit.)

Operated by remote controller

1. Activate power to both the central remote controller and indoor unit.
2. While in the normal mode, hold down the “” button for a minimum of 4 seconds. The unified ON/OFF controller will enter the FIELD SET MODE.
3. Select the MODE No. “” with the “” button.
4. Use the “” button to select the group No. for each group. (Group No. increases in the order of 1-00, 1-01 ... 1-15, 2-00, ... 8-15.)
5. Press “” to set the selected group No.
6. Press “” to return to the NORMAL MODE.

Operated by simplified remote controller

1. Activate power to both the central remote controller and indoor unit.
2. Remove the upper part of the remote controller.
3. Press the **BS6** BUTTON (field set) on the PC board. The controller will enter the FIELD SET MODE.
4. Select the MODE No. “” with the **BS2** BUTTON and **BS3** BUTTON (temperature setting).
5. Use the **BS9** BUTTON (set A) and **BS10** BUTTON (set B) to select the group No. for each group. (Group No. increases in the order of 1-00, 1-01 ... 1-15, 2-00, ... 8-15.)
6. Press **BS7** BUTTON (set/cancel) to set the selected group No.
7. Press **BS6** BUTTON (field set) to return to the NORMAL MODE.

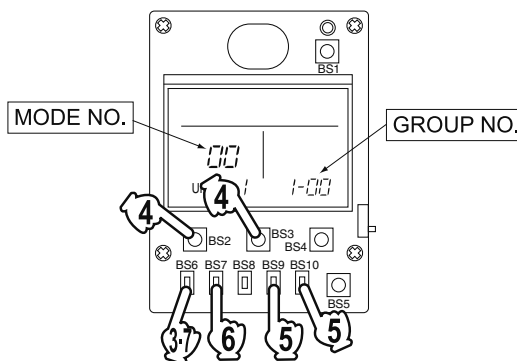
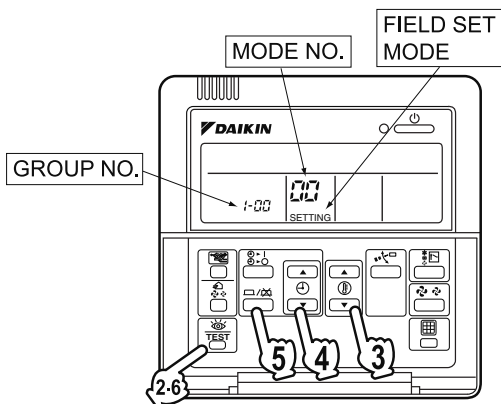

Zone No.																
Group No.	-00	-01	-02	-03	-04	-05	-06	-07	-08	-09	-10	-11	-12	-13	-14	-15
Indoor unit Quantity of units Controlled by																
Location																
Zone No.																
Group No.	-00	-01	-02	-03	-04	-05	-06	-07	-08	-09	-10	-11	-12	-13	-14	-15
Indoor unit Quantity of units Controlled by																
Location																

Zone No.																
Group No.	-00	-01	-02	-03	-04	-05	-06	-07	-08	-09	-10	-11	-12	-13	-14	-15
Indoor unit Quantity of units Controlled by																
Location																
Zone No.																
Group No.	-00	-01	-02	-03	-04	-05	-06	-07	-08	-09	-10	-11	-12	-13	-14	-15
Indoor unit Quantity of units Controlled by																
Location																

OPTIONAL ACCESSORIES

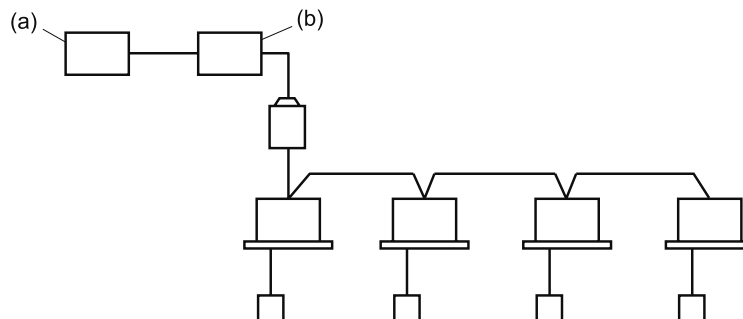

You can perform the normal operation, take off the malfunction contact point and unified start/stop by contact point, all by connecting this unit with the unification adaptor for computerized control. For further details, ask your DAIKIN dealer.

(a) Unification adaptor for computerized control (b) Central remote controller

DOUBLE CENTRAL REMOTE CONTROLLERS

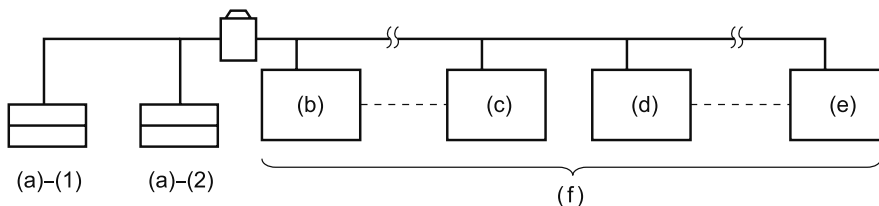

With two central remote controllers, centralized control (indoor units) is possible from different locations.

(a) Central remote controller (b) Group No. 1 - 00 (c) Group No. 1 - 15 (d) Group No. 2 - 00
 (e) Group No. 4 - 15 (f) A maximum of 64 groups

Note)

- For control alignment and settings for double central remote controllers, contact your dealer.

SPECIFICATIONS

■ Specifications

Power supply	1 ~ 50/60Hz, 100V - 240V
Power consumption	Max. 8W
Forced ON/OFF input	Continuous "a" contact Contact current: approximately 10mA
Size	180 (W) × 120 (H) × 64.5 (D)
Weight	420g

■ Outline drawings

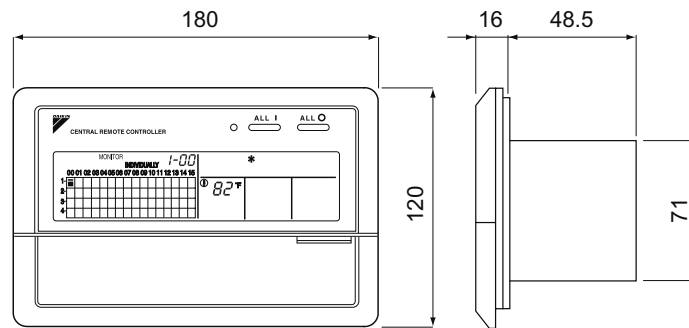

When using this unit an electric parts box of KJB311A is required.
For installation, a steel electric parts box to be embedded is mandatory.

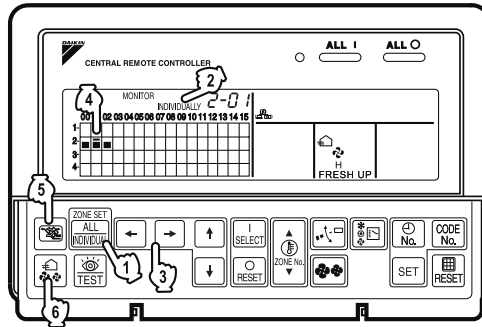

Fig. 9

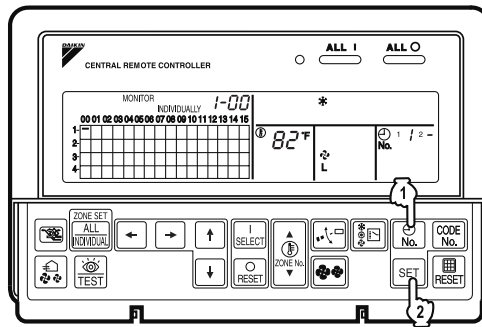

Fig. 10

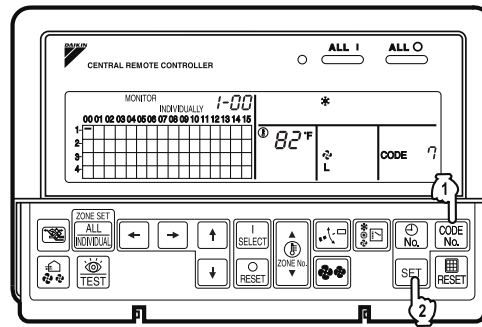

Fig. 11

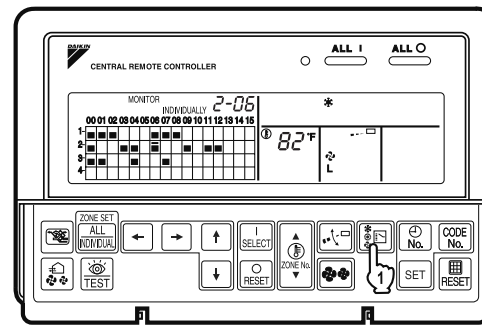

Fig. 12

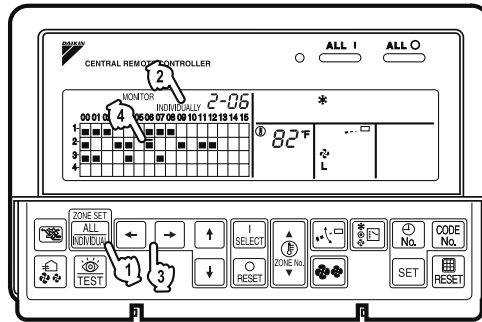

Fig. 13

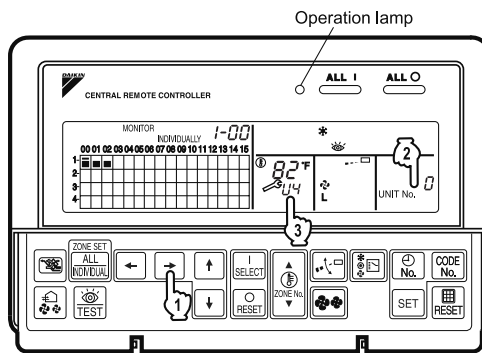

Fig. 14

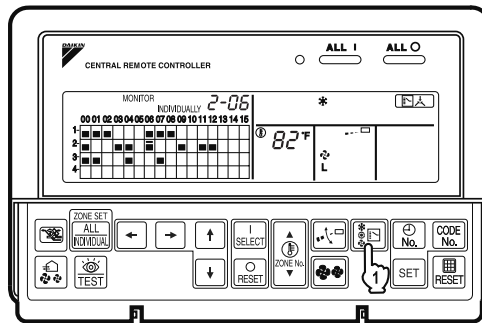

Fig. 15

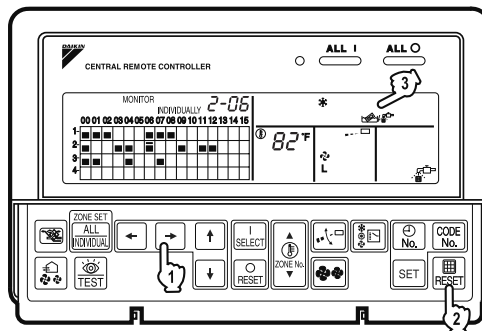





Fig. 16

13.9 <DCS301C71> Unified ON/OFF Controller Installation Manual

Please read these "SAFETY CONSIDERATIONS" carefully before installing air conditioning equipment and be sure to install it correctly. After completing the installation, make sure that the unit operates properly during the start-up operation.
Please instruct the customer on how to operate the unit and keep it maintained.
Also, inform customers that they should store this installation manual along with the operation manual for future reference.
This air conditioner comes under the term "appliances not accessible to the general public".

Meaning of warning, caution and note symbols.

-  **WARNING**..... Indication a potentially hazardous situation which, if not avoided, could result in death or serious injury.
 **CAUTION**..... Indication a potentially hazardous situation which, if not avoided, may result in minor or moderate injury. It may also be used to alert against unsafe practices.
 **NOTE**..... Indication situation that may result in equipment or property-damage-only accidents.

WARNING

Ask your dealer or qualified personnel to carry out installation work. Do not try to install the machine by yourself.

Improper installation may result in water leakage, electric shocks or fire.

Perform installation work in accordance with this installation manual.

Improper installation may result in water leakage, electric shocks or fire.

Be sure to use only the specified accessories and parts for installation work.

Failure to use the specified parts may result in water leakage, electric shocks, fire or the unit falling.

Carry out the specified installation work after taking into account strong winds, typhoons or earthquakes.

Improper installation work may result in the equipment falling and causing accidents.

Make sure that a separate power supply circuit is provided for this unit and that all electrical work is carried out by qualified personnel according to local laws and regulations and this installation manual.

An insufficient power supply capacity or improper electrical construction may lead to electric shocks or fire.

Make sure that all wiring is secured, the specified wires are used, and no external forces act on the terminal connections or wires.

Improper connections or installation may result in fire.

When wiring the power supply and connecting the remote controller wiring and transmission wiring, position the wires so that the electric parts box lid can be securely fastened.

Improper positioning of the electric parts box lid may result in electric shocks, fire or the terminals overheating.

Before touching electrical parts, turn off the unit.

Ground the air conditioner. Do not connect the ground wire to gas or water pipes, lightning rod or a telephone ground wire.

Incomplete grounding may result in electric shocks.

When installing or relocating the system, be sure to keep the refrigerant circuit free from substances other than the specified refrigerant (R410A), such as air.

Do not reconstruct or change the settings of the protection devices.

If the pressure switch, thermal switch, or other protection device is shorted and operated forcibly, or parts other than those specified by Daikin are used, fire or explosion may result.

Do not touch the switch with wet fingers.

Touching a switch with wet fingers can cause electric shock.

Install a leak circuit breaker, as required.

If a leak circuit breaker is not installed, electric shock may result.

Do not install the air conditioner or the remote controller in the following locations:

- (a) where a mineral oil mist or an oil spray or vapor is produced, for example in a kitchen
Plastic parts may deteriorate and fall off or result in water leakage.
- (b) where corrosive gas, such as sulfuric acid gas, is produced
Corroding copper pipes or soldered parts may result in refrigerant leakage.
- (c) near machinery emitting electromagnetic waves
Electromagnetic waves may disturb the operation of the control system and result in a malfunction of the equipment.
- (d) where flammable gases may leak, where there are carbon fiber or ignitable dust suspensions in the air, or where volatile flammables such as thinner or gasoline are handled.
Operating the unit in such conditions may result in fire.

CAUTION

Be very careful about product transportation.

Safely dispose of the packing materials.

Packing materials, such as nails and other metal or wooden parts, may cause stabs or other injuries.

Tear apart and throw away plastic packaging bags so that children will not play with them. If children play with a plastic bag which was not torn apart, they face the risk of suffocation.

Do not turn off the power immediately after stopping operation.

Always wait at least five minutes before turning off the power. Otherwise, water leakage and trouble may occur.

NOTE

Install the indoor and outdoor units, power supply wiring and connecting wires at least 3.5ft. away from televisions or radios in order to prevent image interference or noise.

(Depending on the radio waves, a distance of 3.5ft. may not be sufficient enough to eliminate the noise.)

Remote controller (wireless kit) transmitting distance can result shorter than expected in rooms with electronic fluorescent lamps.

(inverter or rapid start types)

Install the indoor unit as far away from fluorescent lamps as possible.

This unit is a class A product.

In a domestic environment this product may cause radio interference in which case the user may be required to take adequate measures.

Dismantling of the unit, treatment of the refrigerant, oil and eventual other parts, should be done in accordance with the relevant local and national regulations.

1 COMPONENTS

Check the following components are included in this optional accessory before installation.

Body

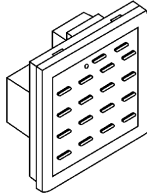

Installation screw (M4 x 16)	2
Operation manual	1
Installation manual	4
Installation table	4
Switch display sticker	1

When using this optional accessory an electric parts box of KJB212A is required. For installation, a steel electric parts box to be embedded is mandatory.

2 SYSTEM CONFIGURATION

This unified ON/OFF controller enables individual and unified operation/stop for a maximum of 16 groups of indoor units. With 2 to 8 unified ON/OFF controllers, individual and unified control is possible with up to a maximum 128 groups of indoor units.

- When using 1 unified ON/OFF controller

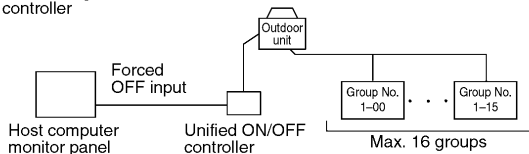

(This optional accessory can not be used in conjunction with wiring adapter for electrical appendices (optional accessory).)

- When using 2 to 8 unified ON/OFF controllers

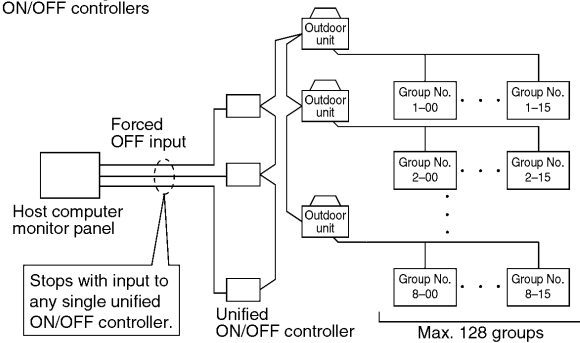

The groups of indoor units are as follows:

- 1 One indoor unit without remote controller

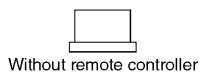

- 2 One indoor unit controlled by one or two remote controllers

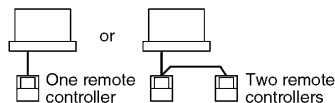

- 3 A maximum of 16 indoor units controlled in groups by one or two remote controllers

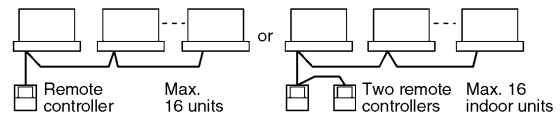

3 INSTALLATION

- 1 Open the upper part of remote controller. Insert a ⊖ screwdriver (2 locations) into the recess between the upper part and the lower part of remote controller and twist the screwdriver lightly.

PC board is attached with both the upper and lower part of remote controller. Do not damage the board with the screwdriver.

- 2 Open the upper part of remote controller and install the electric parts box (part to be procured in the field) with the attached installation screws (M4 x 16).

NOTE) Suitable length of the electric wire is about 160mm from the inlet of the electric parts box. If it is difficult to contain a long wiring, strip the sheathed part of the wiring.

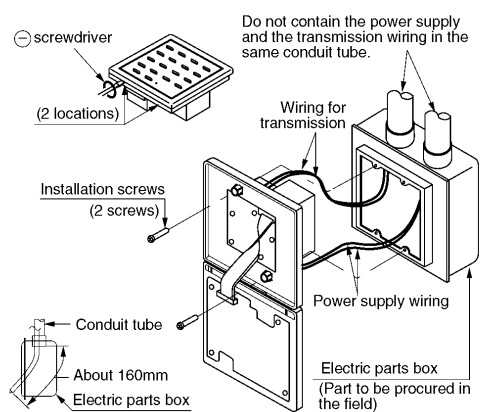

4 INITIAL SETTING

Setting ① through ③ are initialized when power is turned ON, therefore complete settings BEFORE activating the power.

- Connector for setting master controller (X1A) (Provided with connector at factory set)
 - When using 1 unified ON/OFF controller, do not disconnect the connector for setting master controller. (Use the unit with the connector in the state in which it was delivered.)
 - When using multiple unified ON/OFF controllers, or using the unified ON/OFF controller in conjunction with other optional controllers for centralized control, makes settings as indicated in the right table.

Pattern of connection of optional controllers for centralized control			Connector for setting master controller (X1A) Settings		
Unified ON/OFF controller	Central remote controller	Schedule timer	Unified ON/OFF controller	Central remote controller	Schedule timer
1 to 16	1 to 4	1	Set one to "Used" and all the rest to "Not used". Set all to "Not used".	(Note)	"Not used"
	1 to 4	1	Set one to "Used" and all the rest to "Not used". Set all to "Not used".	(Note)	"Not used"
	1 to 4	1	Set all to "Not used".	(Note)	"Not used"

(Note) For instructions on how to set the connector for setting master controller on the central remote controller, see the installation manual provided with the central remote controller.

- Switch for setting each address (DS1)
These switches are used to set group control address.
Groups Nos. 1-00 through 1-15 are grouped in the same control group when the unit is shipped from the factory.

Each Address	1-00 ~ 1-15	2-00 ~ 2-15	3-00 ~ 3-15	4-00 ~ 4-15	5-00 ~ 5-15	6-00 ~ 6-15	7-00 ~ 7-15	8-00 ~ 8-15
DS1 setting								

NOTE) ■ indicates the position of switches.

After setting, attach the number seal applicable to respective control range of the attached switch display sticker, as shown in the diagram below.

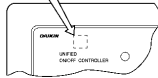

(Example)
In the case of 1-00 to 1-15, attach 1.

- MAIN/SUB changeover switch setting
With two unified ON/OFF controllers, centralized control (indoor units) is possible from different locations. In this kind of set-up, it is necessary to set the MAIN/SUB changeover switch.
One of the two unified ON/OFF controllers (1)-(2) is set to "MAIN" while the other is set to "SUB".

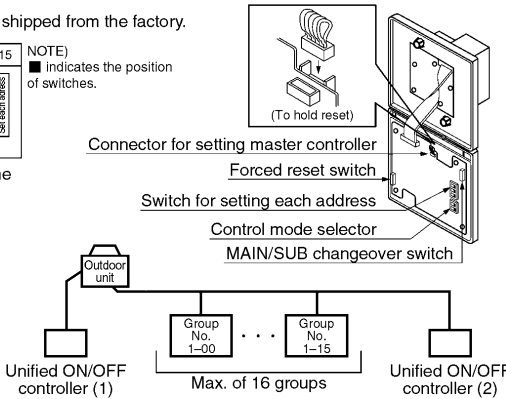

- Setting of the sequential operation function
The unified ON/OFF controller is equipped with a sequential operation function that sequentially turns indoor units on in 2-second intervals during unified operation. (Sequential operation is factory set to "ON.")
To switch sequential operation ON or OFF, set as follows.

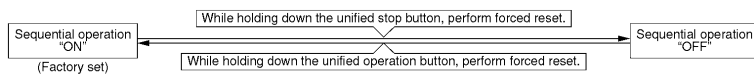

NOTE: The sequential operation function is designed to reduce the load on the power supply equipment, but does not guarantee that compressors will not be started simultaneously. You cannot therefore count on a capacity reduction effect by power supply equipment breaker selection.

- Control mode selector (DS2)
The following four patterns of control mode can be set.

Control mode	Individual	Centralized	Timer operation possible by remote controller	ON/OFF control impossible by remote controller
Content	Operation/stop is controlled by both unified ON/OFF controller and remote controller.	After operated by unified ON/OFF controller, operation/stop is freely controlled by remote controller until stopped by unified ON/OFF controller.	When used in conjunction with schedule timer, operation/stop is controlled freely by remote controller during the set time but operation is not available when schedule timer is ON.	Operation/stop is controlled by unified ON/OFF controller only. (This unit can not be operated/stopped by remote controller.)
DS2 setting	(Factory set)			

- NOTES)
- indicates the position of switches.
 - Set control mode before turning power supply ON.
 - When used in conjunction with central remote controller, the control modes of the central remote controller has the priority.

- Forced reset switch (SS1)
When changing the setting of the connector for setting master controller, etc., you can reset simply by setting it to the reset side once and returning to the normal side, without turning the power OFF.
(For normal operation, set the switch to the normal side.)

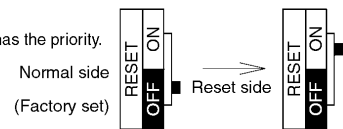

5 ELECTRIC WIRING

GENERAL INSTRUCTIONS

- All wiring, components and materials to be procured on the site must comply with the applicable local and national codes.
- Use copper conductors only.
- All field wiring and components must be provided by licensed electrician.
- Unit shall be grounded in compliance with the applicable local and national codes.
- Fit the power supply wiring with a fuse and a switch.
- After wiring work, check power to the equipment shuts OFF when switch is shut OFF.

WIRING OUTLINE

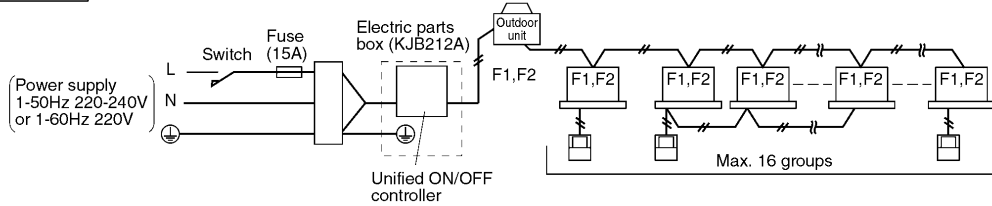

Wiring specification

	Type	Size
Power supply wiring	H05VV-U3G	(NOTE 1)
Transmission wiring	Sheathed wire (2 wire) (NOTE 2)	0.75 - 1.25mm ²

- NOTES) 1. The size of power supply wiring must comply with the applicable national and local codes.
 2. Allowable length of transmission wiring is as follows.
 Max. 1000m (Total wiring length: 2000m)

Connect the wiring between indoor and outdoor units, indoor/outdoor units and power supply, and indoor units and remote controllers. For details, refer to the installation manuals of indoor and outdoor units.

WIRING TO THE INDOOR UNIT AND OUTDOOR UNIT

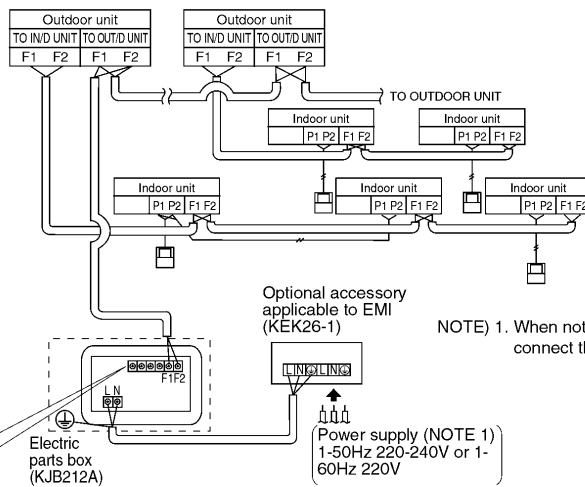

NOTE) 1. When not using the optional accessory applicable to EMI (KEK26-1), connect the power supply wiring directly to the unified ON/OFF controller.

CONTROL TERMINAL STRIP

- *1 For connecting indoor unit (F1, F2)
- *2 Forced OFF input (T1, T2)

While the forced OFF input (no voltage contactor, for micro current) is ON (energized), all the connected indoor units are stopped and can not be operated. Use only contactors which guarantee the minimum applicable load ≧ 16V, 10mA.

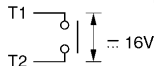

NOTE) Use instantaneous contactor of over 200msec. energizing time, when necessary.

- *3 For schedule timer (D1, D2)

Power can be supplied to the schedule timer (DST301B51*61 optional accessory). For details, refer to the installation manual of the schedule timer. Wire *2 and *3 only when necessary.

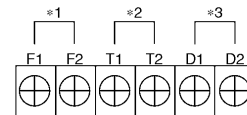







(NOTE)

Do not connect the power supply wiring (220 to 240V) to the control terminal strip. If connected by mistake, it may damage or burn electrical parts of optional controllers for centralized control and indoor unit. It may result in serious danger. Be sure to check wirings before turning the power ON.

6 SETTING GROUP NO. FOR CENTRALIZED CONTROL

Set the group number of each group of the indoor unit from the remote controller. (In case of no remote controller, also connect the remote controller and set the group No. Then, remove the remote controller.)

- 1 Turn ON the power of the indoor unit and unified ON/OFF controller. (Unless the power is ON, no setting can be made.)
Check that the installation and electrical wiring are correct before turning the power supply ON.
When the power supply is turned ON, all LCD appear once and the unit may not accept the operation for about one minute with the display of "  " flashing (an interval of ON, ON, and OFF).
- 2 While in the normal mode, hold down the "  " button for a minimum of 4 seconds.
The remote controller will enter the FIELD SET MODE.
- 3 Select the MODE No. "  " with the "  " button.
- 4 Use the "  " button to select the group No. for each group.
(Group numbers increase in the order of 1-00, 1-01, ... 1-15, 2-00, ... 8-15.)
- 5 Press "  " to set the selected group No.
- 6 Press "  " to return to the NORMAL MODE.

- NOTES)
- For simplified remote controller, see the installation table.
 - For setting group No. of HRV and wiring adaptor for other air conditioners, etc., refer to the instruction manual attached.

NOTICE Enter the group No. and installation place of the indoor unit into the attached installation table.
Be sure to keep the installation table with the operation manual for maintenance.

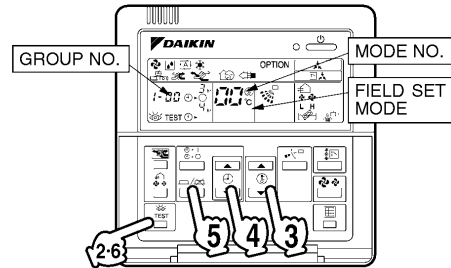

7 CONFIRMING OPERATION

Before starting test operation, supply power to the indoor units, outdoor units, and unified ON/OFF controller and press the ON/OFF BUTTON.

If the operation lamp flashes, it indicates a malfunction in the indoor unit of the applicable group.



If the display of "  " flashes, it indicates a malfunction in the optional controllers for centralized control. Check for such malfunctions.

- NOTES**
- For test operation of indoor and outdoor units, refer to the installation manual attached with the outdoor unit.
 - After turning the power supply ON, if the unit does not accept operation for two minutes or more with the display of "  " flashing, check the following points.
 - Check that setting of the connector for setting master controller is correct.
 - Check that the group No. for centralized control has been set.

13.10 <DCS301C71> Unified ON/OFF Controller Operation Manual

Please read these "SAFETY CONSIDERATIONS" carefully before installing air conditioning equipment and be sure to install it correctly. After completing the installation, make sure that the unit operates properly during the start-up operation.
Please instruct the customer on how to operate the unit and keep it maintained.
Also, inform customers that they should store this installation manual along with the operation manual for future reference.
This air conditioner comes under the term "appliances not accessible to the general public"

Meaning of warning, caution and note symbols.

-  **WARNING** Indication a potentially hazardous situation which, if not avoided, could result in death or serious injury.
-  **CAUTION** Indication a potentially hazardous situation which, if not avoided, may result in minor or moderate injury. It may also be used to alert against unsafe practices.
-  **NOTE** Indication situation that may result in equipment or property-damage-only accidents.

Keep these warning sheets handy so that you can refer to them if needed.

Also, if this equipment is transferred to a new user, make sure to hand over this operation manual to the new user.

WARNING

In order to avoid electric shock, fire or injury, or if you detect any abnormality such as smell of fire, turn off power and call your dealer for instructions.

Ask your dealer for installation of the air conditioner.

Incomplete installation performed by yourself may result in a water leakage, electric shock, and fire.

Ask your dealer for improvement, repair, and maintenance.

Incomplete improvement, repair, and maintenance may result in a water leakage, electric shock, and fire.

Improper installation or attachment of equipment or accessories could result in electric shock, short-circuit, leaks, fire or other damage to the equipment. Be sure only to use accessories made by Daikin which are specifically designed for use with the equipment and have them installed by a professional.

Ask your dealer to move and reinstall the air conditioner or the remote controller.

Incomplete installation may result in a water leakage, electric shock, and fire.

Never let the indoor unit or the remote controller get wet.

It may cause an electric shock or a fire.

Never use flammable spray such as hair spray, lacquer or paint near the unit.

It may cause a fire.

Never replace a fuse with that of wrong ampere ratings or other wires when a fuse blows out.

Use of wire or copper wire may cause the unit to break down or cause a fire.

Never inspect or service the unit by yourself.

Ask a qualified service person to perform this work.

Cut off all electric waves before maintenance.

Do not wash the air conditioner or the remote controller with excessive water.

Electric shock or fire may result.

Do not install the air conditioner or the remote controller at any place where flammable gas may leak out.

If the gas leaks out and stays around the air conditioner, a fire may break out.

Do not touch the switch with wet fingers.

Touching a switch with wet fingers can cause electric shock.

CAUTION

After a long use, check the unit stand and fitting for damage.

If they are left in a damaged condition, the unit may fall and result in injury.

Do not allow a child to mount on the unit or avoid placing any object on it.

Falling or tumbling may result in injury.

Do not let children play on and around the unit.

If they touch the unit carelessly, it may result in injury.

Do not place a flower vase and anything containing water.

Water may enter the unit, causing an electric shock or fire.

Never touch the internal parts of the controller.

Do not remove the front panel. Some parts inside are dangerous to touch, and a machine trouble may happen.

For checking and adjusting the internal parts, contact your dealer.

Avoid placing the controller in a spot splashed with water.

Water coming inside the machine may cause an electric leak or may damage the internal electronic parts.

Do not operate the air conditioner when using a room fumigation - type insecticide.

Failure to observe could cause the chemicals to become deposited in the unit, which could endanger the health of those who are hypersensitive to chemicals.

Safely dispose of the packing materials.

Packing materials, such as nails and other metal or wooden parts, may cause stabs or other injuries.

Tear apart and throw away plastic packaging bags so that children will not play with them. If children play with a plastic bag which was not torn apart, they face the risk of suffocation.

Do not turn off the power immediately after stopping operation.

Always wait at least five minutes before turning off the power. Otherwise, water leakage and trouble may occur.

The appliance is not intended for use by young children or infirm persons without supervision.

The remote controller should be installed in such away that children cannot play with it.

NOTE

Never press the button of the remote controller with a hard, pointed object.

The remote controller may be damaged.

Never pull or twist the electric wire of the remote controller.

It may cause the unit to malfunction.

Do not place the controller exposed to direct sunlight.

The LCD display may get discolored, failing to display the data.

Do not wipe the controller operation panel with benzine, thinner, chemical dustcloth, etc.

The panel may get discolored or the coating peeled off. If it is heavily dirty, soak a cloth in water-diluted neutral detergent, squeeze it well and wipe the panel clean. And wipe it with another dry cloth.

Dismantling of the unit, treatment of the refrigerant, oil and eventual other parts, should be done in accordance with the relevant local and national regulations.

1 NAMES AND FUNCTIONS

“UNDER HOST COMPUTER INTEGRATED CONTROL” LAMP
When this lamp turns on, no other operations are possible.

GROUP NO.

ROOM NAME INDICATION PLATE
Refer to the “2. PUTTING ROOM NAME INDICATION STICKER”

UNIFIED OPERATION/STOP BUTTON
Starts/stops all indoor units.

OPERATION LAMP
Turns on during operation of each group and flashes during malfunction stop.

INDIVIDUAL OPERATION/STOP BUTTON
Starts/stops each indoor unit group individually.

«(NOTE)»

- When using unified ON/OFF controller with other optional controllers for centralized control, “OPERATION LAMP” of the equipment which is not operated may turn on or off after several minutes. This state occurs due to signal communications and is not a failure.
- Do not open the upper part of remote controller except when rewriting the indication sticker or selecting control modes.

2 PUTTING ROOM NAME INDICATION STICKER

- Open the upper part of remote controller.
Insert a (-) screwdriver into the recess between the upper and lower part of remote controller (at 2 locations) and twist the screwdriver lightly.

PC board is attached both the upper and lower part of remote controller. Do not damage the board with the screwdriver.

- Pull out the room name indication plate.
Insert the point of a mechanical pencil etc. into the hole of the indication sticker to pull it out.

Control mode selector (DS2)

- Put the attached indication sticker on the room name indication plate.

In case of serial type indication sticker: Put the sticker aligning the lines of the sticker with those of the plate.

In case of individual type indication sticker: Put the sticker on the center of the frame. Write the room name in the frame of the sticker with a ball point pen or a felt-tip pen (oil-base).

- Reinstall the plate as it were, with checking the correct direction.
- Close the upper part of remote controller.

3 SELECTING CONTROL MODES

The following four patterns of control mode can be set.

Control mode	Individual	Centralized	Timer operation possible by remote controller	ON/OFF control impossible by remote controller
Content	Operation/stop is controlled by both unified ON/OFF controller and remote controller.	After operated by unified ON/OFF controller, operation/stop is freely controlled by remote controller until stopped by unified ON/OFF controller.	When used in conjunction with schedule timer, operation/stop is controlled freely by remote controller during the set time but operation is not available when schedule timer is ON.	Operation/stop is controlled by unified ON/OFF controller only. Indoor units can not be operated/stopped by remote controller.
DS2 setting				

NOTE:

- indicates the position of switches.
- Set control modes before turning power supply on.
- When used in conjunction with central remote controller, the control modes of the central remote controller has the priority.

4 DISPLAY OF MALFUNCTION

Flashing of lamps indicates malfunctions. Contact your Daikin dealer.
When turning power supply on, all lamps may light and UNDER HOST COMPUTER INTEGRATED CONTROL lamp may flash and not accept the operation for about on minute. These conditions are not malfunctions.

States of lamps	Contents of malfunctions
Flashing of operation lamp	Indicates malfunctions in the indoor unit in the group where the operation lamp is flashing.
Flashing of UNDER HOST COMPUTER INTEGRATED CONTROL lamp	Indicates malfunctions in optional controllers for centralized control.

13.11 <DST301BA61> Schedule Timer Controller

Enables you to connect and control weekly schedule for up to 128 indoor units all together.



- Simultaneous control of up to 128 indoor units is managed by a week schedule.
- The start and stop time for twice a day can be set for the week in increments of 1 minute.
- By combining with a central remote controller and schedule timer, you can construct a system that matches the size and use of the building.
- If used together with a central remote controller, you can set up to 8 schedule patterns which can be distributed among zones as desired using the central remote controller.
- Is equipped with a compensation function for power failure up to 48 hours.
- Features thin design of a mere 16 mm in thickness. (Uses JIS recessed box for 2.)
- Wiring can be up to 1 km in length. Applicable wiring methods include bus and star in addition to crossover type.
- Can be used in combination with other D-BACS equipment.

Specifications / Dimensions

SPECIFICATIONS

■ Specifications

Display of time	12-hour digital display
Clock cycle type	Quartz clock type
Clock accuracy	Within ± 30 sec./month (environmental temperature from 15°C to 35°C)
Timer programming	Two pairs of programmed time for both system start and system off can be set in units of minute for each day of the week
Power failure compensation time	Approximately 48 hours for a single occurrence of power failure (clock with No. of programmed time)
Size	120 (W) \times 120 (H) \times 53 (D) mm (Width/Height/Depth)
Weight	Approximately 210g

■ Outline drawings

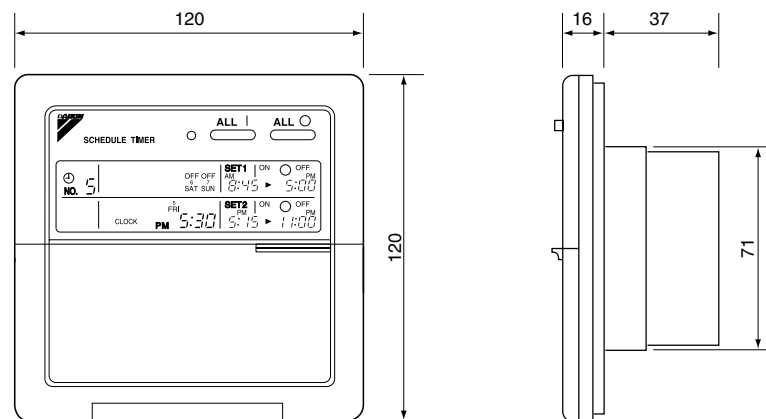

Specifications and appearance subject to change without notice.

13.12 <DST301BA61> Schedule Timer Controller Installation Manual

Please read these "SAFETY CONSIDERATIONS" carefully before installing air conditioning equipment and be sure to install it correctly. After completing the installation, make sure that the unit operates properly during the start-up operation. Please instruct the customer on how to operate the unit and keep it maintained. Also, inform customers that they should store this installation manual along with the operation manual for future reference. This air conditioner comes under the term "appliances not accessible to the general public".

Meaning of warning, caution and note symbols.

- ⚠ **WARNING** Indication a potentially hazardous situation which, if not avoided, could result in death or serious injury.
- ⚠ **CAUTION** Indication a potentially hazardous situation which, if not avoided, may result in minor or moderate injury. It may also be used to alert against unsafe practices.
- ⚠ **NOTE** Indication situation that may result in equipment or property-damage-only accidents.

⚠ WARNING

Ask your dealer or qualified personnel to carry out installation work. Do not try to install the machine by yourself.
Improper installation may result in water leakage, electric shocks or fire.

Perform installation work in accordance with this installation manual.
Improper installation may result in water leakage, electric shocks or fire.

Be sure to use only the specified accessories and parts for installation work.
Failure to use the specified parts may result in water leakage, electric shocks, fire or the unit falling.

Carry out the specified installation work after taking into account strong winds, typhoons or earthquakes.
Improper installation work may result in the equipment falling and causing accidents.

Make sure that a separate power supply circuit is provided for this unit and that all electrical work is carried out by qualified personnel according to local laws and regulations and this installation manual.
An insufficient power supply capacity or improper electrical construction may lead to electric shocks or fire.

Make sure that all wiring is secured, the specified wires are used, and no external forces act on the terminal connections or wires.
Improper connections or installation may result in fire.

When wiring the power supply and connecting the remote controller wiring and transmission wiring, position the wires so that the electric parts box lid can be securely fastened.
Improper positioning of the electric parts box lid may result in electric shocks, fire or the terminals overheating.

Before touching electrical parts, turn off the unit.

Ground the air conditioner. Do not connect the ground wire to gas or water pipes, lightning rod or a telephone ground wire.
Incomplete grounding may result in electric shocks.

When installing or relocating the system, be sure to keep the refrigerant circuit free from substances other than the specified refrigerant (R410A), such as air.

Do not reconstruct or change the settings of the protection devices.
If the pressure switch, thermal switch, or other protection device is shorted and operated forcibly, or parts other than those specified by Daikin are used, fire or explosion may result.

Do not touch the switch with wet fingers.
Touching a switch with wet fingers can cause electric shock.

Install an earth leak circuit breaker, as required.
If an earth leak circuit breaker is not installed, electric shock may result.

Do not install the air conditioner or the remote controller in the following locations:

- (a) where a mineral oil mist or an oil spray or vapor is produced, for example in a kitchen
Plastic parts may deteriorate and fall off or result in water leakage.
- (b) where corrosive gas, such as sulfurous acid gas, is produced
Corroding copper pipes or soldered parts may result in refrigerant leakage.
- (c) near machinery emitting electromagnetic waves
Electromagnetic waves may disturb the operation of the control system and result in a malfunction of the equipment.
- (d) where flammable gases may leak, where there are carbon fiber or ignitable dust suspensions in the air, or where volatile flammables such as thinner or gasoline are handled.
Operating the unit in such conditions may result in fire.

CISPR 22 Class A Warning.

This is a class A product. In a domestic environment this product may cause radio interference in which case the user may be required to take adequate measures.

⚠ CAUTION

Be very careful about product transportation.

Safely dispose of the packing materials.

Packing materials, such as nails and other metal or wooden parts, may cause stabs or other injuries. Tear apart and throw away plastic packaging bags so that children will not play with them. If children play with a plastic bag which was not torn apart, they face the risk of suffocation.

Do not turn off the power immediately after stopping operation.

Always wait at least five minutes before turning off the power. Otherwise, water leakage and trouble may occur.

⚠ NOTE

Install the indoor and outdoor units, power supply wiring and connecting wires at least 3.5ft. away from televisions or radios in order to prevent image interference or noise.

(Depending on the radio waves, a distance of 3.5ft. may not be sufficient enough to eliminate the noise.)

Remote controller (wireless kit) transmitting distance can result shorter than expected in rooms with electronic fluorescent lamps. (inverter or rapid start types)

Install the indoor unit as far away from fluorescent lamps as possible.

This unit is a class A product.

In a domestic environment this product may cause radio interference in which case the user may be required to take adequate measures.

Dismantling of the unit, treatment of the refrigerant, oil and eventual other parts, should be done in accordance with the relevant local and national regulations.

1 ACCESSORIES

Check the following accessories are included in the kit before installation.

Body	1	Installation screws (M4 × 16)	2
Operation manual	1	Attached electric wire (for individual use)	1
Installation manual*	4	Crimp style terminal (for individual use)	2

For Installation, a electrical box to be embedded is necessary (part to be procured in the field/with covers).

* DST301BA61 includes only one installation manual.

2 INSTALLATION AND INITIAL SETTING

1. Remove the upper part of the remote controller.

- Insert a (-) screwdriver (2 locations) into the recess between the upper part and the lower part of the remote controller and twist the screwdriver lightly.

(The PC board is attached with the upper part of the remote controller. Do not damage electric parts with a screwdriver, etc.)

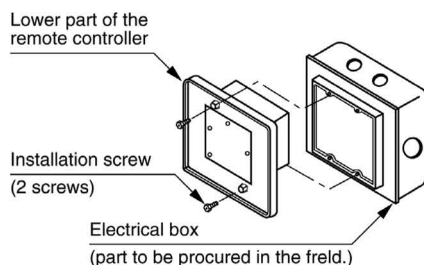
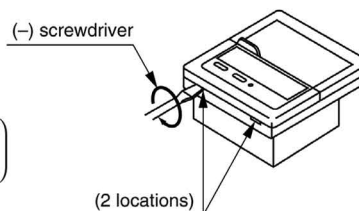

- Attach the lower part to the electrical box (part to be procured in the field) with the provided installation screws.

(Select a flat face as a installation place. Do not tighten the installation screws excessively not to damage the lower part of the remote controller.)

For part to be procured in the field electrical box, use KJB212AA (optional accessory).

2. Initial setting

① Setting connector for individual use (X1A) (Factory set : OFF) (Set for individual use only)

- For individual use of schedule timer
Insert the connector attached with the body case on the PC board.
- For combined use with other optional controllers for centralized control
Do not change the factory setting.

② Control mode selector (SS2) (Set for individual use only)

By changing the switch, setting mode of individual and centralized operation is available.

Note) When used with other optional controllers, control mode of central remote controller and unified ON/OFF controller have the priority.

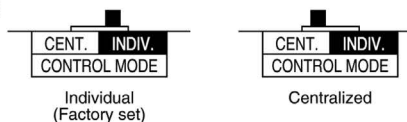

③ Setting of the sequential operation function

The schedule timer is equipped with a sequential operation function that sequentially turns indoor units on in 2-second intervals during unified operation.

(Sequential operation is factory set to "ON.")

To switch sequential operation ON or OFF, set as follows.

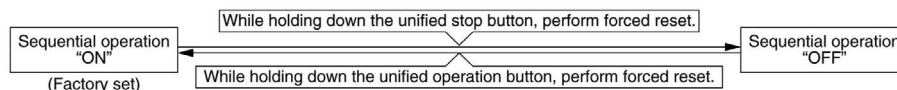

Note) The sequential operation function is designed to reduce the load on the power supply equipment, but does not guarantee that compressors will not be started simultaneously. You cannot therefore count on a capacity reduction effect by power supply equipment breaker selection.

④ Forced reset switch (SS1)

When changing the setting of the connector for individual use, etc., the switch can be reset simply by setting it to the reset side once and returning to the normal side. This procedure enables to reset without turning off the power. (Set the normal side at normal operation.)

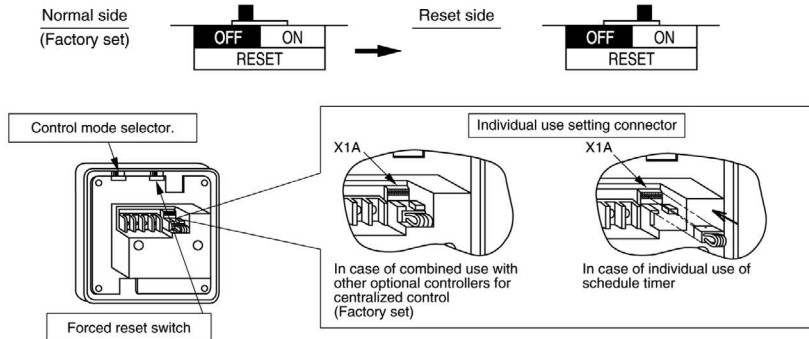

⑤ Setting for special function

When you want to have a programmed operation of a part of indoor units by using only schedule timer, cut off JP1 and supply the power again. You can have a programmed operation of the indoor units set the address for central control by local remote controller.

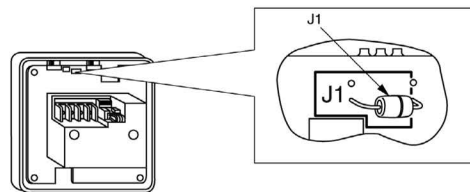

3. Transmission wiring

- In case of individual use of schedule timer
Connect terminals of the schedule timer (F1, F2) with terminals of the indoor unit (F1, F2). Connect terminals of the schedule timer (D1, D2) and the connector on the indoor unit PC board, using the attached electric wire and crimp style terminals. Prevent the connection part of crimp style terminal from getting out of the electric parts box of indoor unit.
- In case of combined use with other optional controllers for centralized control
Connect terminals of the schedule timer (F1, F2, D1, D2) and the terminals of the central remote controller (or unified ON/OFF controller).

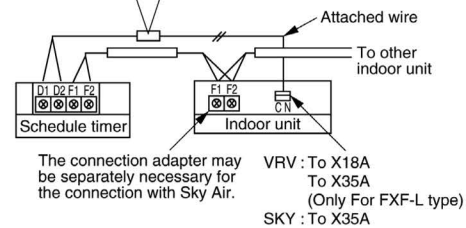
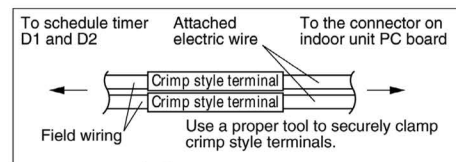

Wiring specifications

	F1, F2	D1, D2
Wiring	Sheathed wire (2-wire)	Sheathed wire (2-wire)
Gauge	0.75 ~ 1.25mm ²	0.75 ~ 1.25mm ²
Length	Max. 1000m	Max. 150m

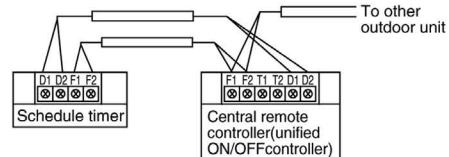

NOTES:

- Electrical box and transmission wiring are not attached.
- Do not touch the PC board with your hand.
- Keep transmission wiring at least 50 mm away from power supply wiring to avoid malfunctions.

4. Install the upper part of the remote controller as before.

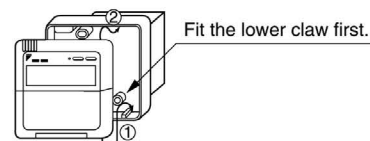

3 SETTING GROUP NO. FOR CENTRALIZED CONTROL

Set the group number of each group of the indoor unit from the remote controller. (In case of no remote controller, also connect the remote controller and set the group No. Then, remove the remote controller.)

- (1) Turn ON the power of the indoor unit and SCHEDULE TIMER.
(Unless the power is ON, no setting can be made.)
Check that the installation and electrical wiring are correct before turning the power supply ON.
(When the power supply is turned ON, all LCD appear once and the unit may not accept the operation for about one minute with the display of "88".)

- (2) While in the normal mode, hold down the "TEST" button for a minimum of 4 seconds.
The remote controller will enter the FIELD SET MODE.

- (3) Select the MODE No. "00" with the "MODE" button.

- (4) Use the "GROUP NO." button to select the group No. for each group.

(Group numbers increase in the order of
1-00,1-01,...1-15, 2-00,...8-15.)

- (5) Press "OK" to set the selected group No.
- (6) Press "TEST" to return to the NORMAL MODE.

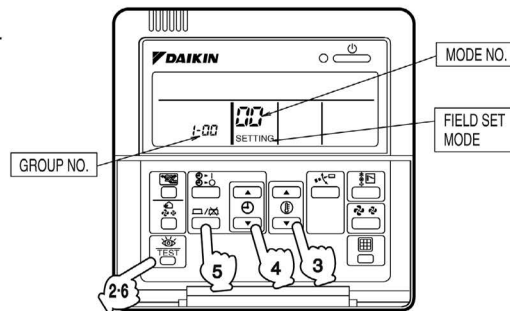

- NOTES)
- In case of individual use of schedule timer
Group number setting is not necessary. It is automatically set when turning power supply ON.
 - See the instruction manuals which came with the VentiAir and adapters (i.e., multi-purpose adapters) for details on their Group No. settings.

NOTICE Be sure to keep the operation manual for maintenance.

4 TEST OPERATION

Refer to the installation manual attached to the outdoor unit.

In case the schedule timer is used individually and the wiring is changed after the system has been operated, reset the power after energizing for more than five minutes.
It may not be possible to control the unit from the schedule timer.

13.13 <DST301BA61> Schedule Timer Controller Operation Manual

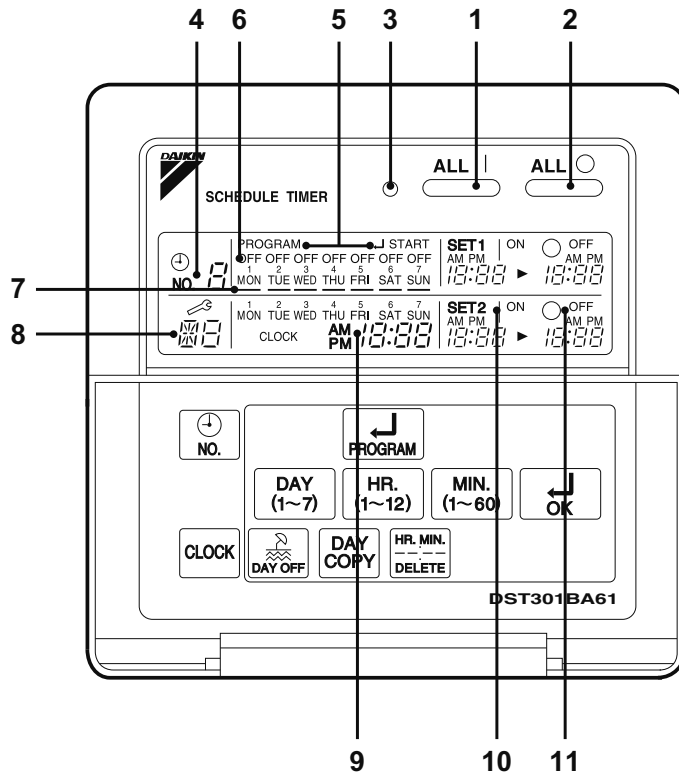

1

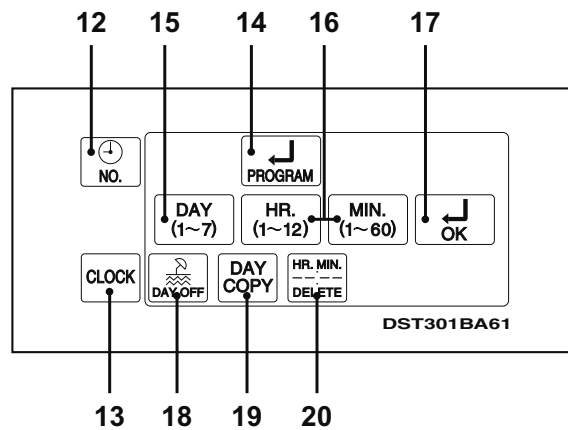

2

[1]

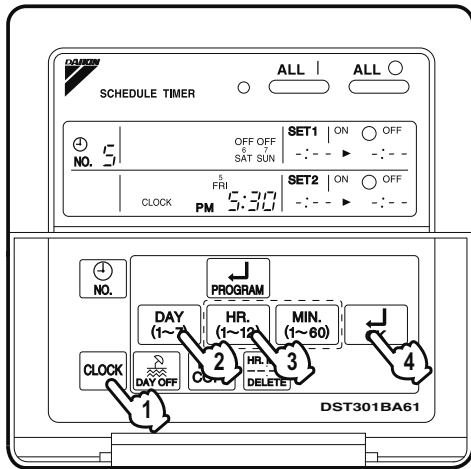

3

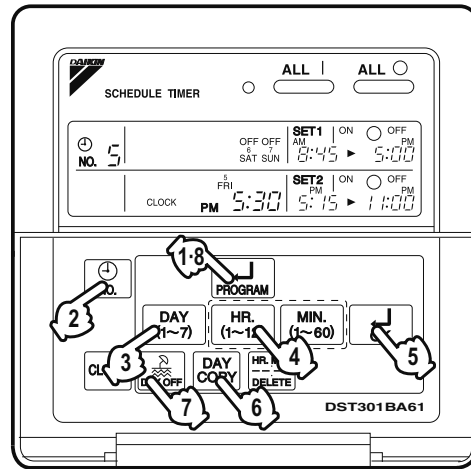

4

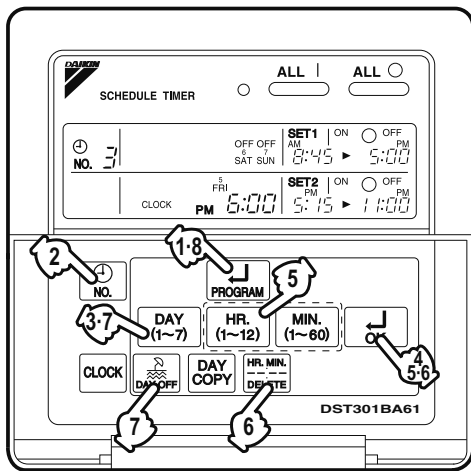

5

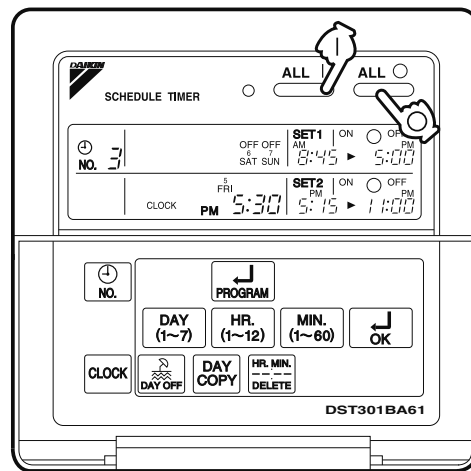

6

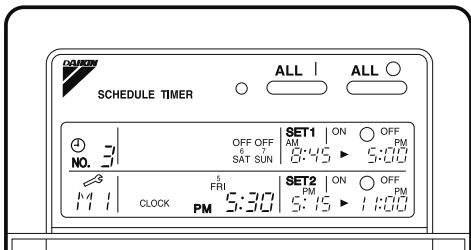

7

[2]

SAFETY CONSIDERATIONS

Please read these " SAFETY CONSIDERATIONS " carefully before installing air conditioning equipment and be sure to install it correctly. After completing the installation, make sure that the unit operates properly during the start-up operation.

Please instruct the customer on how to operate the unit and keep it maintained.

Also, inform customers that they should store this installation manual along with the operation manual for future reference.

This air conditioner comes under the term " appliances not accessible to the general public ".

Meaning of warning, caution and note symbols.

 **WARNING** Indicates a potentially hazardous situation which, if not avoided, could result in death or serious injury.

 **CAUTION** Indicates a potentially hazardous situation which, if not avoided, may result in minor or moderate injury. It may also be used to alert against unsafe practices.

 **NOTE** Indicates situation that may result in equipment or property-damage-only accidents.

Keep these warning sheets handy so that you can refer to them if needed.

Also, if this equipment is transferred to a new user, make sure to hand over this operation manual to the new user.

 **WARNING** —————

In order to avoid electric shock, fire or injury, or if you detect any abnormality such as smell of fire, turn off power and call your dealer for instructions.

Ask your dealer for installation of the air conditioner.

Incomplete installation performed by yourself may result in a water leakage, electric shock, and fire.

Ask your dealer for improvement, repair, and maintenance.

Incomplete improvement, repair, and maintenance may result in a water leakage, electric shock, and fire.

Improper installation or attachment of equipment or accessories could result in electric shock, short-circuit, leaks, fire or other damage to the equipment. Be sure only to use accessories made by Daikin which are specifically designed for use with the equipment and have them installed by a professional.

Ask your dealer to move and reinstall the air conditioner or the remote controller.

Incomplete installation may result in a water leakage, electric shock, and fire.

Never let the indoor unit or the remote controller get wet.

It may cause an electric shock or a fire.

Never use flammable spray such as hair spray, lacquer or paint near the unit.

It may cause a fire.

Never replace a fuse with that of wrong ampere ratings or other wires when a fuse blows out.

Use of wire or copper wire may cause the unit to break down or cause a fire.

Never inspect or service the unit by yourself.

Ask a qualified service person to perform this work.

Cut off all electric waves before maintenance.

Do not wash the air conditioner or the remote controller with excessive water.

Electric shock or fire may result.

Do not install the air conditioner or the remote controller at any place where flammable gas may leak out.

If the gas leaks out and stays around the air conditioner, a fire may break out.

Do not touch the switch with wet fingers.

Touching a switch with wet fingers can cause electric shock.

CISPR 22 Class A Warning:

This is a class A product. In a domestic environment this product may cause radio interference in which case the user may be required to take adequate measures.

— CAUTION —

After a long use, check the unit stand and fitting for damage.

If they are left in a damaged condition, the unit may fall and result in injury.

Do not allow a child to mount on the unit or avoid placing any object on it.

Falling or tumbling may result in injury.

Do not let children play on and around the unit.

If they touch the unit carelessly, it may result in injury.

Do not place a flower vase and anything containing water.

Water may enter the unit, causing an electric shock or fire.

Never touch the internal parts of the controller.

Do not remove the front panel. Some parts inside are dangerous to touch, and a machine trouble may happen.

For checking and adjusting the internal parts, contact your dealer.

Avoid placing the controller in a spot splashed with water.

Water coming inside the machine may cause an electric leak or may damage the internal electronic parts.

Do not operate the air conditioner when using a room fumigation - type insecticide.

Failure to observe could cause the chemicals to become deposited in the unit, which could endanger the health of those who are hypersensitive to chemicals.

Safely dispose of the packing materials.

Packing materials, such as nails and other metal or wooden parts, may cause stabs or other injuries.

Tear apart and throw away plastic packaging bags so that children will not play with them. If children play with a plastic bag which was not torn apart, they face the risk of suffocation.

Do not turn off the power immediately after stopping operation.

Always wait at least five minutes before turning off the power. Otherwise, water leakage and trouble may occur.

The appliance is not intended for use by young children or infirm persons without supervision.

The remote controller should be installed in such way that children cannot play with it.

— NOTE —

Never press the button of the remote controller with a hard, pointed object.

The remote controller may be damaged.

Never pull or twist the electric wire of the remote controller.

It may cause the unit to malfunction.

Do not place the controller exposed to direct sunlight.

The LCD display may get discolored, failing to display the data.

Do not wipe the controller operation panel with benzine, thinner, chemical dustcloth, etc.

The panel may get discolored or the coating peeled off. If it is heavily dirty, soak a cloth in water-diluted neutral detergent, squeeze it well and wipe the panel clean. And wipe it with another dry cloth.

Dismantling of the unit, treatment of the refrigerant, oil and eventual other parts, should be done in accordance with the relevant local and national regulations.

CONTENTS

SAFETY CONSIDERATIONS	1	Change and cancellation of no. of programmed time.....	7
FEATURES AND FUNCTIONS	3	Manual operation	9
NAMES AND FUNCTIONS OF OPERATING SECTION.....	4	Operation control code	9
OPERATION.....	5	Error diagnosing function.....	9
Setting present time	5	QUESTION AND ANSWER	10
Setting no. of programmed time.....	6	SPECIFICATIONS	12
		Specifications.....	12
		Outline drawings.....	12

FEATURES AND FUNCTIONS

■ Operation controlled by programmed time

Operating time and stopping time can be set to the minute by each day of the week. The operating and stopping patterns can also be set in schedule according to the time slot given twice a day in tune with the uses.



See page
5—9.

■ Unified Operation/Stop

By using this schedule timer, the unified operation/stop of the indoor unit can be executed manually regardless of the No. of programmed time in operation.



















See page
9.

• When used in conjunction with central remote controller (Optional Accessory)

The operation controlled by programmed time can be set for up to eight different patterns (timer No. 1 – 8). Each schedule pattern can be also selected.

NAMES AND FUNCTIONS OF OPERATING SECTION (Fig. 1, 2)

1	UNIFIED OPERATION BUTTON “ ALL ” 	Press this button to perform the unified operation regardless of the No. of programmed time.	9	DISPLAY “ <small>MÓN TUE WED THU FRI SAT SUN</small> CLOCK <small>AM PM</small> 12:00 ” (PRESENT TIME)	Displays the present day of the week and time.
	2			UNIFIED STOP BUTTON “ ALL ○ ” 	
3	OPERATION LAMP (RED)	The light turns on during the operation of the indoor unit.	11	DISPLAY “ <small>OFF</small> 12:00 ” (PROGRAMMED TIME OF SYSTEM OFF) AM PM	Displays the time programmed to stop.
4	DISPLAY “ <small>NO. 8</small> ” (TIME NO.) 	Displays the time No. only when used in conjunction with the central remote controller.	12	TIME NO. BUTTON “ <small>NO.</small> ” 	See page 5–9.
5	DISPLAY “PROGRAM ↵ START.” (PROGRAMMING START) 	The light turns on when the timer is programmed.	13	CLOCK ADJUSTING BUTTON “ CLOCK ” 	Press this button to set the present time.
6	DISPLAY “ OFF ” (HOLIDAY SETTING) 	Lights above the day of the week set as holiday. The operation controlled by timer is not available on that day.	14	PROGRAMMING START BUTTON “  ” PROGRAM	Press this button to set or check the No. of programmed time. Press it again after you are through with the program.
7	DISPLAY “ — ” (SETTING OF DAYS OF A WEEK) 	Flashes below the day of the week programmed.	15	BUTTON FOR SELECTING DAYS OF A WEEK “  ”	Press this button to select the day of the week.
8	DISPLAY “  ” (MALFUNCTION CODE)	Displays the contents of malfunction during the stop due to malfunction.	16	HOUR/MINUTE BUTTON “   ”	Press this button to adjust the present time and the programmed time.

17	TIMER ON BUTTON “  ”
	Press this button to set the present time and the programmed time.
18	HOLIDAY SETTING BUTTON “  ”
	Press this button to set holidays.
19	BUTTON FOR COPYING PROGRAM OF PREVIOUS DAY “  ”
	Use this button to set the No. of programmed time same as that of the previous day.
20	PROGRAM CANCELING BUTTON “  ”
	Use this button to set the programmed time to cancel. The display shows “-;--”.
(Note) 1. Please note that all the displays in the figure appear for explanation purpose or when the cover is open.	

OPERATION

■ Setting present time (Fig. 3)

(Example) In case of setting Friday, 5:30 p.m.

1.  Press the **CLOCK ADJUSTING BUTTON**. The present time display flashes.

(NOTE)

- The present time needs adjusting in case of turning power supply on for the first time or the occurrence of power failure over the period of 48 hours or more.

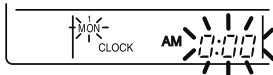

2.  Press the **BUTTON FOR SELECTING DAYS OF A WEEK**. Each time the button is pressed, the day display shifts to the right.

(NOTE)

- The display “ MON ” follows the display “ SUN. ”

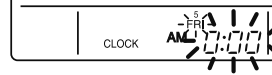

Set the day to Friday.

3.  Set the time with the **HOUR/MINUTE BUTTON**. Each time the HOUR/MINUTE BUTTON is pressed, the display is put forward minute by minute and hour by hour. When the button is kept pressed, the display is put forward continuously.

(NOTES)

- After becoming “ AM 11:00 ”, when the button is pressed, the display becomes “ PM 0:00 ”.
- After becoming “ 59 ” (minute), when the button is pressed, the display becomes “ 00 ” (minute).

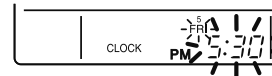

Set the time to 5:30 p.m.

4.  Press the **TIMER ON BUTTON** the moment the time signal of TV, radio, telephone, etc. is heard. The mark “ : ” flashes, and the clock starts.

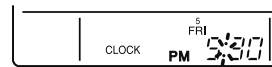

Press the **TIMER ON BUTTON** in tune with the time signal at 5:30 p.m.

(NOTES)

- The clock used is of 12-hour type.
- When you turn power supply on, the system may display “ 88 ” for about one minute and not start to operate after all the liquid crystal displays appear at a time.
- If the **CLOCK ADJUSTING BUTTON** is pressed by mistake, press it again to return to the original state. As the clock does not stop, the time indicated by the clock is kept correct. In case of power failure within 48 hours, the clock keeps operating by utilizing the built-in battery.

■ Setting no. of programmed time (Fig. 4)

(Example) Time No. 5 (to be programmed only when used in conjunction with the central remote controller)

Monday to Friday:

Operating from 8:45 a.m. till 5:00 p.m.

Operating from 5:15 p.m. till 11:00 p.m.

Saturday and Sunday:

Setting the whole day stop operation (application for holidays) controlled by programmed time.

1. Press the PROGRAMMING START BUTTON. Programming is available. The display "PROGRAM J START" appears, and the display of days of a week flashes.

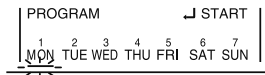

2. Press the TIME No. BUTTON, and select the desired number.

(NOTE)

- Unless used in conjunction with the central remote controller, The TIME No. is not displayed and can not be selected.

Select the TIME No. 5.

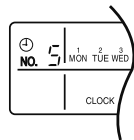

3. Press the BUTTON FOR SELECTING DAYS OF A WEEK, and set the proper day of the week. Each time you press it, the flashing display of days of a week shifts to the right.



Set to Monday.

(1) Setting programmed time

4. Set the programmed time of system start 1 by using the HOUR/MINUTE BUTTON. Each time the HOUR/MINUTE BUTTON is pressed, the display is put forward minute by minute and hour by hour. When the button is kept pressed, the display is put forward continuously.



Set the "PROGRAMMED TIME OF SYSTEM START 1" at 8:45 a.m.

5. Press the TIMER ON BUTTON, and set the programmed time of system start 1. Each time you press it, the next area to be set flashes.

(NOTE)

- Set the other programmed time in the same procedure.

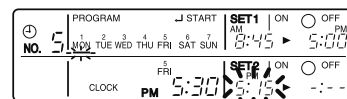
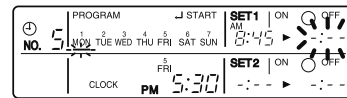

- (2) **Set the next day of the week.**
 Set the day of the week to Tuesday, and copy the program of the previous day (Monday). In the same procedure, set the day of the week to Wednesday through Friday in sequence.

6. **Press the BUTTON FOR SELECTING DAYS OF A WEEK and set the following day. Press the BUTTON FOR COPYING PROGRAM OF PREVIOUS DAY. The same program as that of the immediately preceding day of the week is set.**

(NOTE)

- Repeat each procedure 3 – 5 in the above when not copying the contents of the previous day.

- (3) **Holiday setting**

7. **Press the BUTTON FOR SELECTING DAYS OF A WEEK and set one or more days of the week as holiday. Press the HOLIDAY SETTING BUTTON, and the display “ OFF ” is displayed at the top of the day of the week. If you press it again, the display returns to the original state.**

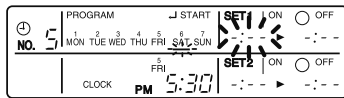

Set Saturday and Sunday as holidays.

8. **Press the PROGRAMMING START BUTTON, and finish the program setting.**

(NOTES)

- Unless the button is pressed within 20 minutes, the display will automatically revert back to the original state. In this case, setting contents up to the point where the TIMER ON BUTTON (or HOLIDAY SETTING BUTTON or BUTTON FOR COPYING PROGRAM OF PREVIOUS DAY) is pressed will only take effect.
- The display “ PROGRAM ↵ START ” and the display of days of a week “ — ” disappears.

- The flashing display goes off, and the No. of programmed time of the present day is displayed. Then the operation controlled by timer starts.
- The operation controlled by timer is executed even while the program is being set.



This is the end of the setting example.

■ Change and cancellation of no. of programmed time (Fig. 5)

(Example) **Time No. 3 (to be set only when used in conjunction with the central remote controller)**

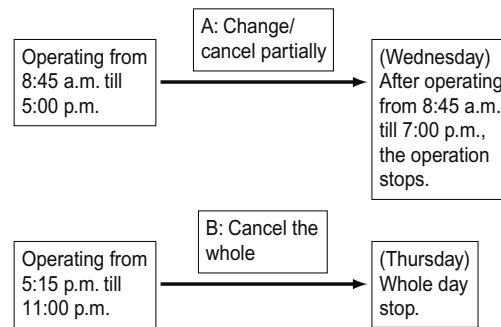

- Press the PROGRAMMING START BUTTON. The program setting is ready. The display “ PROGRAM ↵ START ” appears, and the display of days of a week flashes.**
- Press the TIME No. BUTTON, and select the desired No.**

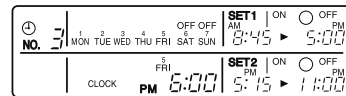

Select the time No. 3.

3.  Press the **BUTTON FOR SELECTING DAYS OF A WEEK**, and set the day of the week to be changed. The set No. of programmed time of the day of the week is displayed.

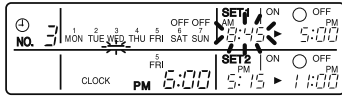

Set the day to Wednesday.

A. Change/cancel partially

4.  Press the **TIMER ON BUTTON** and change, and the display of programmed time flashes. Each time you press it, the next area to be set flashes.



Shift to the display "PROGRAMMED TIME OF SYSTEM OFF 1".

5.  Press the **HOUR/MINUTE BUTTON** and change the programmed time. Press the **TIMER ON BUTTON**, and finalize the setting of change.



Change the "PROGRAMMED TIME OF SYSTEM OFF 1" to 7:00 p.m.

6.  Press the **PROGRAM CANCELING BUTTON**, and cancel the programmed time. If you press it again, display returns to the original state. Press the **TIMER ON BUTTON** to finalize the cancellation.



Shift to the "PROGRAMMED TIME OF SYSTEM START 2".

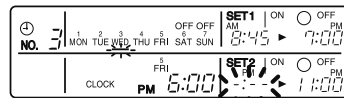

Set the "PROGRAMMED TIME OF SYSTEM START 2" to program cancellation.

In the same procedure, cancel the programmed time of system off 2.

B. Cancel the whole

7.  Press the **BUTTON FOR SELECTING DAYS OF A WEEK**, and shift to the day of the week to be canceled. Then, press the **HOLIDAY SETTING BUTTON**, the display "OFF" appears at the top of the particular day of the week. The programmed time is canceled. If you press the button again, the display returns to the original state.

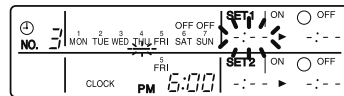

Shift the day of the week to Thursday to set as a holiday.



8.  Press the **PROGRAMMING START BUTTON**. The program setting is now finished.

(NOTES)

- Unless the button is pressed within 20 minutes, the display will automatically revert back to the original state. In this case, setting contents to the point where the **TIMER ON BUTTON** (or **HOLIDAY SETTING BUTTON** or **BUTTON FOR COPYING PROGRAM OF PREVIOUS DAY**) is pressed will only take effect.
- To continue the change/cancellation, do not press the **PROGRAMMING START BUTTON** until all change/cancellation are completed.
- The operation controlled by timer is executed even while the program is being set.

■ Manual operation (Fig. 6)

This schedule timer enables the operation/stop by pressing the **UNIFIED OPERATION/STOP BUTTON** in addition to the operation controlled by timer (operation/stop according to the programmed time) at any time.

1.  Press the **UNIFIED OPERATION BUTTON**, and the **OPERATION LAMP** turns on.
2.  Press the **UNIFIED STOP BUTTON**, and the **OPERATION LAMP** is turned off.

(NOTES)

- The operation automatically stops according to the programmed time of system off even during the manual operation. In the meantime, the operation starts automatically according to the programmed time of system start even during the stop of operation.
- If the unit is used in conjunction with other optional controllers for centralized control, the **OPERATION LAMP** of the unit that is not under operation control may be turned on or off a few minutes behind schedule. This shows that the signal is being exchanged, and does not indicate any failure.

Operation lamp

- Turn on: The light turns on when any of the indoor units is in operation whether the operation is controlled by timer or by hand.
- Turn off: The light turns off when all the indoor units stop.

■ Operation control code

Two different types of operation control codes can be selected when this kit is used independently (when not used in conjunction with the central remote controller, unified ON/OFF controller, etc.).

Individual

In case where the operation/stop is controlled by both schedule timer and remote controller.

Centralized

The operation is controlled by the schedule timer alone, and the operation/stop is controlled freely with the remote controller during the programmed time.

(NOTES)

- For current settings, contact your DAIKIN dealer.
- To change settings, contact your DAIKIN dealer.
Do not change settings yourself.

■ Error diagnosing function (Fig. 7)



This schedule timer is provided with the malfunction diagnosing function. The malfunction code flashes if there occurs any malfunction in communication, etc. between and among the optional controllers for centralized control. In addition, the operation lamp also flashes if there occurs any malfunction in communication with the indoor unit. Check the contents of the display and contact your DAIKIN dealer because the signals give you the idea of the trouble area.

Operation lamp	Malfunction code	Contents of malfunction
Turn off	M1	Failure of PC board of schedule timer. Fixes The following causes are possible. Check each one. 1. PC board problems
Turn on or off	M8	Malfunction of transmission between each optional controllers for centralized control. Fixes Check all central devices which are connected (e.g., power supply, transmission wiring, etc.).
Turn on or off	MA	Improper combination of optional controllers for centralized control. Fixes The following causes are possible. Check each one. 1. Are all central devices combined correctly? 2. Is the master central connector attached to two or more central devices? 3. Are there 128 or more indoor units connected?

Turn on or off	MC	Address failure of schedule timer. Fixes The following causes are possible. Check each one. 1. Do the control range addresses in the central remote controller overlap? 2. Do the control range addresses in the on/off controller overlap? 3. Are there 2 or more schedule timers connected?
Flash	UE	Malfunction of transmission between indoor unit and optional controllers for centralized control. Fixes Inspect all indoor units which are displaying an error (e.g., power supply, transmission wiring, etc.).
Flash	—	Malfunction in indoor unit (Refer to the malfunction codes of the indoor remote controller, while also read the "CAUTION FOR SERVICING" attached to the indoor unit.)

QUESTION AND ANSWER

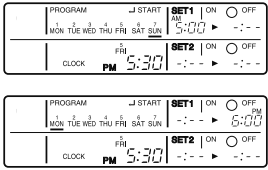



Question	Answer
It is possible to make settings twice a day, but is it possible to make only the "off" setting? (To avoid forgetting to turn the unit off.)	Yes. Press the PROGRAM CANCELING BUTTON in the "AM/PM ON 12:00" section in order to set it to "OFF".

<p>Is it possible to set times which straddle days?</p>	<p>Yes, it is possible. Example: Start operation at 5:00 a.m. on Sunday Stop operation at 6:00 p.m. on Monday</p> 	<p>The TIME NO. is not displayed.</p>	<p>The following causes are possible. 1. The TIME NO. is not displayed when using the schedule timer alone. (It can be set if using the central remote controller at the same time.)</p>
<p>The unit does not turn on even though the set "on" time has come. (When using the schedule timer alone)</p>	<p>The following causes are possible. 1. Are the "on" time and the "off" time set to the same time?</p>	<p>The display remains</p>  <p>even though I push the HOUR/MINUTE BUTTON in the timer program settings.</p>	<p>The following causes are possible. 1. Is the day set to a holiday?</p>
<p>The unit does not turn on even though the set "on" time has come. (When using the unit with a central remote controller)</p>	<p>The following causes are possible. Check each one. 1. Was the timer number set with the central remote controller? Was an incorrect timer number set? 2. Is another timer no. set with the central remote controller set for "off" at the same time? 3. Is the operation code set to "remote control permission timer" using the central remote controller or the on/off controller?</p>	<p>I cannot set "central management priority" or "after-push priority" with the schedule timer.</p>	<p>The following causes are possible. 1. Is a central remote controller or on/off controller also installed? * The priority order of the operation codes depends on the central devices which are installed. The below operation codes are set. • Schedule timer Central remote controller is used as well Operation code of the central remote controller • Schedule timer On/off controller is used as well Operation code of the on/off controller • Schedule timer Central remote controller On/off controller is used as well Operation code of the central remote controller</p>
<p>The unit operates even though that day is set as a holiday. (When using the unit with a central remote controller)</p>	<p>The following causes are possible. 1. Is another timer number set with the central remote controller set for "on" at the same time? (If two timer numbers are set, make sure that the settings for holidays and working days do not overlap between the different timer numbers.)</p>		

13.14 <KPW063B4> Air Direction Adjustment Grille

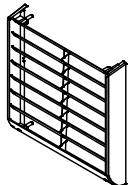
Component parts Be sure to check that the following parts are included before installation.

Component parts

Name	① Air direction adjustment grille	② Screw	③ Spacer	④ Installation Manual
Illustration				
Quantity	1 pcs.	4 pcs.	4 pcs.	1 sheet (this sheet)

Selection of installation site

Install only on an outdoor unit in a location that satisfies the following conditions:

- When installing the outdoor unit near the neighbouring house.
- Where you wish to change the exhaust airflow direction because the outdoor unit has been installed facing a road, so that passing people are not exposed to its exhaust air
- When changing the airflow direction to prevent exhaust blowing directly onto passersby or garden plants.

Cautions for usage

- Be sure to perform the following as installation precautions to ensure correct and safe use of the air direction adjustment grille.
 1. Install the product so that it is situated high enough to allow access to the outdoor unit for maintenance purposes.
 2. When installing the product in a location in which it may be exposed to strong winds, install a rollover prevention bracket (sold separately) at the same time.
 3. Tighten screws securely. Failure to do so may result in vibration.

1 Verifying the amount of space required for installation

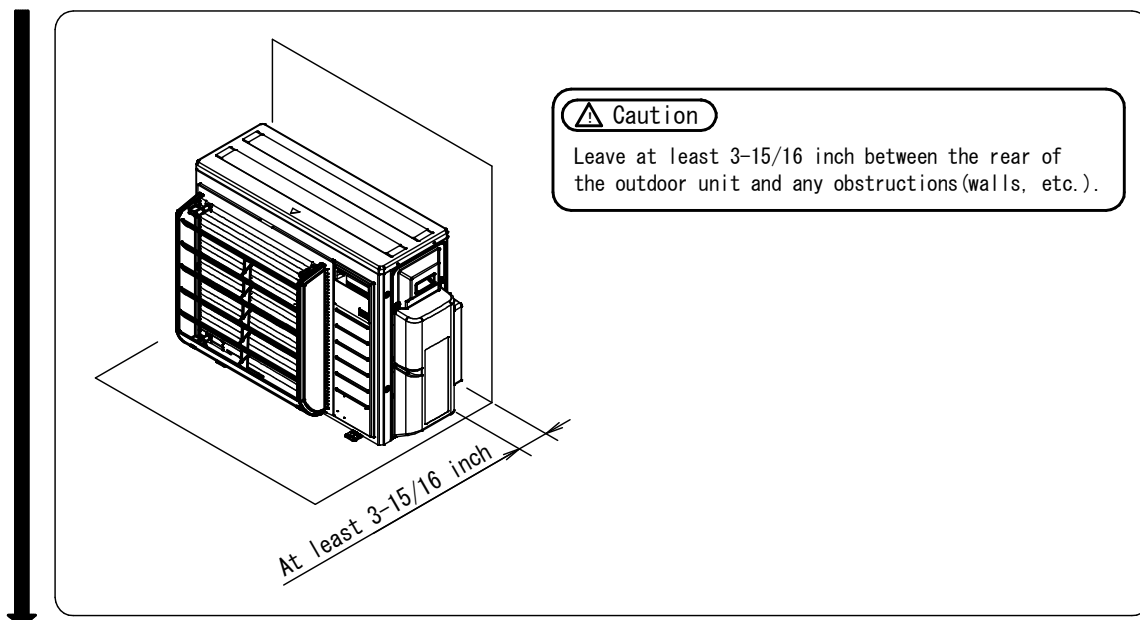

2 Installation of air direction adjustment grille

⚠ Caution

Install the air direction adjustment grille on top of the outlet grille.
Be sure to install the outlet grille as installing only the air direction adjustment grille would allow a person to reach his or her hand into the outdoor unit far enough to come into contact with the rotating fan.

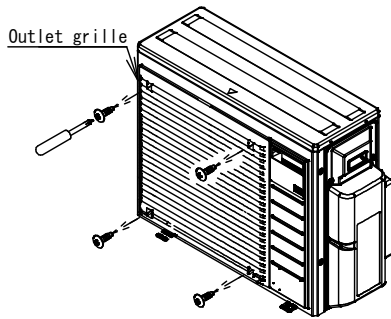

- (1) Remove the 4 outlet grille fixing screws.
 - (2) Referring to the following illustration, attach the outlet grille and air direction adjustment grille, taking care to align them with the air outlet direction.
- Attach the air direction adjustment grille on top of the outlet grille using the same screws.

Upward facing

Downward facing

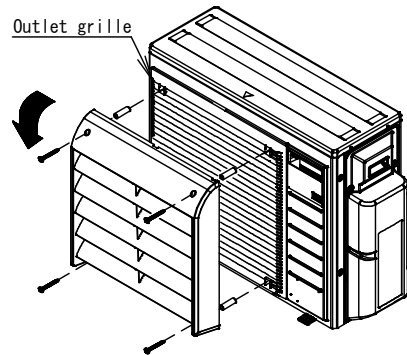
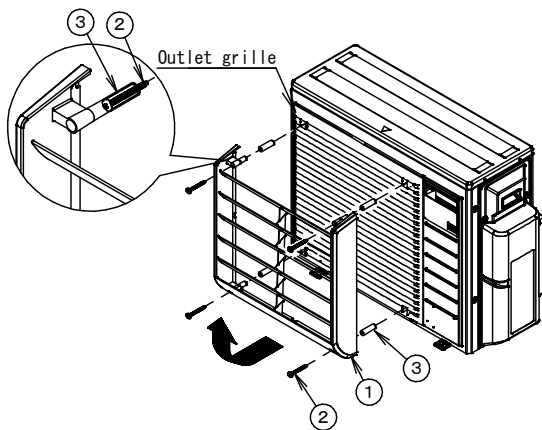

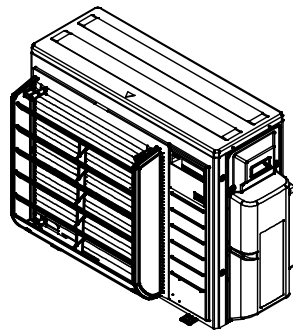

Appearance of the air direction adjustment grille after installation
(when installed with the louvers facing up)



13.15 <KKG063A42> Back Protection Wire Net

Component parts

Name	① Protection net	② Installation manual
Shape		
Q'ty	1pc.	1sheet (this sheet)

Caution

Be sure to wear protection gloves when performing installation work as the fins on the heat exchanger may cause injury.

Part names

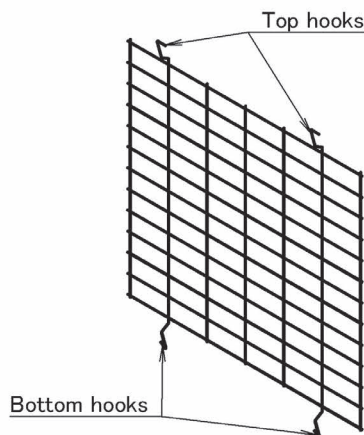

2 Attach the protection net (①)

Orient the protection net (①) so that top and bottom hooks are facing the heat exchanger and insert the two bottom hooks between the heat exchanger and the bottom frame.

Insert the two top hooks between the heat exchanger and the top panel while flexing the protection net (①).

※ Be careful not to damage the heat exchanger's cooling tubes.

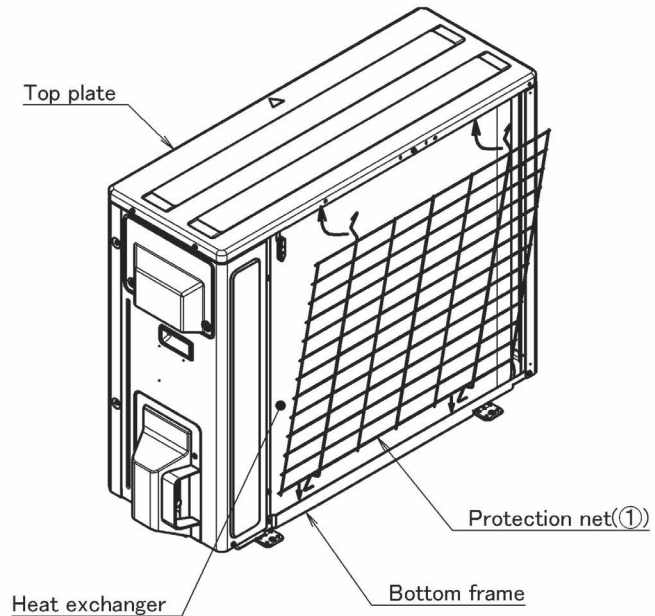

1 Verify the location at which the protection net (①) is to be installed.

Attach the protection net (①) so that the vertical grating is aligned with the edge of the installation leg on the right side of the outdoor unit.

Positioning line when installing the protection net (①)

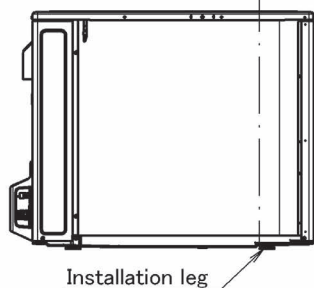

3 Appearance of the protection net (①) following installation

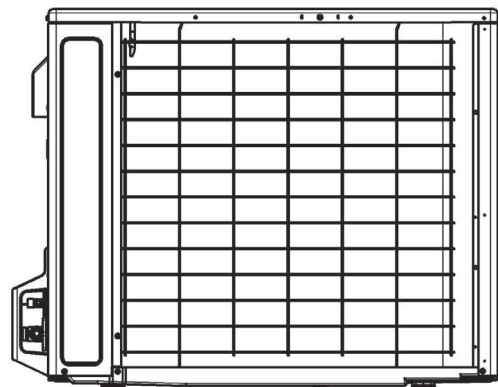



13.16 <KEH067A41EA, KEH063A4E, FTDBHML> Drain Pan Heater

Safety Considerations for Installation of Drain Pan Heater

Read these **Safety Considerations** carefully before installing the drain pan heater. After completing the installation, check if the unit operates properly during the start-up operation.

Meaning of **DANGER**, **WARNING** and **CAUTION** symbols.

 DANGER	Indicates an imminently hazardous situation which, if not avoided, will result in death or serious injury.	 CAUTION	Indicates a potentially hazardous situation which, if not avoided, may result in minor or moderate injury. It may also be used to alert against unsafe practices.
 WARNING	Indicates a potentially hazardous situation which, if not avoided, could result in death or serious injury.		

- Inform users that they should store this installation manual for future reference.
- After completing the installation, make sure that the unit operates properly during the startup operation.
- All phases of the field-installation, including, but not limited to, electrical, piping, and safety, must be done in accordance with manufacturer's instructions and must comply with national, state, provincial, and local codes.
- This product is a heater designed to melt snow that is blown into the product from the outside to prevent the drain pan of the outdoor unit from freezing.
- Install the product with a snow-break hood on a high stand if this product is used in heavy snow areas.

DANGER

- **Do not touch the heater unit without wearing gloves.**
The temperature of the heater unit will become high when the heater is turned on. Touching the heater unit with bare hands will result in burns or injury.







WARNING

- **Request the dealer or an authorized technician to install the product.**
Improper installation of the product could result in water leakage, an electric shock, or fire.
- **The product must be installed according to the instructions given in this manual.**
The incomplete installation of the product could result in water leakage, an electric shock, or fire.
- **Use the supplied or specified installation parts.**
Use of other parts could result in the unit becoming loose and falling, water leakage, electric shock, or fire.
- **Turn off the power supply at the time of installation.**
Touching any electrical parts may with the power supply turned on could result in electric shock.
- **Use specified wires. Connect and fix the wires so that the wires will not put improper force on the terminal junctions.**
Wires connected or fixed improperly could result in terminal overheating, an electric shock, or fire.
- **When wiring and connecting the indoor and outdoor units, carefully arrange the wiring so that they will not put improper force on the structures.**
Install covers over the wires. Incomplete cover installation could result in terminal overheating, an electric shock, or fire.

CAUTION

- **Wear protective gloves at the time of installation.**
Touching the suction mouth or aluminum fin of the outdoor unit may result in injury.
- **Do not install the product in places where there is danger of exposure to inflammable gas leakage.**
If the gas leaks and builds up around the unit, it may catch fire.
- **Do not grab the top plate of the outdoor unit carelessly when removing the top plate.**
The sharp edge of the top plate may cause injury.
- **Do not install the outdoor unit in places where small animals may nest in the outdoor unit.**
If small animals intrude and touch the internal parts of the outdoor unit, the outdoor unit may malfunction, generate smoke, or ignite. Advise the user to keep the place clean.
- **Do not touch the heater unit with bare hands.**
The temperature of the heater unit will become high when the heater is turned on. Touching the heater unit with bare hands may result in burns or injury.

Accessories

		KEH067A41E FTDBHMS	KEH063A4E FTDBHML		KEH067A41E FTDBHMS	KEH063A4E FTDBHML	
(A) Drain pan heater		1	1	(E) Installation manual (multi-language)		1	1
(B) M4 piercing screw		3	6	(F) Electric wiring diagram label		1	1
(C) Binding band		1	1	(G) Information label		1	1
(D) Sealing material		1	2	Appearance of the (A) drain pan heater may differ from some models.			

Tools Required for Installation

- Electric drill
- $\phi 1/8$ inch ($\phi 3.2$ mm) drill
- Phillips screwdriver
- Nippers

Installation Procedure (1)

⚠ WARNING

- Be sure to check that the power supply of the product is turned off.

Some stages in the installation procedure differ by model of outdoor unit. Refer to the instructions for the relevant model.

Type A models : RX09/12, RXN09/12, RXL09/12

Type B models : RX15/18/24, RXN18/24, RXL15

Type C models : 2/3/4MXS, 2/3MXL, RX30/36

1. Remove each component of the outdoor unit.

- 1) Remove the top plate.
- 2) Affix the (F) electric wiring diagram label where there is enough space available on the back of the top plate.
- 3) Remove the screws from the protective wire mesh if one is fitted. (2 screws)
(For type B and C models only)
- 4) Remove the front plate.
- 5) Remove the anti-drip cover.
(For type B and C models only)
- 6) Affix the (G) information label near the manufacturer's label.

- The appearance of the outdoor unit and the number of screws may differ from some models.
- Screw types for each component are indicated as below.

No icon: Hexagon tapping screw

△ : Truss head tapping screw

For type A models

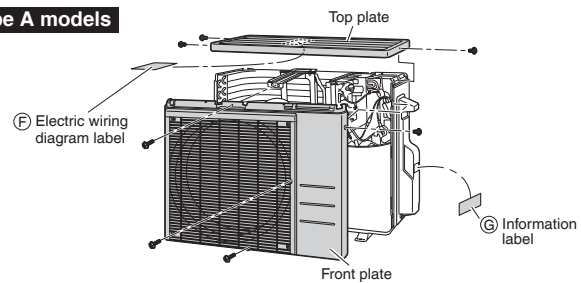

For type B and C models

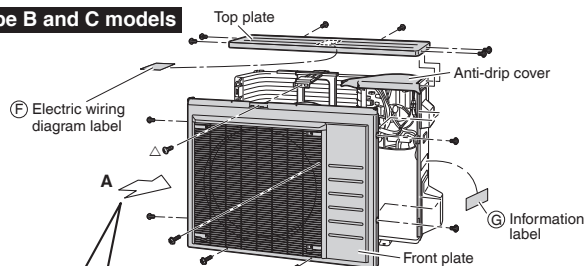

View A

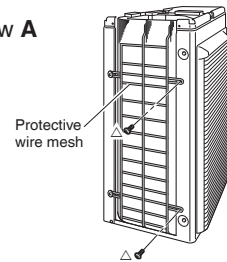

Installation Procedure (2)

2. Remove the fan motor base.

- 1) Remove the fixing screws at the lower section of the fan motor base. (2 screws)
- 2) Remove the fan motor base together with the propeller fan and ensure that stress is not placed on the propeller fan when placing them aside.
 - Do not remove the fan motor harness.
 - Ensure that the fan motor harness does not come into contact with the edges of the heat exchanger or other components.

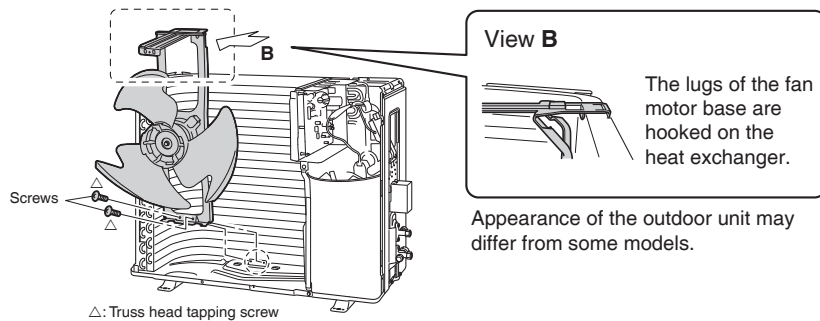

3. Install the drain pan heater.

⚠ CAUTION

- When drilling a hole, be careful not to damage the soundproofing material and other components on the back side.

For details, refer to “**Installation Procedure (3)**” also.

- 1) Remove 1 screw from the bottom frame so that the plates of the Ⓐ drain pan heater can be inserted under the heat exchanger with ease.
- 2) Lift up the heat exchanger, and insert the plates of the Ⓐ drain pan heater under the heat exchanger.
 - The ground plate of the Ⓐ drain pan heater should be installed so that, in type A models, it firmly adheres to the bottom frame and, in type B and C models, it firmly adheres to the partition plate.
 - Install the Ⓐ drain pan heater in a position where it does not come into contact with the fan motor base.
- 3) If there are no holes, drill $\phi 1/8$ inch ($\phi 3.2$ mm) holes in the bottom frame and the partition plate to fix the Ⓐ drain pan heater.
 - Place the actual components to ensure positioning is correct before drilling holes.
 - The holes can be made with the included piercing-screw as well.
- 4) Fix the Ⓐ drain pan heater with the Ⓑ piercing screws.
- 5) Reattach the screw that was removed from the bottom frame.

Installation Procedure (3)

For type A models

Location and number of holes
Bottom frame: 2

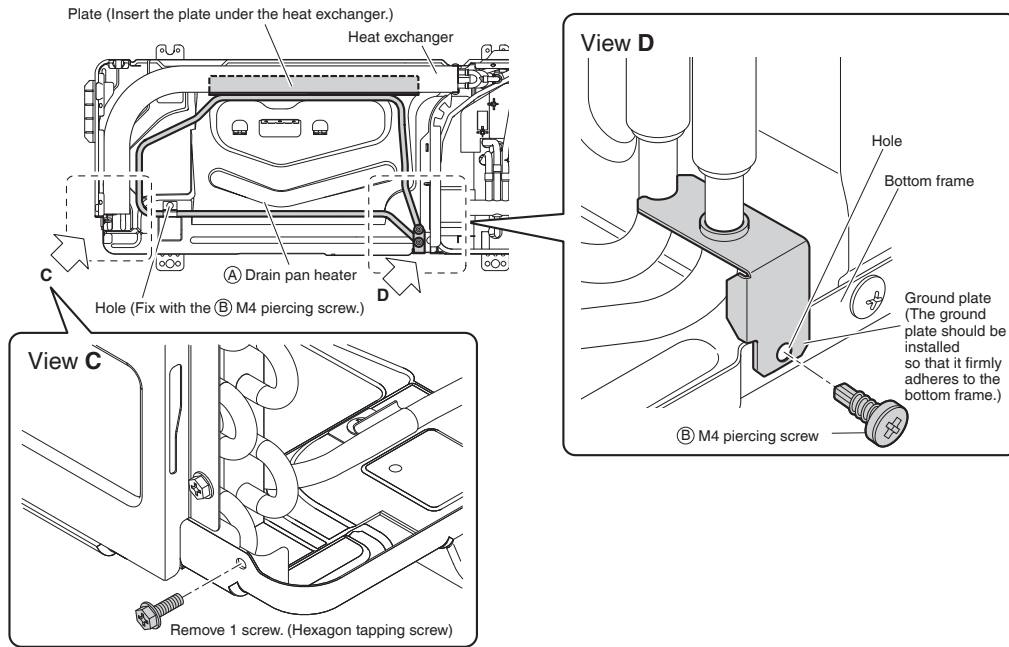

For type B and C models

Location and number of holes
Bottom frame: 1
Partition plate: 2

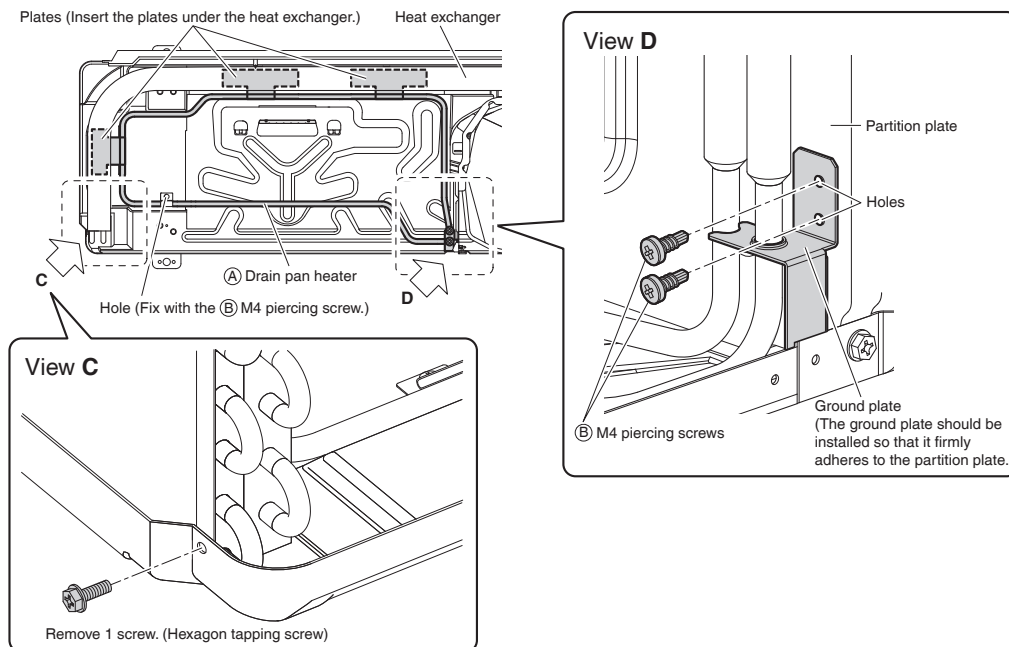

Installation Procedure (4)

4. Route the harnesses.

⚠ WARNING

- When drilling a hole, be careful not to damage the soundproofing material and other components on the back side.

For type A models

- 1) If there is no hole, drill a $\phi 1/8$ inch ($\phi 3.2\text{mm}$) hole in the partition plate. (1 location)
- 2) Fix in place the binding band attached to the (A) drain pan heater harness by screwing the (B) M4 piercing screw into the hole. (1 location)
- 3) Install the fan motor base.
 - Be careful not to confuse screw types. Refer to “Installation Procedure (2)”.
- 4) Place the (A) drain pan heater harness on top of the fan motor harness, and fix it in place with the (D) sealing material.

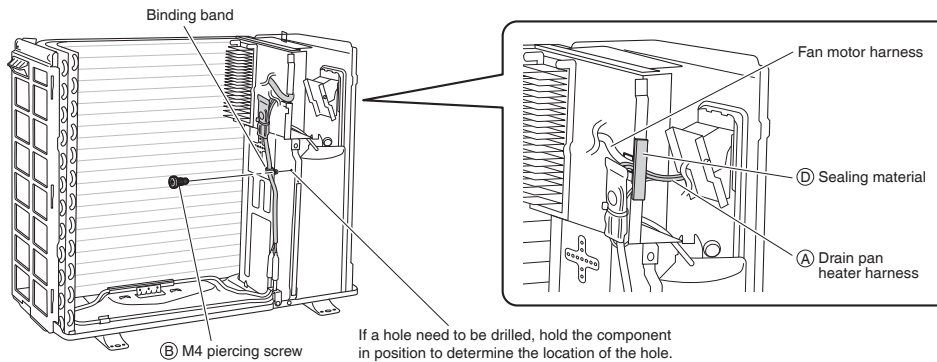

For type B and C models

- 1) If there are no holes, drill $\phi 1/8$ inch ($\phi 3.2\text{mm}$) holes in the partition plate. (3 locations)
- 2) Fix the (A) drain pan heater harness in place by screwing the (B) M4 piercing screws into the holes. (3 locations)
- 3) Install the fan motor base.
 - Be careful not to confuse screw types. Refer to “Installation Procedure (2)”.
- 4) Trim the electrical wiring box with nippers at the locations shown in the figures, then cover the trimmed edges with the (D) sealing material.
- 5) Insert the (A) drain pan heater harness into the space that was trimmed, and fix it in place using the (D) sealing material.

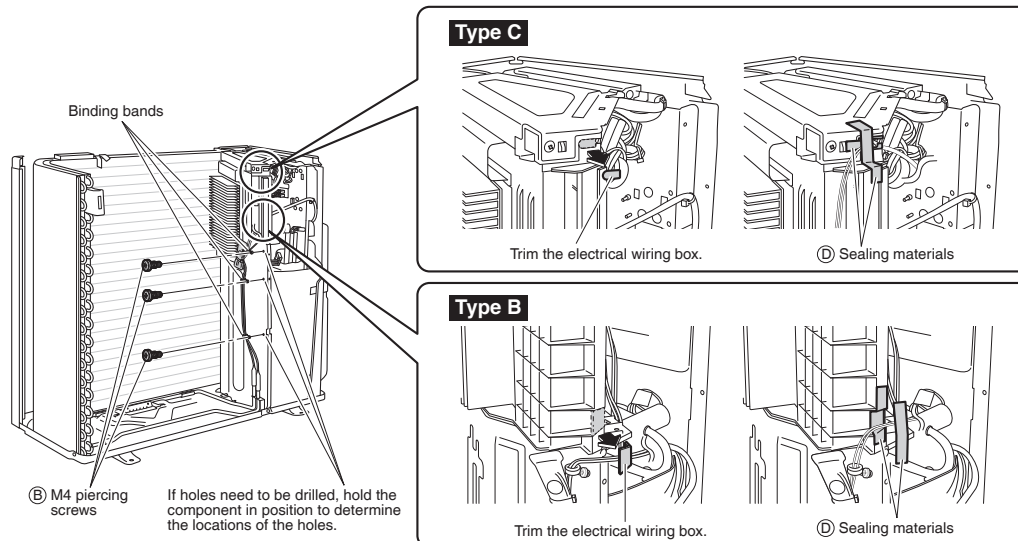

Installation Procedure (5)

5. Connect the faston terminals of the drain pan heater to the terminal block of the outdoor unit.

- 1) Connect the thermostat-side terminal (black harness) to the leftmost terminal and the heater-side terminal (white harness) to the second leftmost terminal.
 - For type C models, connect to the last terminal block of the terminal blocks in use.
- 2) Bundle the (A) drain pan heater harness so that there is no slack, and secure it with the (C) binding band. (1 location)
 - Cut the tip of the (C) binding band.

For type A models

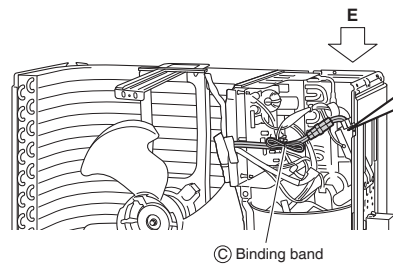

View E

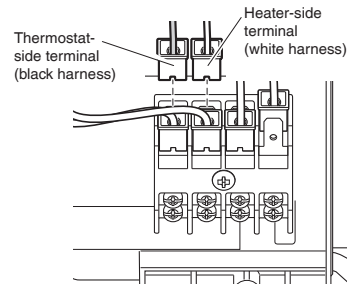

For type B models

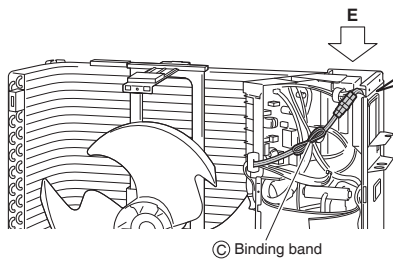

View E

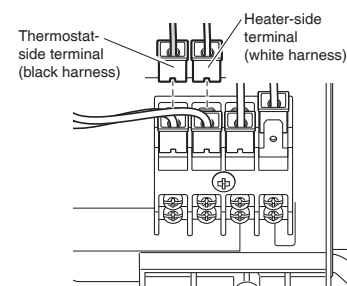

For type C models

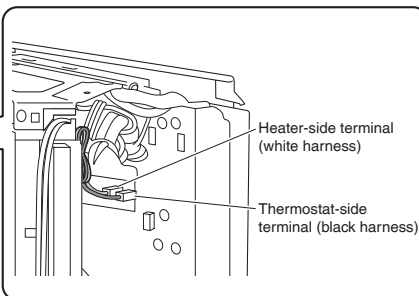
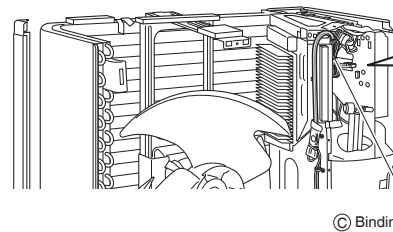





6. Install each component to the original position.

- Be careful not to confuse screw types. Refer to "Installation Procedure (1)".
 - 1) Install the front plate.
 - 2) Install the anti-drip cover.
 - (For type B and C models only)
 - 3) Install the top plate.

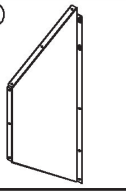
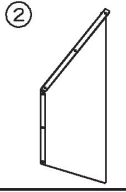
13.17 <KPS063A41> Snow Hood (Intake Side Plate)

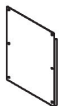
Parts Before assembling the product, verify that all of the following parts have been included:

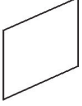
Name	Side plate (right)	Side plate (left)	Top plate	Front plate	Screws	Installation Manual
Illustration	① 	② 	③ 	④ 	⑤  (quantity to use 14)	⑥ 
Quantity	1	1	1	1	16	1 (this document)

⚠ Caution Read these safety considerations for installation carefully before installing the product.

● Be sure to observe the following installation precautions to ensure that the product can be used safely:

1. Install the product so that it is situated high enough to allow access to the outdoor unit for maintenance.
2. Installing the product in a location in which it may be exposed to strong winds, secure the outdoor unit with wire or other means.
3. Choose a location where the operating sound will not cause a nuisance to the neighbors of the user.
4. Tighten screws securely. Failure to do so may result in vibration.

⚠ Caution
Indicates a potentially hazardous situation which, if not avoided, may result in minor or moderate injury. It may also be used to alert against unsafe practises.

1 Installing the snow hood (intake side plate)

1 Remove the protective wire mesh

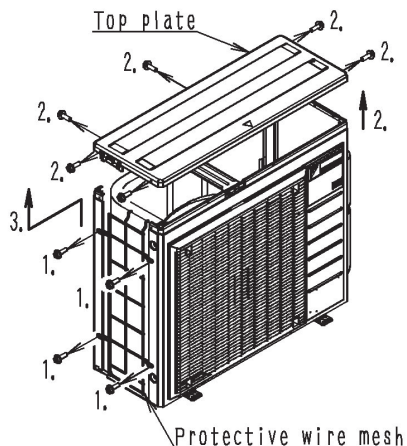

1. Remove the 2 screws that hold the protective wire mesh.
2. Remove the 6 screws that hold the top plate and remove the top plate.
3. Remove the protective wire mesh, being careful of the part that is attached to the heat exchanger.
4. Attach the top plate removed in step 2 using the 6 screws removed in step 2.

2 Attach the side plate (right) ①

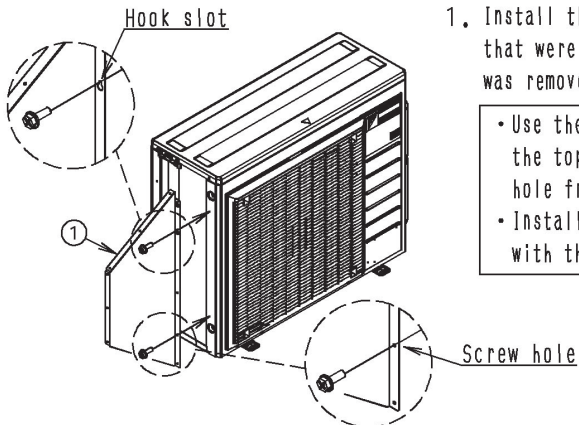

1. Install the side plate (right) ① with the 2 screws that were used in the protective wire mesh that was removed in step 1.

- Use the second hook slot from the top and the 2 screw hole from the bottom.
- Installation is easiest if you start with the hook slot.

③ Attach the side plate (left) ②.

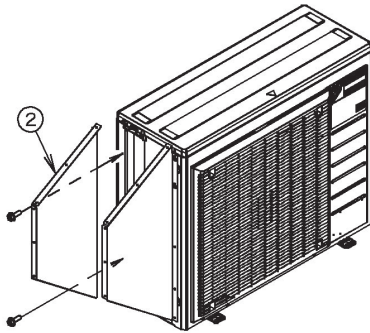

1. Install the side plate (left) ② with the 2 screws that were used in the protective wire mesh that was removed in step ①.

- Use the second hook slot from the top and the 2 screw hole from the bottom.
- Installation is easiest if you start with the hook slot.

④ Attach the front plate ④.

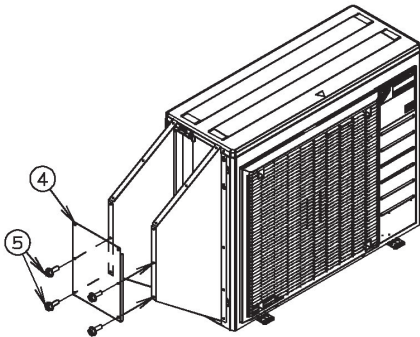

1. Temporarily secure the front plate ④ in place with the 4 screws ⑤.

⑤ Attach the top plate ③.

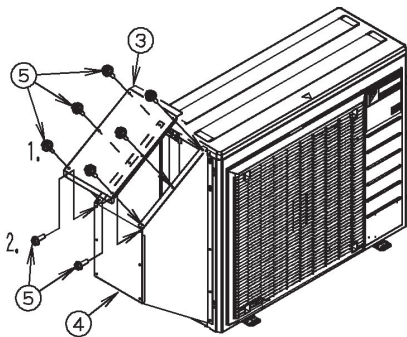

1. Attach the top plate ③ with the 6 screws ⑤.
2. Temporarily secure the top plate ③ and the front plate ④ to the side plate (right) ① and the side plate (left) ② with the 2 screws ⑤.
3. Tighten the 12 screws ⑤ that you used to temporarily secure parts in steps ④ and ⑤.

② Appearance of the snow hood (intake side plate) after installation

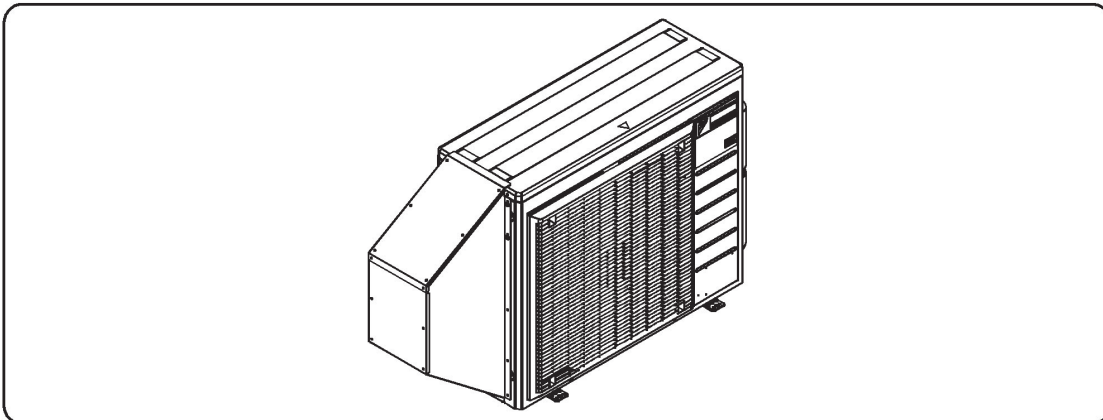

13.18 <KPS063A44> Snow Hood (Intake Rear Plate)

Parts Before assembling the product, verify that all of the following parts have been included:

Name	Side plate (Right)	Side plate (Left)	Top plate	Front plate	Screws	Piercing screw	Installation Manual
Illustration							
Quantity	1	1	1	1	14	3	1 (this document)

⚠ Caution Read these safety considerations for installation carefully before installing the product.

● Be sure to observe the following installation precautions to ensure that the product can be used safely:

1. Install the product so that it is situated high enough to allow access to the outdoor unit for maintenance.
2. Installing the product in a location in which it may be exposed to strong winds, secure the outdoor unit with wire or other means.
3. Choose a location where the operating sound will not cause a nuisance to the neighbors of the user.
4. Tighten screws securely. Failure to do so may result in vibration.

⚠ Caution

Indicates a potentially hazardous situation which, if not avoided, may result in minor or moderate injury. It may also be used to alert against unsafe practises.

1 Installing the snow hood (intake rear plate)

1 Attach the side plate (right) ①.

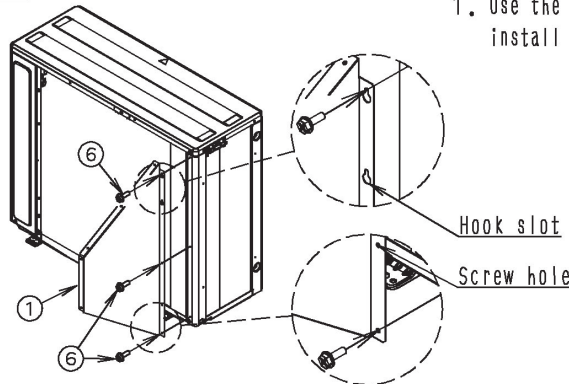

1. Use the 3 piercing screws ⑥ included in the kit to install the side plate (right) ①.

- For the hook slot, use the first hook slot from the top.
- For the screw hole, use the first screw hole from the bottom.
- Installation is easiest if you start with the hook slot.
- Align the screw installation position with the dowel hole.

2 Attach the side plate (left) ②

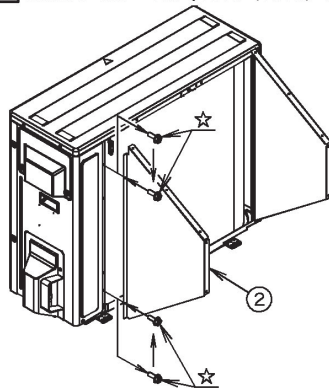

1. Remove the 2 screws (☆) that hold the heat exchanger.
2. Install the side plate (left) ② using the 2 screws removed in step 1.

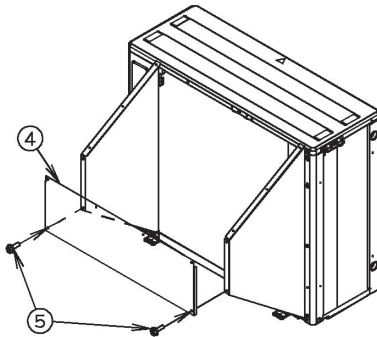
3 Attach the front plate ④

1. Temporarily secure the front plate ④ in place with the 2 screws ⑤ included in the kit.

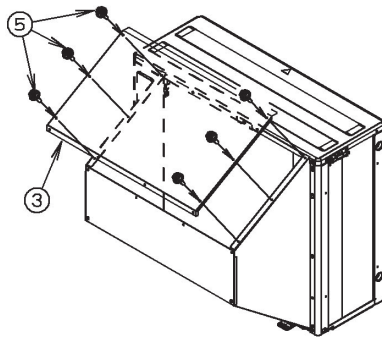
4 Attach the top plate ③

1. Temporarily secure the top plate ③ in place with the 6 screws ⑤ included in the kit.

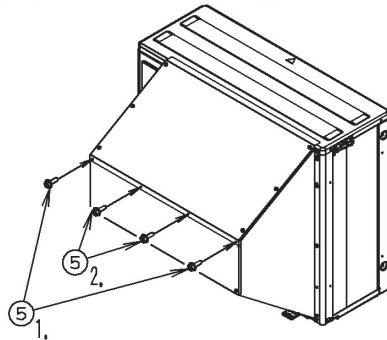
5 Attach the top plate ③

1. Temporarily secure the top plate ③ and front plate ④ to the side plate (right) ① and side plate (left) ② with the 2 screws ⑤ included in the kit.
2. Temporarily secure the top plate ③ to the front plate ④ with the 2 screws ⑤ included in the kit.
3. Tighten the 12 screws that you used to temporarily secure parts in steps 3), 4), and 5).

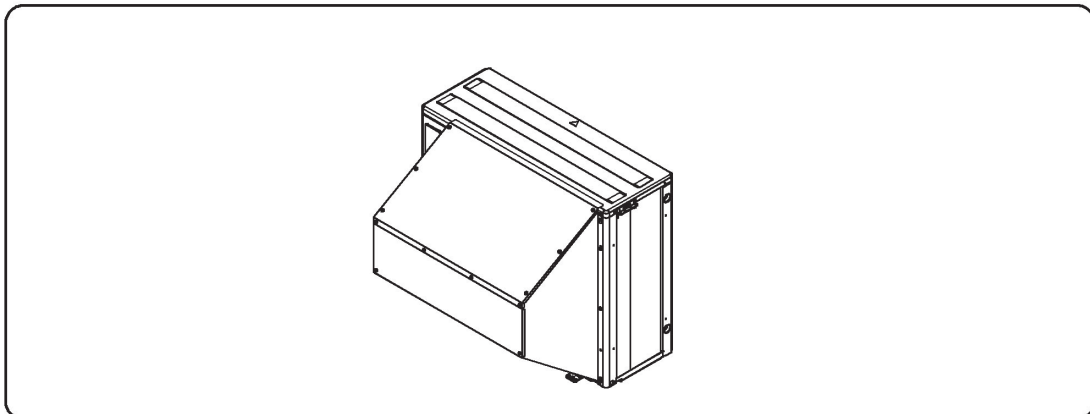
2 Appearance of the snow hood (intake rear plate) after installation

13.19 <KPS063A47> Snow Hood (Outlet)

Parts Before assembling the product, verify that all of the following parts have been included:

Name	Side plate (Right)	Side plate (Left)	Top plate	Installation plate	Screws	Piercing screw	Installation Manual
Illustration							
Quantity	1	1	1	1	8	3	1 (this document)

⚠ Caution Read these safety considerations for installation carefully before installing the product.

- Be sure to observe the following installation precautions to ensure that the product can be used safely:
 1. Install the product so that it is situated high enough to allow access to the outdoor unit for maintenance.
 2. Installing the product in a location in which it may be exposed to strong winds, secure the outdoor unit with wire or other means.
 3. Choose a location where the operating sound will not cause a nuisance to the neighbors of the user.
 4. Tighten screws securely. Failure to do so may result in vibration.

⚠ Caution
Indicates a potentially hazardous situation which, if not avoided, may result in minor or moderate injury. It may also be used to alert against unsafe practices.

1 Installing the snow hood (outlet)

1 Remove the discharge grille.

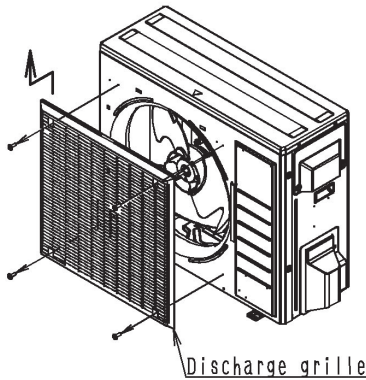

1. Remove the 4 screws that hold the discharge grille. (The discharge grille is held with the 4 screws and 2 hooks.)

2 Attach the side plate (left) ② and installation plate ④.

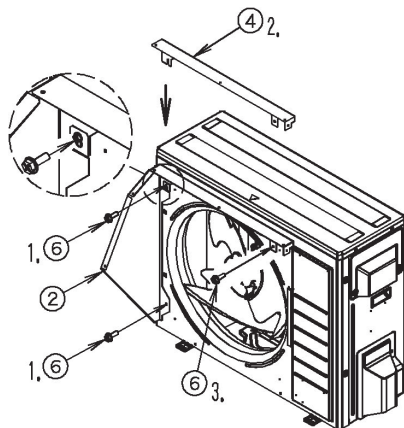

1. Temporarily secure the side plate (left) ② in place with the 2 piercing screw ⑥ included in the kit.

- Installation is easiest if you start with the hook slot.
 - Align the screw installation position with the dowel hole.
2. Jointly tighten the installation plate ④ with the 1 piercing screw ⑥ temporarily secured in step 1.
3. Install the right side of the installation plate ④ with the 1 piercing screw ⑥.

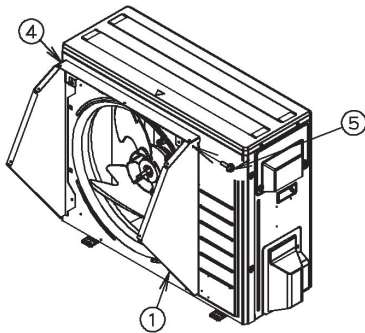
3 Attach the installation plate ④.

1. Install the side plate (right) ① and installation plate ④ with the 1 screws ⑤ included in the kit.

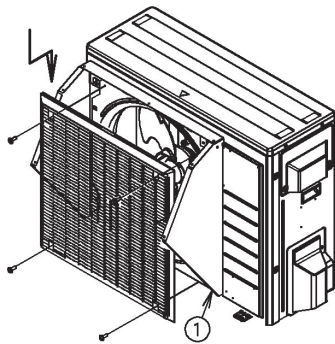
4 Attach the discharge grille.

1. When installing the discharge grille removed in [1], jointly tighten the side plate (right) ① with the 2 screws securing the discharge grille. (Secure the discharge grille with the 4 screws and 2 hooks.)

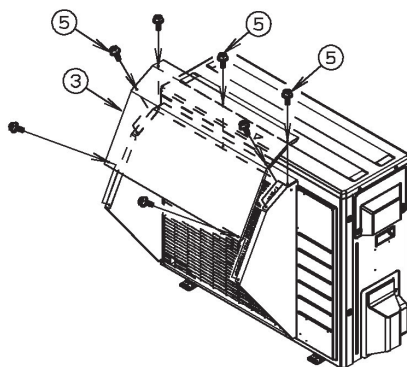
5 Attach the top plate ③.

1. Install the top plate ③ with the 7 screws ⑤ included in the kit.

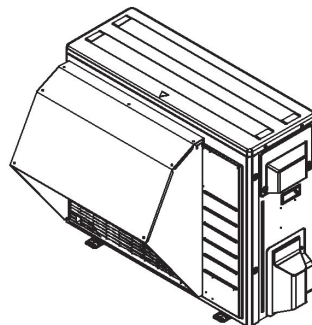
2 Appearance of the snow hood (outlet) after installation



Warning



- Ask a qualified installer or contractor to install this product. Do not try to install the product yourself. Improper installation can result in water or refrigerant leakage, electrical shock, fire or explosion.
- Use only those parts and accessories supplied or specified by Daikin. Ask a qualified installer or contractor to install those parts and accessories. Use of unauthorised parts and accessories or improper installation of parts and accessories can result in water or refrigerant leakage, electrical shock, fire or explosion.
- Read the user's manual carefully before using this product. The user's manual provides important safety instructions and warnings. Be sure to follow these instructions and warnings.

If you have any inquiries, please contact your local importer, distributor and/or retailer.

Cautions on product corrosion

1. Air conditioners should not be installed in areas where corrosive gases, such as acid gas or alkaline gas, are produced.
2. If the outdoor unit is to be installed close to the sea shore, direct exposure to the sea breeze should be avoided. If you need to install the outdoor unit close to the sea shore, contact your local distributor.