

Install the flushmount

Before starting the installation process, turn off the power supply to all units. Do not turn power back on until the flushmount installation process is completed. Power is needed in order to commission the system.

Use caution when cutting with a drywall saw. Cutting or damaging wires can result in a short circuit.

Get help at www.daikinone.com/smart_thermostats/oneplus/pros

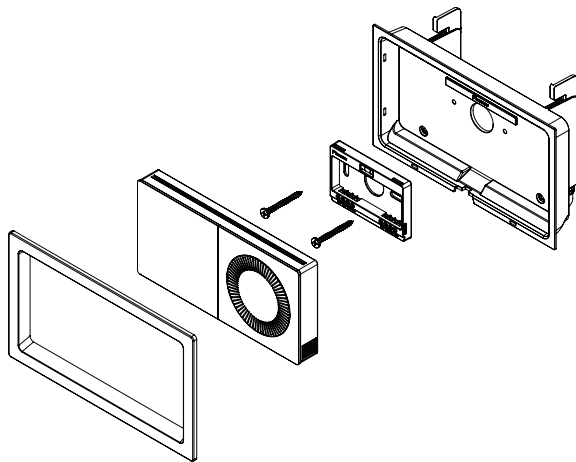

Face plate Thermostat Screws Terminal plate Flushmount

Select Location

Place the template in the desired location on the wall you want to install the flushmount. Use a stud and wire finder to verify any obstructions in the desired location. Allow a minimum 1 inch clearance between the selected location and stud for tightening and leveling purposes. Confirm that the wires are a sufficient length to meet with the center of the flushmount and can connect to the terminal plate.

Cut Drywall

Align the terminal plate with the template cutout hole and use the bubble level to ensure a professional installation. With a pencil, trace around the outside edges of the template. Using a drywall saw, start from the middle of the top edge and cut towards the two top corners. Starting the cutting process in this order will allow for the template to be repositioned on wall in event that a stud was unaccounted for. Continue cutting along the penciled outline until the hole is complete.

Trace around template edges.

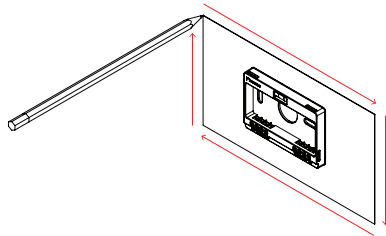

Cut with a drywall saw to make the installation hole.

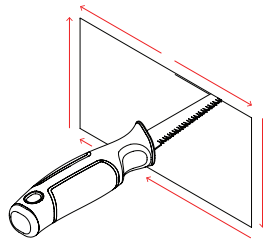

Install Flushmount

Once done with cutting, place the flushmount directly into the resultant hole. Feed the wiring through the back of the flushmount to connect to the terminal plate. Tighten the four screws included on the flushmount to ensure the mounting tabs align properly on the wall. Continue tightening the screws until you feel resistance to lock the piece in place on the wall.

Install Thermostat

Refer to the documentation included in the Daikin One+™ Smart Thermostat packaging to install the thermostat.

Place flushmount in installation hole.

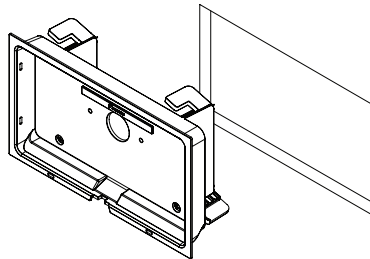

Tighten screws to align mounting tabs.

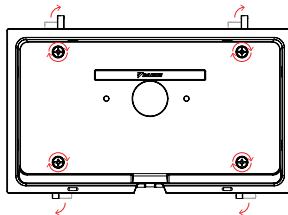

Attach Face Plate

After completing the thermostat installation process, place the face plate on the thermostat and press down firmly until it snaps into place. Then, turn on power to the indoor unit.

Commission and Calibrate Thermostat

Refer to the documentation included in the Daikin One+™ Smart Thermostat packaging to commission the system. After the thermostat is powered on for at least 30 minutes, calibrate the system for accurate temperature sensor readings.

Mounting tabs locking piece in place on the wall.

Tabs extended with no resistance

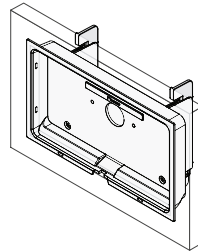

Tabs tightened locking piece in place

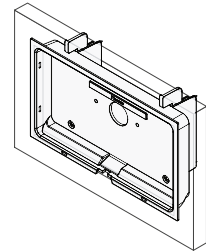

Install thermostat and attach face plate.

