

Daikin One+ for P1-P2 Installation & Commissioning

Technical Training Module XX-XX

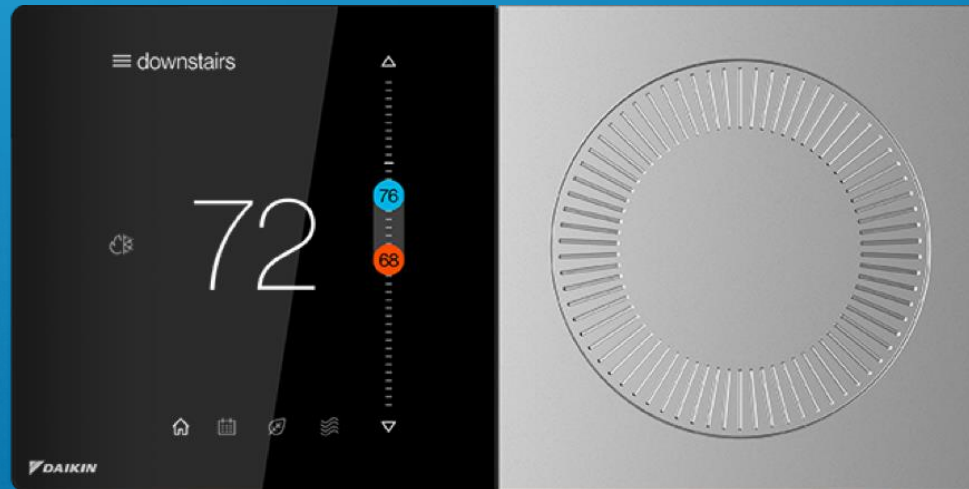

Disclaimer

This material provides technical information that is to only be used by appropriately trained and certified HVAC-R installers and technicians who have agreed to the terms and conditions available here at <https://www.daikincity.com/DaikinCityB2BTermsOfUse.html>. If you have not agreed to these terms and conditions, you may not use or view this material, and you assume responsibility for any injury or property, system or equipment damage which may result. If you have agreed to these terms, you also agree, by viewing or using this material, that this material, by its nature, cannot include a discussion of everything necessary to effect a proper installation or repair of HVAC-R equipment, nor can it address every possible scenario or environment a technician or installer may encounter. Accordingly, this material should not be considered as recommendations for best practices and will not be considered installation or repair instructions to the extent of any conflict with Daikin- or Goodman-issued manuals and specifications, or industry standards and regulations. Each installer or technician remains fully responsible for ensuring proper installation or repair of the HVAC-R equipment being worked on, and you remain fully responsible for any injury or property, system or equipment damage which may result from your installation. ©2020 Daikin, all rights reserved; recording, copying, or distribution of this material is prohibited without express written permission from Daikin.

Agenda

Daikin One+

System Configurations

Installing Daikin One+

Commissioning Daikin One+

Dealer Navigation

Homeowner Navigation

Daikin One+

- Premium control that provides optimal comfort.
- Easy to use, energy efficient, reliable, and ensures that the system is set up properly.
- Designed to regulate and communicate with HVAC equipment.
- The thermostat has a physical dial on the right used for manual setpoints adjustments.
- Pressing the center of the dial at any time during normal mode acts as a home button, displaying the primary screen.
- The high-resolution touch screen on the left supports tactile-based interactions.
- Navigating to each screen is done by tapping an icon.
- The user will be able to control the indoor unit remotely through The Daikin ONE Home App.

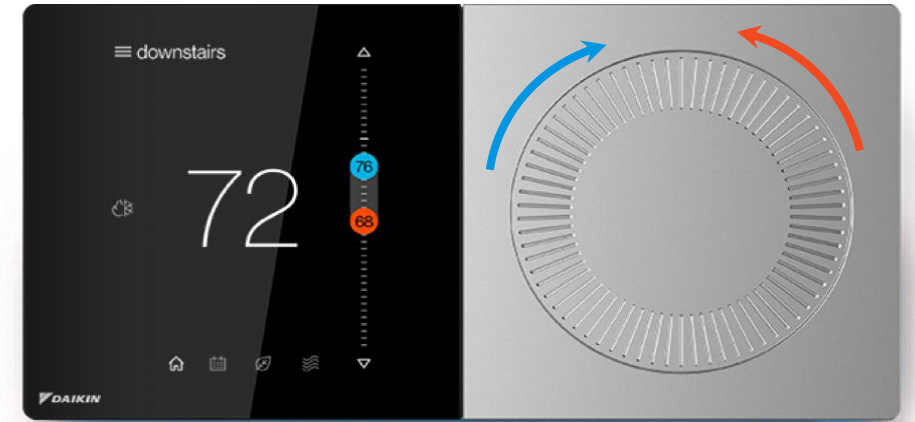

Agenda

Daikin One+

System Configurations

Installing Daikin One+

Commissioning Daikin One+

Dealer Navigation

Homeowner Navigation

Daikin One+ for P1P2 Indoor Units



- Offers communication to VRV, SkyAir and Single- and Multi-zone indoor units through the P1P2 communication bus.
 - Backward compatible with older P1P2 indoor units



Indoor Unit	Model Number
VRV and VRV Life (P1P2)	CXTQ, FXAQ, FXDQ, FXEQ, FXFQ, FXHQ, FXLQ, FXMQ, FXNQ, FXSQ, FXTQ, FXUQ, FXZQ
SkyAir (P1P2)	FAQ, FBQ, FTQ, FCQ, FHQ
Single-Zone and Multi-Zone (P1P2)	FDMQ, FFQ

VRV System

Communication

- VRV outdoor units maintain communication with indoor units via F1-F2 loop
- The outdoor unit PCB assigns each indoor unit an individual address automatically
 - Logically, this address is separate from the group address
- The outdoor unit PCB monitors indoor units' PCB status
 - Calls for cooling and heating (THERMO ON), etc.
- The outdoor unit PCB supervises indoor units for specific operations and status, etc.
 - System level malfunctions
 - Oil recovery operation mode
 - Defrost operation mode



VRV System

Heat Pump

- Only one indoor unit in the system can be the mode master
- The mode master determines the outdoor unit operation mode.
- The operational modes are changed only by the mode master (Auto, cool, heat and Off)
- Other indoor units follow the master's mode

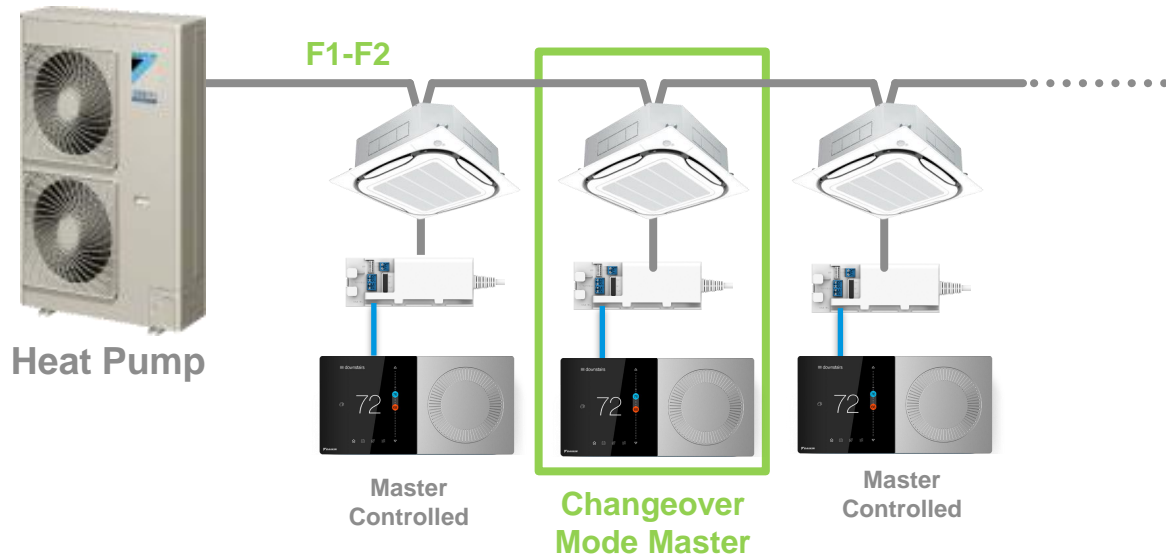

Heat Recovery

- Only one indoor unit connected to a BS-Box can be the mode master
- The operational modes are changed only by the mode master (Auto, cool, heat and Off)
- The mode master determines the BS-Box operation mode
- Other indoor units connected to the same BS-box will follow the master's mode

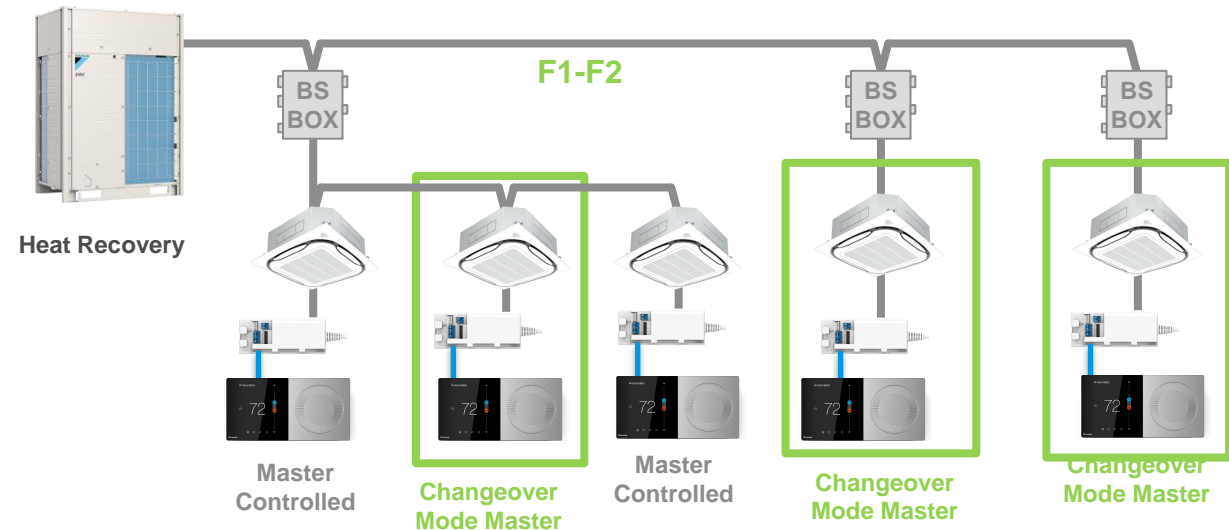

Mode Master/Master Controlled

- The mode master indoor unit is selectable during the commissioning process.
- Master controlled will follow the mode master:

Mode master IDU	Available modes on the ONE+ for the master controlled IDU
Mode Master is Auto-cool	Cool, Off, Emergency Heat*
Mode Master is Auto-heat	Heat, Off, Emergency Heat*
Mode Master is Cool	Cool, Off, Emergency Heat*
Mode Master is Heat	Heat, Off, Emergency Heat*

*The Emergency heat mode will not be displayed on the ONE+ operation mode until the Aux heat is set.

■ Notes:

- The master controlled indoor unit will not be able to change the system operation mode, the ONE+ will display what is the allowed modes.
- If the mode master is on cooling mode and the “master controlled” is connected to aux heater, the master controlled can run emergency heat mode while the master in cool mode.

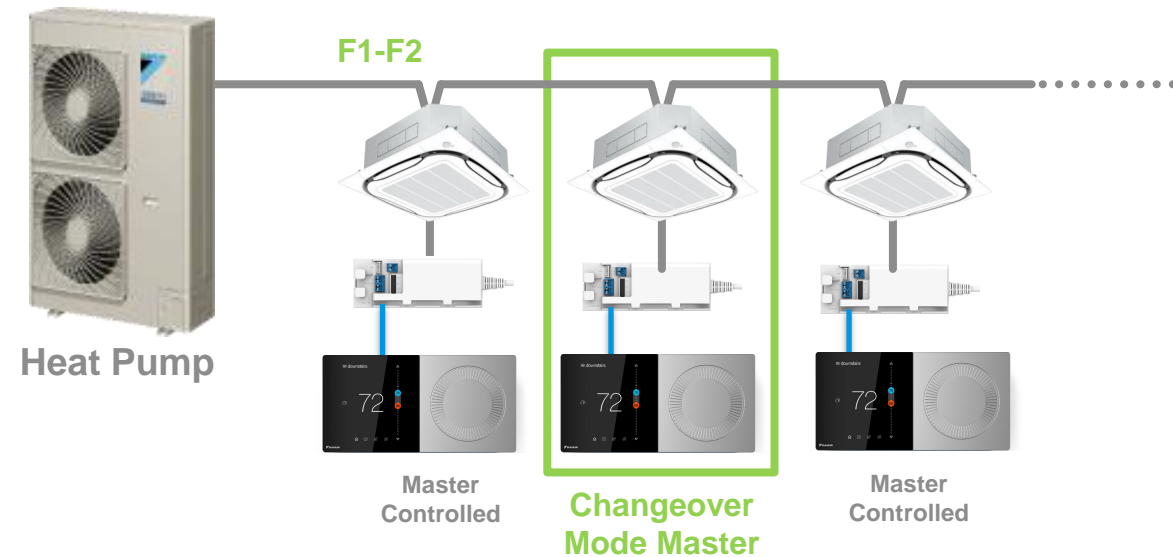

Mode Master/Master Controlled - Display

- The mode of the master controlled indoor unit will follow the mode of the changeover Master indoor unit.

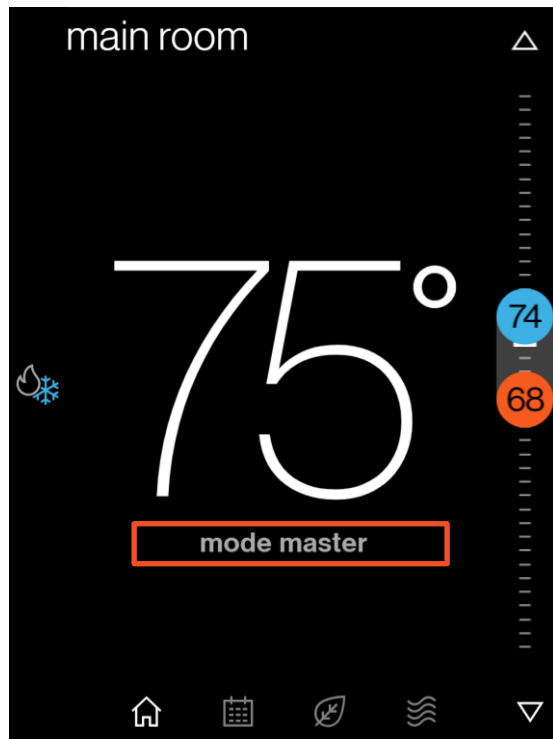

ONE+ is connected to a mode master IDU

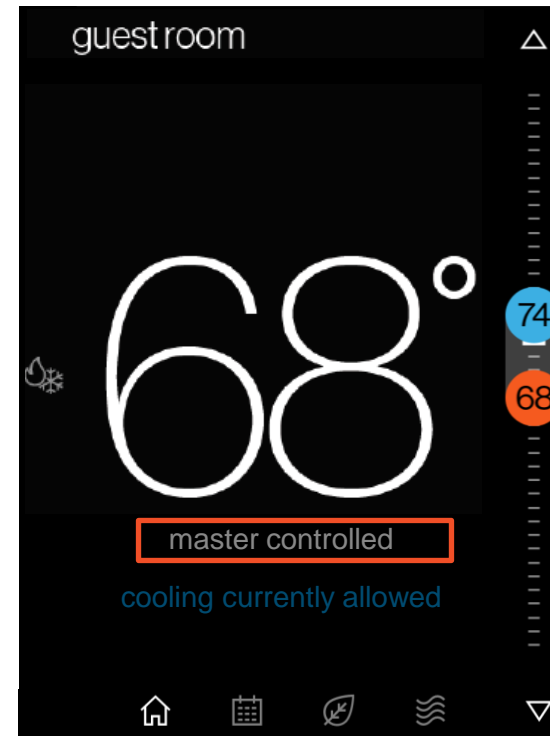
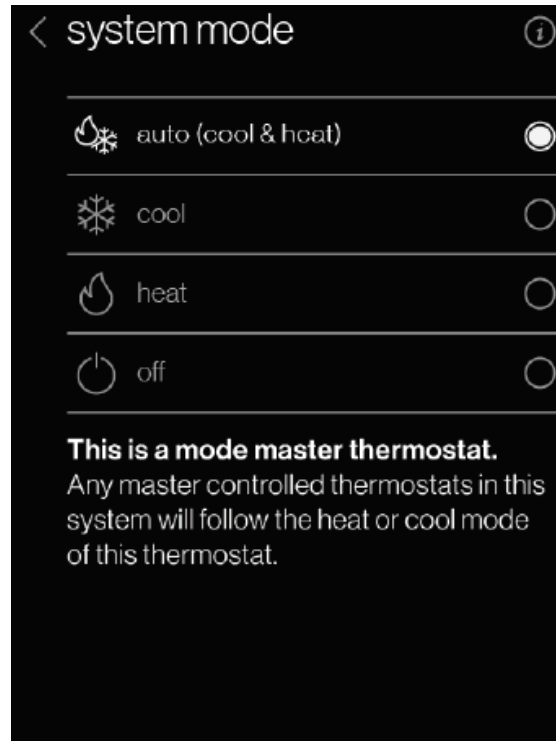

ONE + is connected to a master controlled IDU

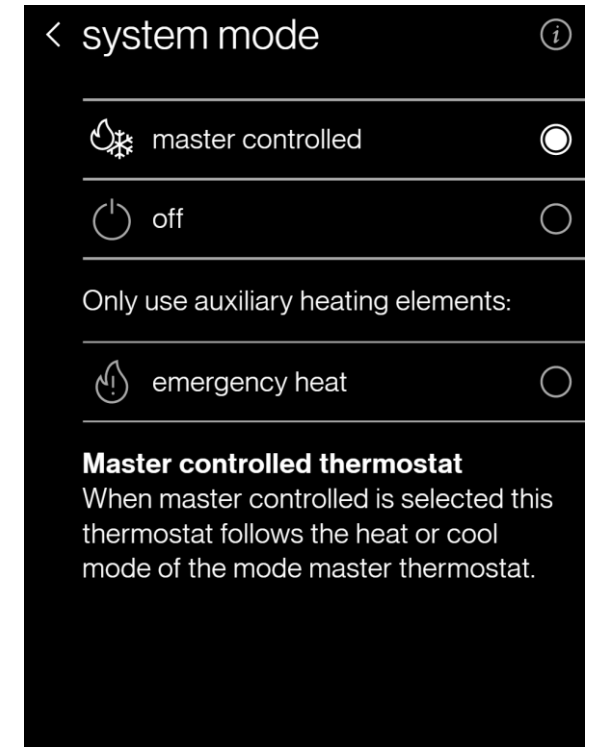

Daikin One+ for P1P2 Indoor Units



- The ONE+ can connect to 16 indoor units (P1P2 daisy Chain)

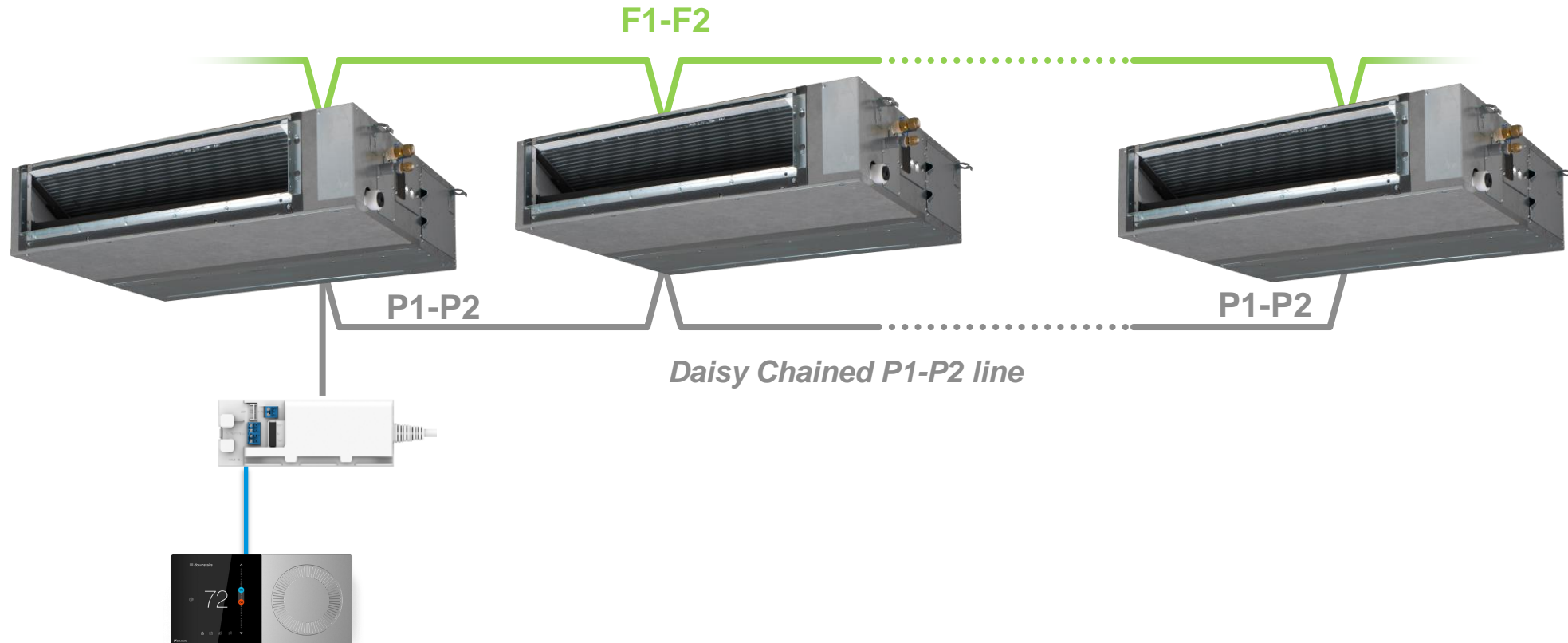



Compatibility - Local controller (main/sub)

- The ONE+ doesn't support main and sub remote controller configuration.
- The Daikin One+ cannot be used together with other wireless or wired remote controllers.
 - For retrofit project, please remove any other remote controller(s) before installation.



Compatibility – Central controller

- The Central controllers are compatible for the purpose of **monitoring only**.
- If a central controller (**iTM, BACnet, Modbus, LON interfaces or Service Checker**) is connected to the VRV system, commands sent by the central controller to the IDU will be overwritten by the One+

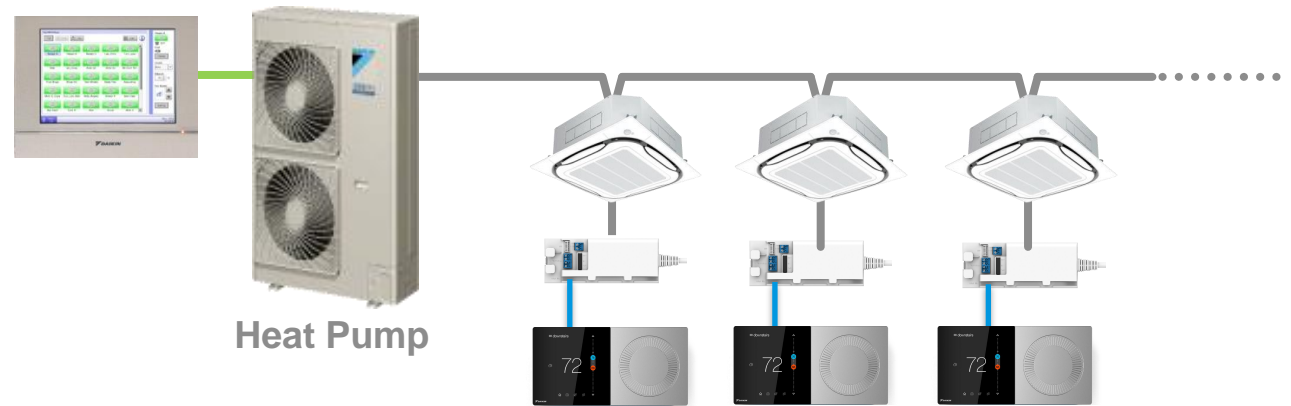

Agenda

Daikin One+

System Configurations

Installing Daikin One+

Commissioning Daikin One+

Dealer Navigation

Homeowner Navigation

Daikin One+

Packaging

- Welcome documentation.
 - Includes quick reference cards.
- Daikin One+ smart thermostat.
- Translation adapter with cover, mounting plate and power cable.
- Double-sided adhesive tape.
- Mounting screws.
 - One set for thermostat.
 - One set for translation adapter.
- Thermostat terminal plate.
- S21 cable – Don't use for P1P2 IDU
- Optional trim plate.

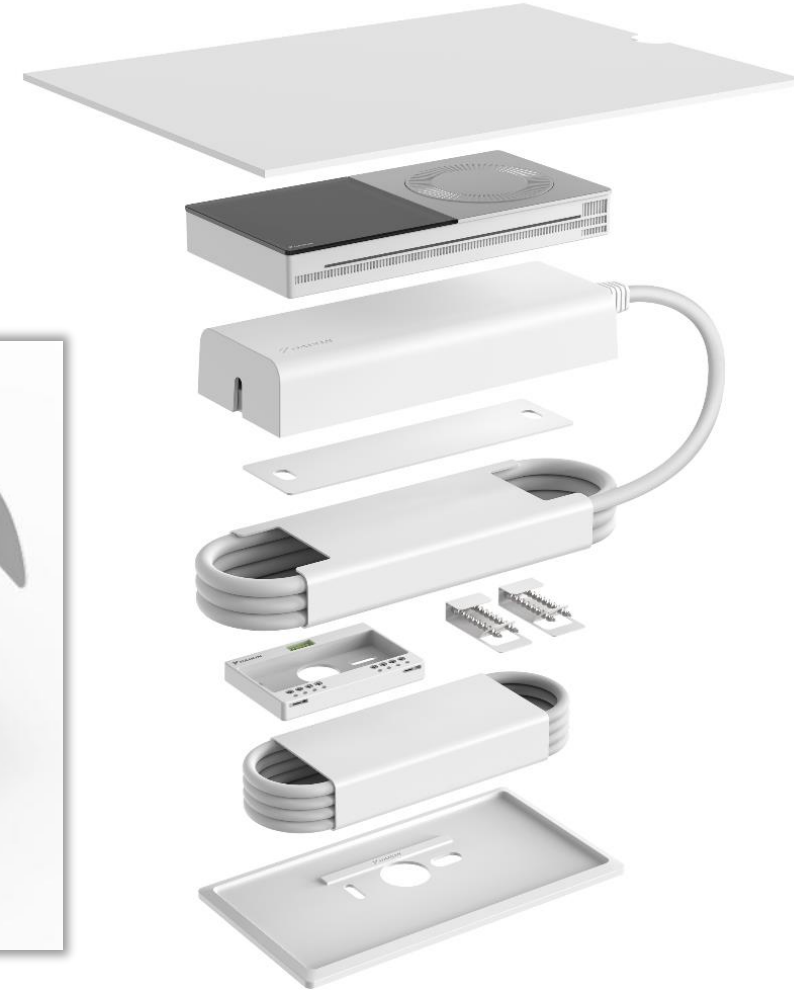

Daikin One+

Quick Reference Card

- Quick reference cards are packaged with the thermostat to help answer questions during the installation and commissioning.



- Scanning** the bar code on the **bottom left** corner will link you to a website related to the title of the card. https://daikinone.com/smart_thermostats/oneplus/pros/

Wiring thermostat to a translation adaptor – P1P2

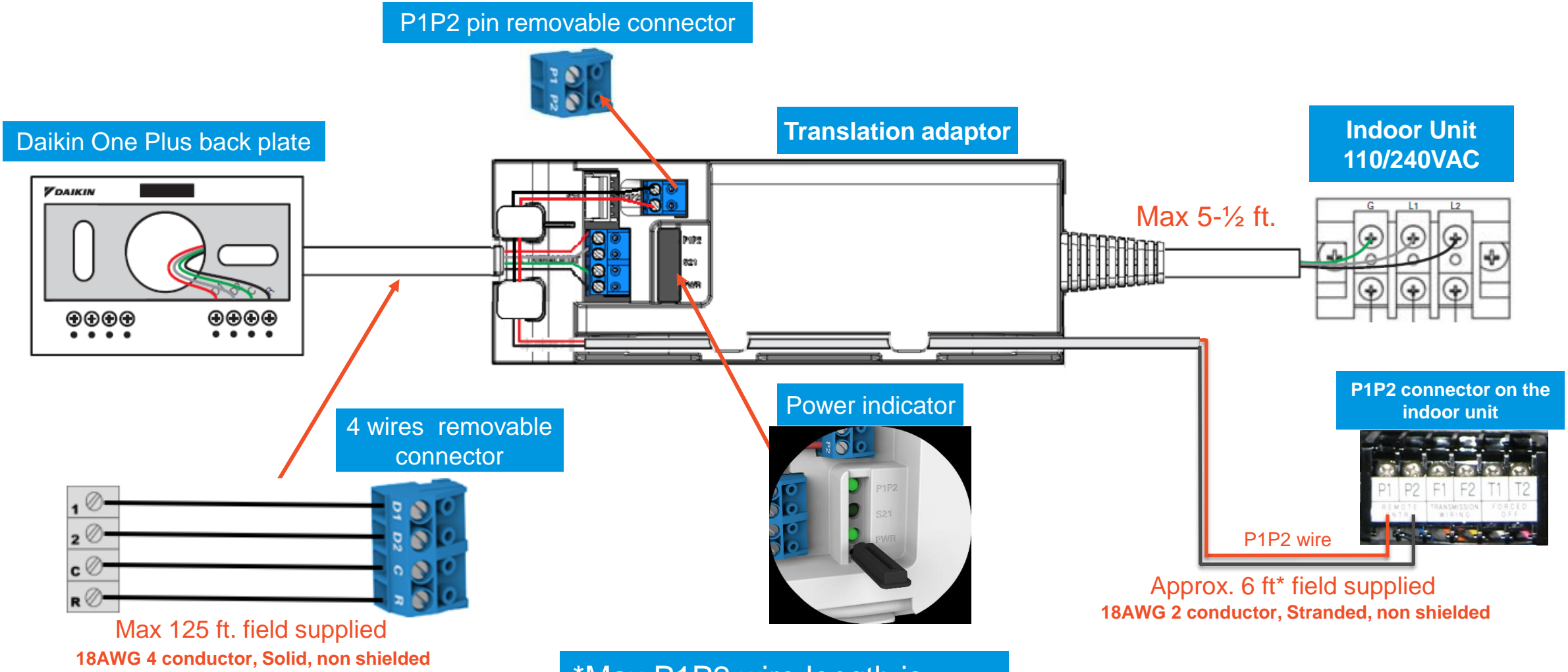

Installing Daikin One+

91

92

- Check for proper voltage before and after wiring is installed.
 - Typical 0.6VDC between Data 1 and 2.
 - 24VDC between R and C.
 - Refer to system I/O manual for proper voltage.
- Note:
- If wired incorrectly, you will receive an error.
 - If power wires are reversed the PWR LED will flash green.



- ① Data Line 1
- ② Data Line 2
- C 24 VDC common
- R 24 VDC power

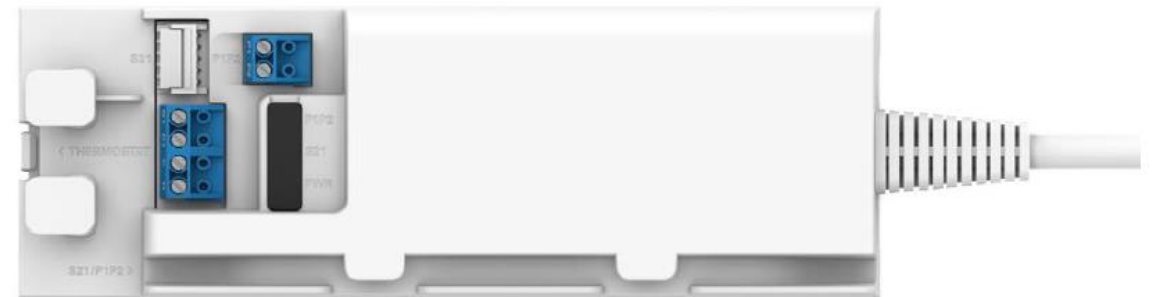

Aux1 to Aux1C and Aux2 to Aux2C
Connections are Dry contacts
(contacts are rated for Max 24VAC)

Aux wiring

- The thermostats Aux outputs are dry contacts that close the connection to turn on the Aux equipment.
- A 24V AC control signal must be routed through one of the aux contacts of the thermostat.

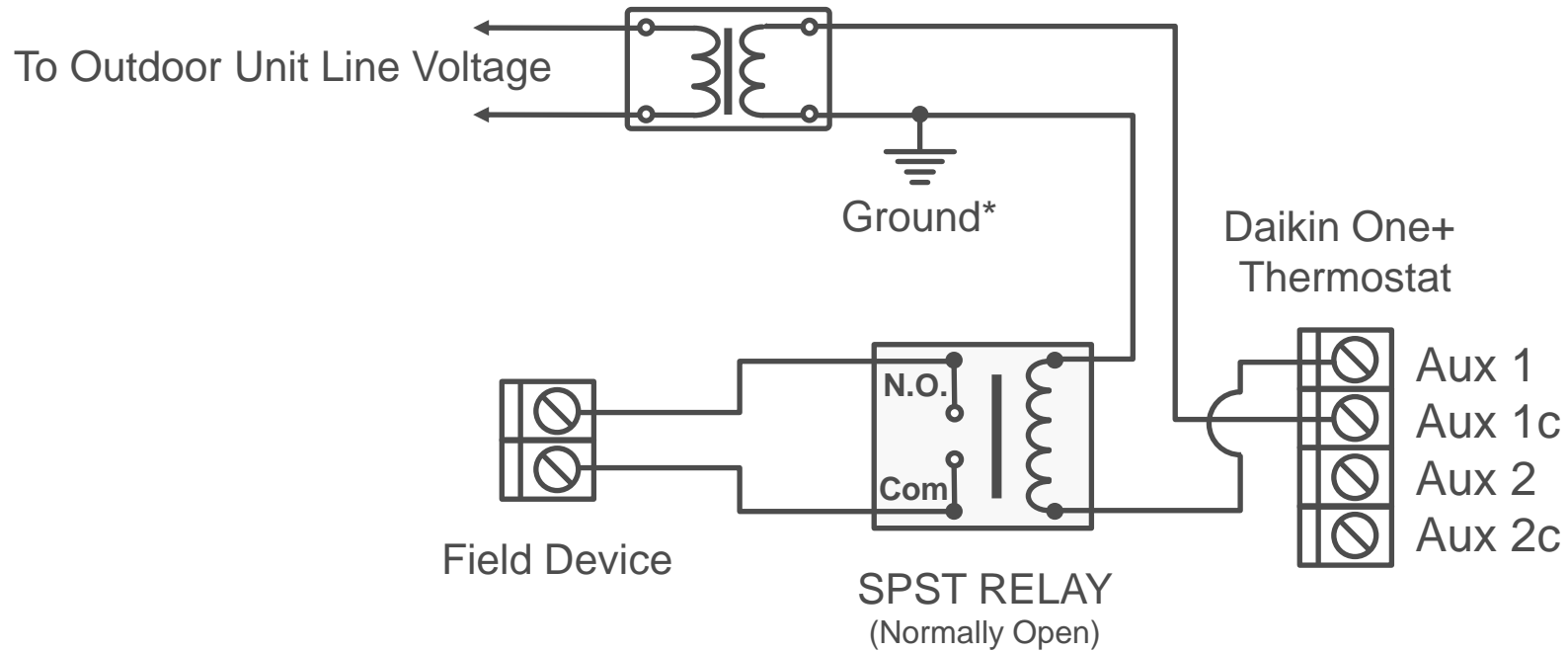

*The terminals are selected in the Daikin *One+* installer wizard.

Note: It is recommended to use a minimum of 18-gauge wire. Maximum operating length of wire is 125 ft.

Installing Daikin One+

93

94

- Mount the thermostat to be
 - Leveled.
 - Approximately 5' from the floor.
 - On an interior wall using the included screws.

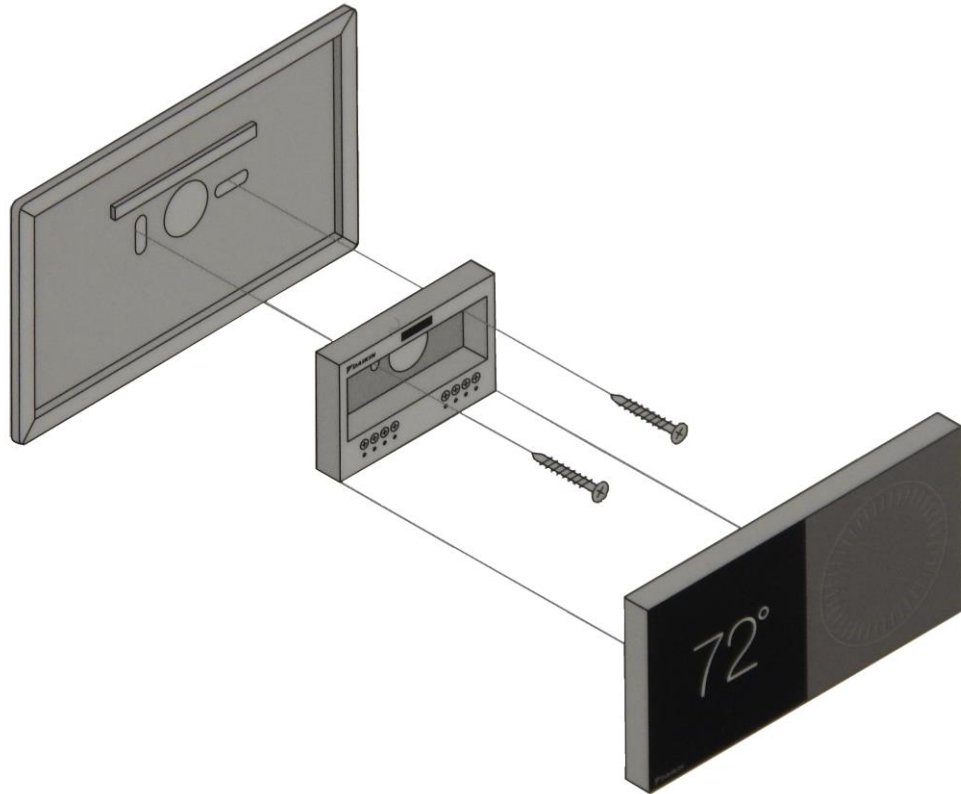

FLOOR

DO NOT Install The Thermostat Where It Can Be Affected By:

- Drafts or dead spots behind doors and in corners.
- Hot or cold air from ducts or ceiling fans.
- Radiant heat from the sun or appliances.
- Concealed pipes and chimneys.
- Unheated (uncooled) areas such as an outside wall.



Installing Translation Adaptor



Mounting the translation adaptor.

- Mount using screws or adhesive tape.
 - Never use screws to mount to an indoor unit.
 - If using adhesive tape, you can mount to the surface of the indoor unit.
 - Clean the surface prior to mounting.
 - Apply pressure for a minimum of 20 seconds to the adaptor for adhesion to take place.

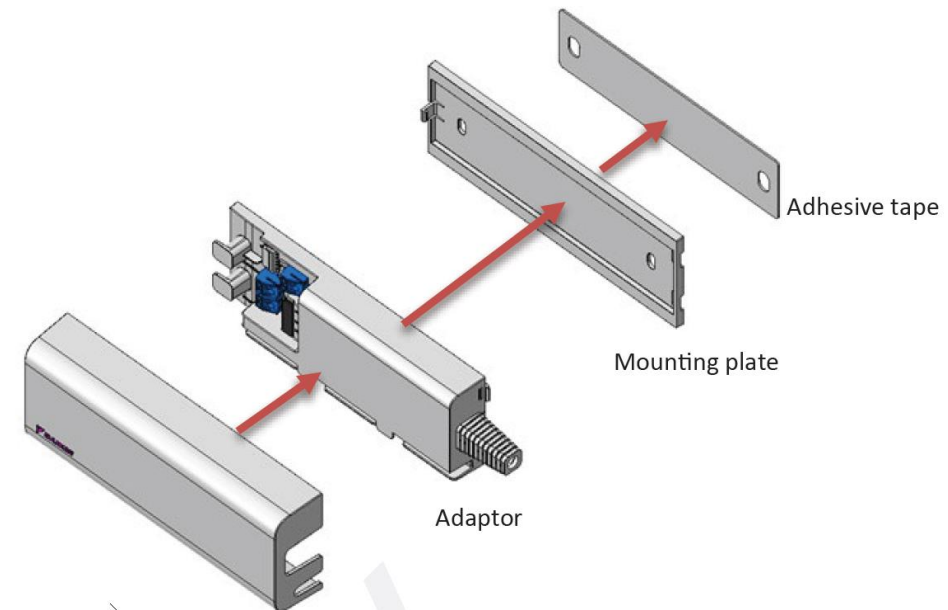
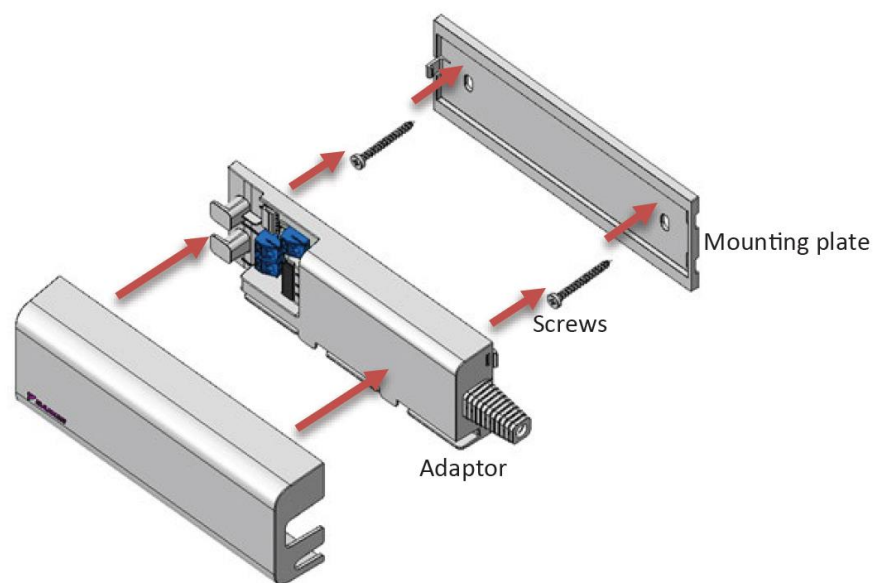

Installing Translation Adaptor

Wall mounted indoor unit

- Mount Translation adaptor inside piping chase to conceal it, or on the outside of the indoor unit.
- For the wall-mounted unit, the front cover is optional if the adaptor is mounted inside the piping chase.

Translation adaptor

Dimensions: 2.7" x 7.3" x 1.3"

Operating Temperature: -40°F to 140°F

Operating Humidity: 20 to 95%RH (non-condensing)

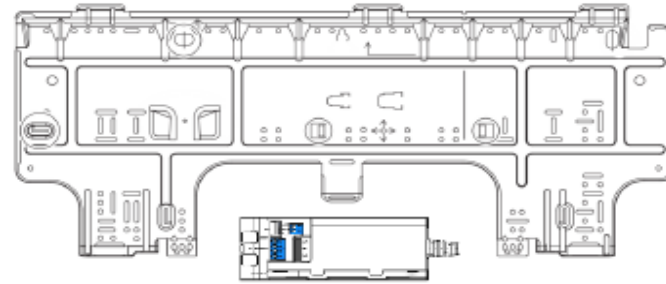

Other Indoor units

- Translation adaptor can be mounted on the side and top of the indoor unit, or above the ceiling using supplied double-sided adhesive tape.



Agenda

Daikin One+

System Configurations

Installing Daikin One+

Commissioning Daikin One+

Dealer Navigation

Homeowner Navigation

Commissioning Daikin One+

- Start-up screen is displayed upon powering the thermostat.
- The welcome screen displays preferences to choose from.
- Select (P1P2) before moving to the setup screen, the Warning message will show up
- Click “continue” to begin setup.

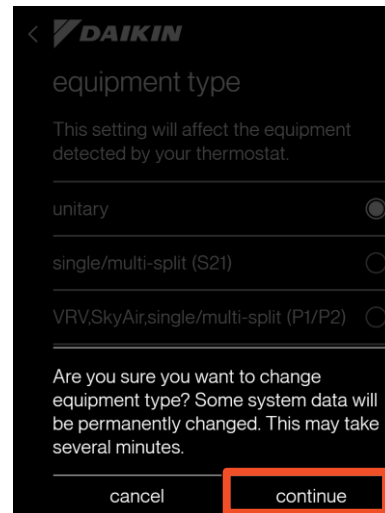

There is a wait time for up to 5 min after clicking continue.

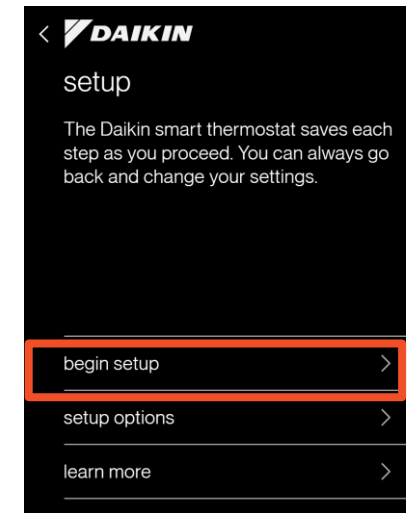
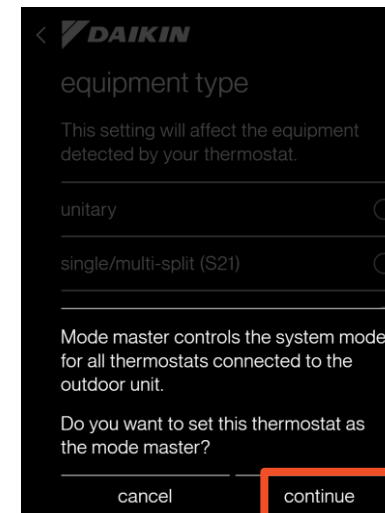
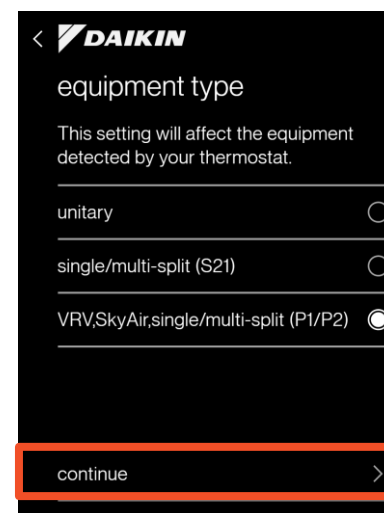

Mode Master/Master controlled

- If the mode master was not selected on the pervious step, The ONE+ will keep requesting to set the changeover mode master indoor unit.

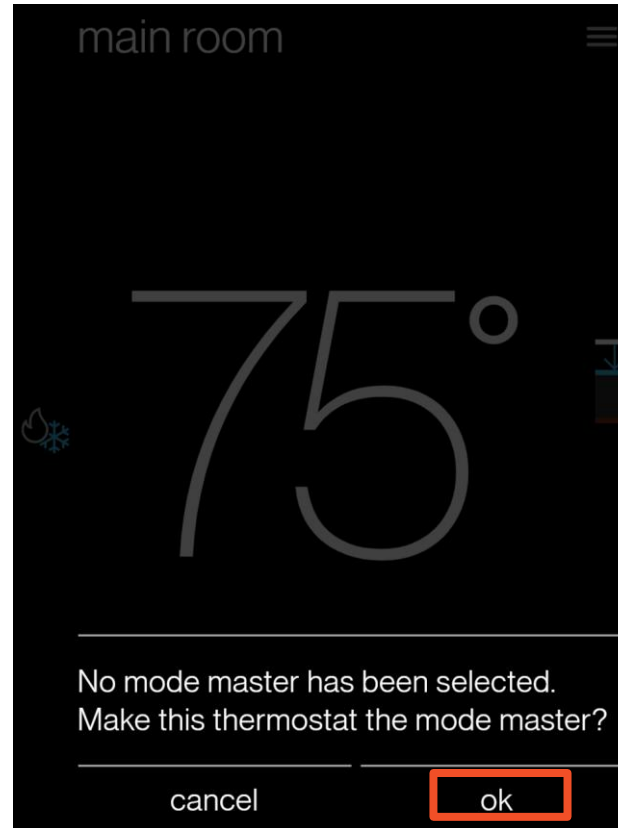

Note: Releasing the changeover mode master from the dealer navigation menu.

This message will keep showing up until the master selected.

Smart thermostat setup

- Starts the five steps set-up process:
 1. Communication.
 2. Personalization.
 3. Equipment Set-up.
 4. System Optimization.
 5. Preferences.
- Note: All steps must be completed and reviewed before completing set-up to ensure the system is configured properly and ready for the homeowner to use.

For detailed menu settings

https://daikinone.com/smart_thermostats/oneplus/pros/

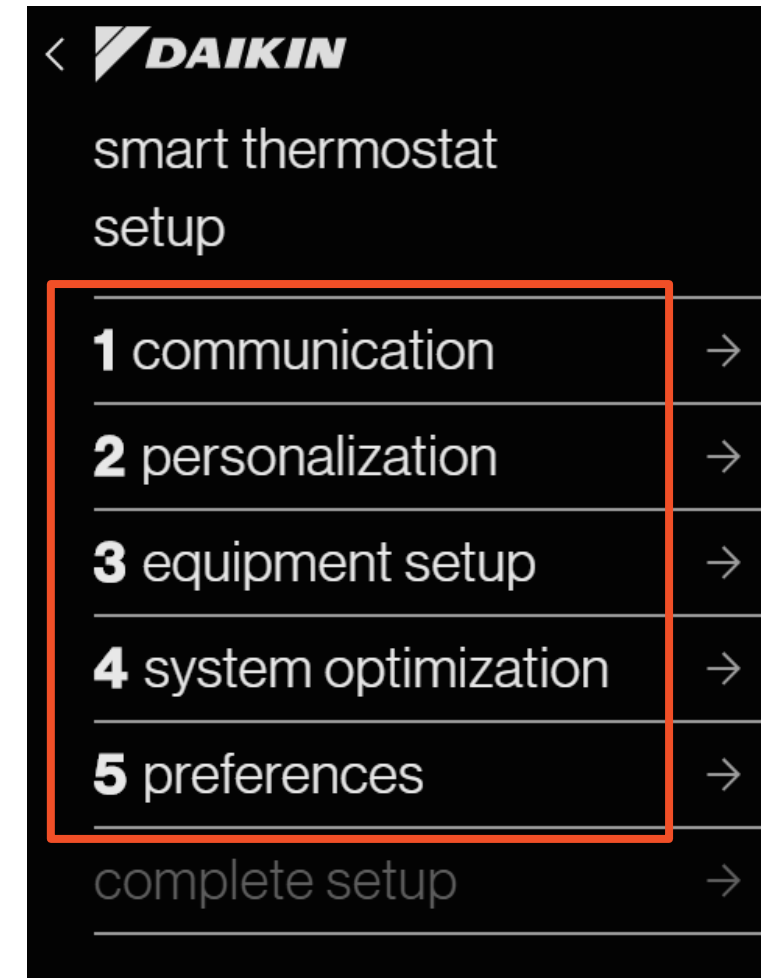

Set-up

Step 1 - Communication

- Configures Communication Networks.
- With Wi-Fi configured, the system can check the software version and update software to the latest version automatically.
- Select home Wi-Fi to search for networks.
- Wireless router must be password protected.
 - Compatible with 2.4Ghz & 5Ghz routers
 - Equipment type displays the equipment selected on start up.
- If there is no Wi-Fi connection:
 - The ONE+ will not receive Over The Air (OTA) updates
 - The AUX heat will not interlock with outdoor temp as it use weather service
 - Date and Time need to be manually configured.

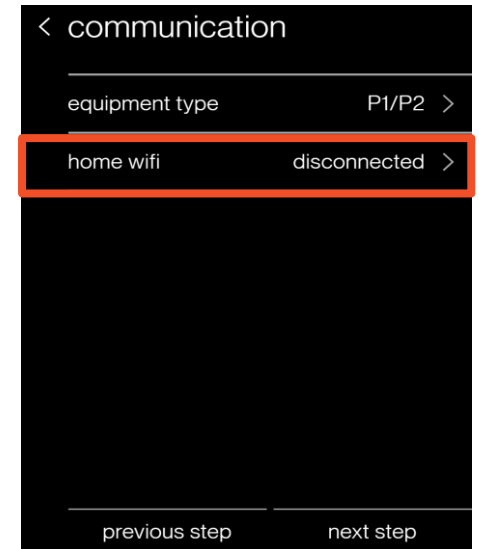

Set-up

Step 2 - Personalization

- Tapping the **personalization tab** allows you to edit default information.
- Personalization displays:
 - Language.
 - English – Spanish - French
 - Large font selection.
 - Date & Time.
 - If Wi-Fi is connected, date & time sets automatically.
 - Thermostat Name.
 - Degree Units.

Note: A green check mark appears next to items reviewed from the set-up menu.

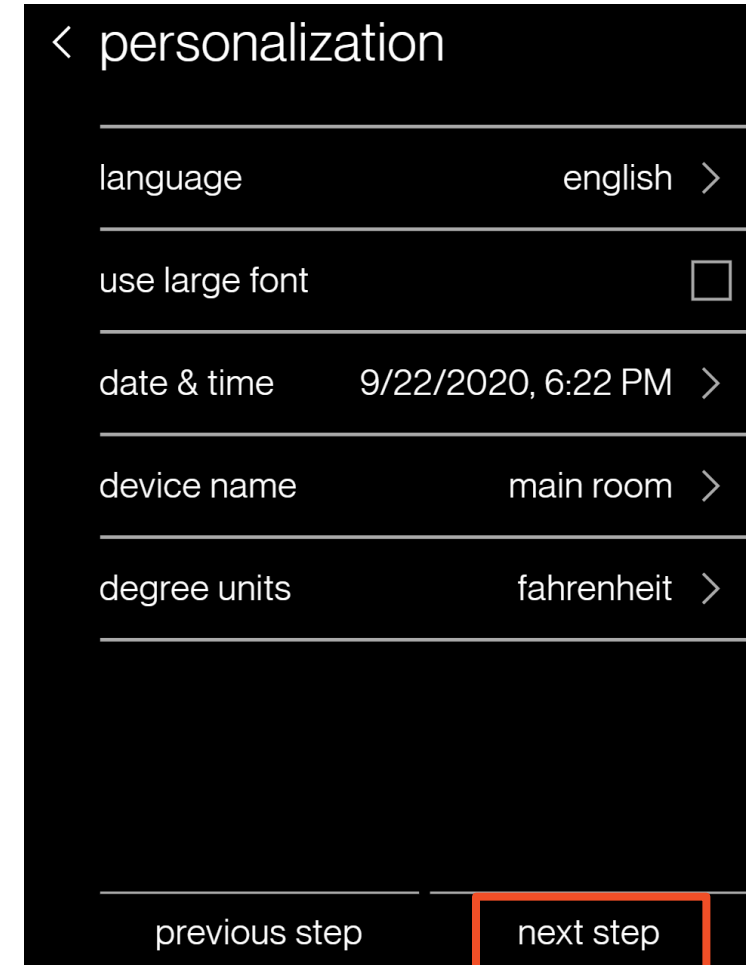
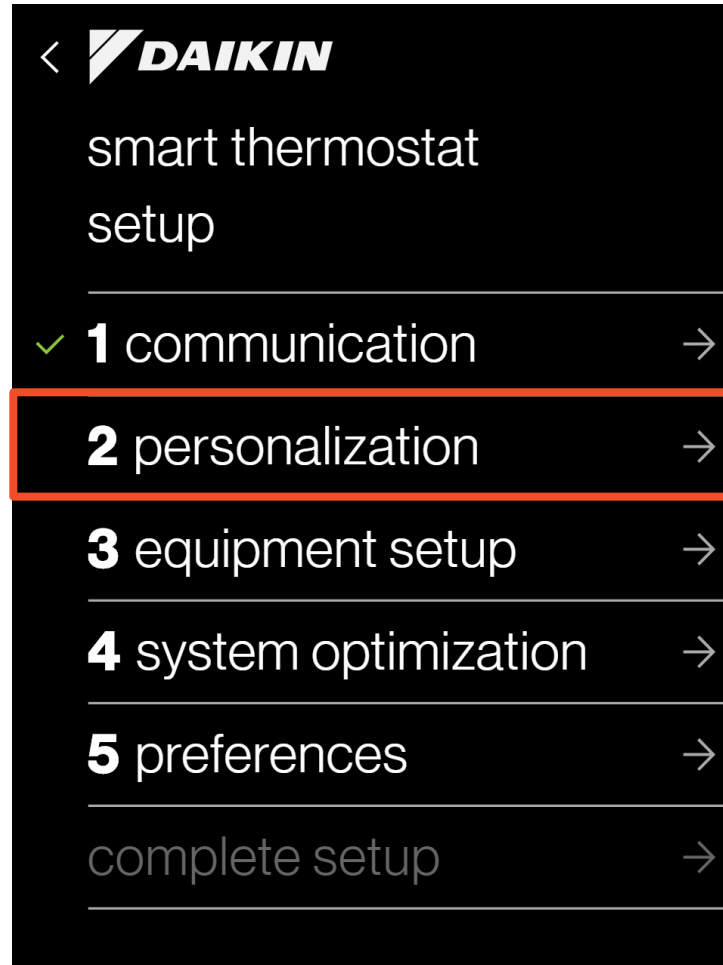

Set-up

Step 3 - Equipment Set-up

- Select Indoor unit Model

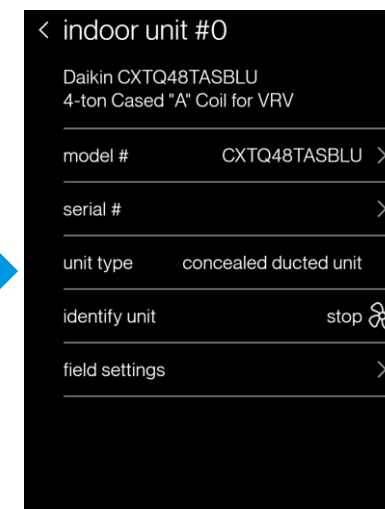
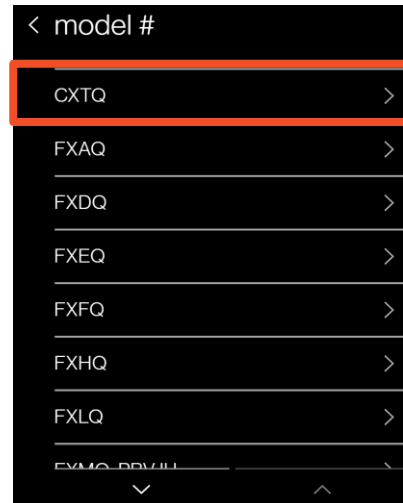
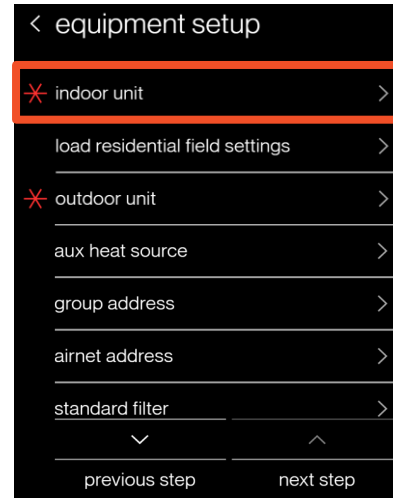
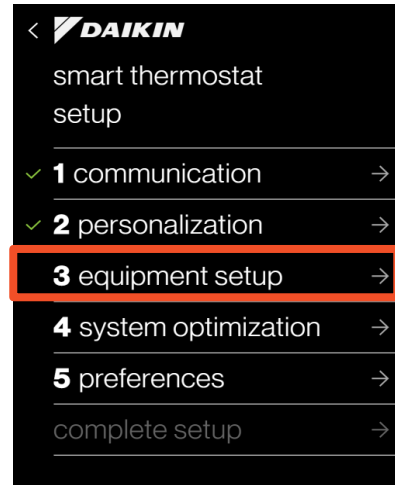

Note: the indoor unit type is automatically identified

Set-up

Step 3 - Equipment Set-up

- Select Indoor unit Model in a group control

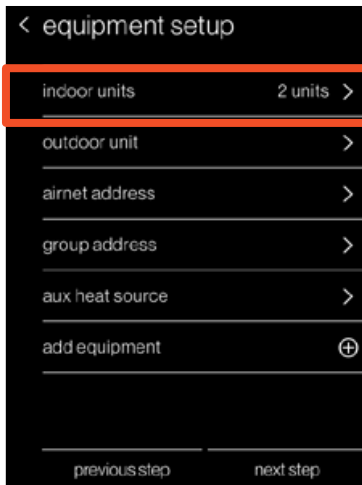
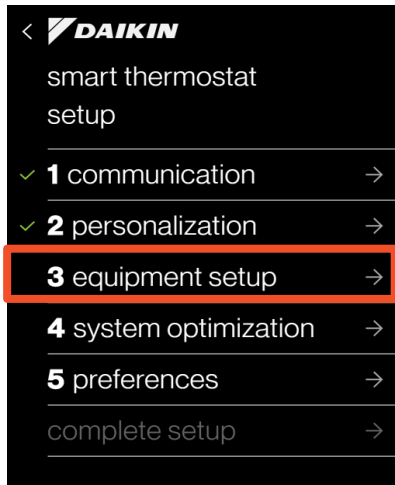

Select indoor unit model#



Identify the indoor unit by force fan on

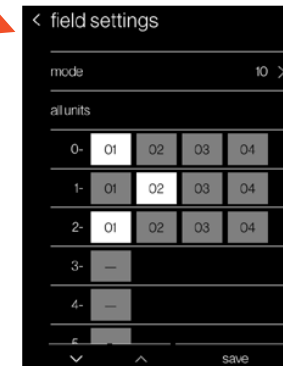

Adjust field settings for group control

Set-up

Step 3 - Equipment Set-up

- Load residential field settings by clicking “next step” or click on “equipment setup”

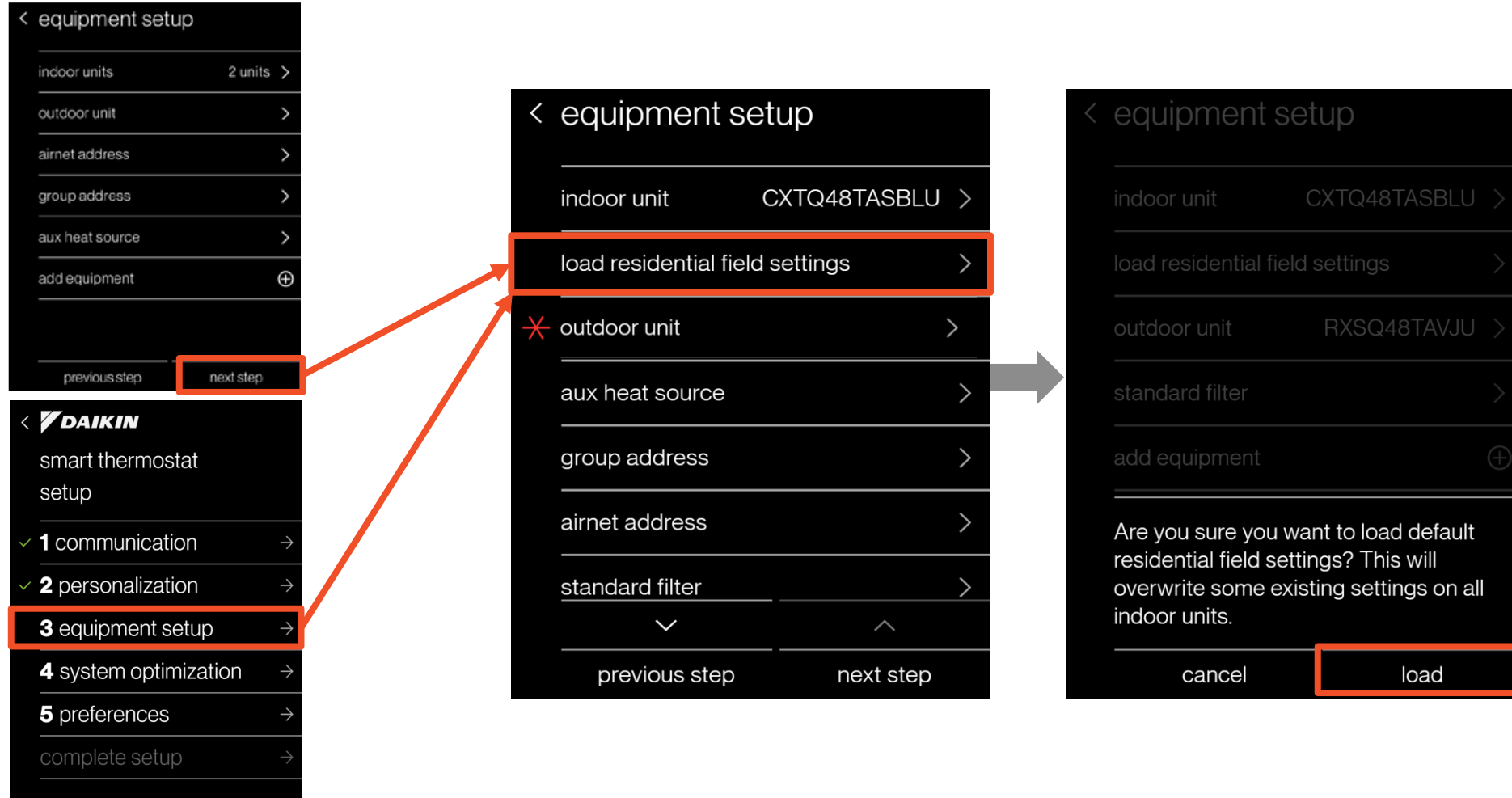

Residential field settings

Step 3 - Equipment Set-up

- When the “**load residential field settings**” action is selected in the UI, the UI writes all residential field setting values (shown in **red** in the table below) to the P1P2 software using a group write (mode 10).

Mode No.	First Code No.	Description	Second Code No.			
			1	2	3	4
10(20)	2	Priority of thermistor sensors for space temperature control	The return air thermistor is primary and the remote controller thermistor is secondary	Only the return air thermistor will be utilized	Only the remote controller thermistor will be utilized	--
	3	Display time to clean air filter calculation (Set when filter sign is not to be displayed)	Display	No Display	--	
	5	Room temperature value reported to multizone controllers	Return air thermistor	Thermistor designated by 10-2 above	--	--
	6	The remote controller thermistor is used in Remote Controller Group	No	Yes	--	--
11(21)	8	Compensation of temperature around human body	Floor sensor does not work	Higher priority on the return air temperature	Standard	Higher priority on the floor temperature
12(22)	2	Thermo-On/Off deadband (Note 4)	2F (1C)	1F (0.5C)	--	--
	3	Fan Speed in Heating Thermo-Off	LL	User set	Off	--
	6	Fan Speed in Cooling Thermo-Off	LL	User set	Off	--
14(24)	5	Dry Mode(FXTQ_TAVJU)	Set Point = Room Temperature	Set Point became same as cooling mode set point	--	--

Change individual field settings

Field settings

- The indoor unit field setting can also be configured by selecting the indoor unit → Field Settings → select mode → select unit number → change the field settings.

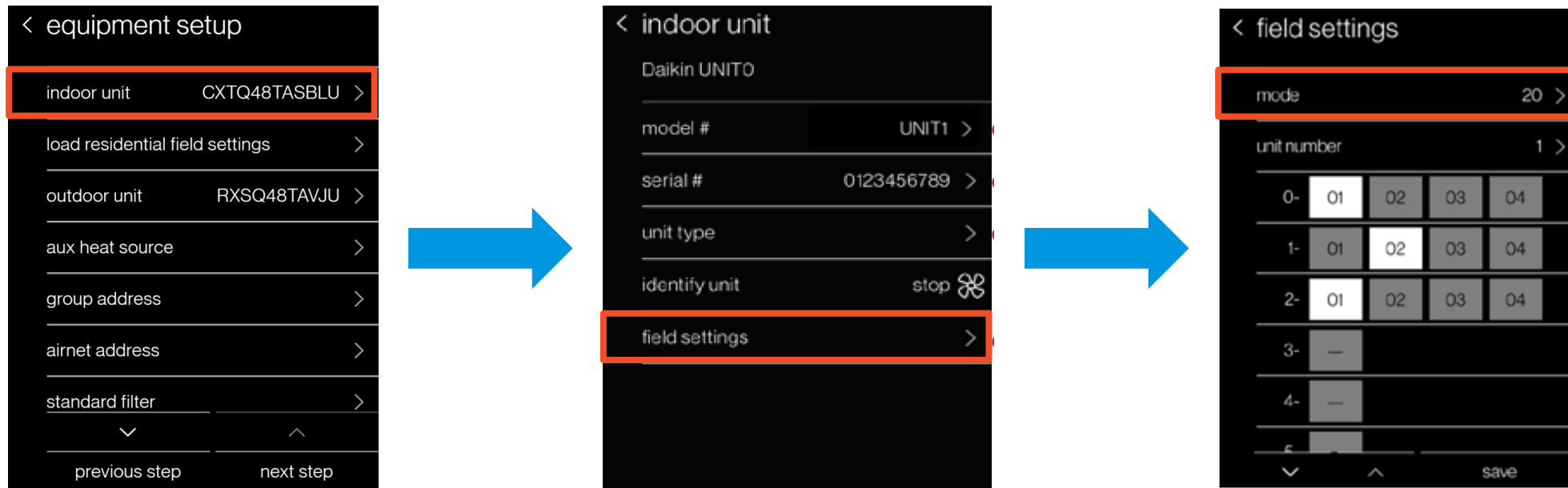

Note: Refer to the field settings table for explanation of the field settings

Field Setting Availability by Indoor Unit Type

Availability of Indoor Unit Field Settings (Control Related) - As of 05/09/2018

- Indoor unit models shaded in grey are obsolete
- Factory default value is indicated in parenthesis.
- Field settings highlighted in orange may not be available in units manufactured before 9/1/2009.
- Field settings highlighted in purple may not be available in units manufactured before 1/1/2007.
- Field settings highlighted in blue may not be available in units manufactured before 1/1/2013.
- Field settings highlighted in green may not be available in units manufactured before 1/1/2015.

Mode No. First Code No.	10						12					
	2	5	6	8	0	1	2 ¹	3	6			
Second Code No.	01	02	03	01/02	01/02	01/02	01/03/04	01/02	01/02	01/02	03	01/02/03
FXSQ_MVJU	X	X	X ³	X ³	X	n/a	X	X	X (02)	X	X ³	X ²
FXSQ_TAVJU	X	X	X	X	X	X	X	X	X (01)	X	X	X
FXMQ_MVJU	X	X	X ²	X ²	X	n/a	X	X	X (02)	X	X ²	X ²
FXMQ72/96MVJU FXMQ_PAVJU FXMQ_PBVJU FBQ_PVJU	X	X	X	X	X	n/a	X	X	X (02)	X	X	X
FXDQ_MVJU	X	X	X	X	X	n/a	X	X	X	X	X	X ⁴
FXTQ_PVJU FTQ_PAVJU FTQ_PBVJU FXTQ_PAVJU FXTQ_TAVJU	n/a	X	X	X	X	n/a	X	X	X (02)	X	X	X
BEQ_MVJLR1(FXOQ)	X	X	X	X	X	n/a	X	X	X (02)	X	X	X ²
FXLQ_MVJU	X	X	X ²	X ²	X	n/a	X	X	X (02)	X	X ²	X ²
FXLQ_MVJU9	X	X	X	X	X	n/a	X	X	X (02)	X	X	X
FXNQ_MVJU	X	X	X ²	X ²	X	n/a	X	X	X (02)	X	X ²	X ²
FXNQ_MVJU9	X	X	X	X	X	n/a	X	X	X (02)	X	X	X
FXAQ_MVJU FAQ_MVJU	X	X	X ²	X ²	X	n/a	n/a	X	X (01)	X	X ²	n/a
FAQ_PVJU	X	X	X ²	X ²	X	n/a	n/a	X	X(01)	X	X ²	X ⁵
FXAQ_PVJU	X	X	X	X	X	n/a	n/a	X	X(01)	X	X	X ⁵
FXZQ_M7VJU	X	X	X ²	X ²	X	n/a	X	X	X (01)	X	X ²	X ²
FXZQ_MVJU9	X	X	X	X	X	n/a	X	X	X (01)	X	X	X
FXZQ_TAVJU	X	X	X	X	X	X	X	X	X(01)	X	X	X
FXFQ_MVJU FCQ_MVJU FCQ_PVJU	X	X	n/a	n/a	n/a	n/a	X	X	X (01)	X	n/a	n/a
FXFQ_PVJU FCQ_PAVJU FXFQ_TVJU	X	X	X	X	X	X	X	X	X (01)	X	X	X
FXHQ_MVJU FHQ_PVJU FHQ_MVJU	X ⁵	X	X ⁵	X ⁵	X ⁵	n/a	X	X	X (01)	X	X ⁵	X ⁵
FXUQ_PVJU	X	X	X	X	X	X	n/a	X	X(01)	X	X	X
FXEQ_PVJU	X	X	X	X	X	n/a	X	X	X(01)	X	X	X
CXTQ_TASBLU	X	X	X	X	X	X	X	X	X(01)	X	X	X

Field Settings Indoor Units

Mode No. (Note 1)	First Code No.	Description	Second Code No. (Note 2) (Cells in bold are factory default settings)			
			01	02	03	04
10(20)	2	Priority of thermistor sensors for space temperature control	The return air thermistor is primary and the remote controller thermistor is secondary.	Only the return air thermistor will be utilized.	Only the remote controller thermistor will be utilized.	--
	5	Room temperature value reported to multizone controllers	Return air thermistor	Thermistor designated by 10-2 above (Note 3)	--	--
	6	The remote controller thermistor is used in Remote Controller Group	No	Yes	--	--
12(22)	0	KRP1B71 X1-X2 status output	Indoor unit Thermo-On/Off status	--	Indoor unit Operation On/Off status	Indoor unit Alarm status
	1	Indoor unit T1-T2 input	Forced Off Closed Contact-Indoor unit is forced off and Central Control icon is displayed. Unit cannot be turned on manually. Operation can be overridden by central control. Open Contact-Indoor unit can resume normal operation. Unit must be turned on manually or by central control.	On/Off Closed Contact-Indoor unit is turned on. Open Contact-Indoor unit is turned off. Unit responds to last command, i.e., unit can be turned on manually or by central control after circuit has opened. Operation is prohibited when remote controller On/Off control is restricted by a multizone controller.	External Protection Device Closed contact-Unit shall resume normal operation. Open contact-Unit shall shut down and generate an A0 error.	
	2	Thermo-On/Off deadband (Note 4)	2F (1C)	1F (0.5C)	--	--
	3	Fan Speed in Heating Thermo-Off	LL	User set	Off	--
	6	Fan Speed in Cooling Thermo-Off	LL	User set	Off	--
	8	Return air sensor offset	2C	None (for remote sensor)		

1. Field settings are normally applied to the entire remote control group, however if individual indoor units in the remote control group require specific settings or for confirmation that settings have been established, utilize the mode number in parenthesis.
2. Any features not supported by the installed indoor unit will not be displayed.
3. When mode 10-2-01 is selected, only the return air temperature value is reported to the multi-zone controller.
4. The actual default dead band value will depend upon the indoor unit model.

Set-up

Step 3 - Equipment Set-up

- Select outdoor unit

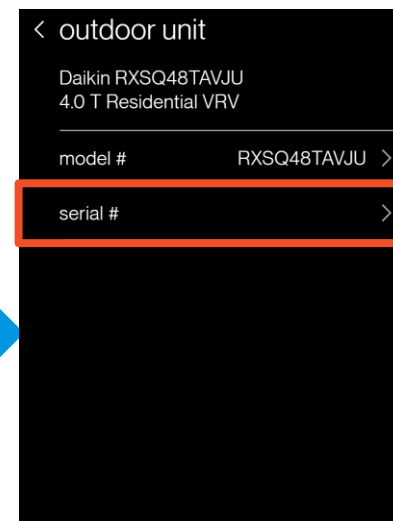
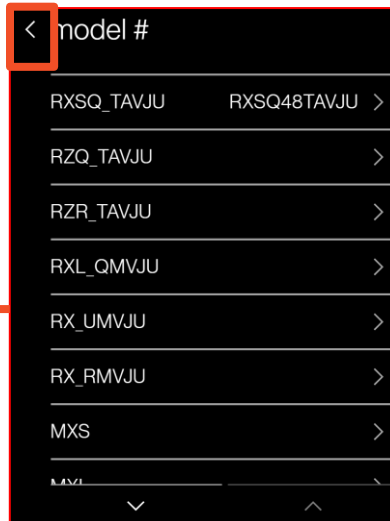
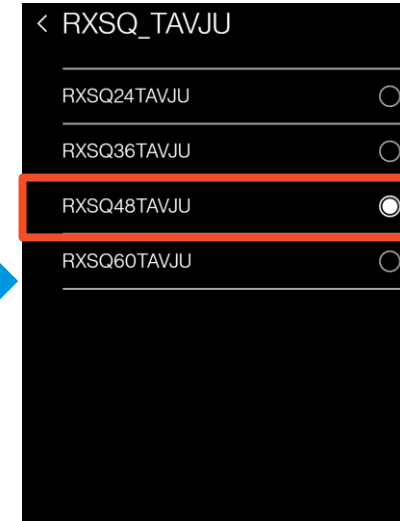
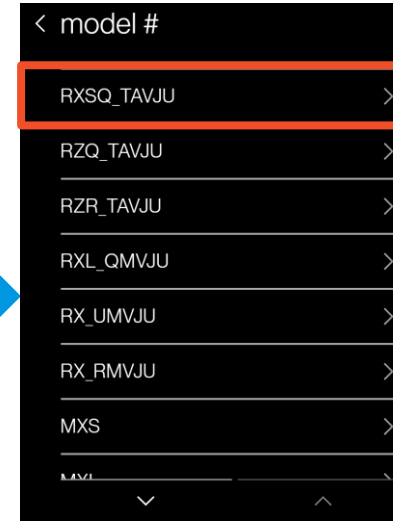
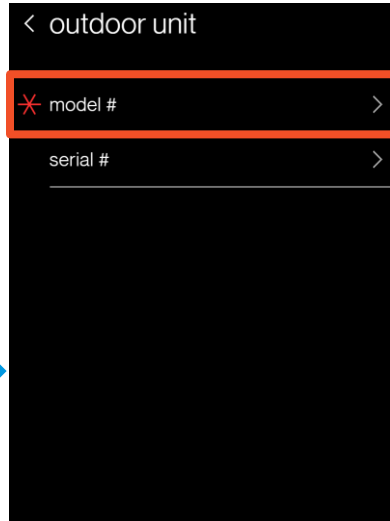
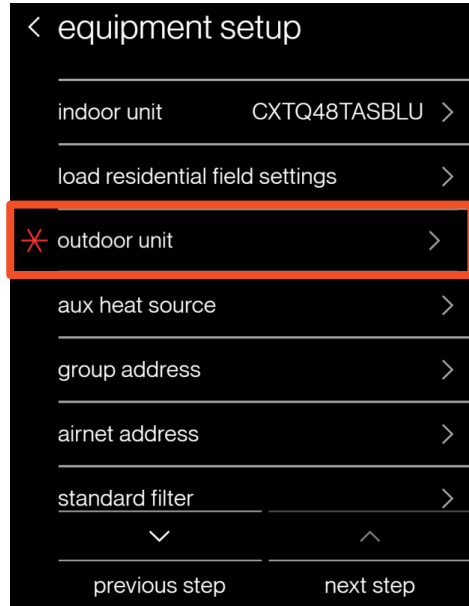

Note: If the outdoor unit is not shown in the list, select the down arrow then “others” menu, then manually type the outdoor unit model.

Set-up

Step 3 - Equipment Set-up

- The AUX heat can be setup as primary or the secondary source of heat. Once it setup, the Emergency heat mode will also be added to the operational mode menu.

- Setup **“aux heat source”**

- Click on Add equipment / aux heat source
- Select Connection: select aux1 or aux 2 based on Wiring connection to AUX heater
- Default: heat pump is primary heat source.
- Select control to adjust parameters

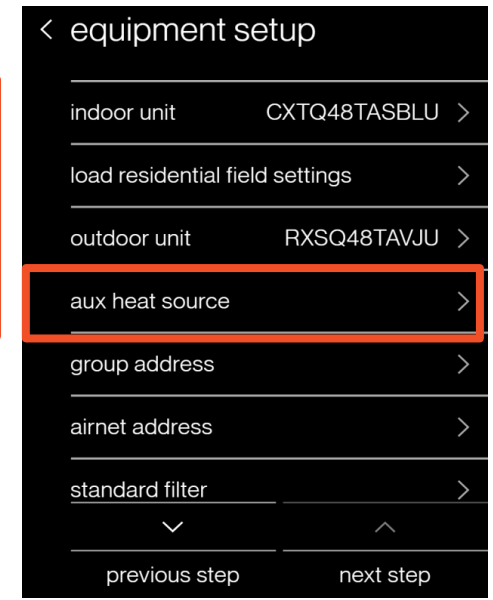
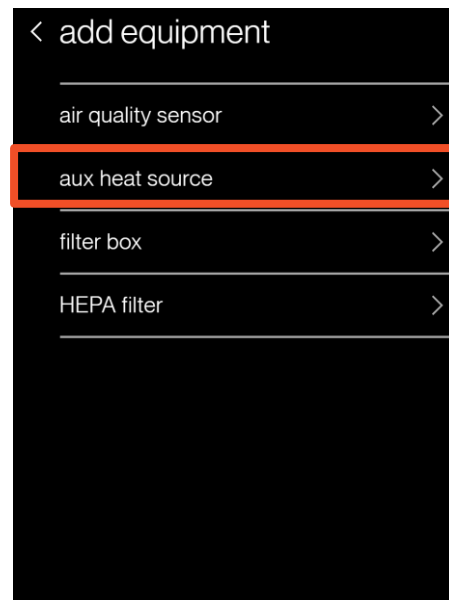
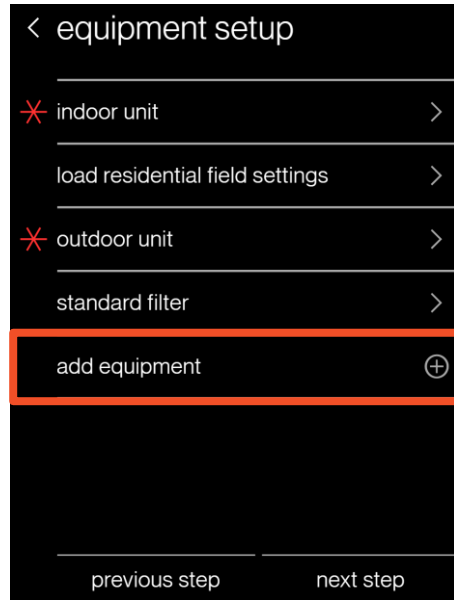
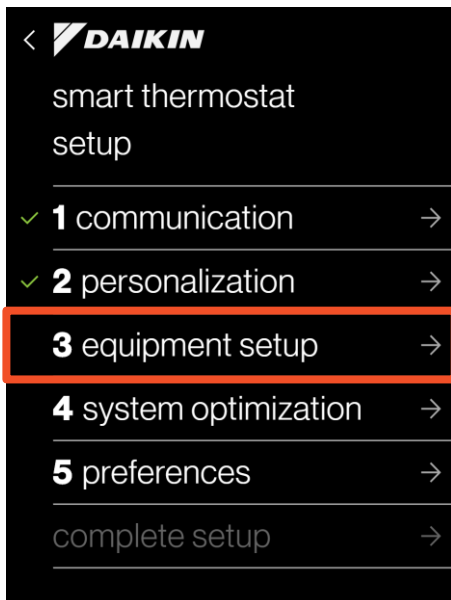

Set-up

Step 3 - Equipment Set-up

- Heat pump is primary heat source
 - Note: the heat pump lockout and the aux heat lockout are based on the ambient temperature data. The Ambient temperature data is communicating to the ONE+ through the **weather service**, therefore the Wi-Fi connection is necessary for aux heat logic to execute.

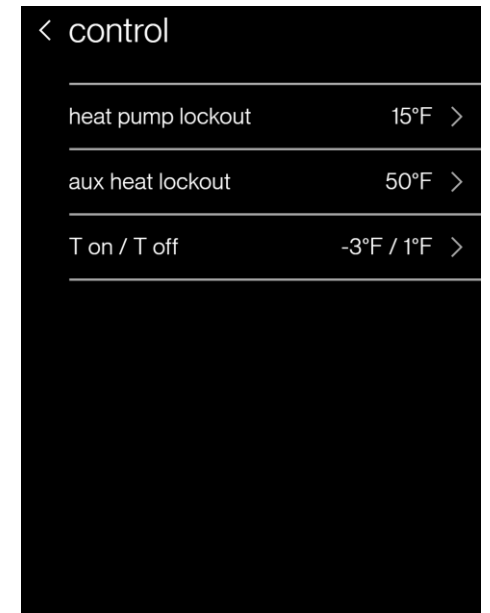
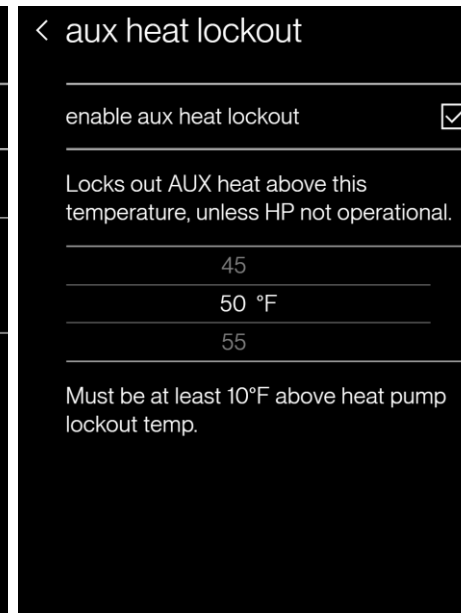
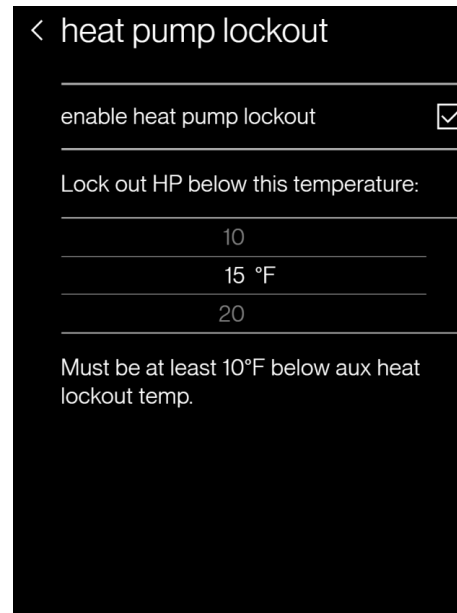
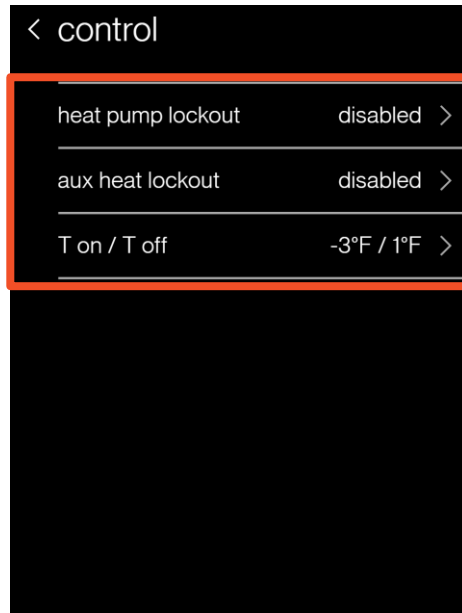
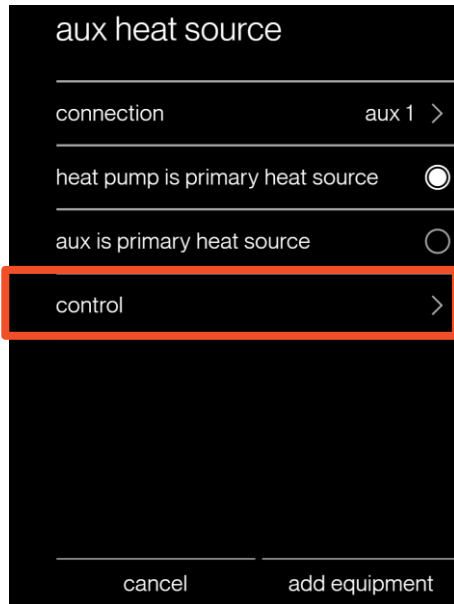

Set-up

Heat pump is primary heat source

- Heat pump lockout adjustable from -20°F to 65°F in 5°F increments. (default: 15°F)
- Aux heat lockout adjustable from -10°F to 75°F in 5°F increments. (default: 50°F)
- Aux heat demand
 - Ton differential -7°F to -3°F in 1°F increments (default -3°F)
 - T off differential -4°F to 1°F in 1°F increments (default 1°F)

Note: The Aux heater can be setup to turn off below, at, or above the heat setpoint.

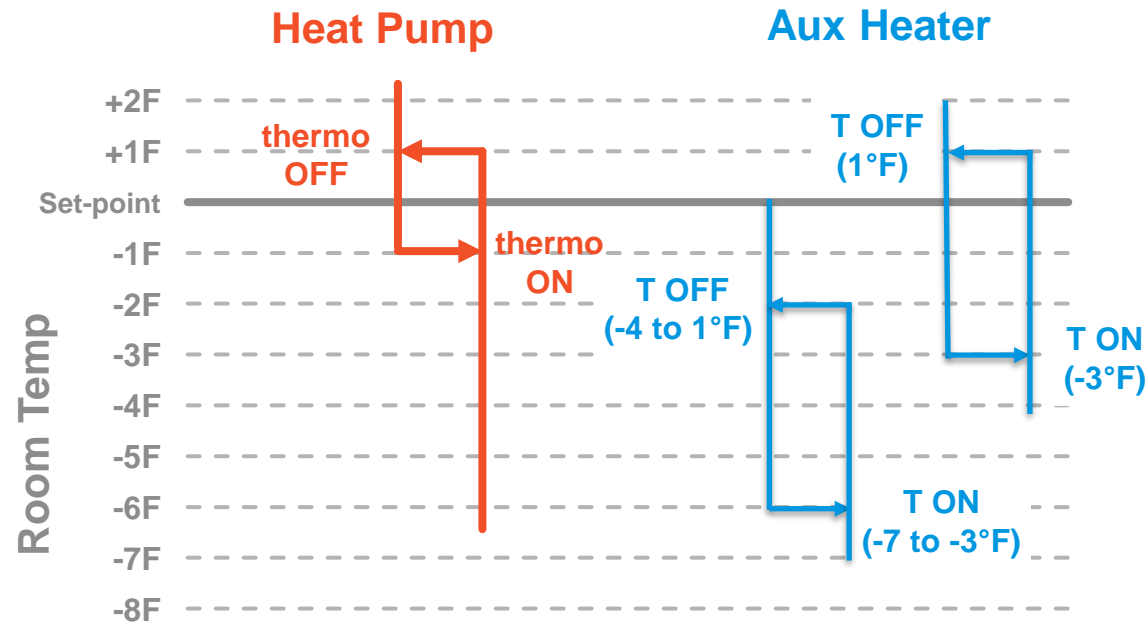

Set-up

Step 3 - Equipment Set-up

- Aux is primary heat source

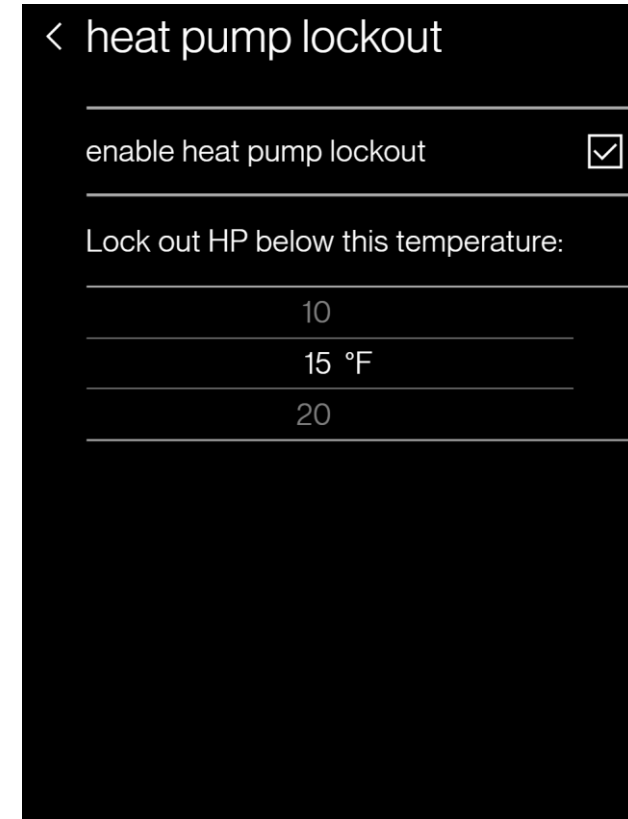
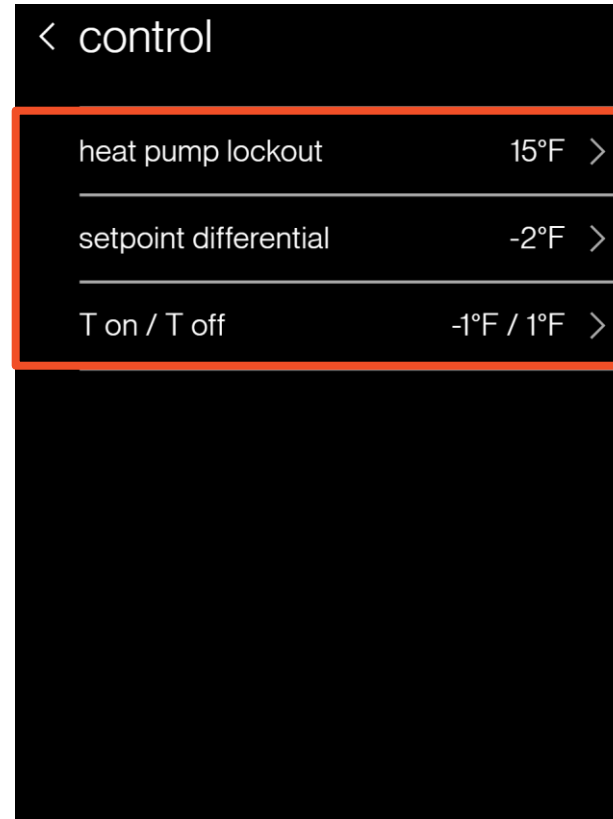

Set-up

Aux heat is the primary heat source

- Heat pump lockout adjustable from -20°F to 65°F in 5°F increments. (default 15°F)
- Setpoint differential -9°F, -7°F, -4°F, and -2°F (default -2°F)

Aux heat demand

- Ton differential -1°F to -2°F (default -1°F)
- Toff differential 1°F fixed

Note: When the Aux heater is engaged; the P1P2 indoor unit will:

- Turn ON
- Heat mode (thermo-off)
- Fan follows field settings 12(22) 3
- IDU setpoint = display setpoint – setpoint differential

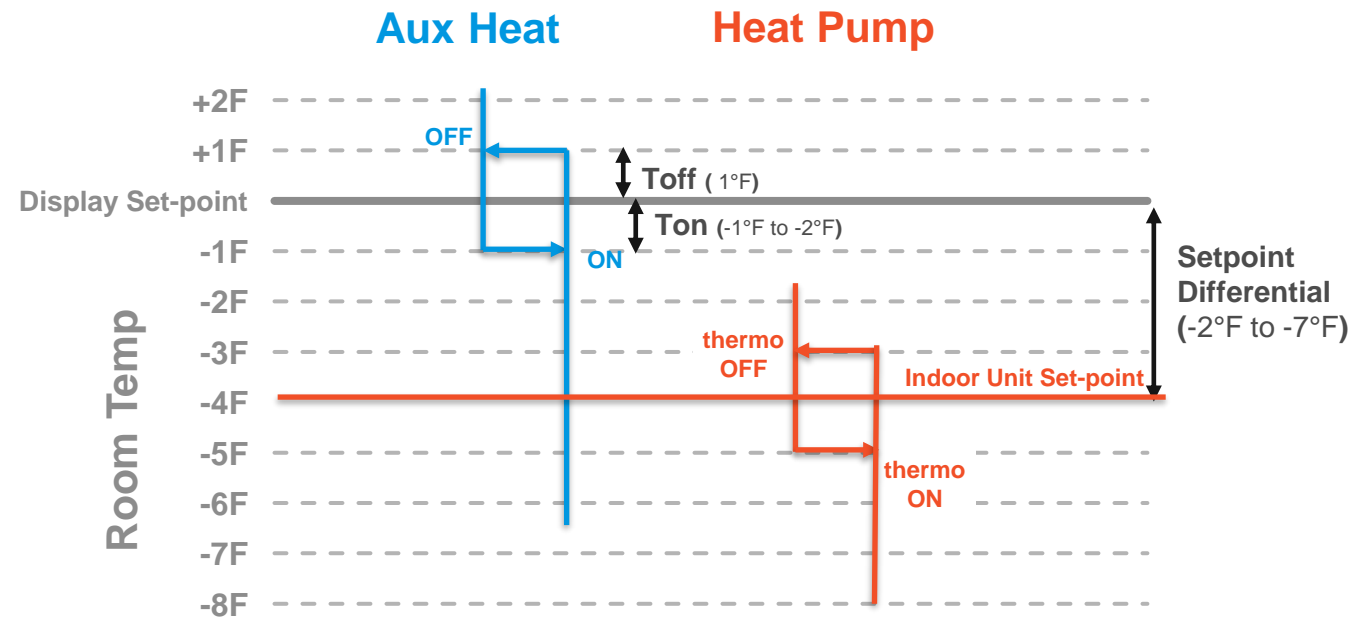

Set-up

Emergency heat:

- Once the Aux heat is set, The user will be allowed to turn on Emergency heat from the system mode menu regardless if the indoor unit is mode master or master controlled.

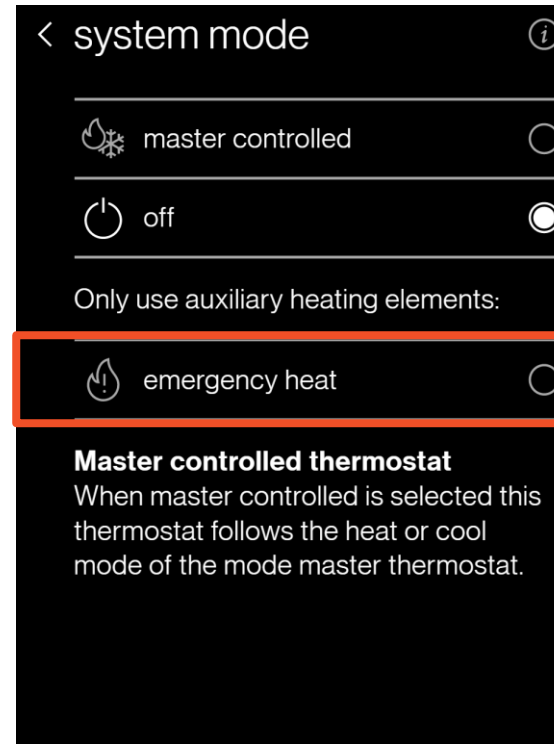
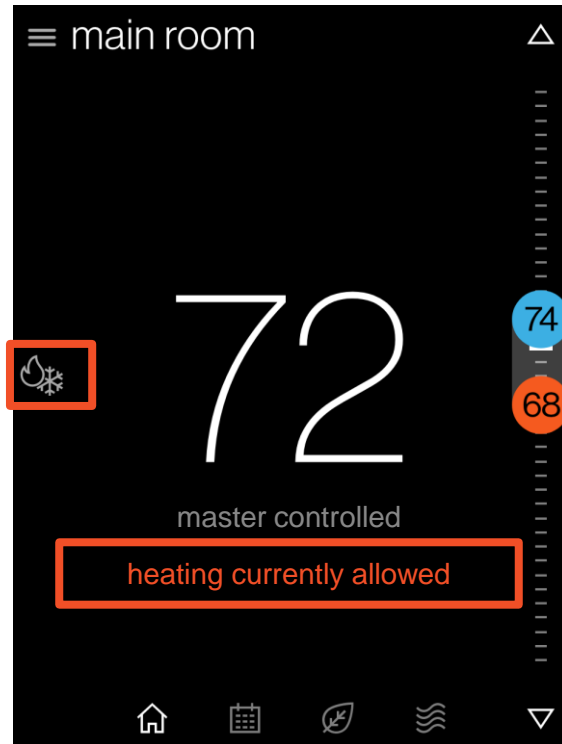

Note: The Emergency Heat mode will engage the AUX heater contact ONLY, however the IDU and the Fan will be OFF.

Group Addressing

- Required for multi-zone controllers
- 64 group addresses (up to 128 indoor units) can be assigned per iTM/BMS Gateways via the remote controller
- Addresses cannot be duplicated on the same DIII-Net communication bus
- Address numbers assigned to indoor units are:

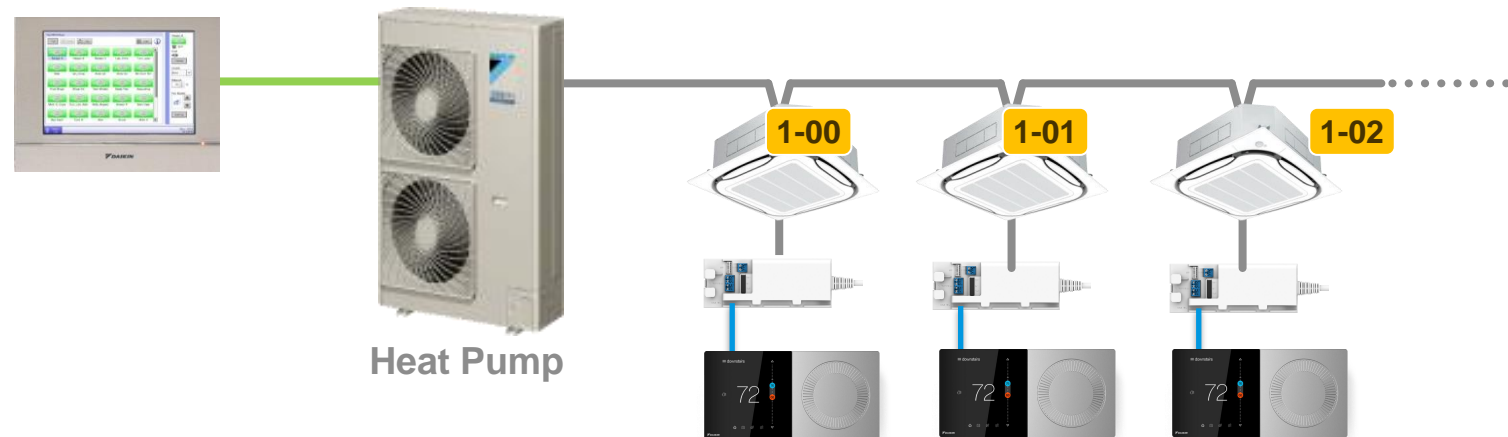
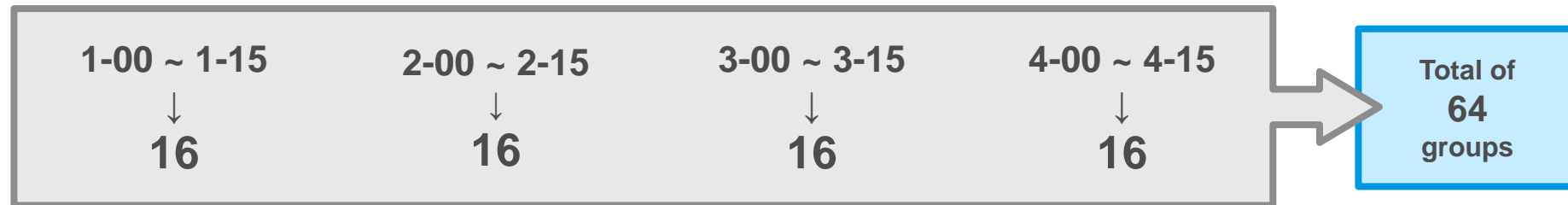

Set-up

Step 3 - Equipment Set-up

- Set the indoor unit group address
 - In case if multiple indoor unit in a group control, one group address can assign to all of them by using “assign same”
 - Select assign individually

- Choose a group address:
 - 1-00 : 1-15 2-00 : 2-15 3-00 : 3-15
4:00 : 4:15
- Click “Save”

Note: the group address menu will show up only if a central controller (iTM, Service checker...etc. is connected to the DIII-Net.

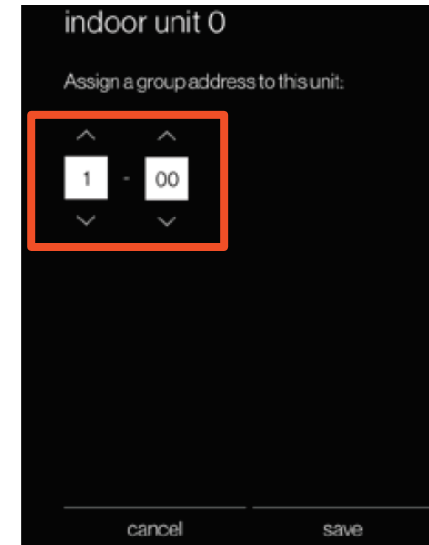
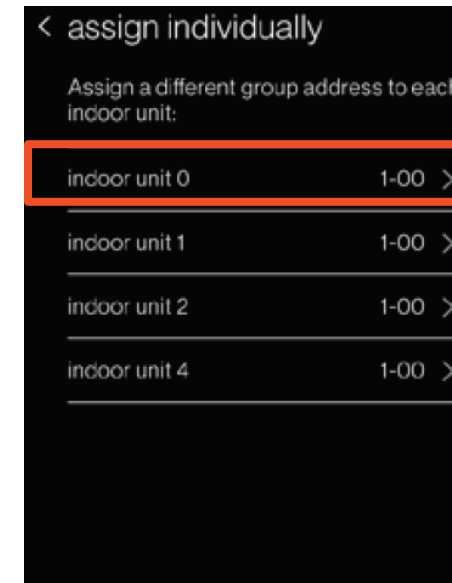
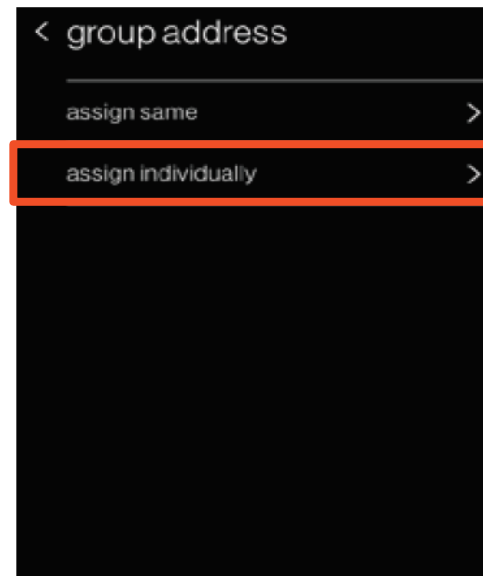
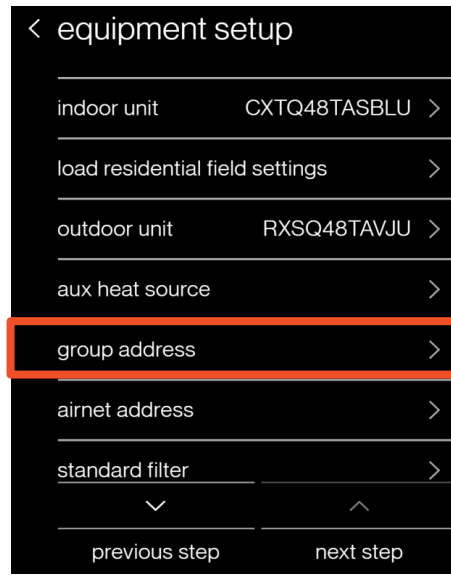
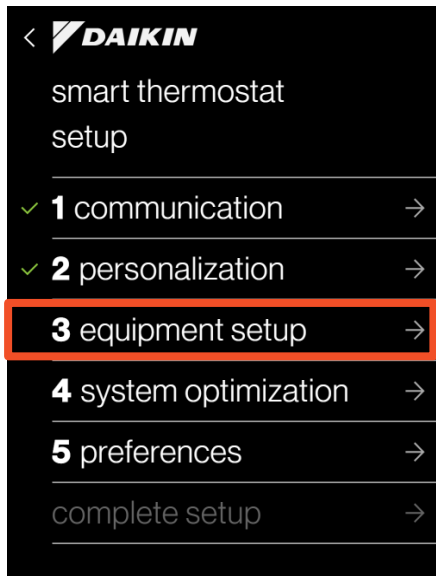

AirNet Address

- The AirNet address used in:
 - Identify the indoor unit when using service checker
 - VRV Operational data through the iTM
 - VRV D-Net service (remote monitoring service)
- Outdoor unit address range 1-31 set via outdoor unit control PCB
- Indoor unit address range 2-128 set via remote controller
- Duplicate AirNet address between indoor and outdoor units is allowed.

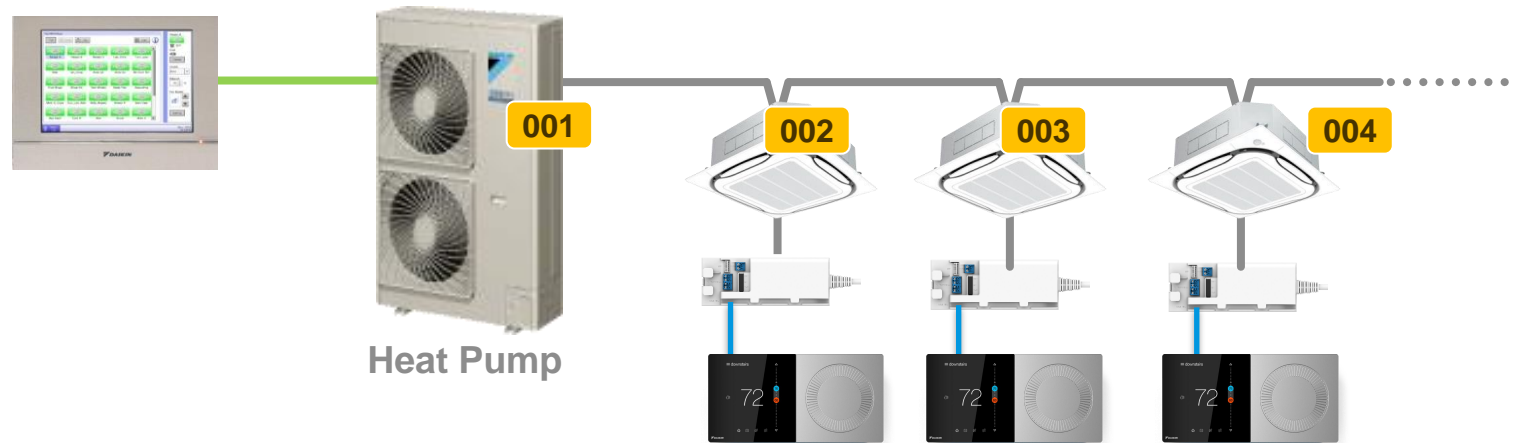

Set-up

Step 3 - Equipment Set-up

- Set the Airnet Address for indoor and outdoor unit
 - Indoor unit (1-128)
 - Outdoor airnet address (1-63)

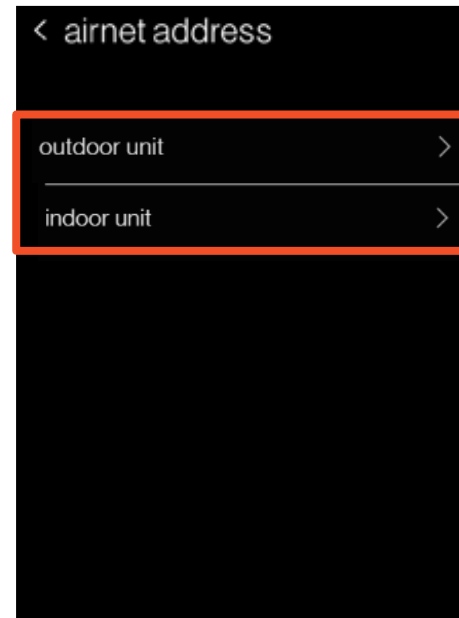
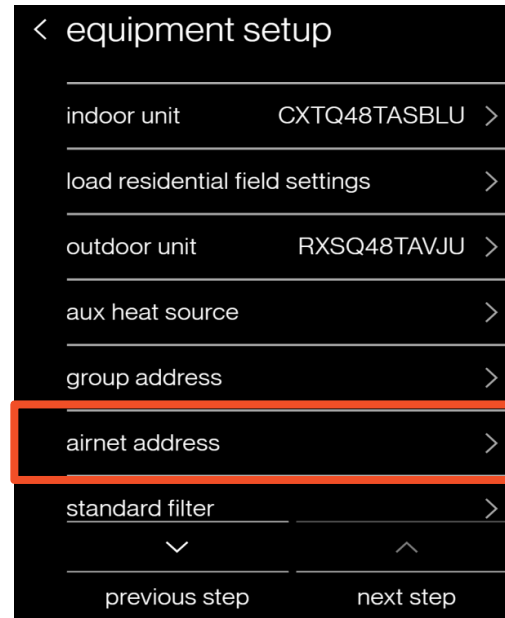
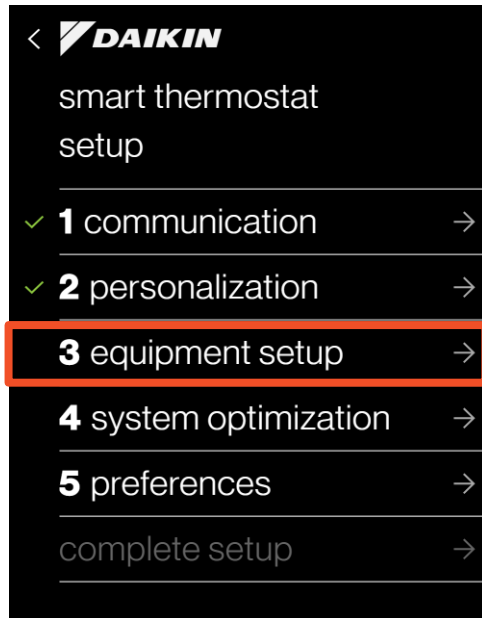

Set-up

Step 4 – System Optimization

- System optimization displays:
 - Optional test
 - Error history
 - Logs alerts with an error code.
 - Calibration (**Thermostat must be in OFF mode**)
 - **Wait 30 minutes before calibration for the thermostat to equalize.**
 - Status
 - The status menu displays data for unit #0 Only.

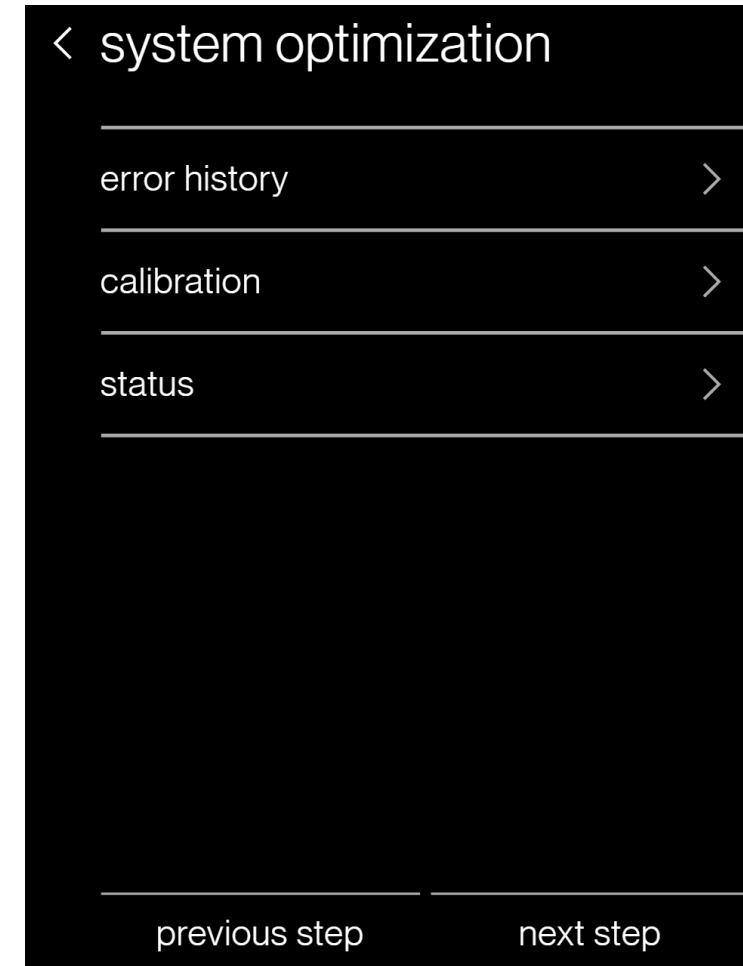
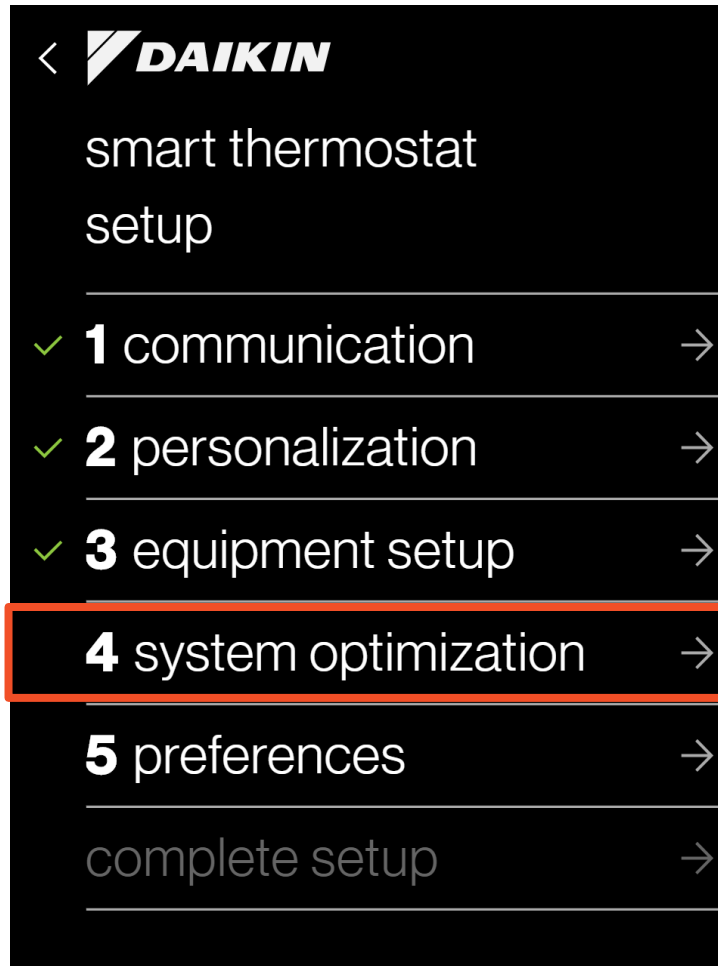



Step 4 – System Optimization

- Error history.
 - Logs alerts with an error code.
 - White = not critical
 - Yellow = critical
 - “Clear History” will clear the history log.

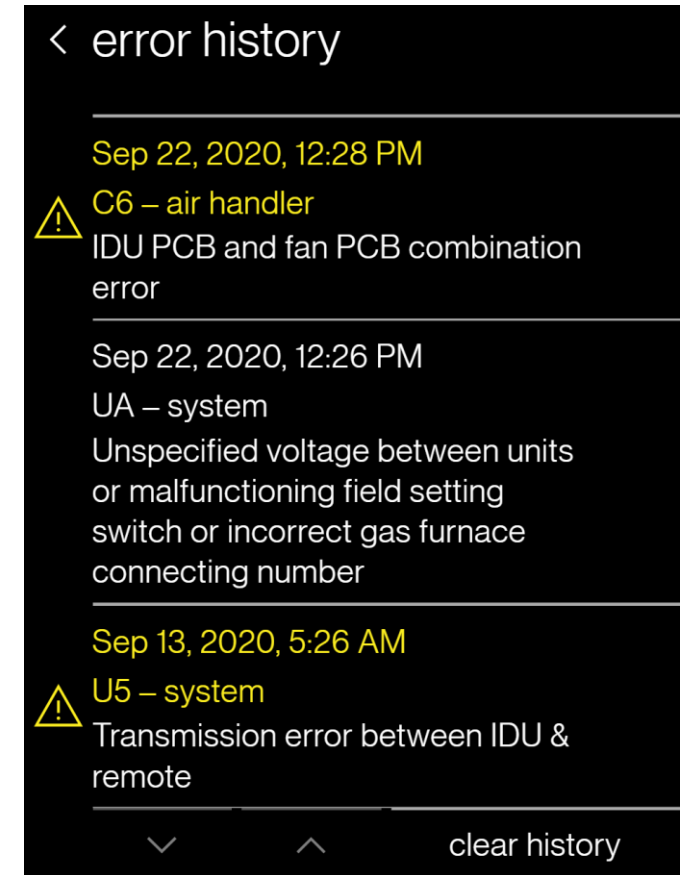
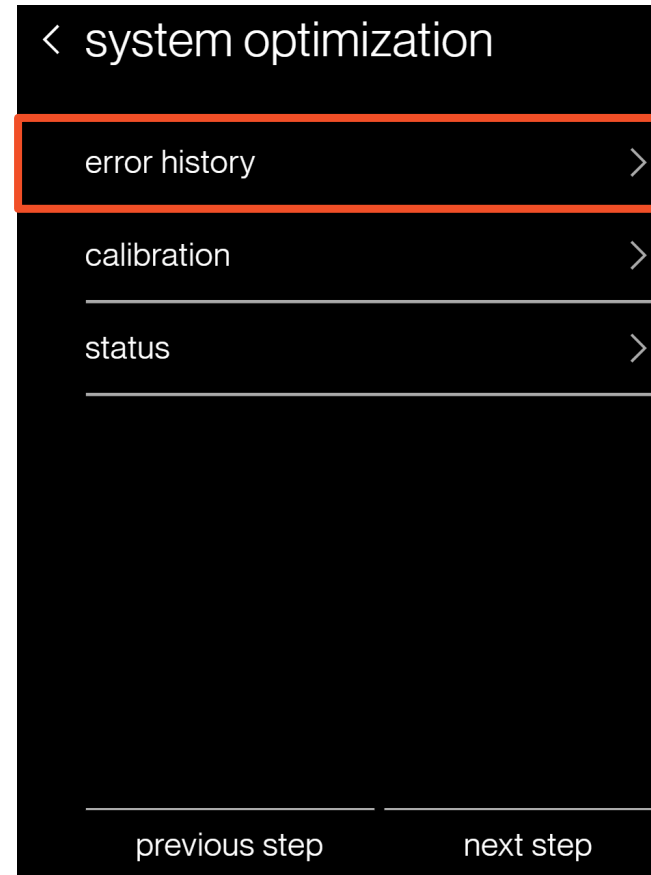

Set-up

Step 4 – System Optimization

- Calibration → Offsets the One+ thermistors temperature/humidity measurements
 - Offset temperature $\pm 7^{\circ}\text{F}$ (default 0°F)
 - Offset relative humidity $\pm 15\%$ (default 0%)

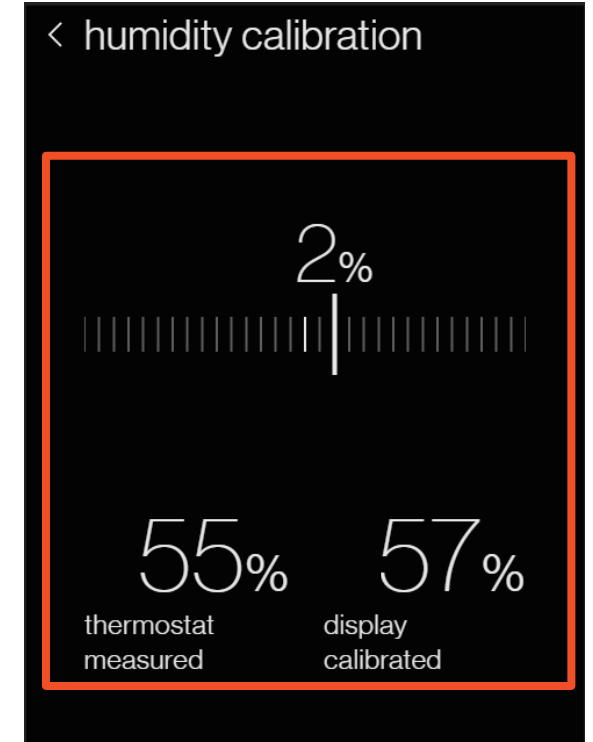
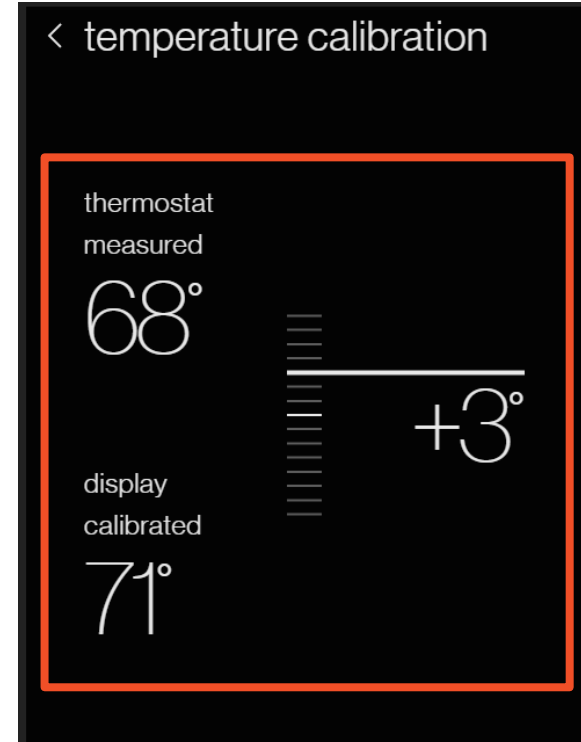
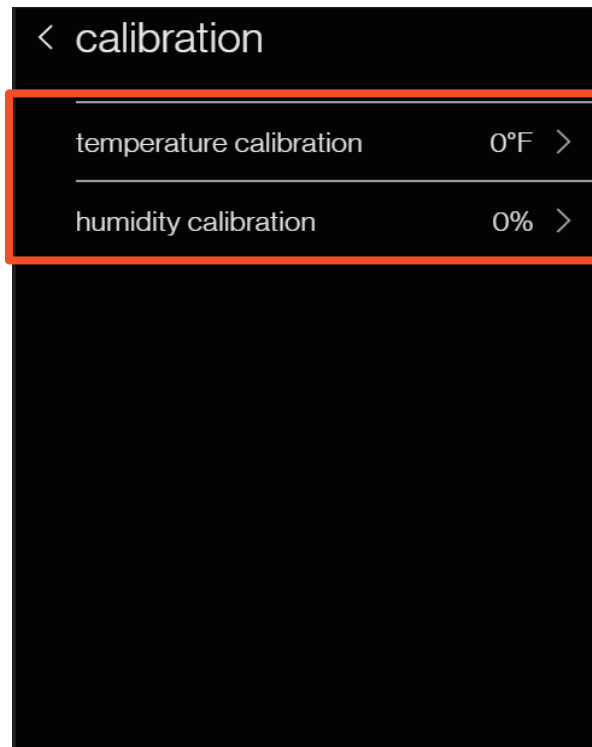
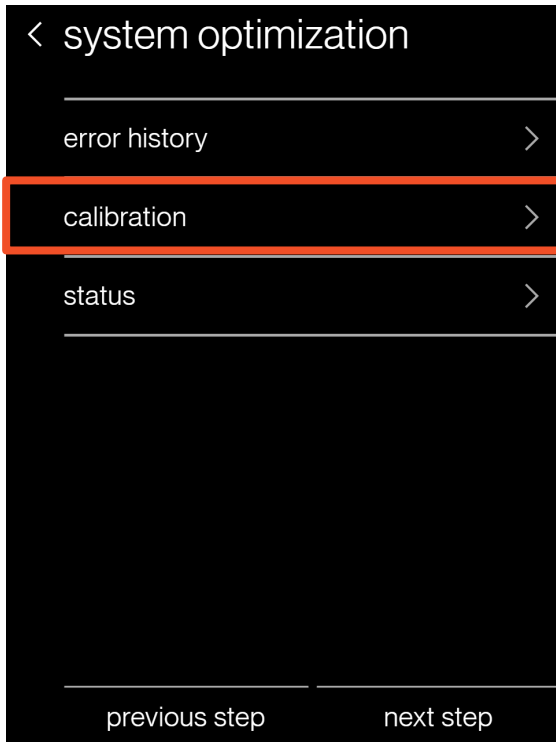

Note: The system needs to be in the “off” mode during the calibration

Set-up

Step 4 – System Optimization

- Status
 - To view the indoor and outdoor unit data
 - The displayed data depends on the indoor unit type

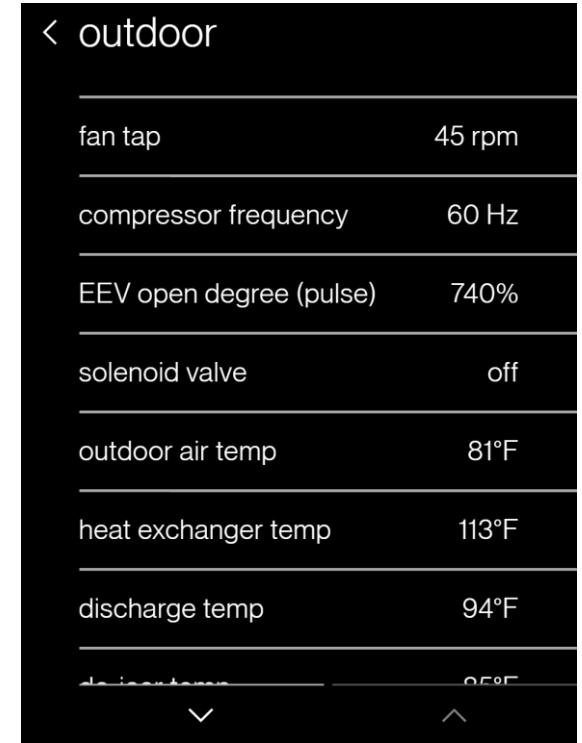
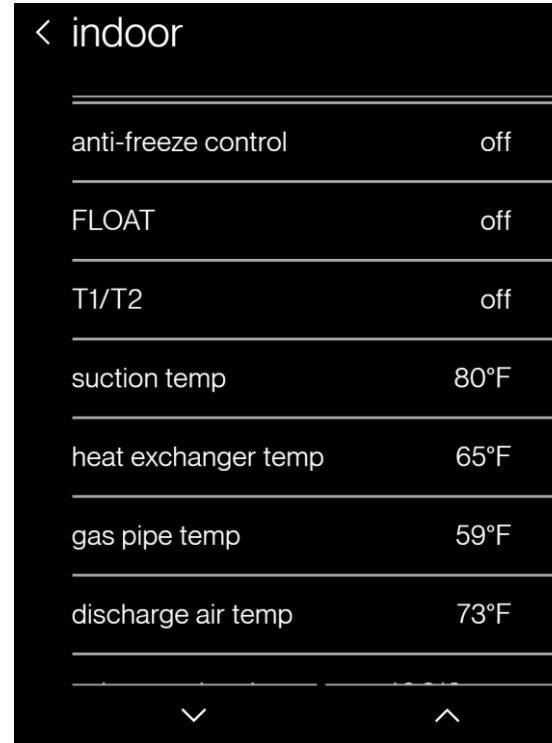
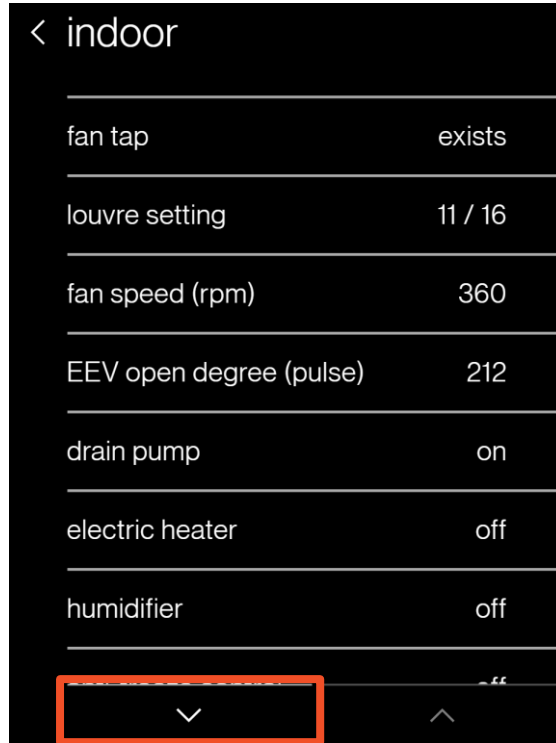
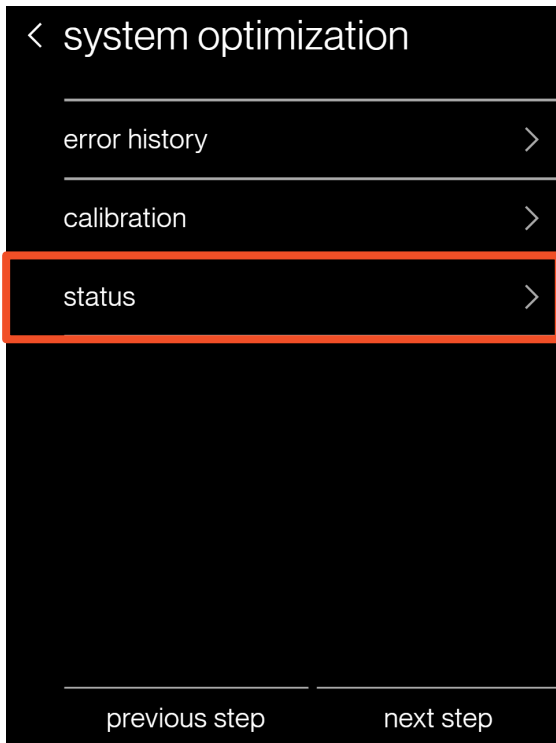

Click on the down arrow to view more data

Set-up

Step 5 - Preferences

- There are four preference settings to choose from in order to optimize your systems performance.
 - Cool/Heat
 - House settings
 - Dealer information
 - Reminders
- Note:
 - Dealer contact information and reminders should be inputted.
 - The homeowner cannot edit service reminders.

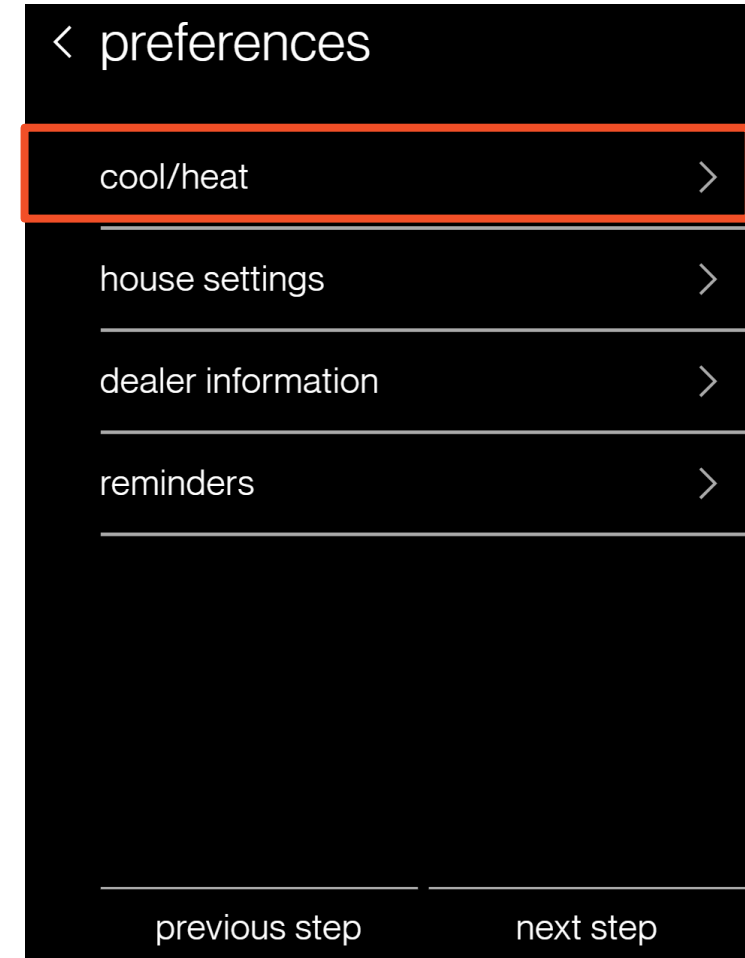
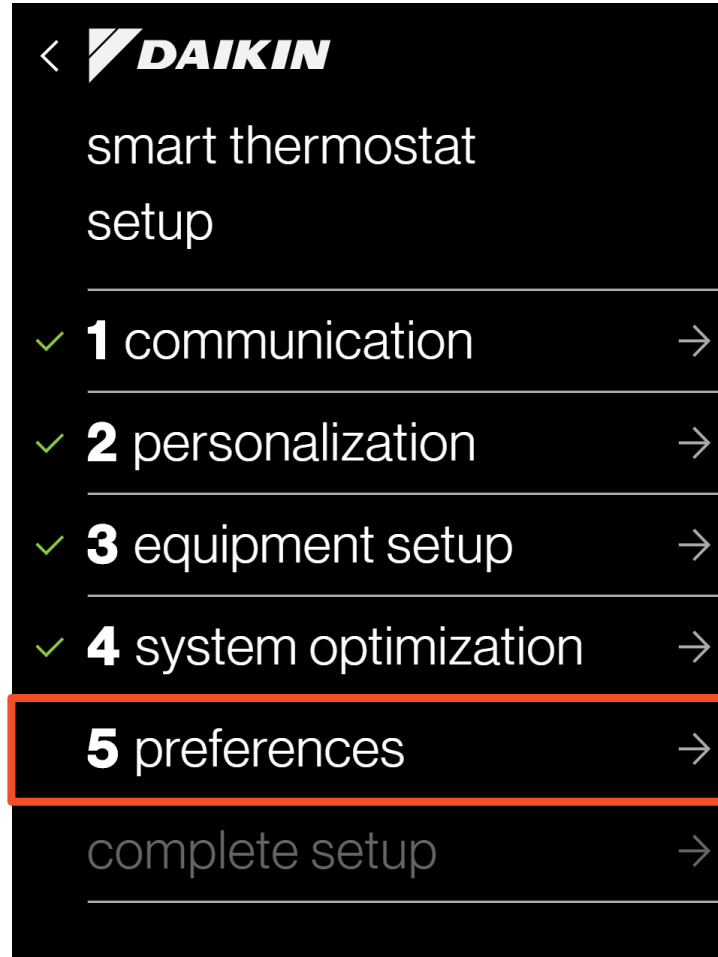

Set-up

Step 5 - Preferences

- Cool/heat:
- Min/max setpoints:
 - Min/max set points in 1°F increments:
 - Default: 61 to 90°F

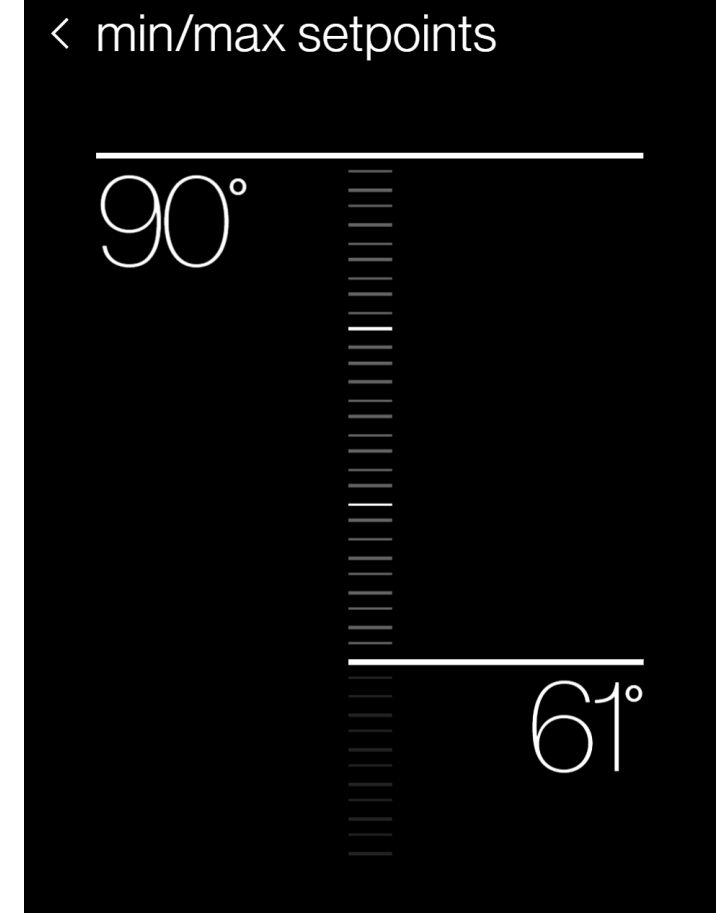
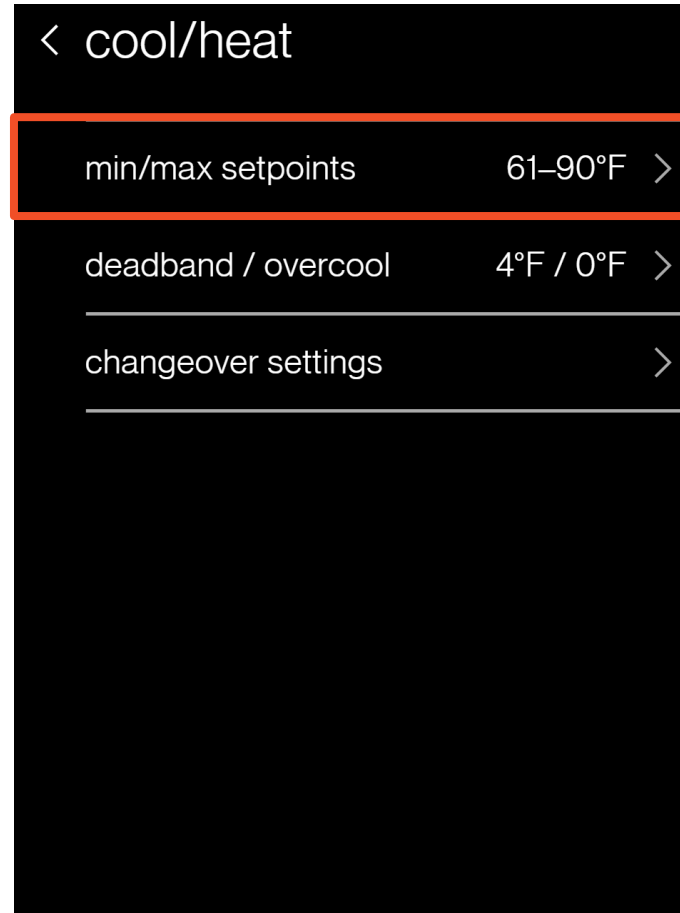

Set-up

Step 5 - Preferences

- Cool/heat:
- Deadband
 - Minimum differential between cooling and heating set point in auto mode.
 - Default: 4°F
 - 2 to 9°F in 1°F increments
- Overcool
 - Default: 0°F
 - 0 to 3°F in 1°F increments

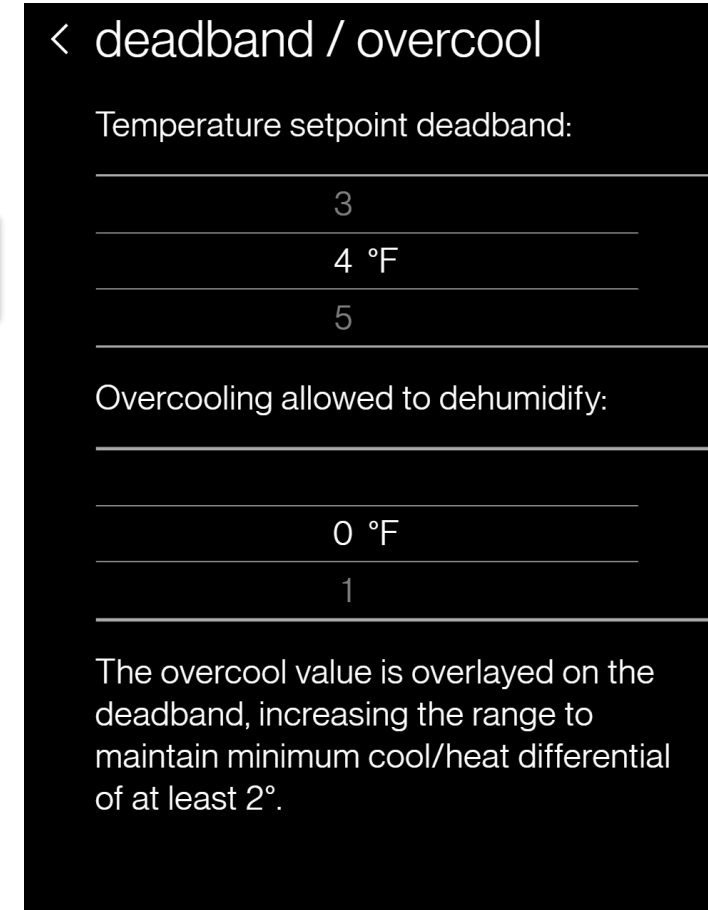
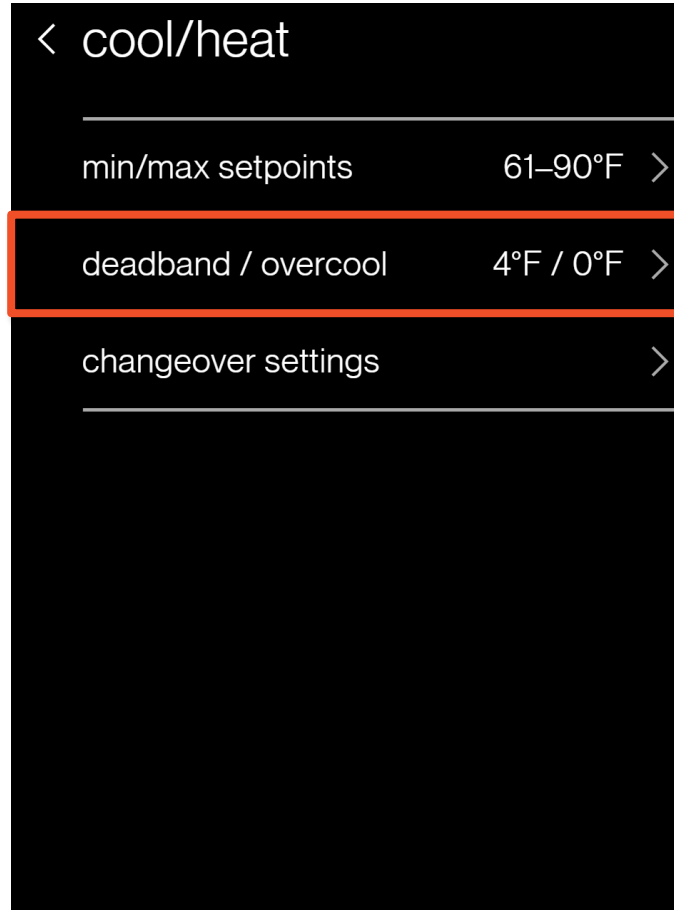



- When the indoor humidity level increase more than 3% above the humidity SP setpoint, the overcool mode is turned ON, and when it drops more than 3%, the overcool mode is turned OFF.
- When the overcool mode changes from ON to OFF, 2-hours guard timer is started
- The Thermo-ON/OFF deadband is based on field setting value ($\pm 1^\circ\text{F}$) for indoor unit.

Notes: No change with the indoor unit fan speed during overcool logic.

When overcool mode changes from ON to OFF, 2-hours guard timer is started.

Overcool Example

Thermo-ON/OFF when Overcool = 0°F

- CSP is the cooling setpoint that assigned by the user and displayed on the Daikin One+

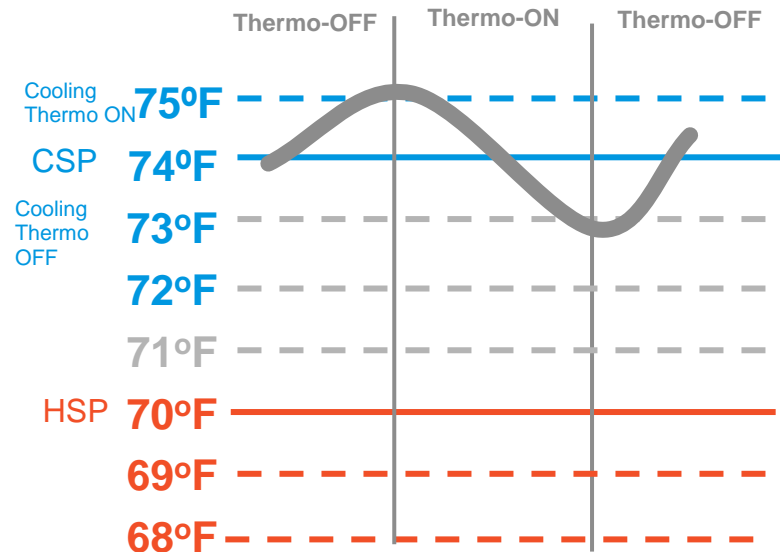

Thermo-ON/OFF when Overcool = 2°F

- Over CSP is internally calculated and is not displayed on the Daikin One+

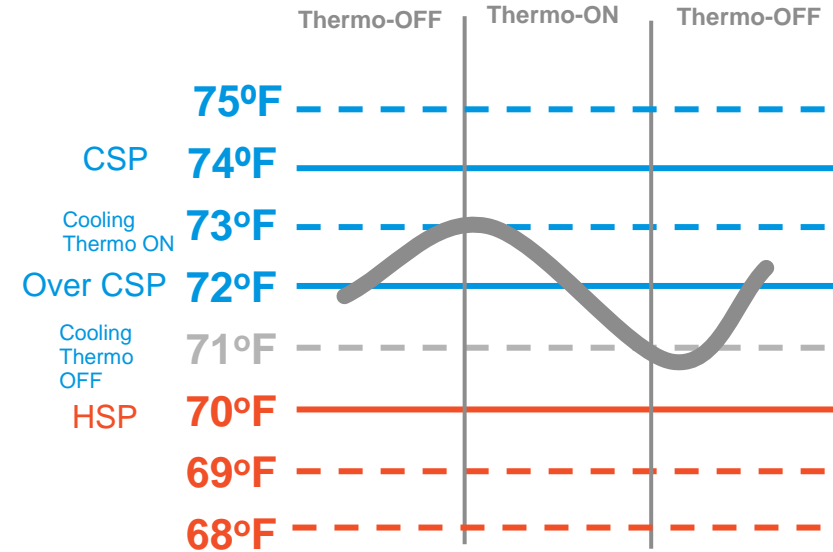

Set-up

Step 5 - Preferences

- Cool/heat:
 - Changeover settings
 - Start timer diff (1°F -4°F)
 - Forced changeover diff (1°F -4°F)
 - Changeover timer

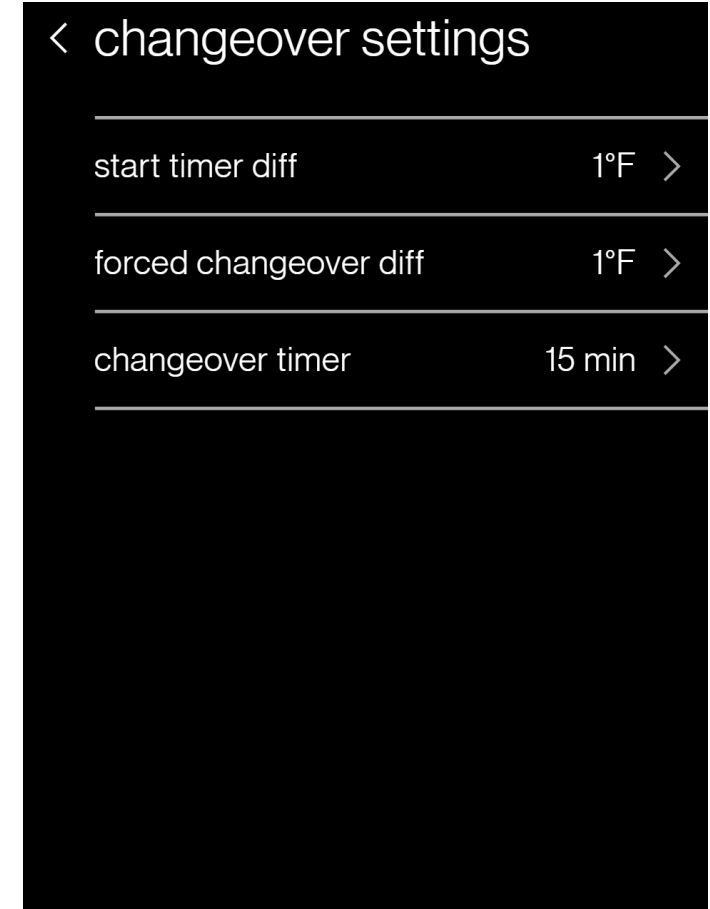
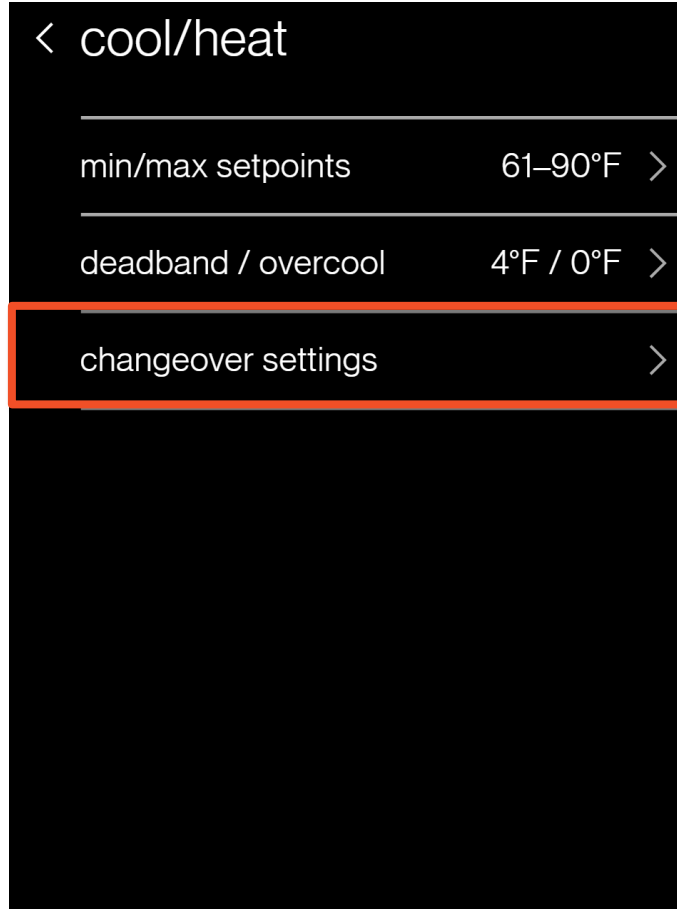

Set-up

Auto changeover

- At 1°F above cool or 1°F below heat setpoint (default)(Configurable between 1°F – 4°F.)
 - Engages changeover timer (guard timer).
 - Another 1°F above cooling or 1°F below heating changeover points (default), Forced changeover ignores changeover timer (Configurable between 1°F – 4°F.)
 - Changeover timer to prevent frequent mode change.
 - 0 (default), 15, 30, 45 or 60 minutes.
- Recommend leaving the default settings.

Same Logic As iTM and NAV.

< changeover settings	
start timer diff	1°F >
forced changeover diff	1°F >
changeover timer	15 min >

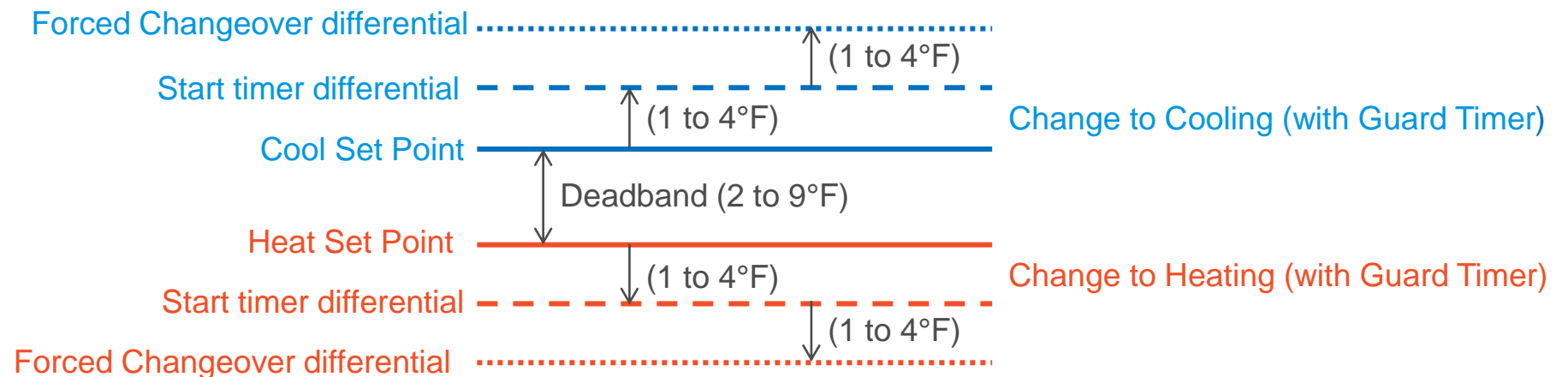

Auto-changeover

Example #1 Dual Set-points

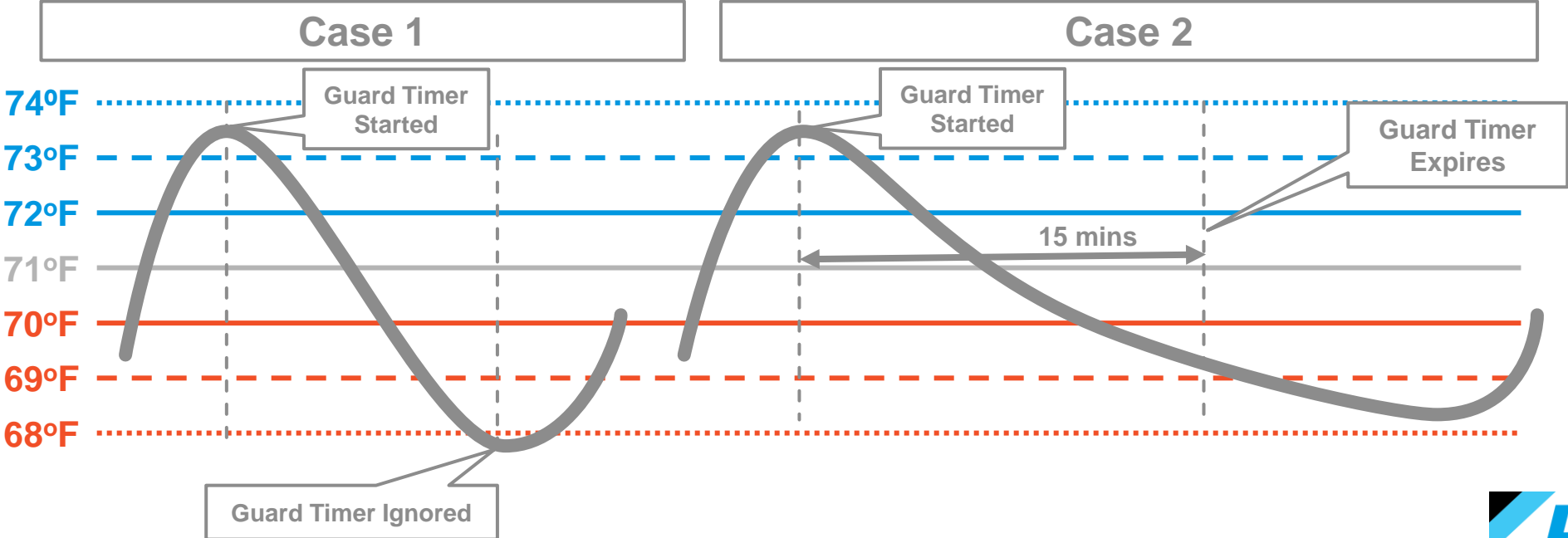
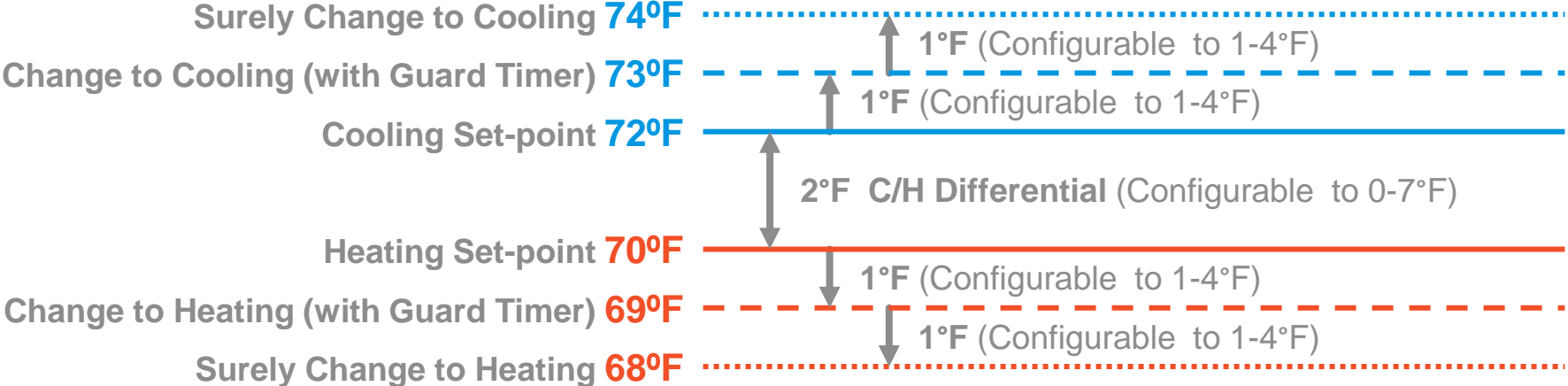

Set-up

Dealer information

- Selecting allows you to enter and review the dealer's information.
- All the information imputed can be viewed by the homeowner.

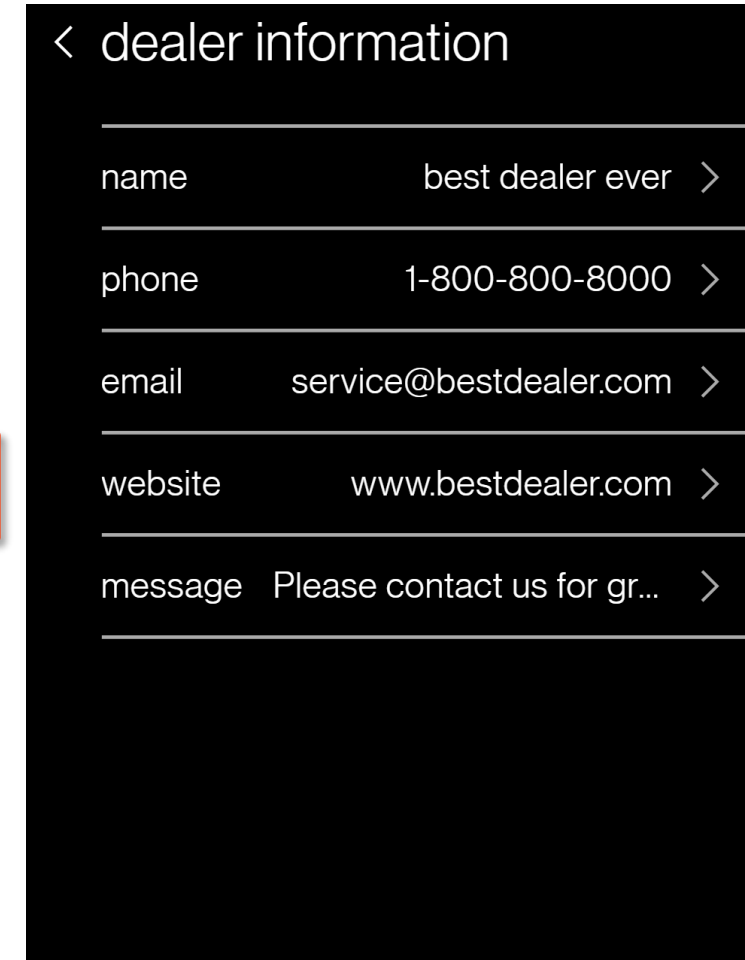
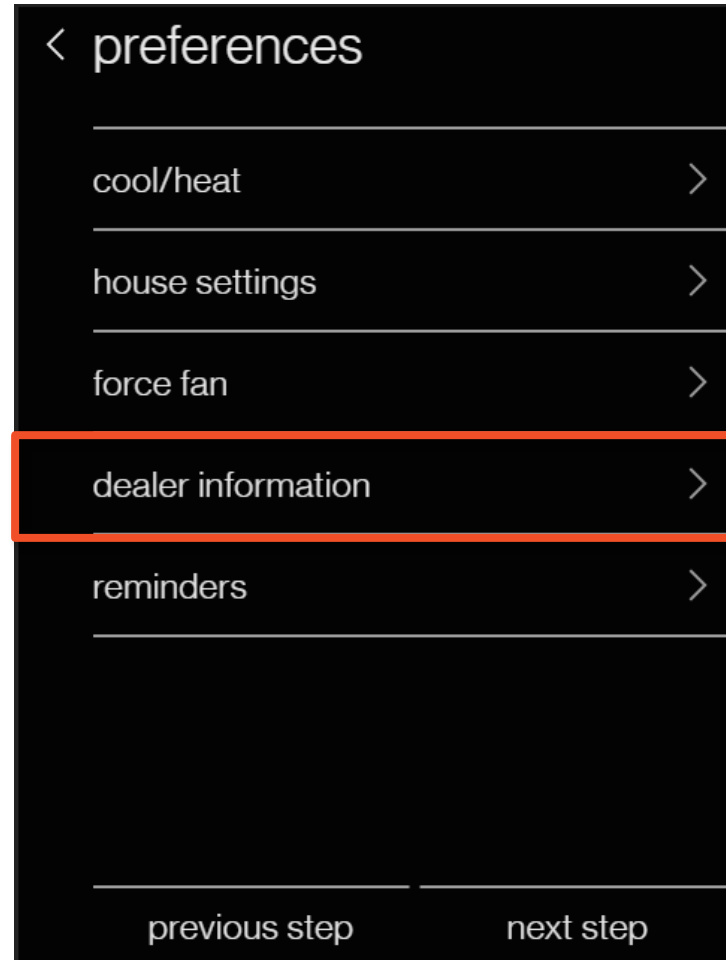

Set-up

Final step - Complete set-up

- Selecting complete set-up will conclude the full set-up of the thermostat and display normal mode for you to navigate and verify settings.
- Reminder: All steps must be reviewed before completing full set-up.

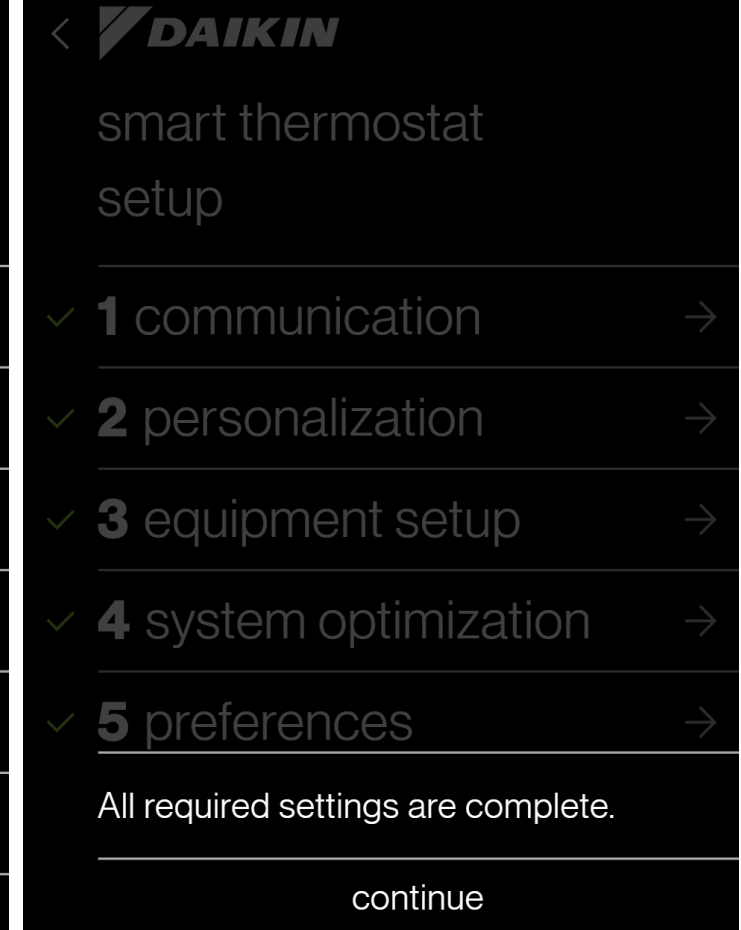
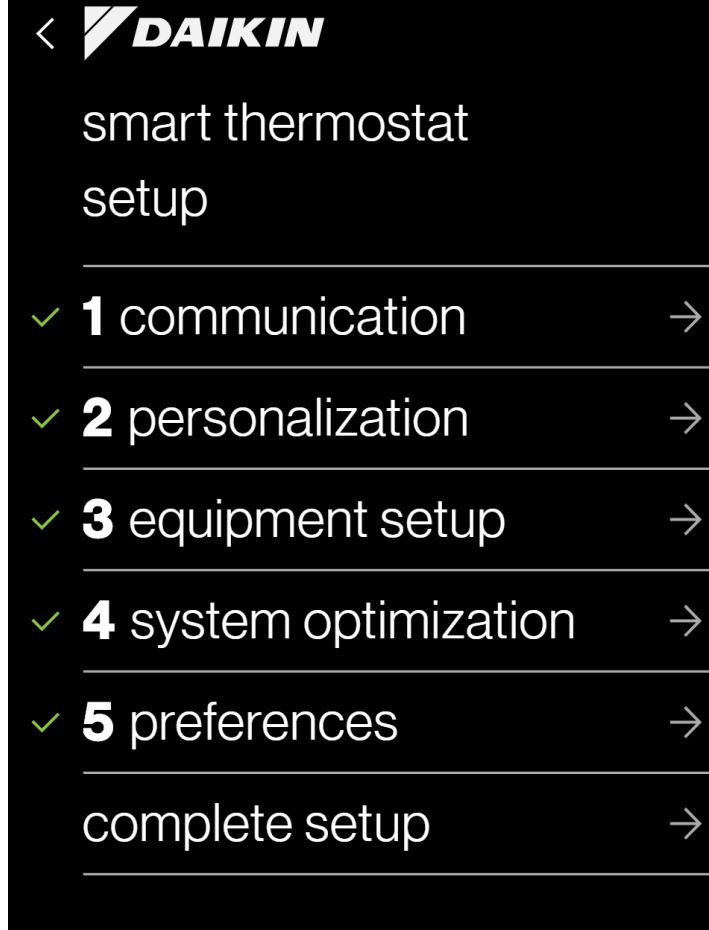

Agenda

Daikin One+

System Configurations

Installing Daikin One+

Commissioning Daikin One+

Dealer Navigation

Homeowner Navigation

Dealer Navigation

Dealer edit

- Navigating to dealer edit will allow you to access or revisit the installer set-up screen.
- Advanced adjustments to the Daikin One+ will be made here.

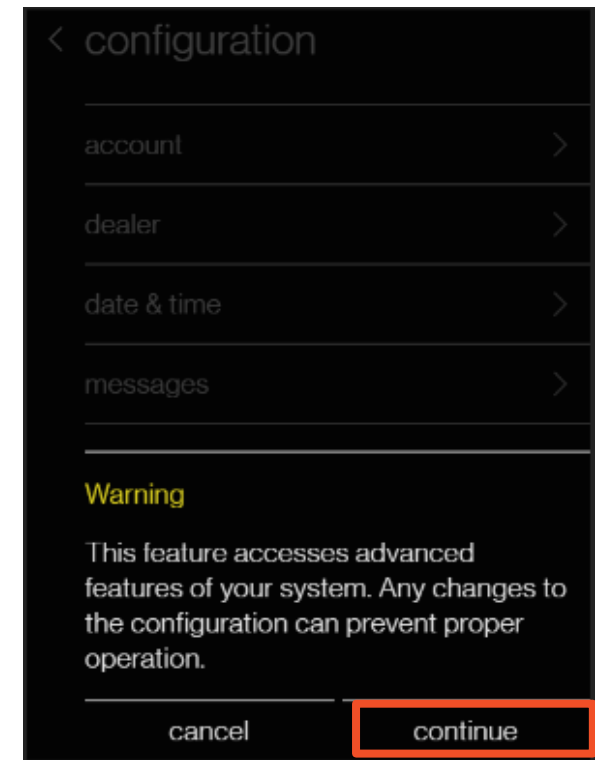
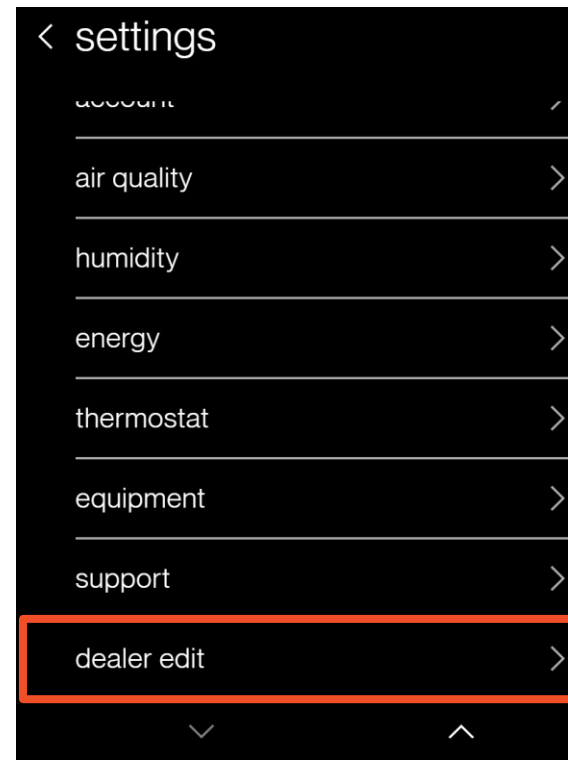
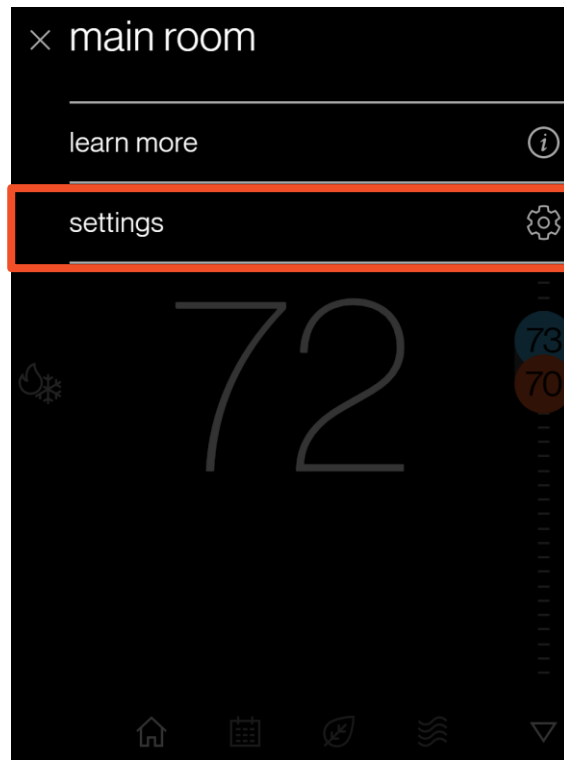
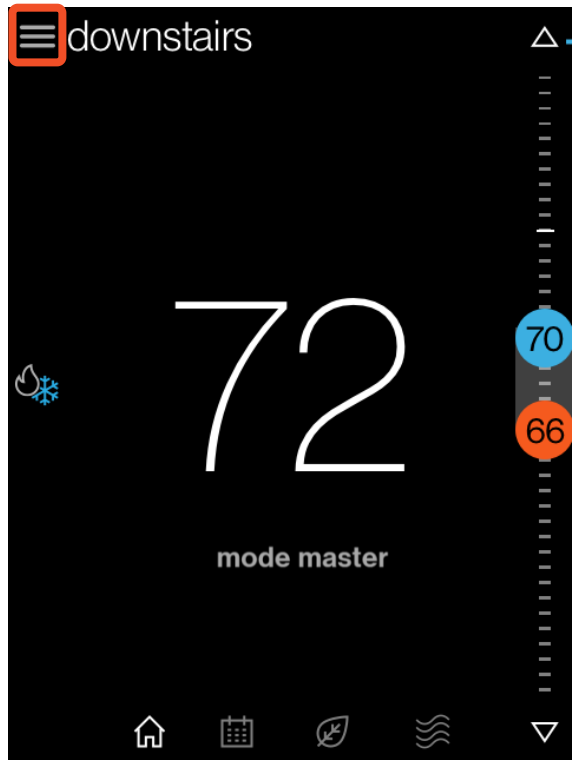

Dealer Navigation

- Acknowledging the prompt enables you to tap the learn more icon.
- The icon displays the installer code, giving you access to the installer set-up screens.

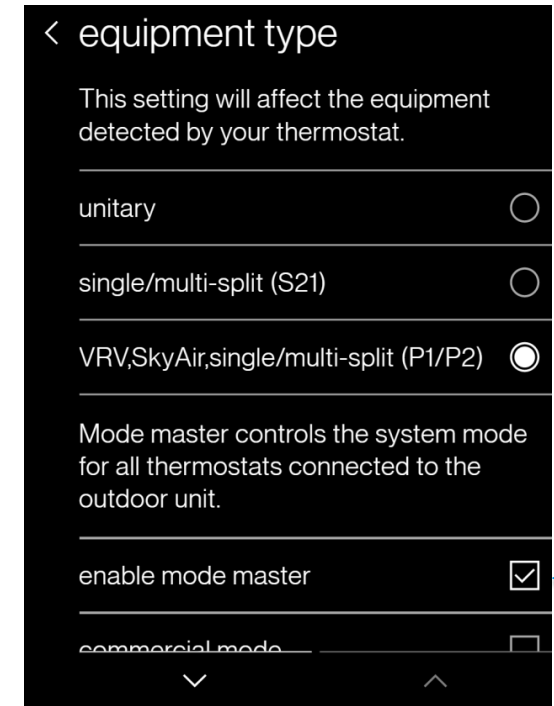
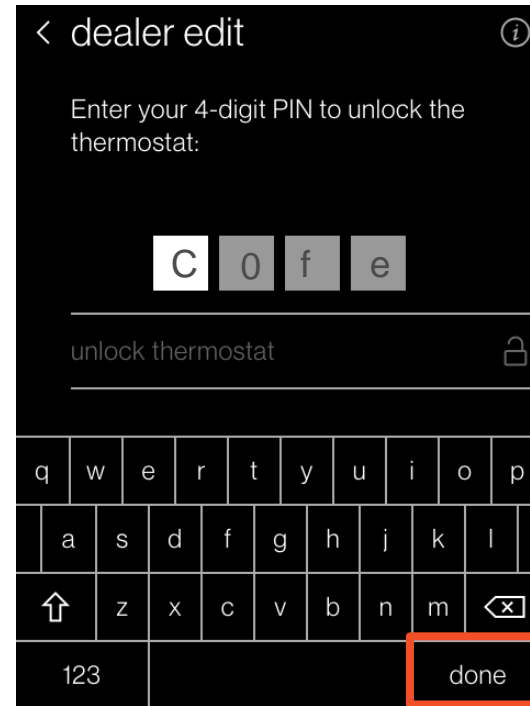
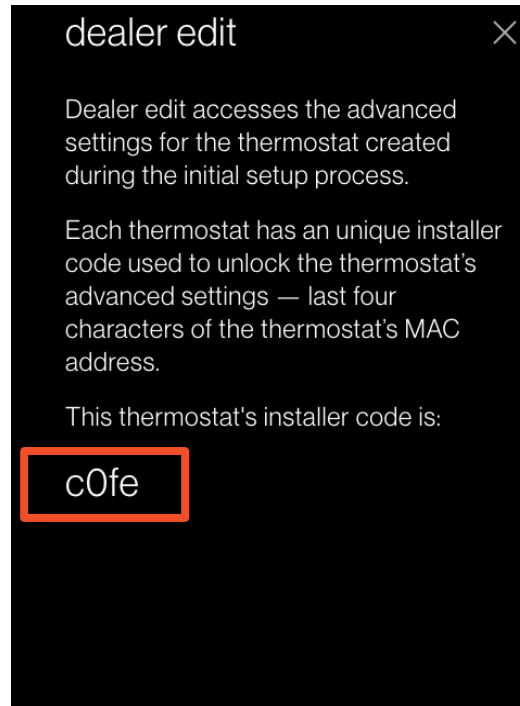
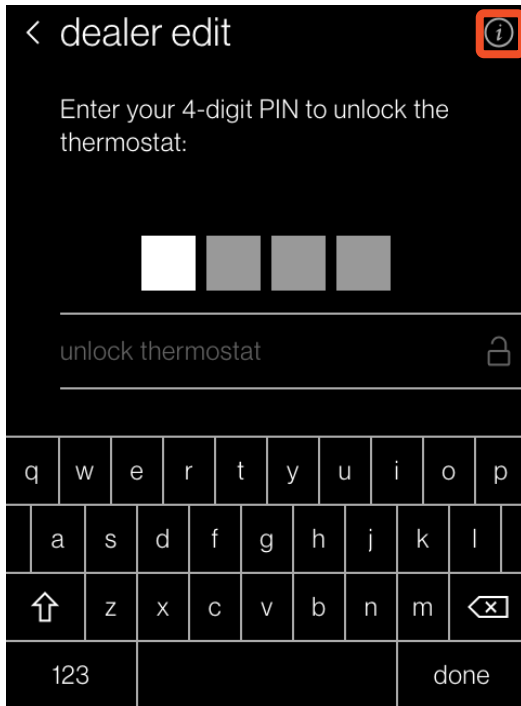

Note: Releasing the changeover master by uncheck “enable mode master”

Dealer Navigation

Releasing the mode master

- Uncheck the tick mark

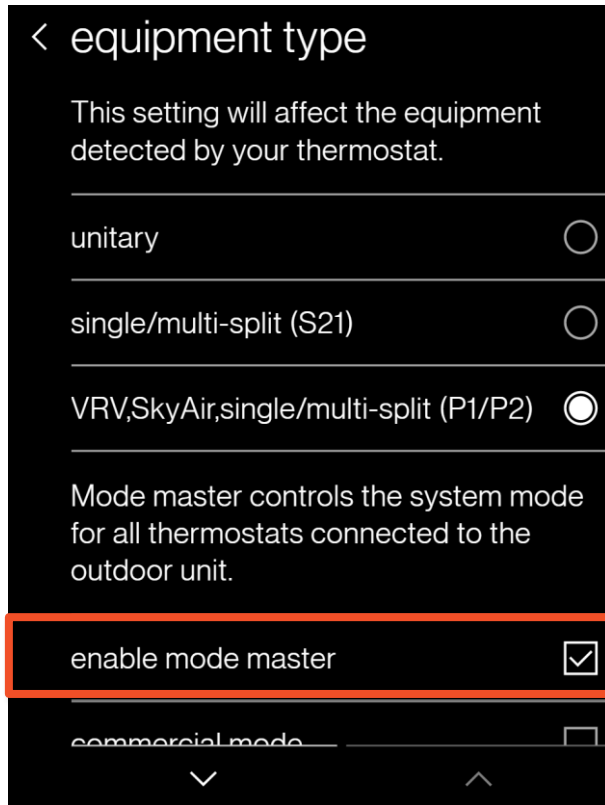

- The ONE+ will keep requesting to set the changeover mode master indoor unit.

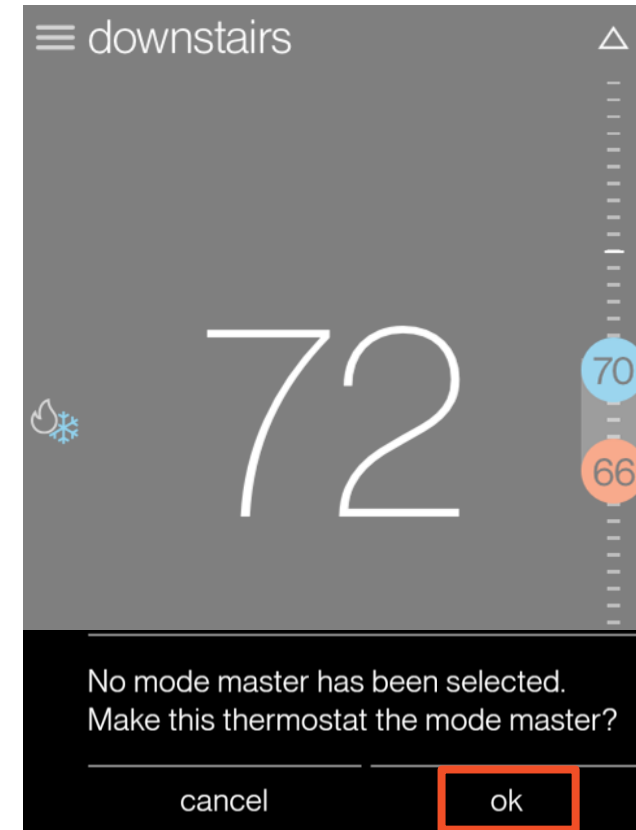

This message will keep showing up until the master is selected.

Other Screens

External Stop - T1T2

- The following message will display when T1T2 contact of the indoor unit close.

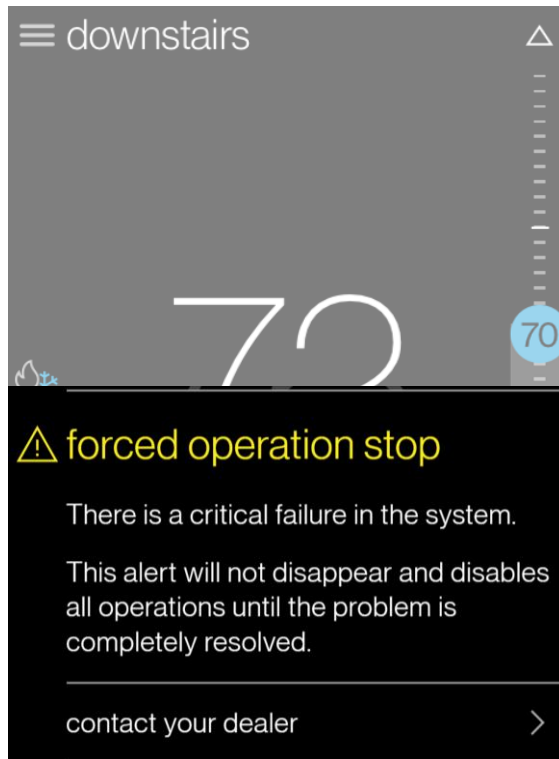

Test operation

- When Test operation is performed from the ODU, this screen will display

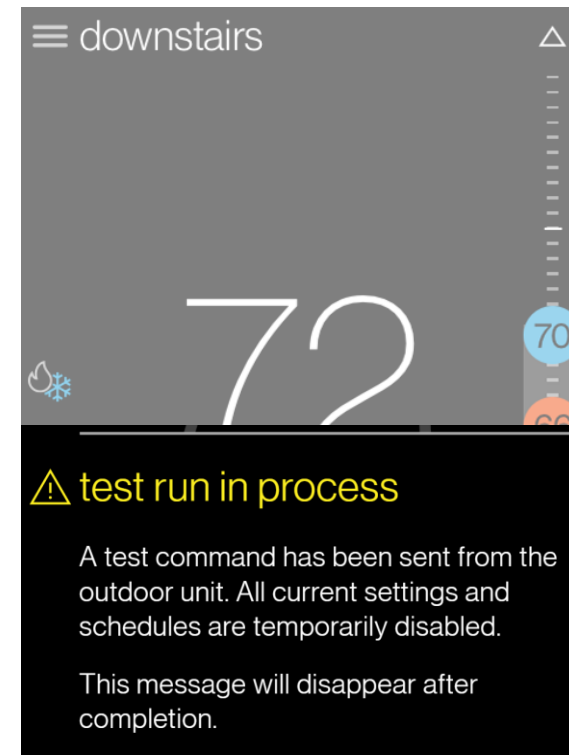

Agenda

Daikin One+

System Configurations

Installing Daikin One+

Commissioning Daikin One+

Dealer Navigation

Homeowner Navigation

Homeowner Navigation

Normal Mode

- Normal mode allows you to view messaging, temperature, and access settings to adjust parameters placed by the installer.
- Navigating is accomplished by tapping icons or turning the analog dial.
- Note: Analog turn dial is used to adjust temperature only. Pressing the dial returns to the home screen.



Homeowner Navigation

Adjust control

- Tapping the system mode icon allows you to select:
 - Auto. (cool & heat)
 - Cool.
 - Heat.
 - Off.
- Change setpoints by rotating the dial, touching and holding the setpoint to drag the desired temperature setpoint, or use the up and down setpoint arrows

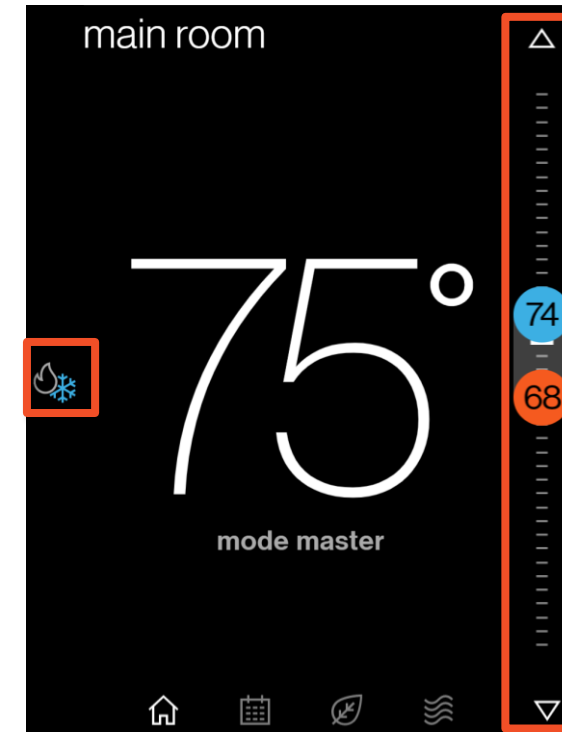

Homeowner Navigation

Schedule

- The schedule is presented as 7 days, displaying one day at a time, with 24 hours fitting on the screen.
- You can use the drop-down menu to enable schedule editing.
- Copy and paste is a feature that makes scheduling seamless.
- Note: Scheduling requires saving edits before exiting the mode.

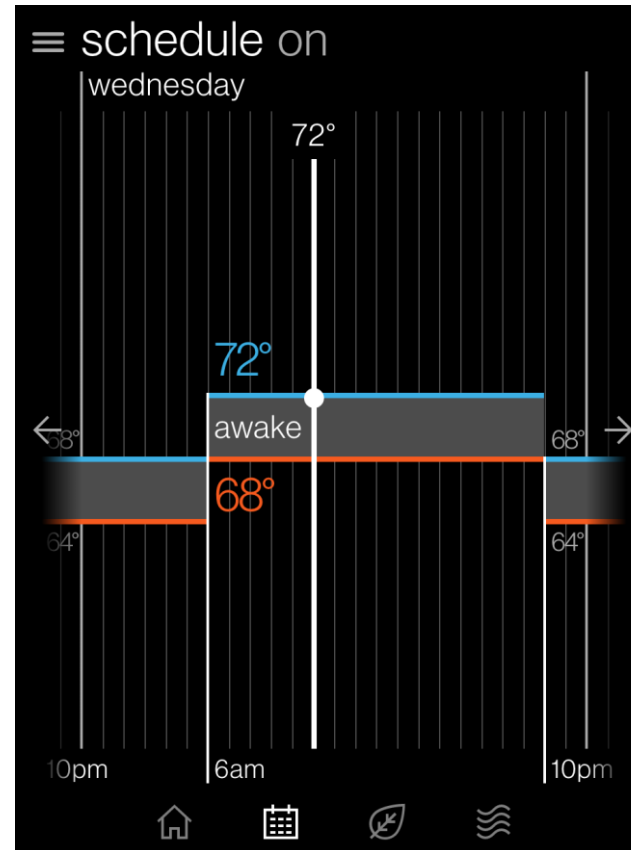

tuesday

awake
6:00 am 68°/72°

sleep
10:00 pm 64°/68°

copy day

to:

s m t w t f s

cancel paste

Homeowner Navigation

Away

- The away screen displays the current state (on/off) and the away cooling/heating setpoints used when away is on.
 - on/off is selected from drop down menu.
- User can change the values of the setpoints by dragging the numbers or the comfort range up and down.
- With the mobile app., enabling geofencing will automatically switch to energy savings when outside the radius.

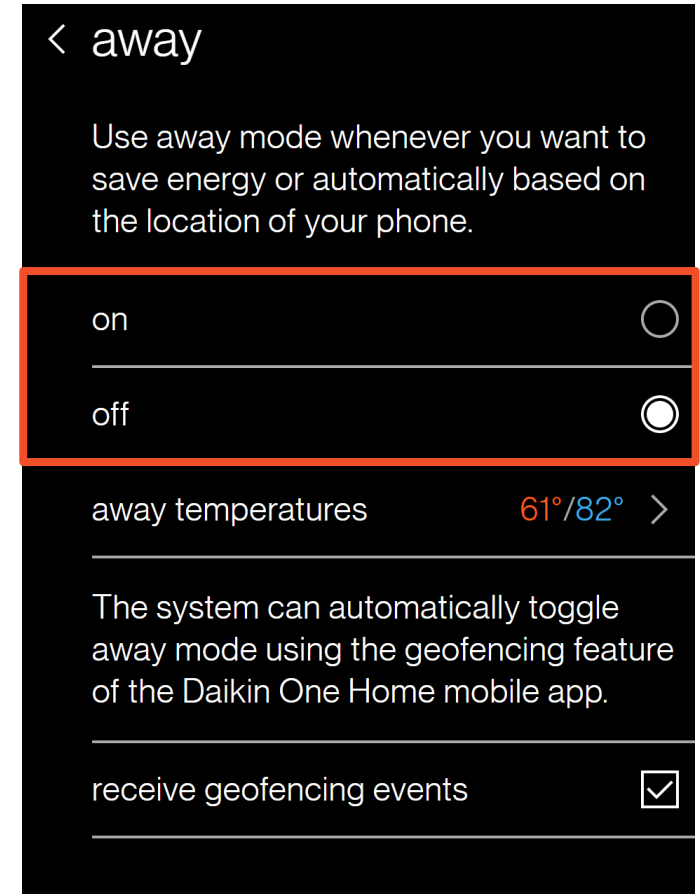
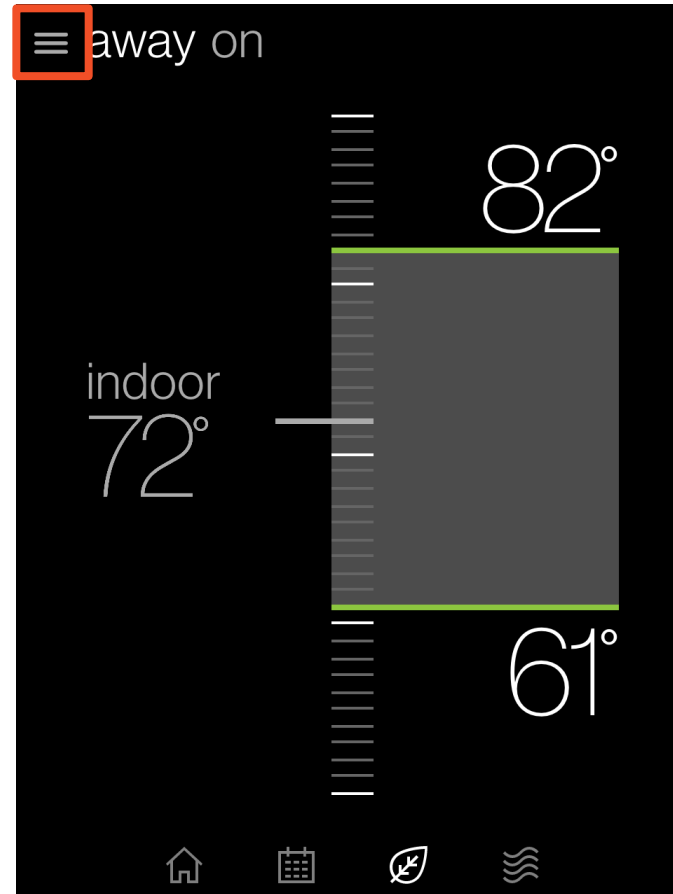



Air quality

- The air quality screen displays indoor air quality levels and the outdoor air quality, temp and humidity (**when the ONE+ is connected to the internet [weather Service] and paired with the app.**)
- Indoor air quality is based on filter life cycle and humidity values.
- Fan settings
 - Adjust fan speed
 - Adjust louver position
 - Enable/disable draft protection.

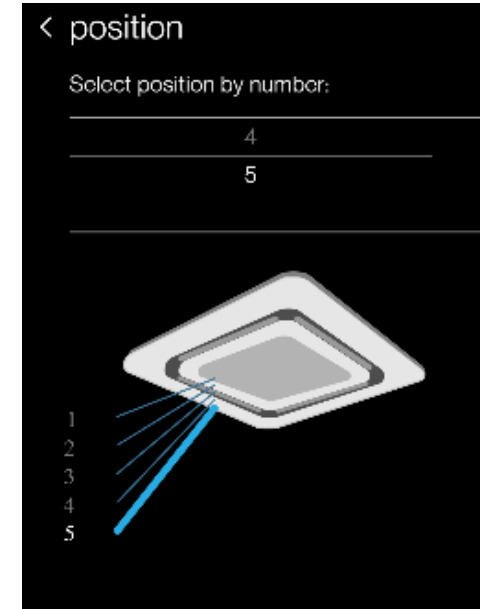
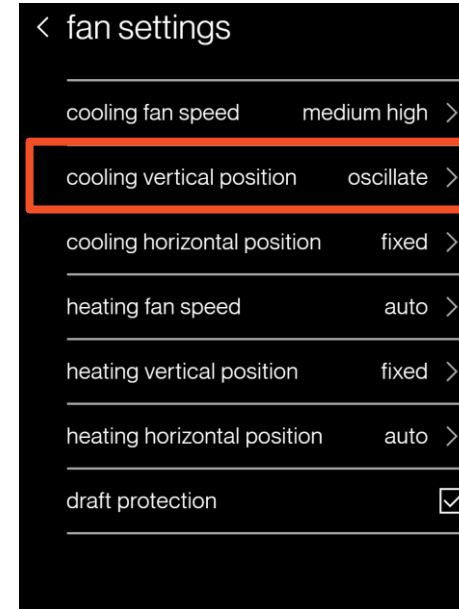
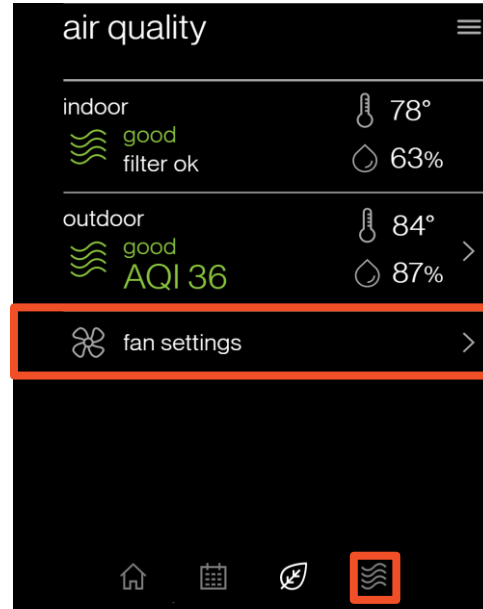

Note: The availability of the fan speed and louver control are based on the selected indoor unit model

Homeowner Navigation

Settings

- Settings gives you access to additional supporting features:
 - Display.
 - Adjust and enable visual features.
 - Comfort.
 - Set target humidity.
 - Configuration.
 - App. account setup
 - Dealer information
 - Date & Time
 - Enable messages/view alerts
 - System components
 - Home Wi-Fi

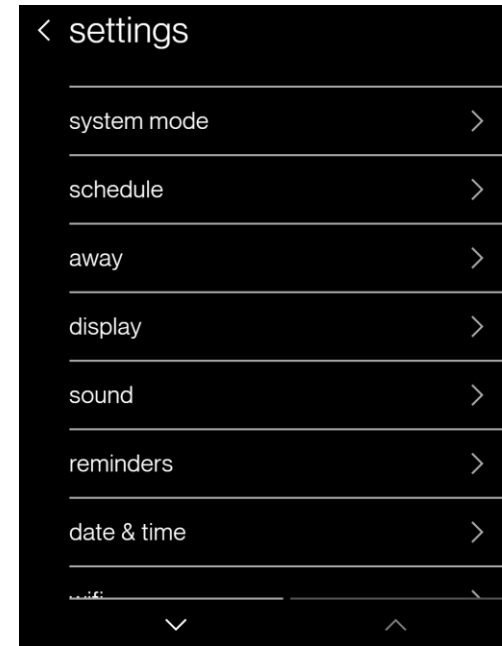
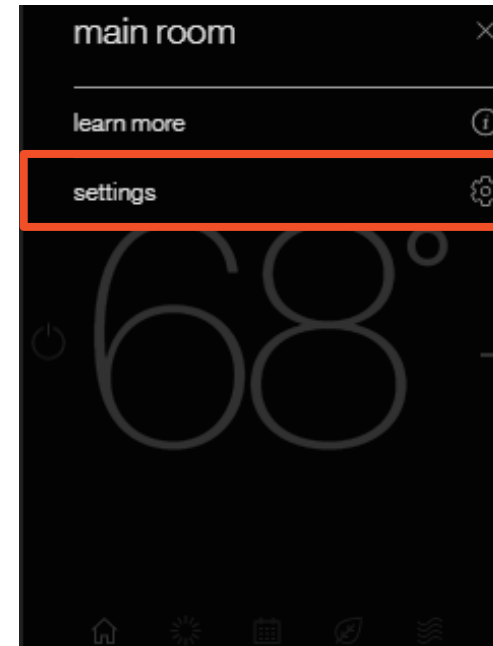
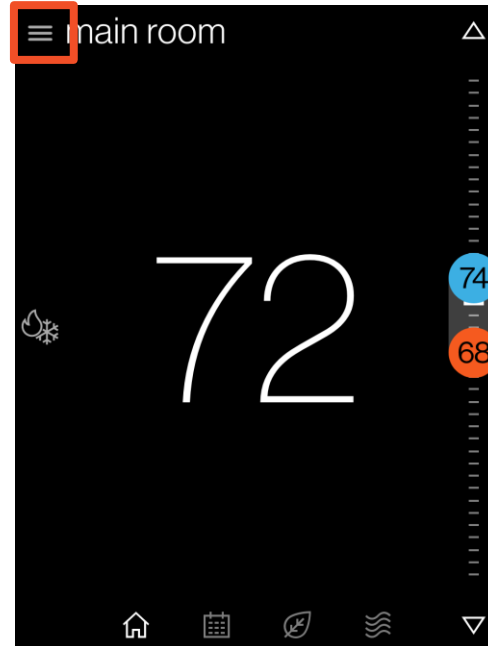

Daikin One+

Messaging

- The homeowner/user can temporarily dismiss the message or restart the system; however, some alerts may remain until the issue is resolved by a dealer.

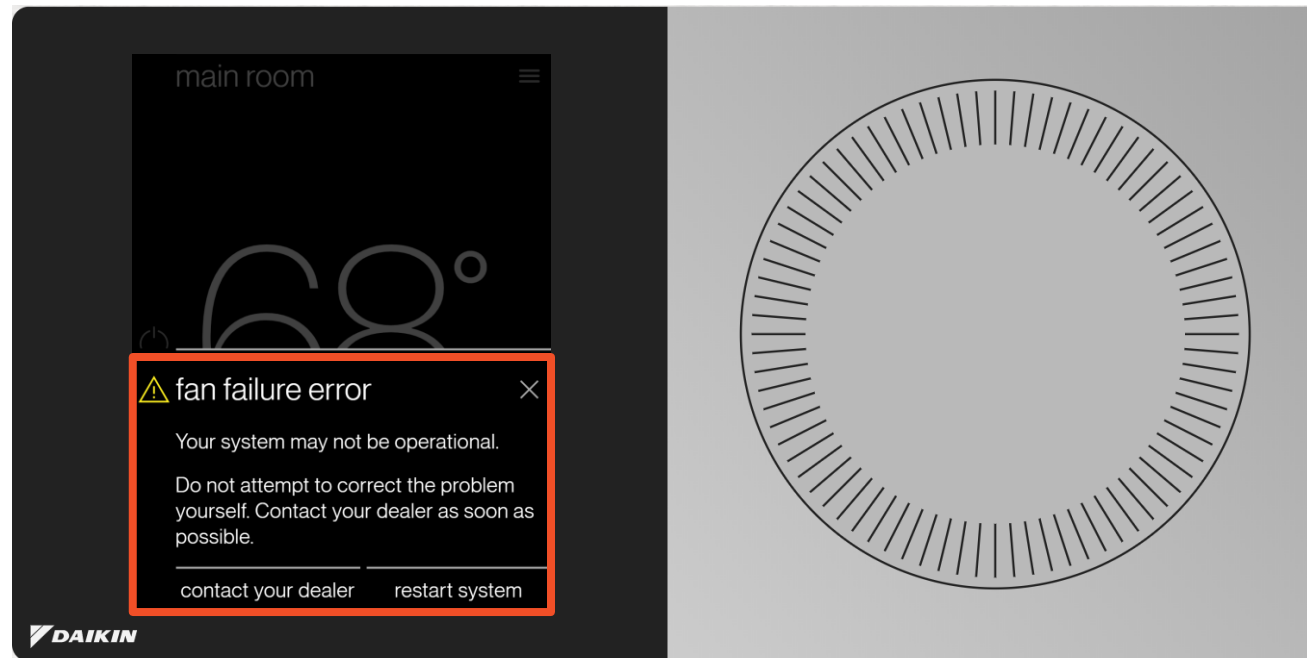

Note: Daikin error code will not show up on the home screen, however it will show up on the error history menu

Daikin One+

Smart Messaging

- Daikin One's messaging updates, confirms, and informs about selections you make during set-up and operation.
- There are four types of messages:
 - Status
 - Alerts
 - Reminders and Prompts
 - Learn more/tips

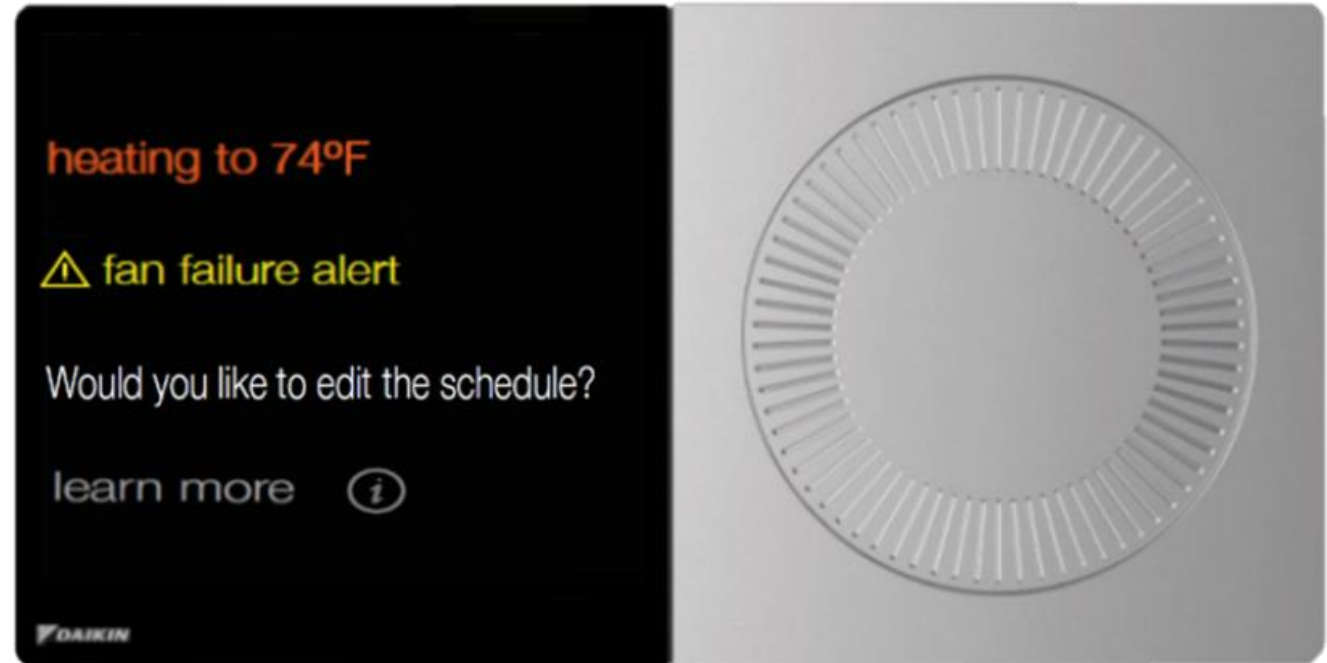

Note: Alerts have priority over all other messages in the system.



DAIKIN

AIR INTELLIGENCE



Assessment

Assessment

1. How many fan coils can the Daikin One+ connect to on P1P2?

- a) One
- b) Five
- c) Ten
- d) Sixteen

2. Is the Daikin One+ able to be daisy chained on the P1P2 bus with other local controllers on an existing job?

- a) Yes
- b) No

3. What is needed to connect the Daikin One+ to P1P2?

- a) Just wire directly to P1P2
- b) Translation adaptor
- c) Transformer

Assessment

4. What is the max distance of wiring between the Daikin One + and the Translator?

- a) 20 ft
- b) 50 ft
- c) 100 ft
- d) 125 ft









5. The Daikin One+ should not be installed near which of the following?

- a) Drafts of dead spots
- b) Hot or cold air from diffusers or fans
- c) Radiant heat from sun or appliances
- d) All the above

6. How many steps are there in the set-up process?





- a) 2
- b) 4
- c) 5
- d) 8

Assessment





7. Which equipment type must you select for FFQ indoor Unit?
- a) Unitary. 
 - b) Single zone/Multi zone (P1/P2). 
 - c) Equipment type selection is not required. 
 - d) VRV/SkyAir 
8. Never use screws when mounting the translation adaptor to an indoor unit.
- a) True 
 - b) False 
9. If power wires are reversed the PWR LED will flash green.
- a) True 
 - b) False 

Assessment





10. When commissioning the Daikin One+ through full setup, what steps need to be reviewed before completing the setup?

- a) All steps. 
- b) Communication and system optimization. 
- c) Personalization, communication, and preferences. 
- d) Equipment setup and communication. 

11. The Thermo-ON/OFF deadband is a fixed value of ___ for mini and multi split indoor unit.





- a) $\pm 4^{\circ}\text{F}$ 
- b) $\pm 2^{\circ}\text{F}$ 
- c) $\pm 9^{\circ}\text{F}$ 
- d) $\pm 1^{\circ}\text{F}$ 

12. Measurement between data line 1 and 2 should read



- a) 0.06VDC 
- b) 24VAC 
- c) 0.6VAC 
- d) 0.6VDC 

Assessment





13. How high on an interior wall should the Daikin One+ be mounted?

- a) 3' 
- b) 4' 
- c) 5' 
- d) 6' 

14. Do not install the Daikin One+ where it can be affected by radiant heat from the sun or appliances.

- a) True 
- b) False 

15. Error history logs alerts that are color coded, ___ being non-critical and ___ being critical.

- a) Green, Yellow 
- b) Blue, White 
- c) White, Yellow 
- d) Yellow, Red 

Assessment

16. What is needed to create a mobile account?

- a) The Daikin One+, a Tablet, and a valid email address. ●
- b) A mobile device, the Daikin One+ connected to Wi-Fi that is wired to an S21 or P1P2 system and a valid email address. ●
- c) An indoor unit, an outdoor unit and the Daikin One+. ●
- d) A mobile device connected to connected to Wi-Fi, an indoor unit and an outdoor unit. ●

17. The ONE+ can display the outdoor Air temperature through:

- a) The outdoor unit temp sensor. ●
- b) Wireless outdoor air sensor ●
- c) Weather Services ●
- d) Any of the Above. ●



DAIKIN

AIR INTELLIGENCE