

Daikin One Touch Thermostat

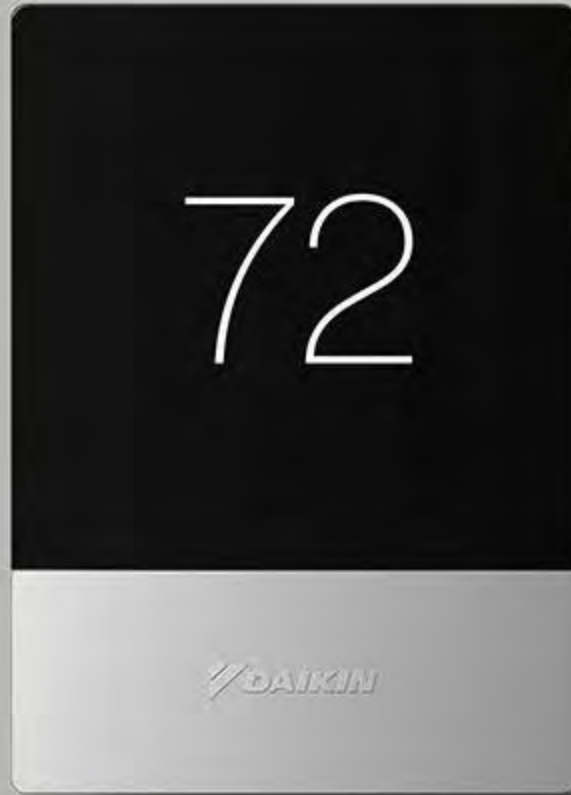

Training Module TRC-10



Disclaimer

This material provides technical information that is to only be used by appropriately trained and certified HVAC-R installers and technicians who have agreed to the terms and conditions available here at <https://www.daikincity.com/DaikinCityB2BTermsOfUse.html>. If you have not agreed to these terms and conditions, you may not use or view this material, and you assume responsibility for any injury or property, system or equipment damage which may result. If you have agreed to these terms, you also agree, by viewing or using this material, that this material, by its nature, cannot include a discussion of everything necessary to effect a proper installation or repair of HVAC-R equipment, nor can it address every possible scenario or environment a technician or installer may encounter. Accordingly, this material should not be considered as recommendations for best practices and will not be considered installation or repair instructions to the extent of any conflict with Daikin- or Goodman-issued manuals and specifications, or industry standards and regulations. Each installer or technician remains fully responsible for ensuring proper installation or repair of the HVAC-R equipment being worked on, and you remain fully responsible for any injury or property, system or equipment damage which may result from your installation.

©2021 Daikin, all rights reserved.

Agenda

Daikin One Touch

System Configurations

Installing Daikin One Touch

Commissioning Daikin One Touch

Full Set-up

Dealer Navigation

Homeowner Navigation

Mobile Apps

Daikin One Touch

- Premium control that provides optimal comfort.
- The high-resolution touch screen supports tactile-based interactions.
- Navigating to each screen is done by tapping an icon.
- Designed to regulate and communicate with HVAC equipment.
- The user will be able to control the indoor unit remotely through the Daikin One Home app.

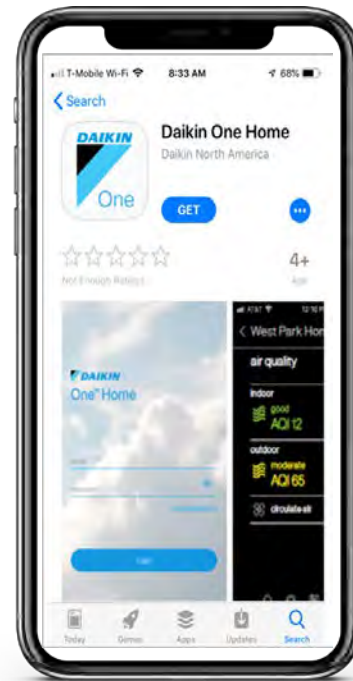
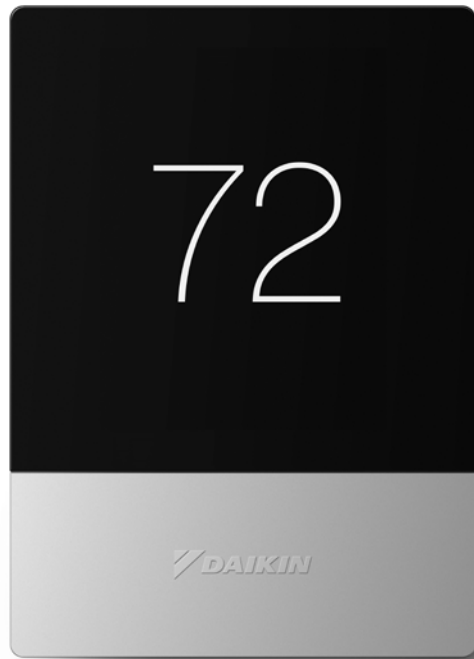

Service reminders

- Set service reminders to maintain your system.
- Preset reminder options include:
 - Media filter
 - Humidifier Pad
 - Service reminders

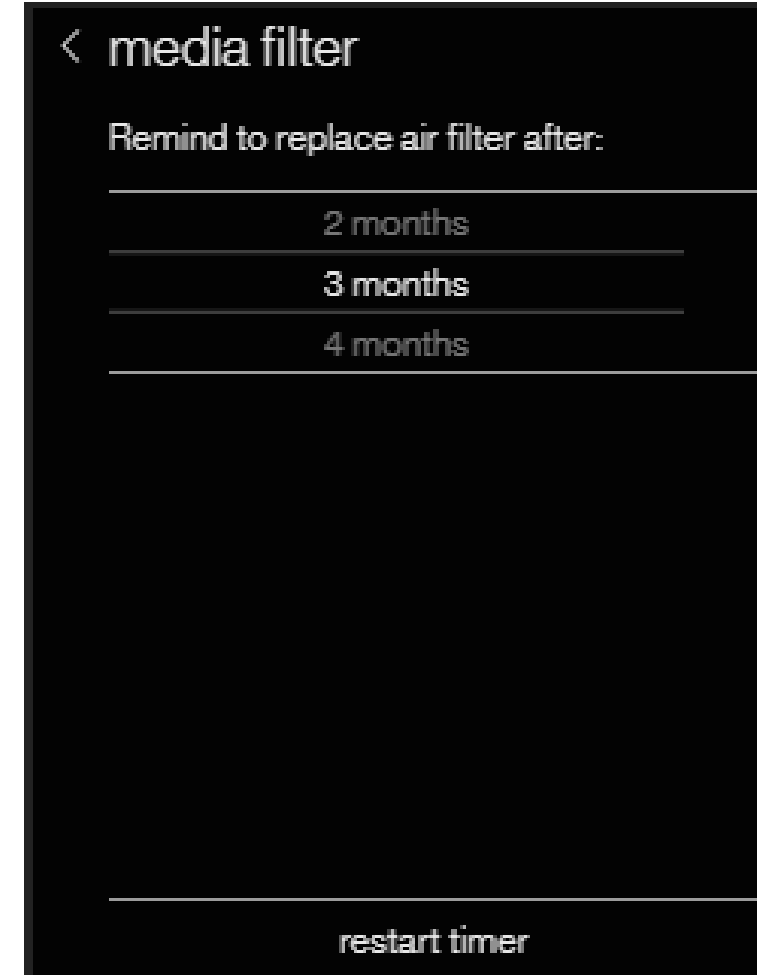
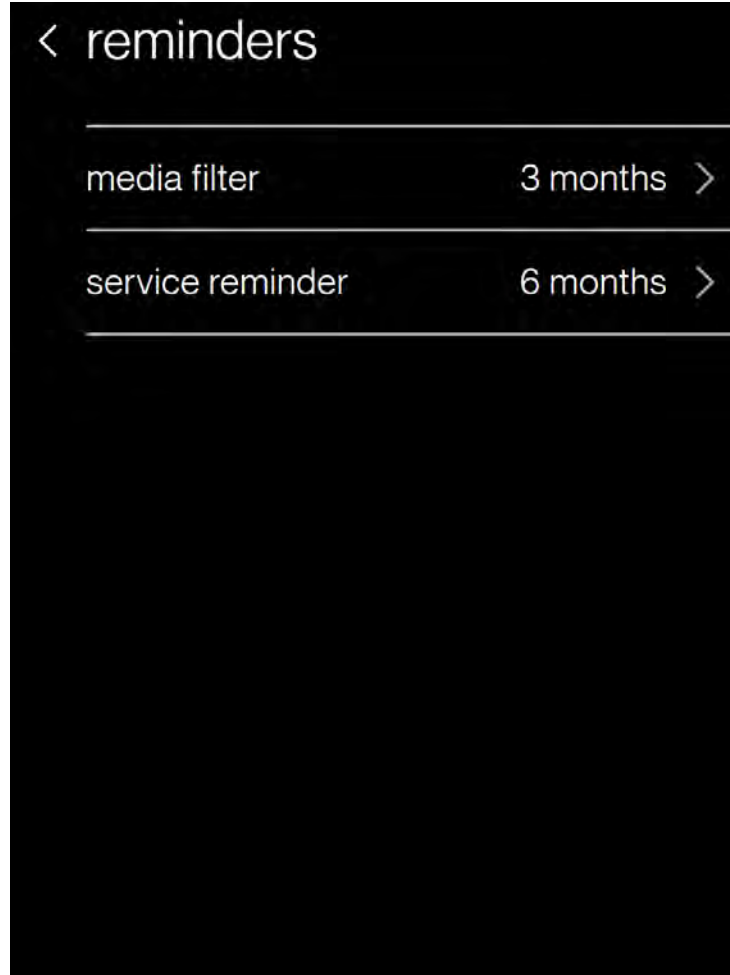

Daikin One Touch - Messaging

- Daikin One Touch messaging updates, confirms, and informs about selections you make during set-up and operation.
- There are four types of messages:
 - Status
 - Alerts
 - Reminders and Prompts
 - Learn more/tips

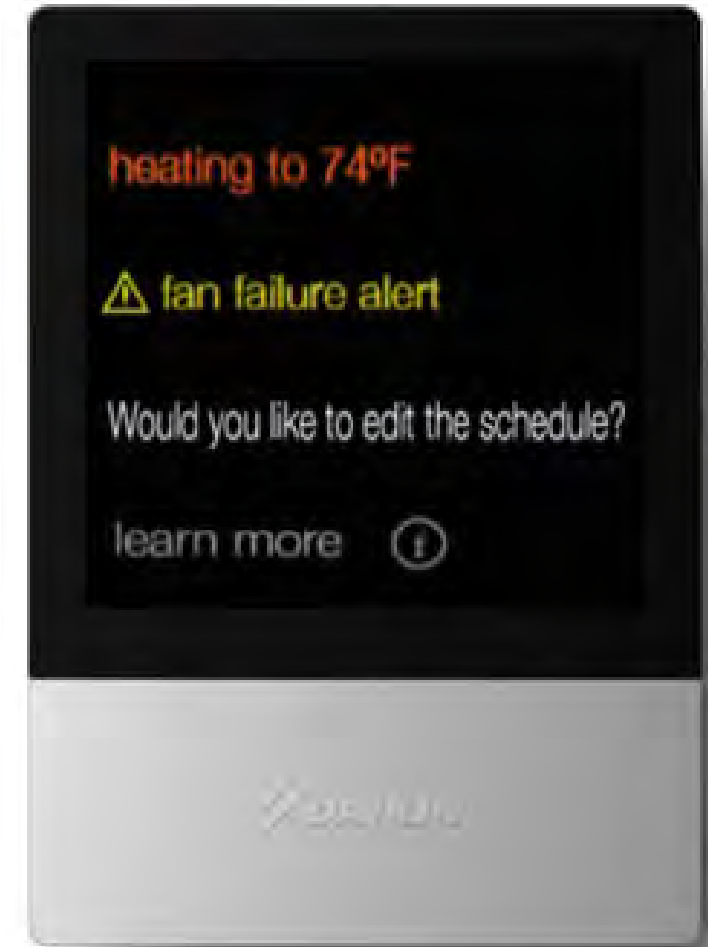

Note: Alerts have priority over all other messages in the system.

Daikin One Touch - Quick Reference Card

- Quick reference cards are packaged with the thermostat to help answer questions during the installation and commissioning.

Dealers

Install the thermostat

Use the two included screws to secure the terminal plate to the wall. After connecting the wires, hook the top edge of the thermostat onto the holes on the top edge of the terminal plate. Rotate the thermostat down until it snaps into place. Once connected to power, follow the on-screen instructions.

Begin Setup
Use begin setup to customize settings and ensure the system is properly configured and ready for homeowners to use.



Terminal plate Screws Thermostat

Attach the thermostat to the terminal plate and snap into place



Get help at dealer daikinone.com/resources

Homeowners

Install the mobile app

Monitor and control your HVAC system from across the room, or from across the country.



Available on the App Store and Google Play.



daikinone.com/app

Learn more about your smart thermostat

Find additional information about how your smart thermostat works and download the Homeowner Guide.



daikinone.com/onetouch

Scanning the bar code on the **bottom left** corner will link you to a website related to the title of the card.

<https://daikinone.com/professionals/resources>

Agenda

Daikin One Touch

System Configurations

Installing Daikin One Touch

Commissioning Daikin One Touch

Full Set-up

Dealer Navigation

Homeowner Navigation

Mobile Apps

Valid System Configurations

Communicating Indoor

- Air handler.
- Furnace.
- EEV coil.

Communicating Outdoor

- Heat pump.
- Air Conditioning.

Non-communicating Indoor

- Furnace
 - Utilizing a D24V Gateway

Non-communicating Outdoor*

- 24V single-stage condenser.



*Added equipment.

Agenda

Daikin One Touch

System Configurations

Installing Daikin One Touch

Commissioning Daikin One Touch

Full Set-up

Dealer Navigation

Homeowner Navigation

Mobile Apps

Installing Daikin One Touch

DO NOT Install the thermostat where it can be affected by:

- Drafts or dead spots behind doors and in corners.
- Hot or cold air from ducts or ceiling fans.
- Radiant heat from the sun or appliances.
- Concealed pipes and chimneys.
- Unheated (uncooled) areas such as an outside wall.



Installing Daikin One Touch

- Mount the thermostat to be
 - Leveled.
 - Approximately 5' from the floor.
 - On an interior wall using the included screws.
- Attach the thermostat to the top of terminal plate and snap into place

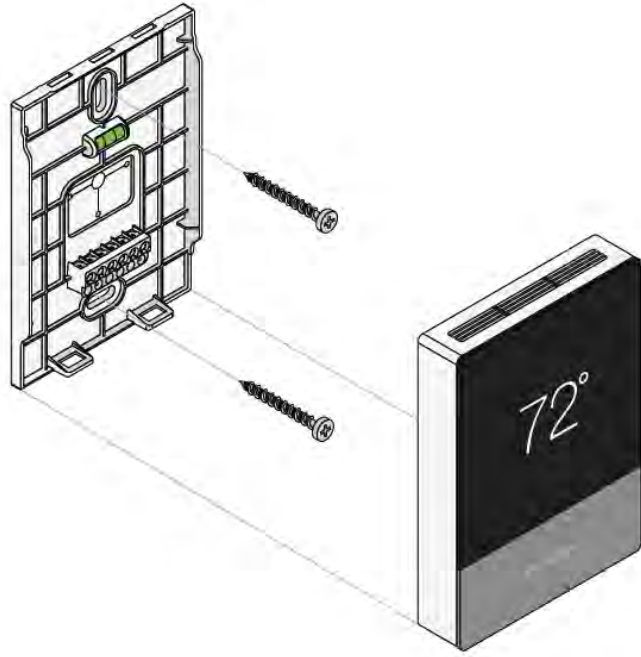

Installing Daikin One Touch

Wiring thermostat to communicating systems

- Maximum wire distance between the Daikin One Touch and the indoor unit should not exceed **125 feet using 18-gauge wire.**
- **Check for proper voltage before and after wiring is installed.**
 - 0.6VDC between Data 1 and 2
- Wiring communicating indoor unit to communicating outdoor units.
 - Connect **1, 2, C and R** from the **Daikin One Touch**, to **1, 2, C and R** at the **indoor** unit.
 - Connect wires **1 and 2** from the **indoor** unit to **1 and 2** at the **outdoor** unit.
- **Note:** The Daikin One Touch is labeled **1, 2, C, R**. **If wired incorrectly, you will receive a communication error, or your equipment may not be recognized and displayed.**

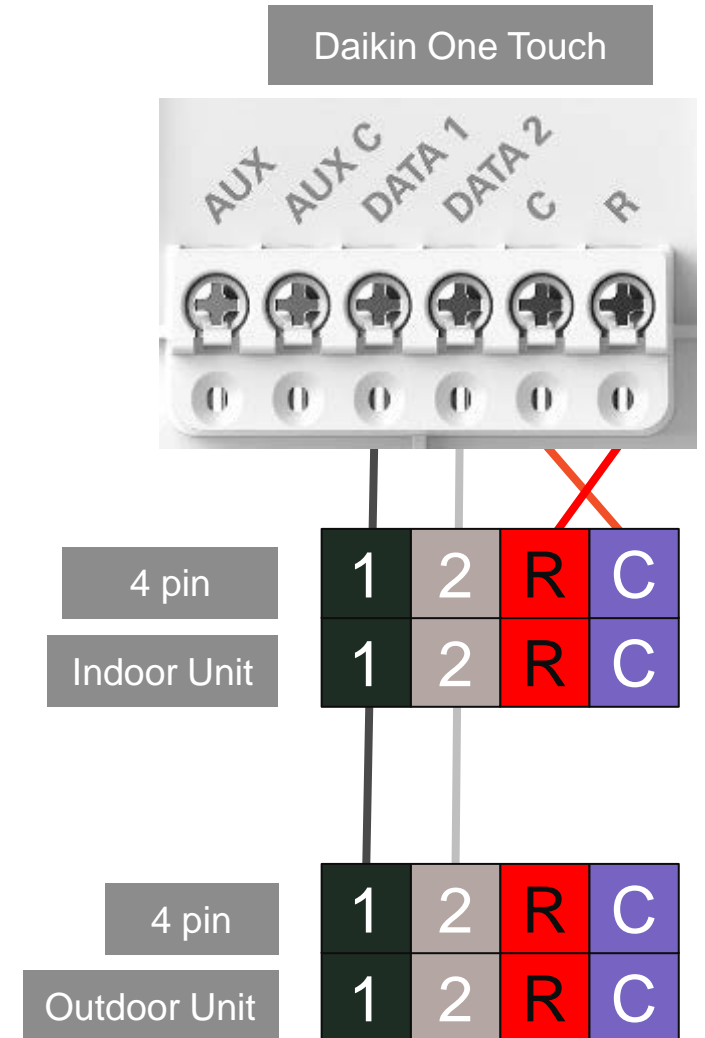

Aux Wiring

- The thermostats Aux outputs are dry contacts that close the connection to turn on the Aux equipment.
- A 24V AC control signal must be routed through one of the aux contacts of the thermostat.

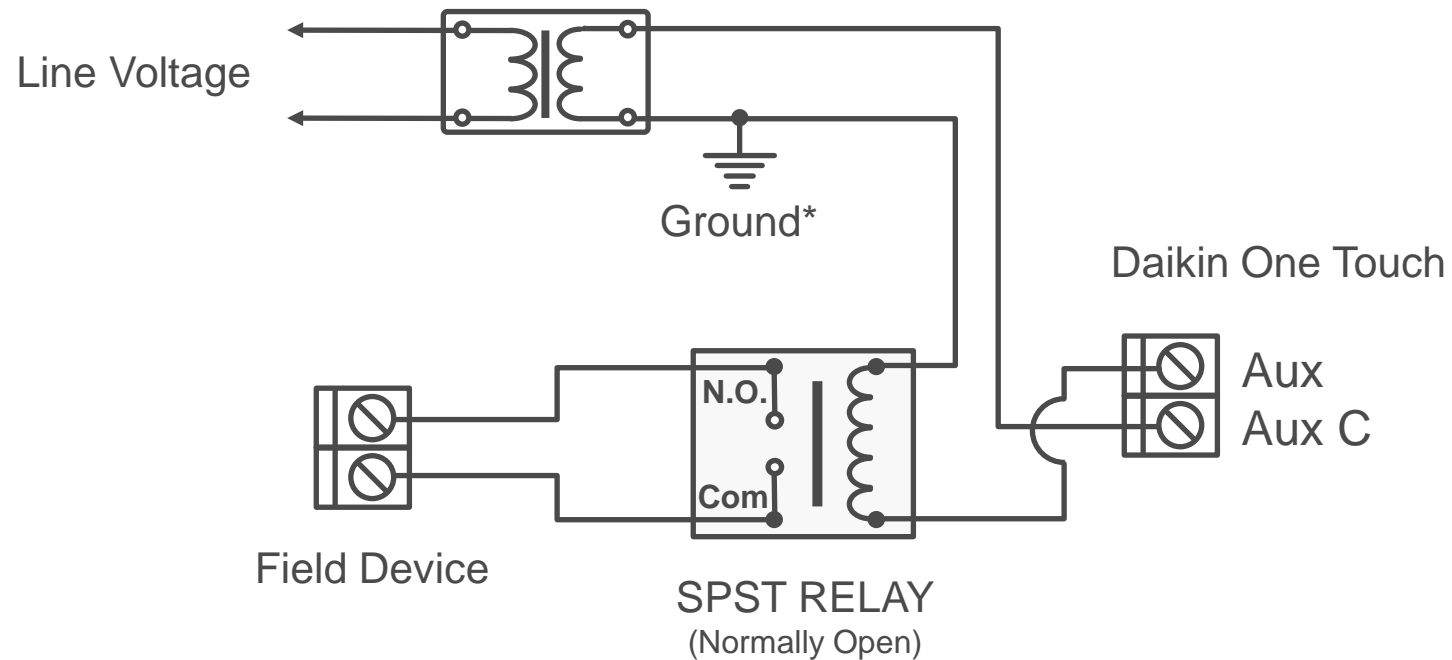

*The terminals are selected in the Daikin One Touch installer wizard.

Note: It is recommended to use a minimum of 18-gauge wire. Maximum operating length of wire is 125 ft.

Agenda

Daikin One Touch

System Configurations

Installing Daikin One Touch

Commissioning Daikin One Touch

Full Set-up

Dealer Navigation

Homeowner Navigation

Mobile Apps

Commissioning Daikin One Touch

- Begin set-up: walks installers through the entire commissioning process to ensure the system is configured properly and ready for the homeowner to use.
 - Enables random access to any setting.
 - Remembers settings as they are entered.
 - Individual may stop and restart as needed.
- The screens are populated based on the model numbers of the equipment, matched to a database of device configuration settings.

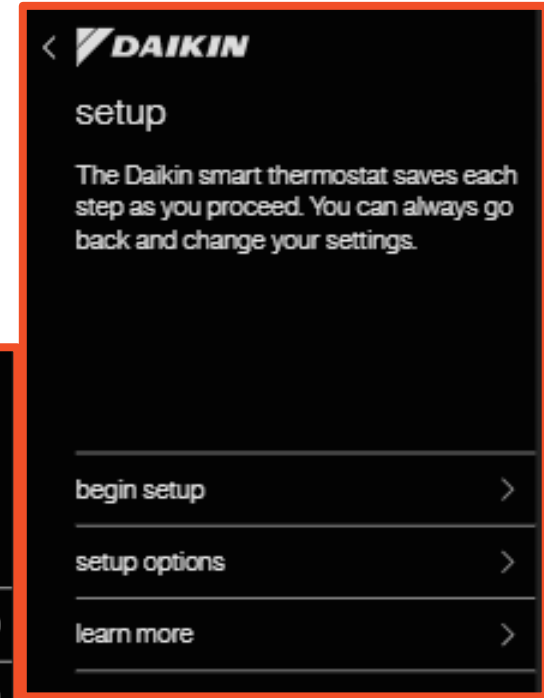
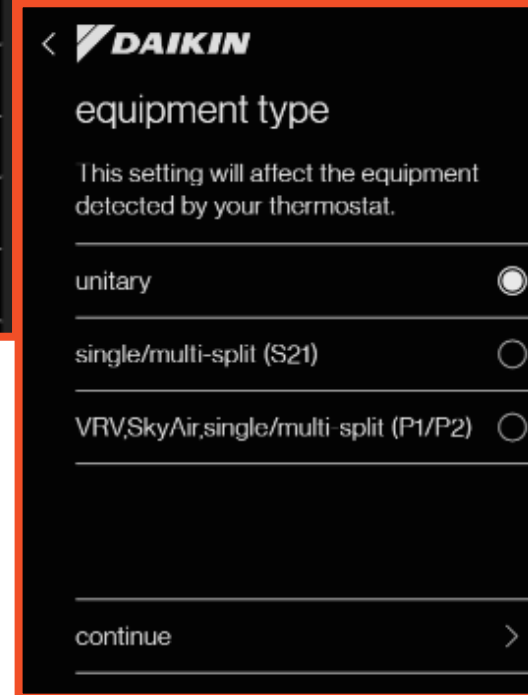
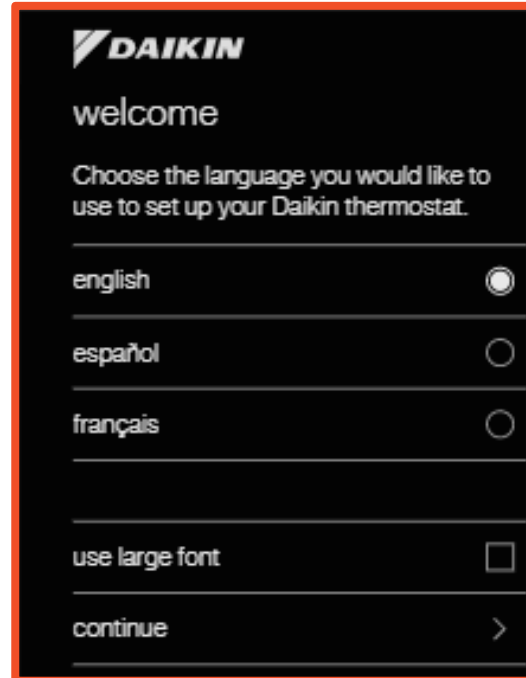

Commissioning Daikin One Touch

- Start-up screen is displayed upon powering the thermostat.
- The welcome screen displays preferences to choose from.
- Version of the thermostat is displayed on the learn more screen.
- Selecting setup options allows you to factory reset the thermostat.

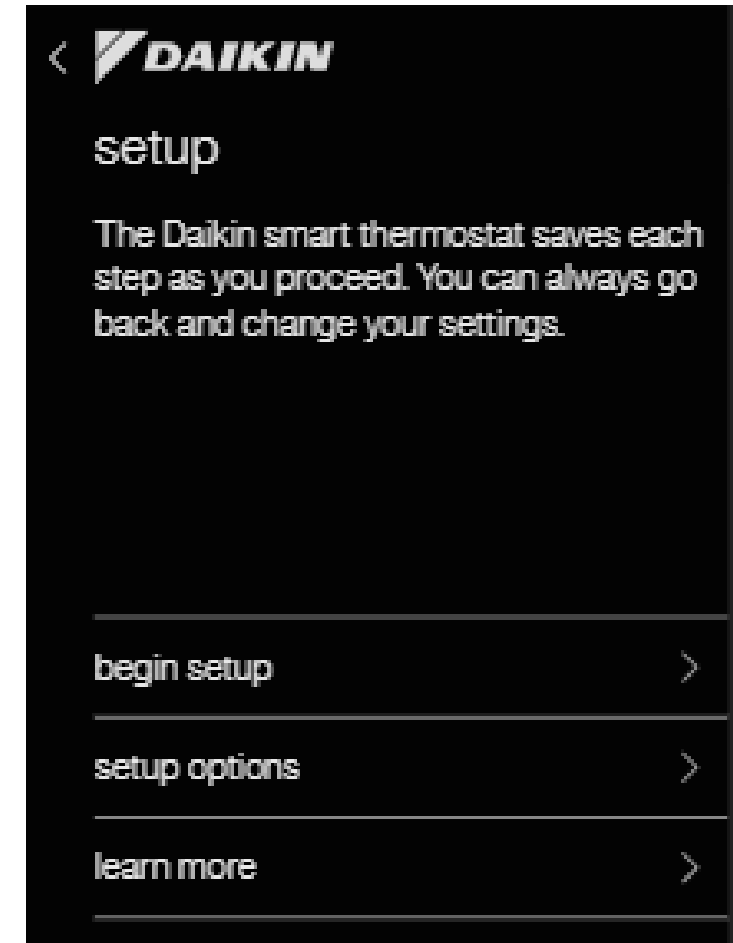
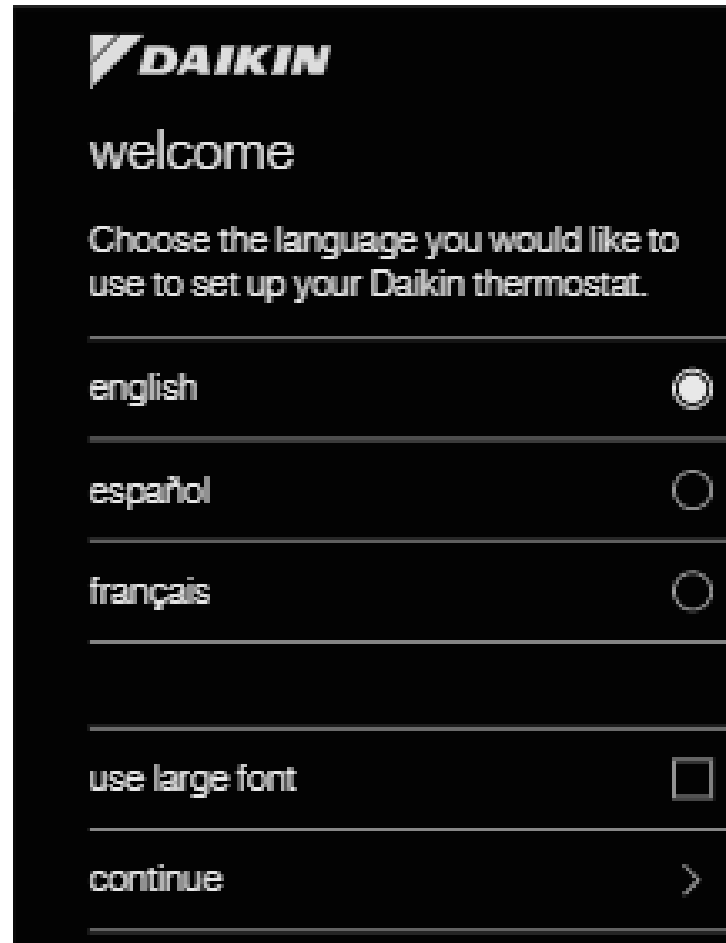

Agenda

Daikin One Touch

System Configurations

Installing Daikin One Touch

Commissioning Daikin One Touch

Full Set-up

Dealer Navigation

Homeowner Navigation

Mobile Apps

Start-up

- **Tapping begin set-up starts the five step set-up process:**
 - Communication.
 - Personalization.
 - Equipment Set-up.
 - System Optimization.
 - Preferences.
- **Note:** All steps must be completed and reviewed before completing set-up to ensure the system is configured properly and ready for the homeowner to use.

For detailed menu settings

<https://daikinone.com/professionals/resources>



Step 1 - Communication

- Configures **Communication Networks**.
- Select home Wi-Fi to search for networks.
- With **Wi-Fi configured**, the system can check the software version and update software to the **latest** version **automatically**.

Note:

- Wireless router must be password protected.
 - Compatible with 5Ghz routers which supports 2.4Ghz
- Equipment type displays the equipment selected on start up.

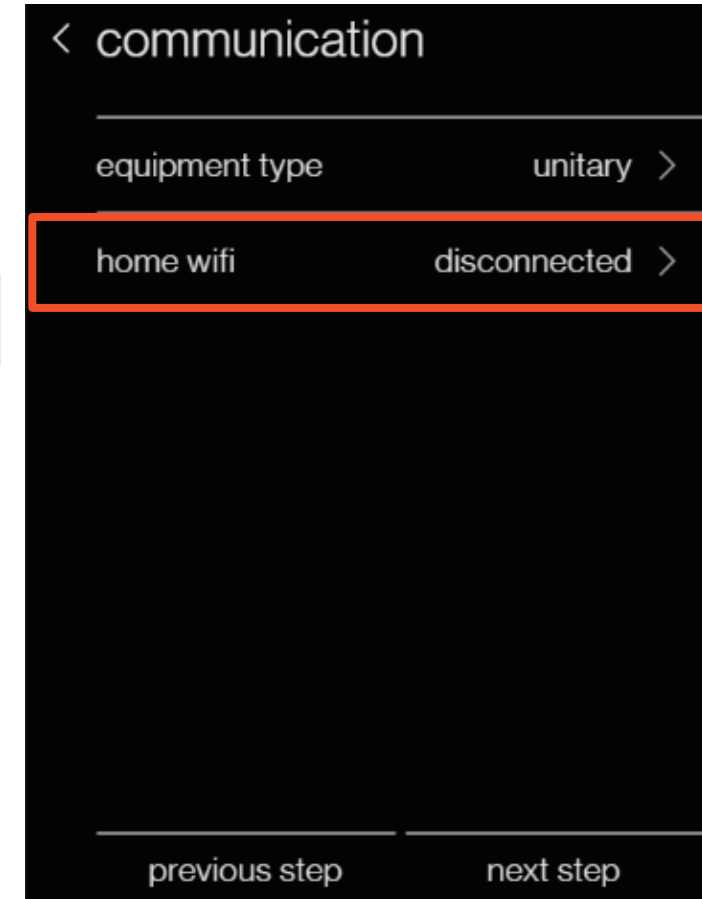
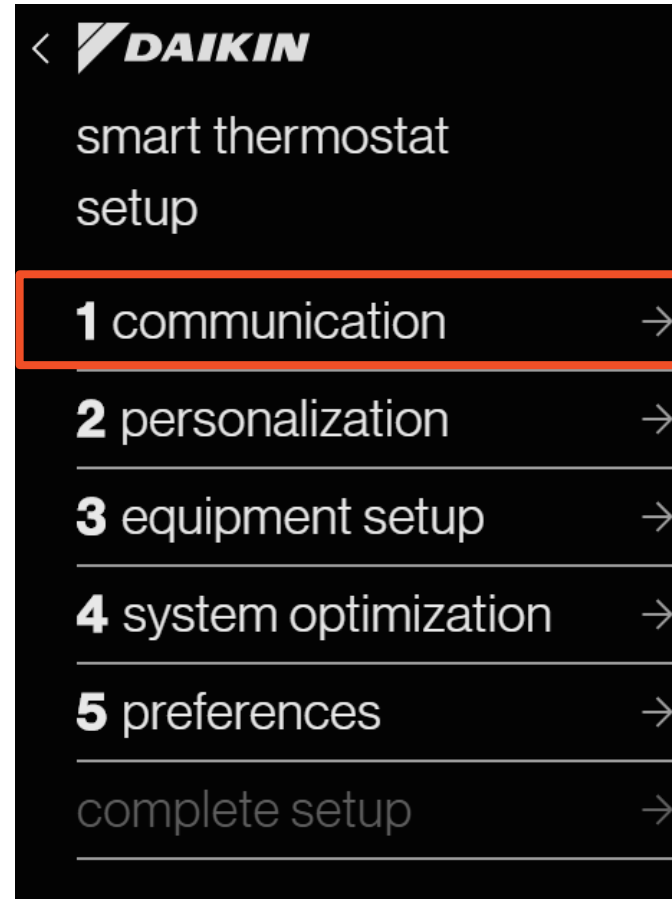

Step 2 - Personalization

- Tapping the **personalization tab** allows you to edit default information.
- Personalization displays:
 - Language.
 - Large font selection.
 - Date & Time.
 - If Wi-Fi is connected, date & time sets automatically.
 - Thermostat Name.
 - Degree Units.

Note: A green check mark appears next to items reviewed from the set-up menu.

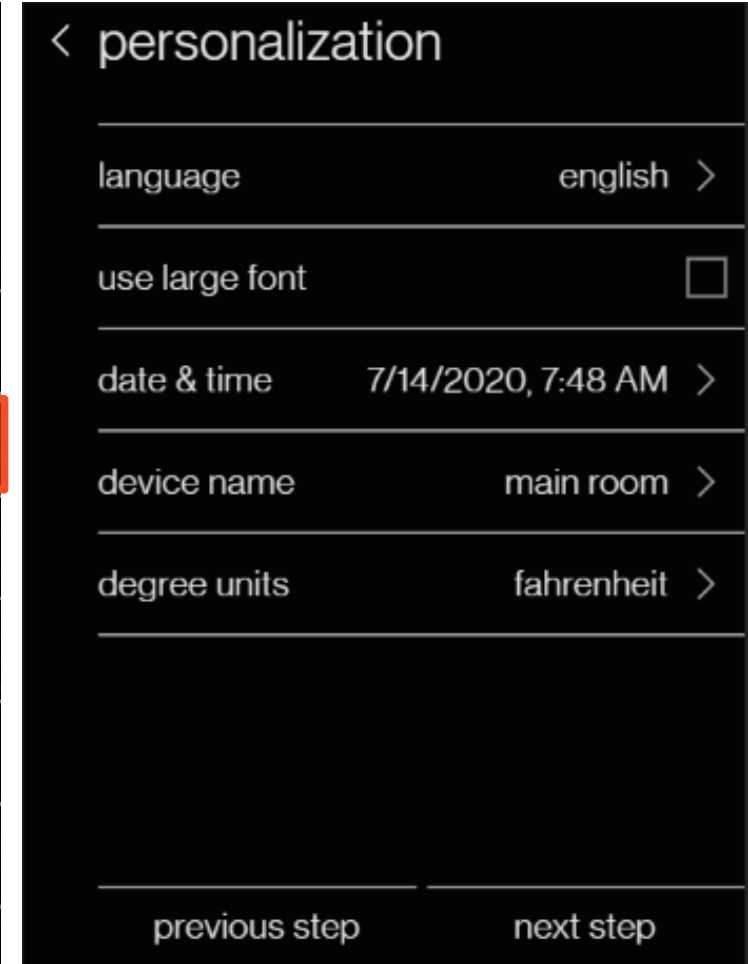
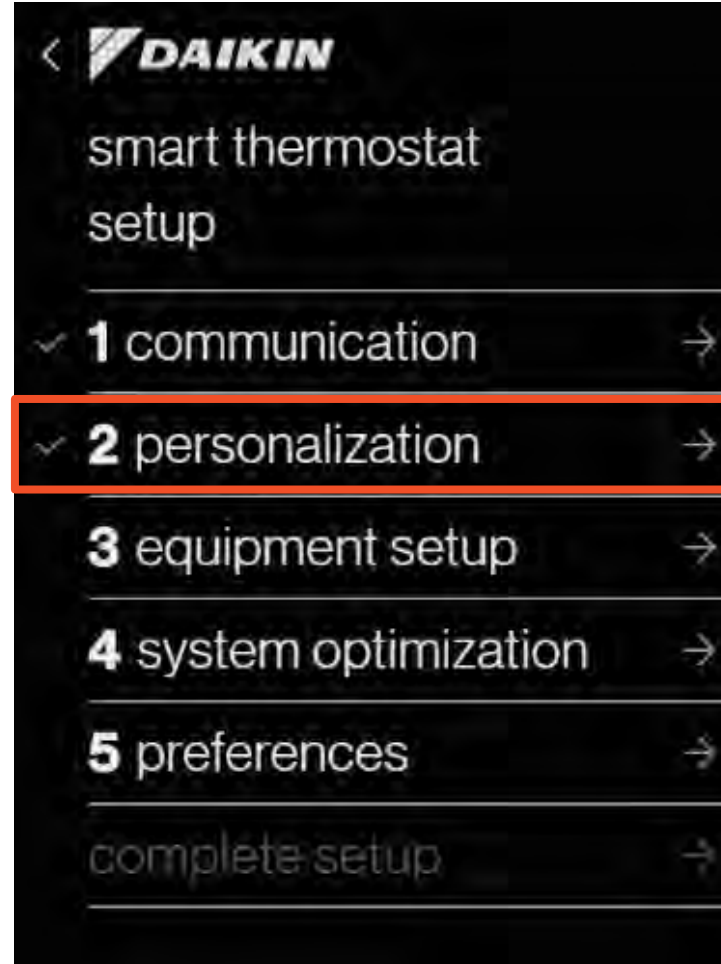

Step 3 - Equipment Set-up

- Displays equipment found by searching the communication network, or by adding/removing equipment and accessories from the preset list.
- The unit that is identified determines the list of configurations that will be displayed
 - View unit Specifications.
 - Configure
 - Cool settings
 - Heat Settings
 - Heat Pump Settings
 - Humidifier Relay
 - Aux alarm
 - Heater Kit

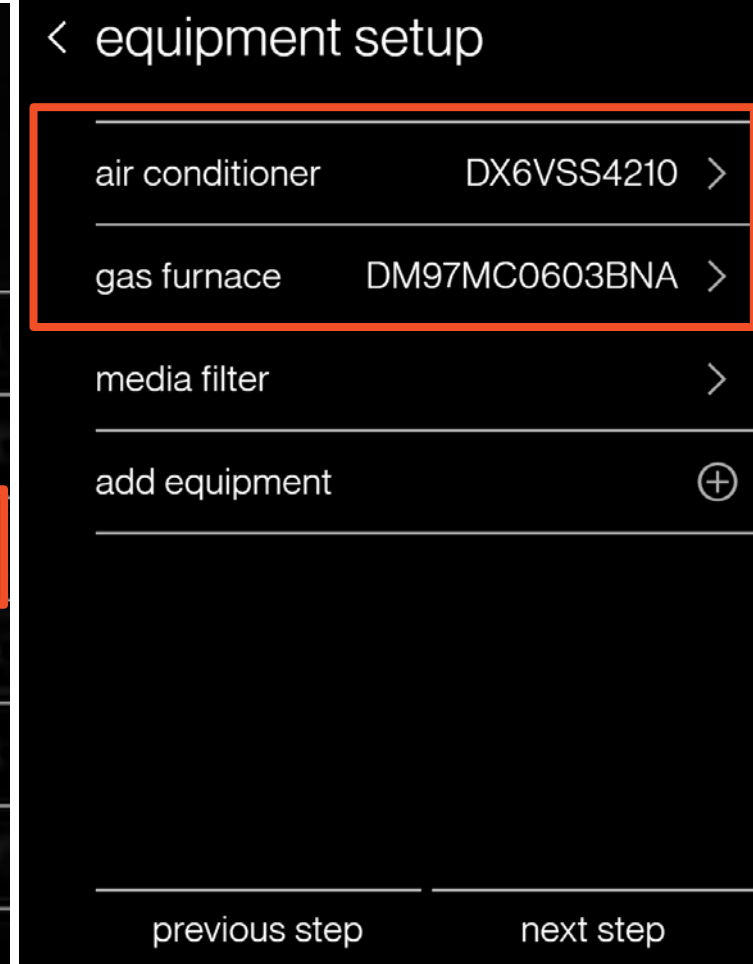
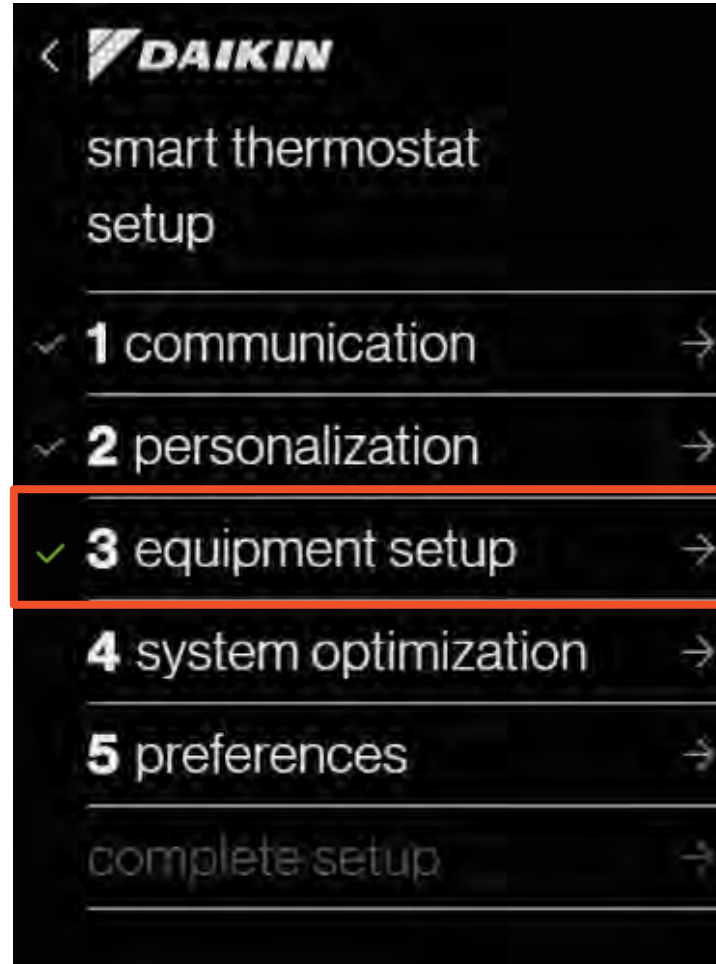

Added Equipment

- The Daikin *One+* smart thermostat is compatible with multiple accessories.
 - Air quality sensor
 - Humidifier
 - Dehumidifier
 - You can install the humidifier and dehumidifier by using aux 1 or 2
 - Recommend using an isolation relay between auxiliary device and thermostat.
 - UV Bulb
 - Electronic Filter
 - HEPA filter
 - EWC Zone Board.

Humidifier



Air Quality Sensor



EWC Zone Board

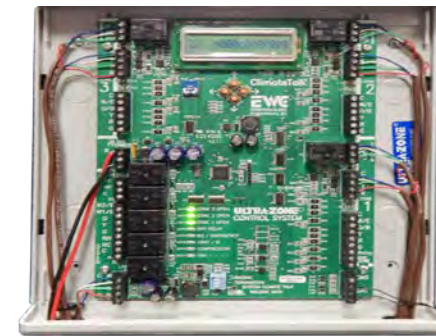

Dehumidifier



Add Equipment – Auxiliary Heat

- Selecting add equipment will allow you to configure an auxiliary heat source.

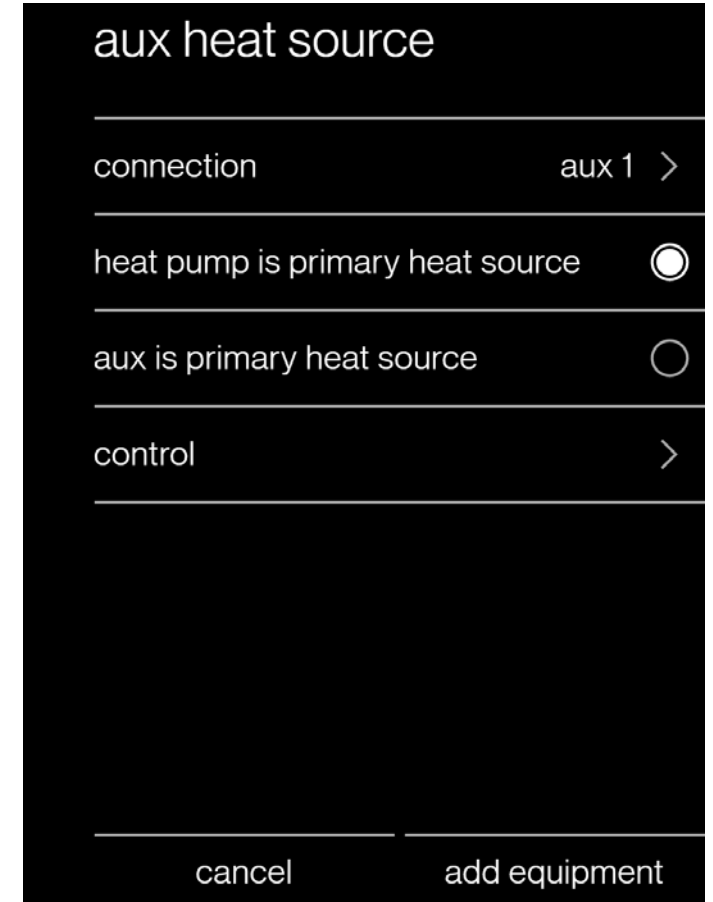
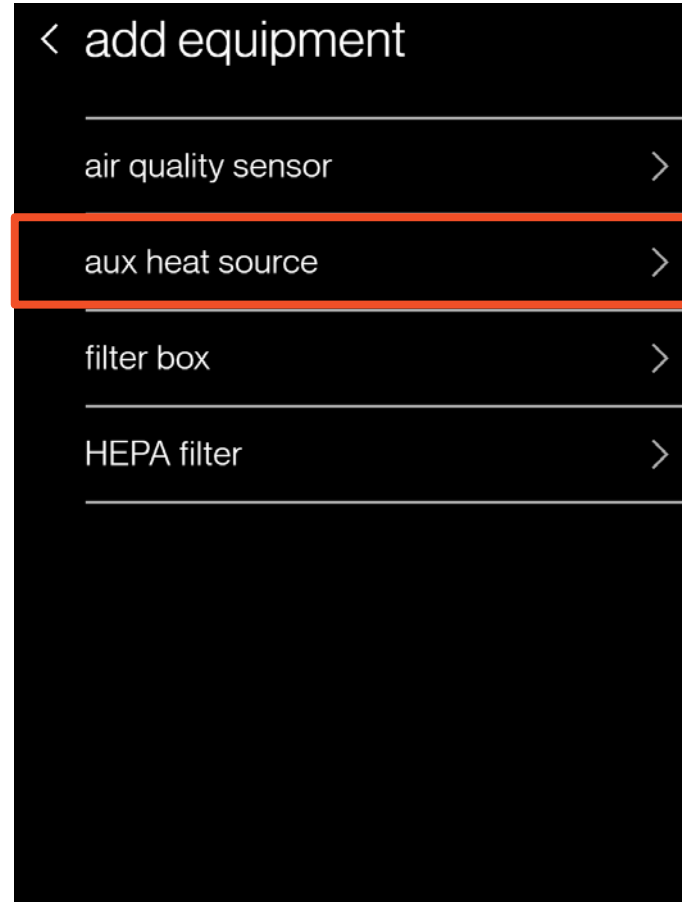
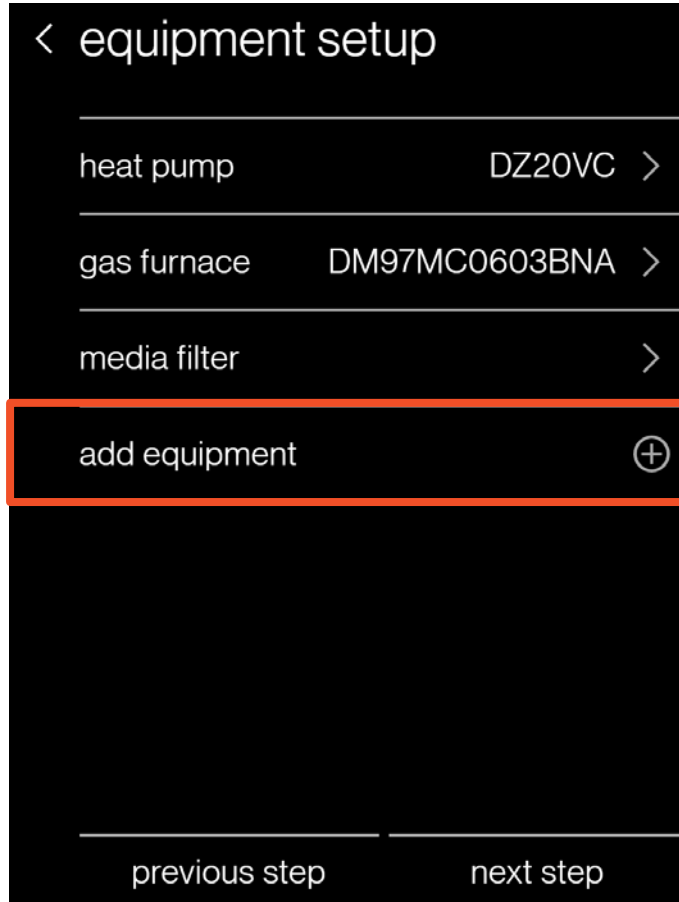

Secondary Heat Settings

- The control section will allow you to adjust settings such as lockouts and secondary heat activation temperature.

***Emergency Heat mode will appear as a system mode when connected to heat pump units and can be used to directly turn on the aux heat source if enabled.**

< control

heat pump lockout 15°F >

aux heat lockout 50°F >

use T on / T off

indoor unit fan enabled

fan speed high >

fan on delay 30 sec >

fan off delay 10 sec >

< aux heat lockout

enable aux heat lockout

Locks out AUX heat above this temperature, unless HP not operational.

45

50 °F

55

Must be at least 10°F above heat pump lockout temp.

T on/T off Control

- T on and T off provide an alternative control method to have the main AC/heat pump control the aux heat source using its PI control algorithm.
- T on/T off is the only control option for AC- only outdoor units
 - If the indoor unit is a gas furnace, or is an air handler with a heater strip, these heat sources will be controlled around the heat setpoint by the demand-based algorithm.
 - The aux heat source will be controlled independently.

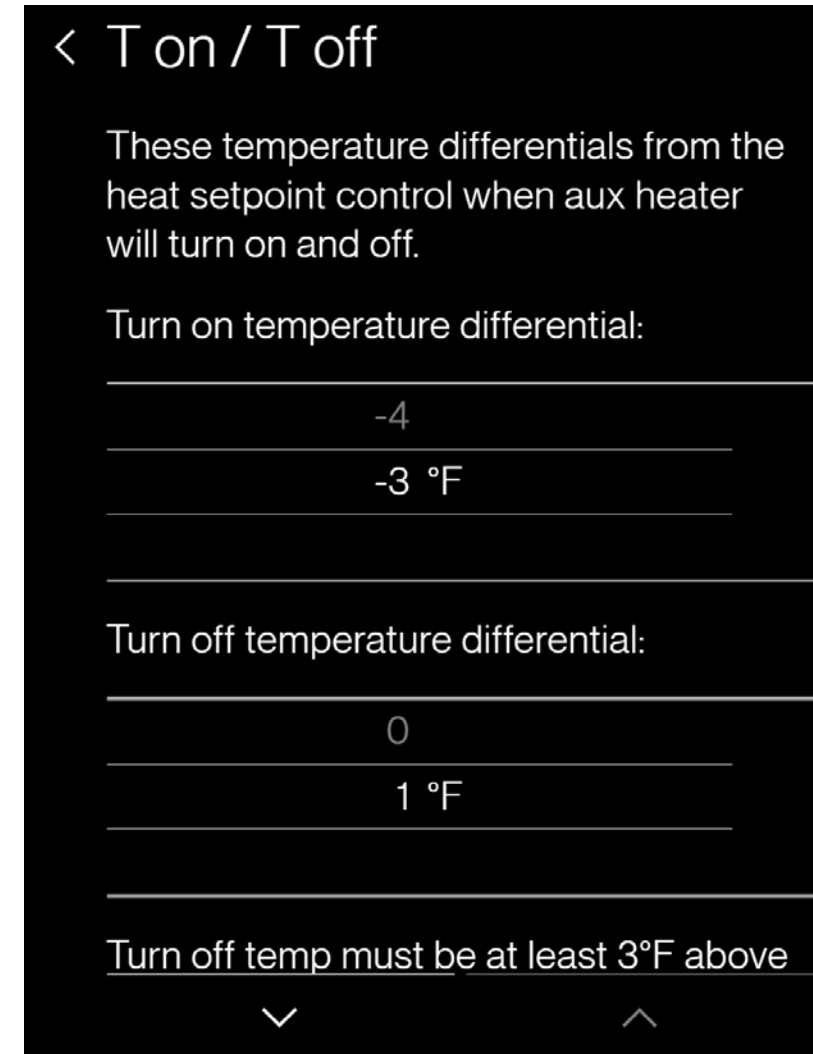
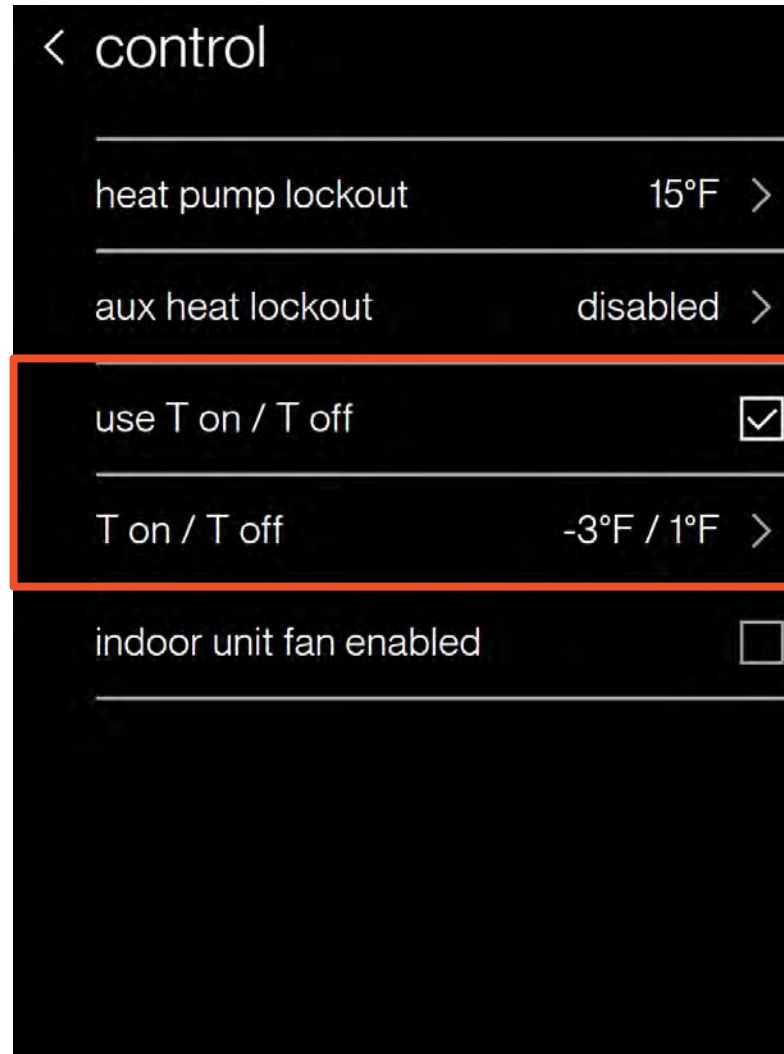

Aux Heat Control

- When heat pump is the primary heat source:
 - Heat pump lockout temperatures are adjustable from -20°F to 65°F in 5°F increments. (default 15°F)
 - Auxiliary heat lockout temperatures are adjustable from -10°F to 75°F in 5°F increments. (default 50°F)

Auxiliary heat demand:

- T on differential is adjustable from -7°F to -3°F in 1°F increments (default -3°F)
- T off differential is adjustable from -4°F to 1°F in 1°F increments (default 1°F)

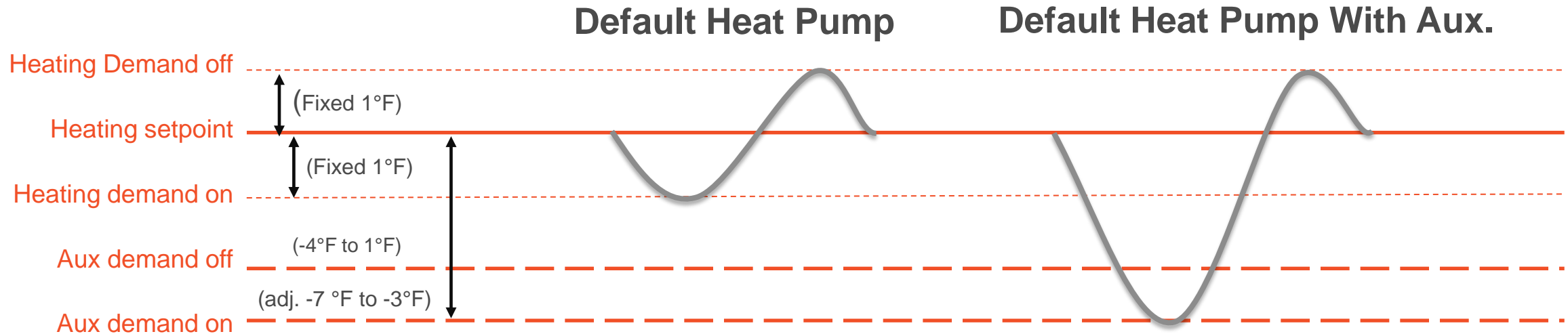

Aux Heat Control

- When auxiliary heat is the primary heat source:
 - Heat pump lockout temperatures are adjustable from -20°F to 65°F in 5°F increments. (default 15°F)
 - Setpoint differential can be set at -9°F , -7°F , -4°F , and -2°F (default -2°F)

Heat pump demand:

- T on differential can be set at -1°F or -2°F (default -1°F)
- T off differential 1°F fixed

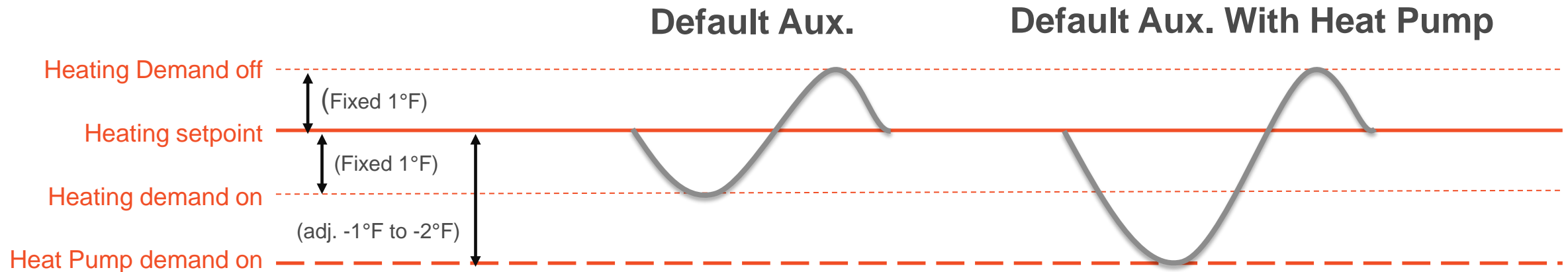

Step 4 – System Optimization

- System optimization displays:
 - System test.
 - Inverters only.**
 - Charge mode.
 - Inverters only.**
 - Optional test.
 - Error history.
 - Logs alerts with an error code.
 - White = not critical**
 - Yellow = critical**
 - Calibration. **Thermostat must be in OFF mode.**
 - Wait 30 minutes before calibration for the thermostat to equalize.**
 - Status.

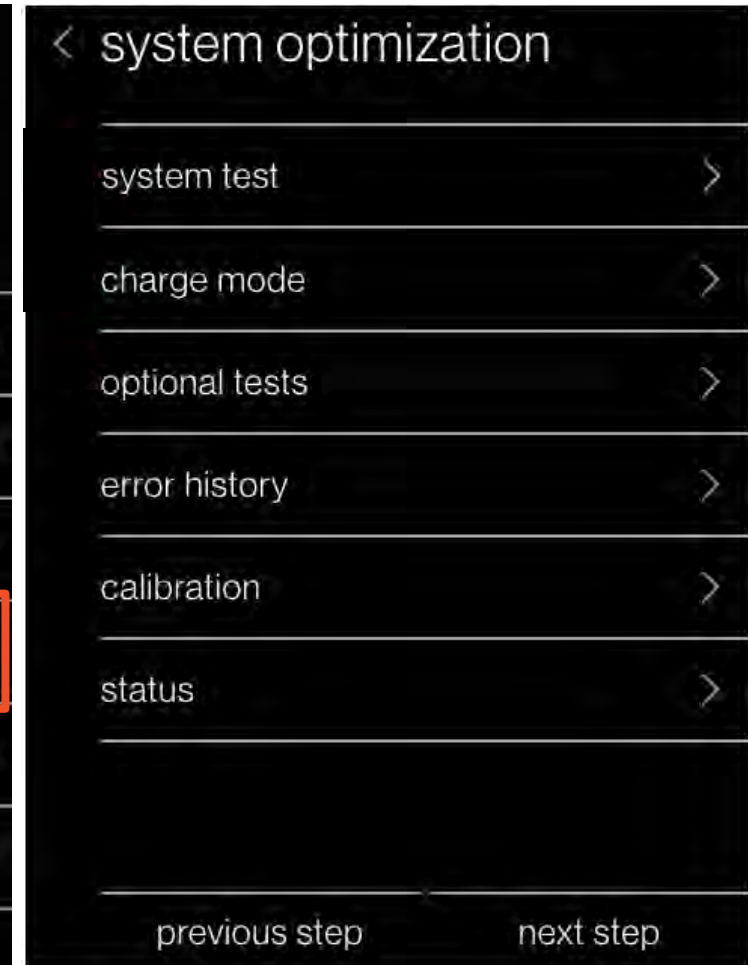
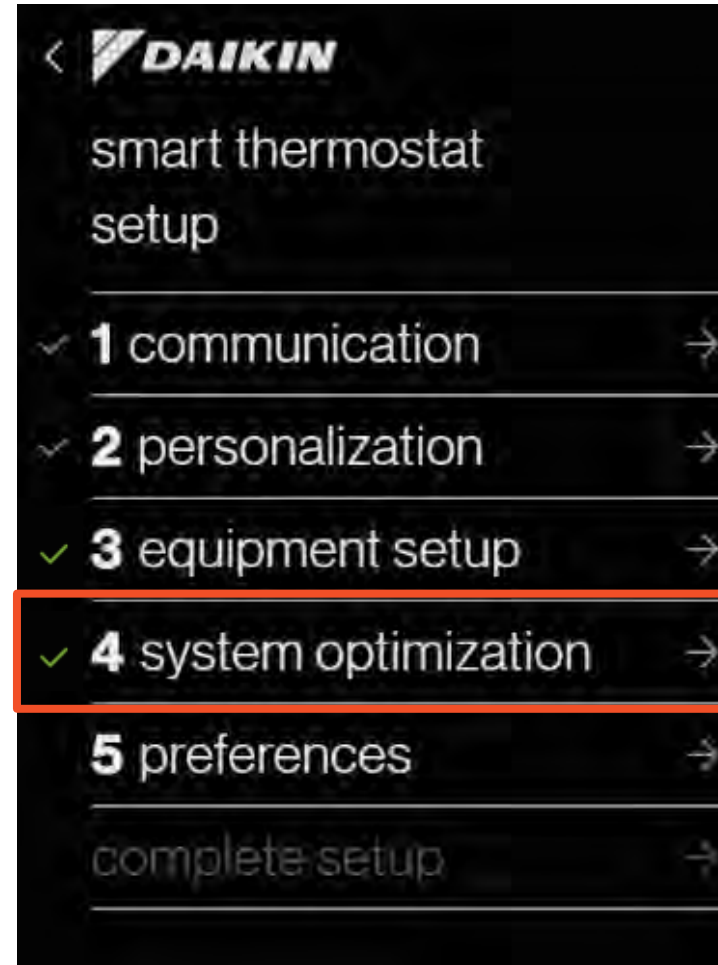

System Test

- The system test must be run for the **inverter units** before proceeding to complete set-up.
- To proceed through the set-up process, the system test needs to be completed without any errors.
- When the tests are completed, the run test screen is displayed.
 - System test is complete only when display code E11 notice clears from the seven segment LED display on the heat pump or air conditioner.

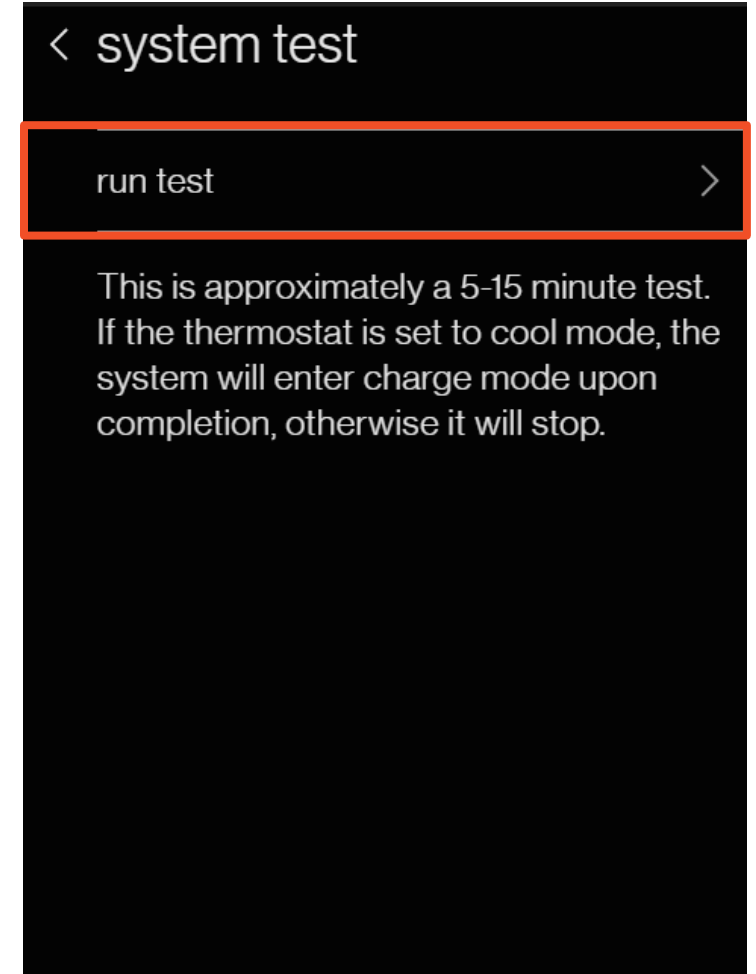
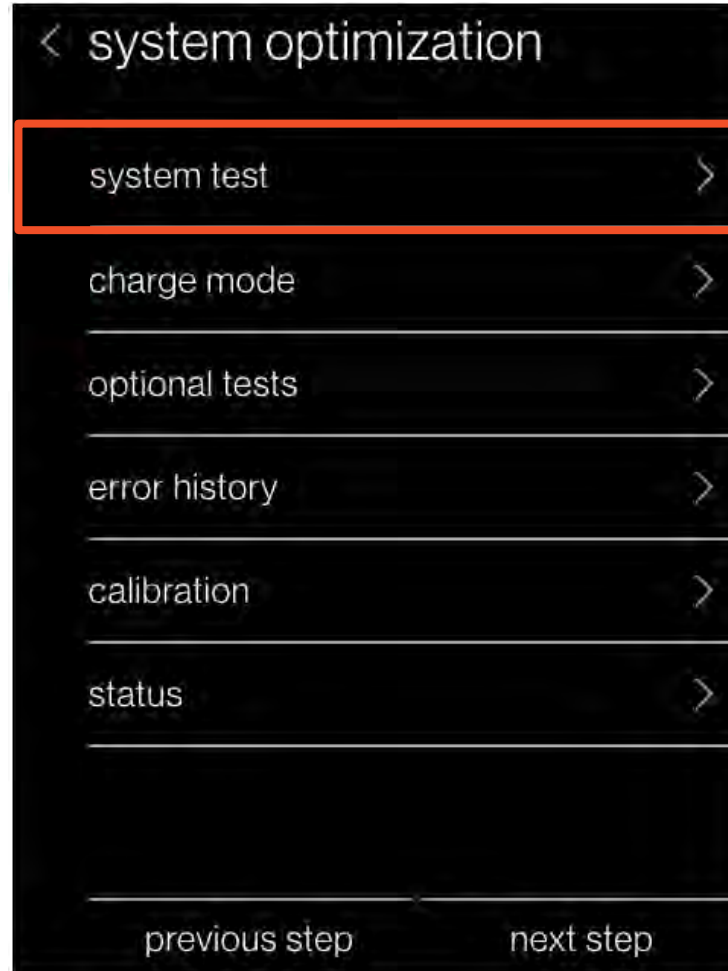

Charge Mode

- Selecting charge mode allows for a steady system operation to allow for refrigerant charging of the system via the suction charge port.
- The system will stop when the “stop test” button is pressed or once the test is complete.

Note: For proper charging of a system, please see equipment installation manual.

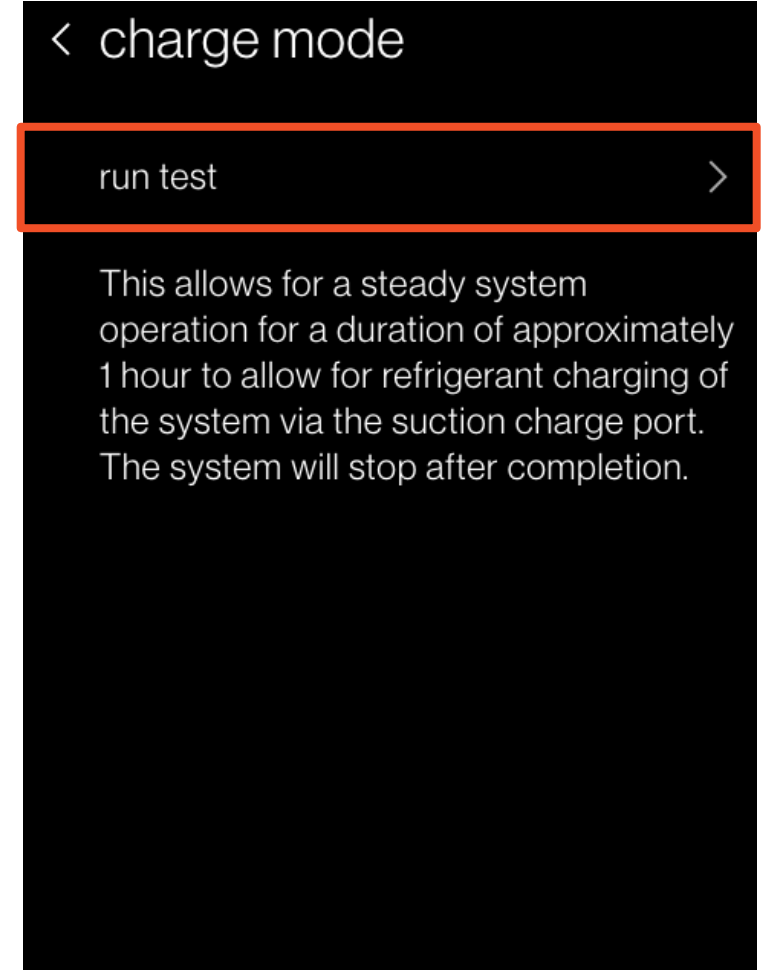
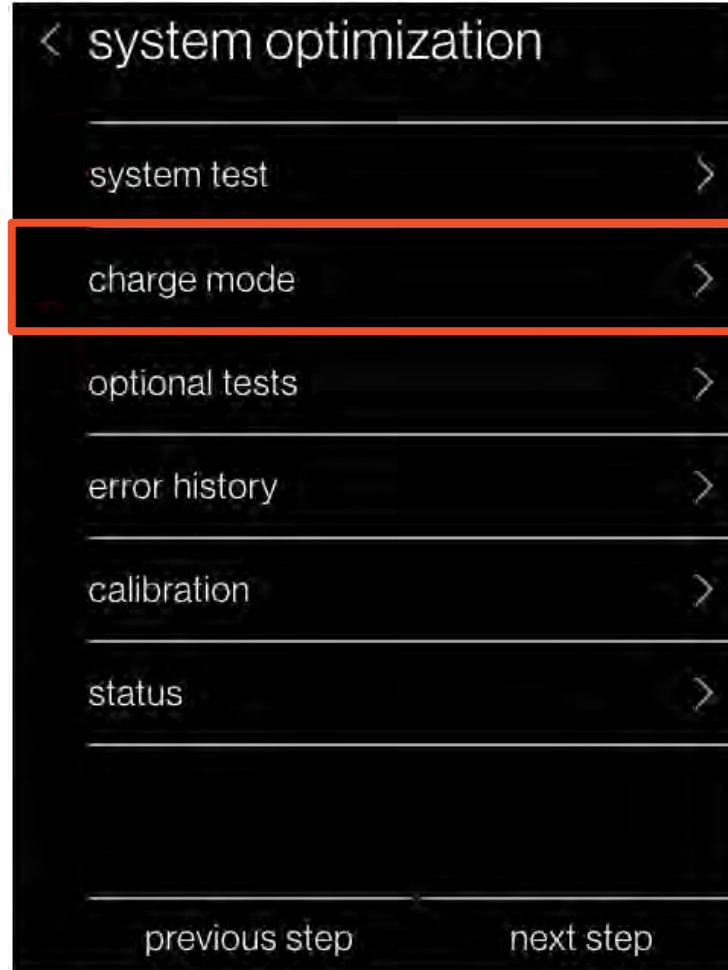

Optional Tests

- Each optional test has a short description.
- Optional tests display a stop test button while test is running.

Note: Thermostat will only display tests that the system can perform.

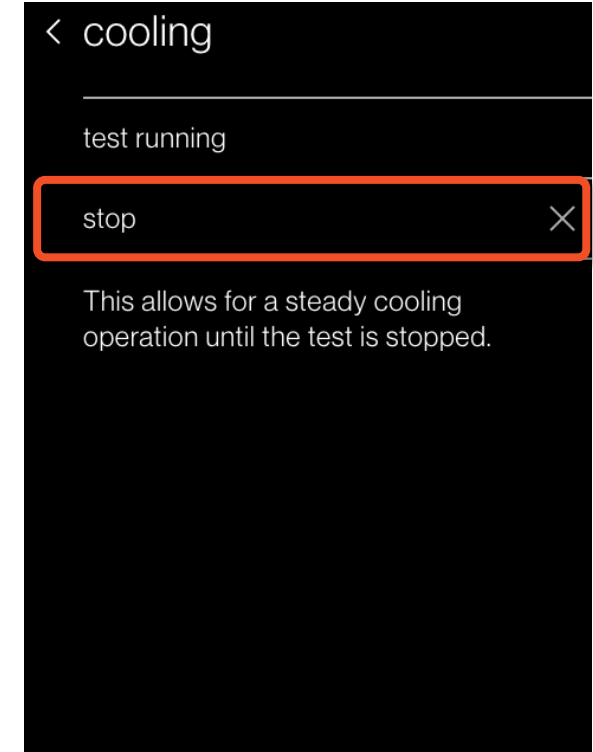
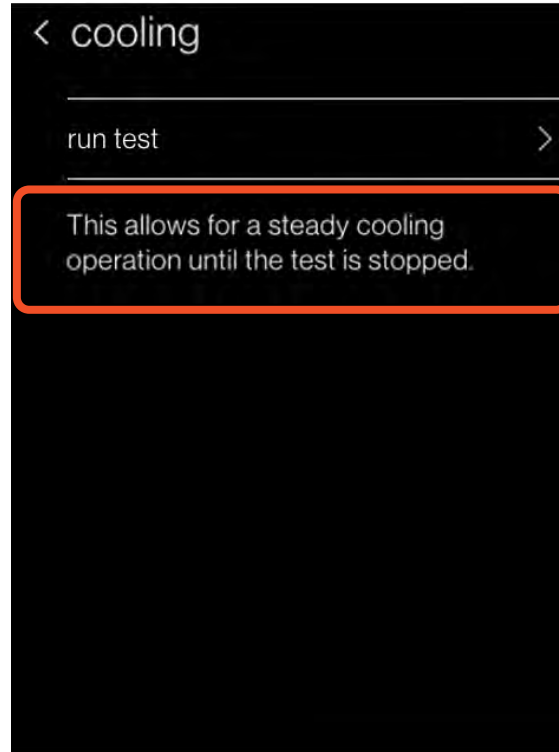

Status

- The status menu displays data pertaining to the selected equipment.
- The scrollable list can be accessed any time by returning to the installer set-up screen.

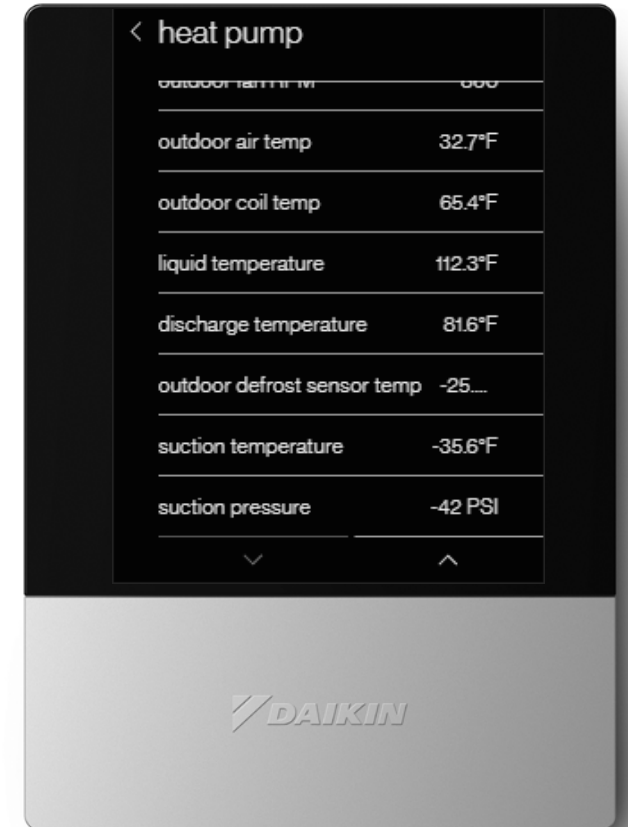
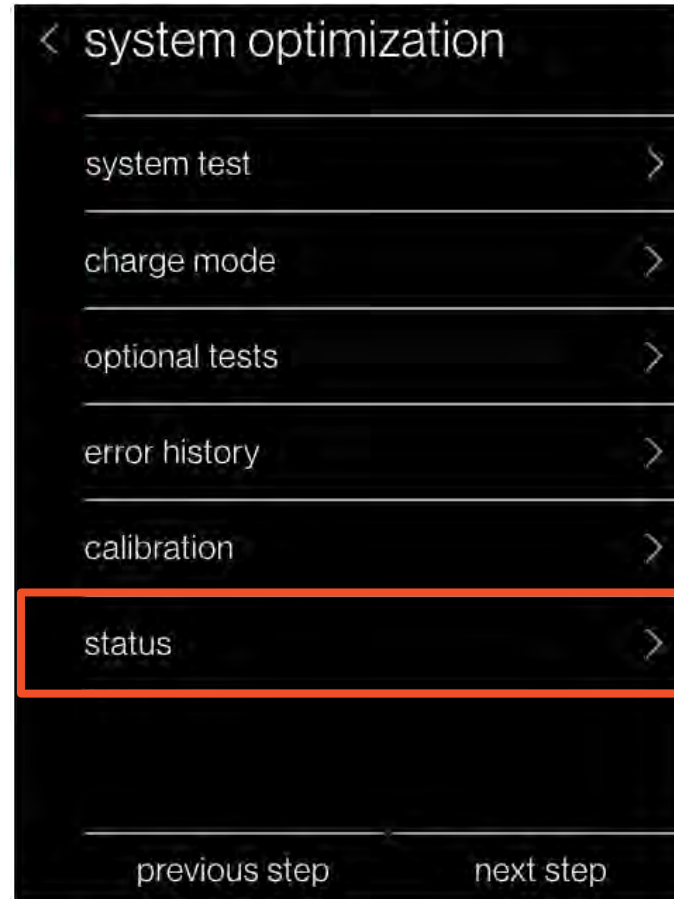

Step 5 - Preferences

- There are four preference settings to choose from in order to optimize your systems performance.
 - Cool/Heat
 - House settings
 - Dealer information
 - Reminders

Note: Changing preferences is not required, but reminders and dealer contact information should be inputted.

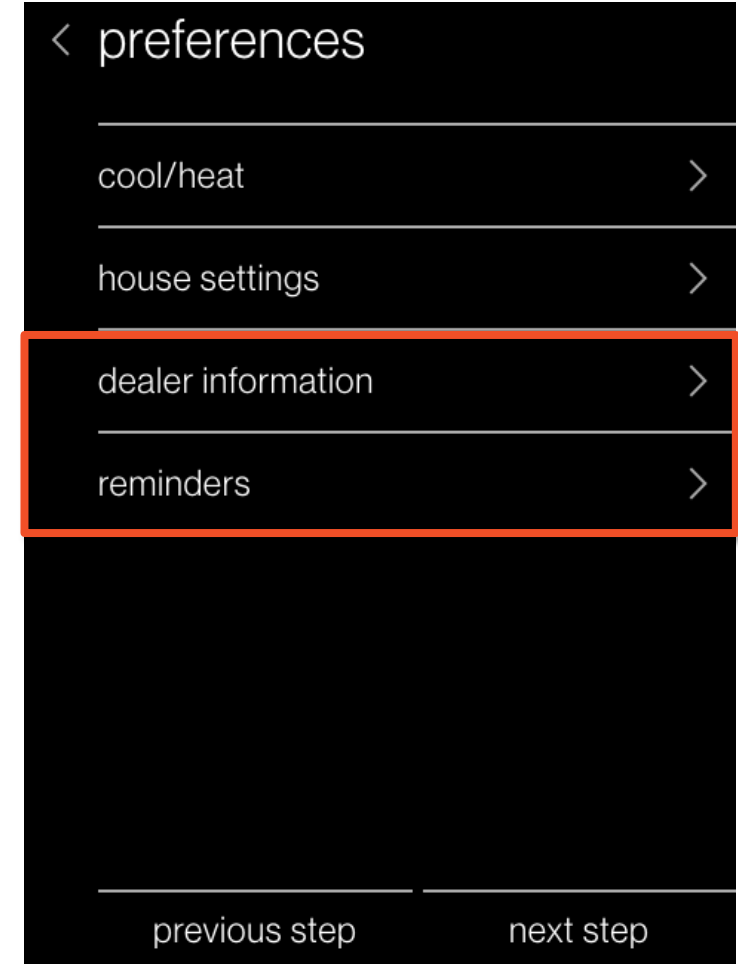
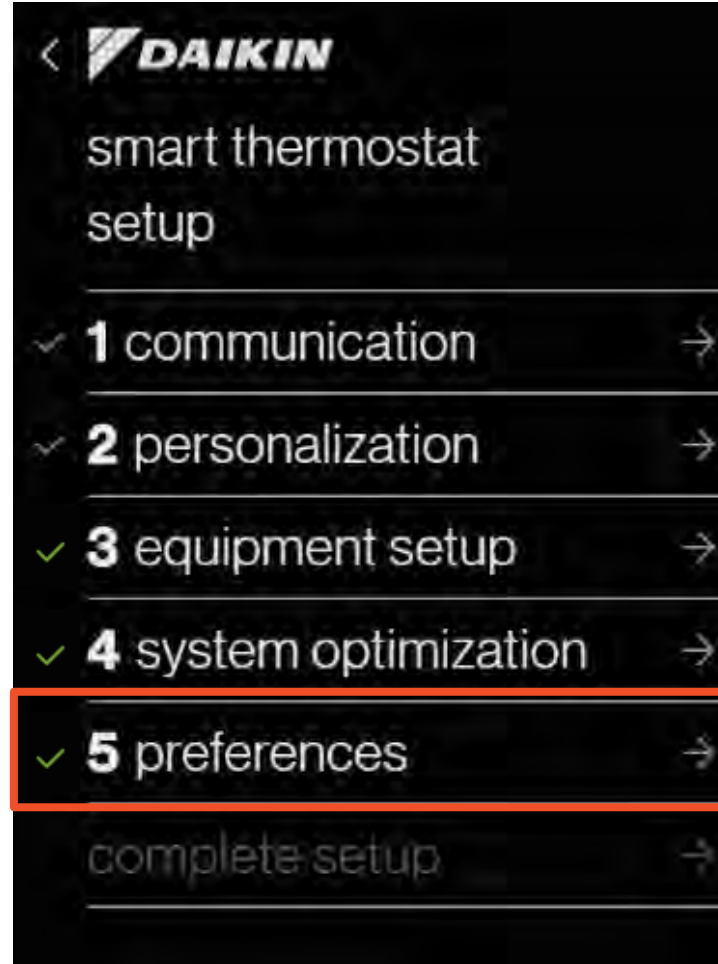

Dealer information

- Selecting allows you to enter and review the dealer's information.

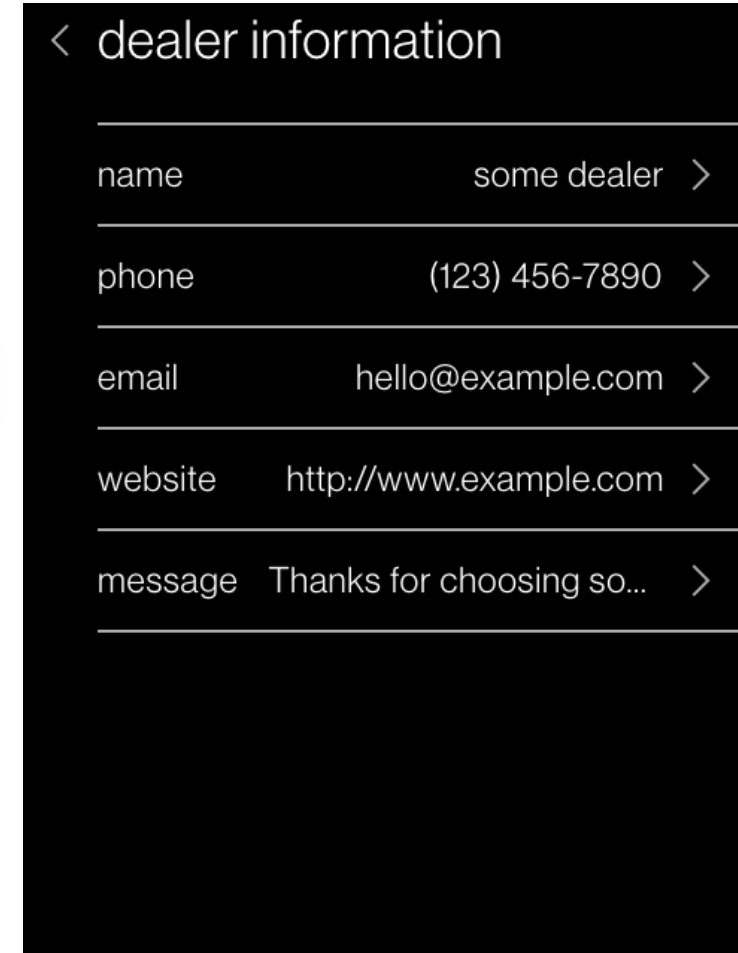
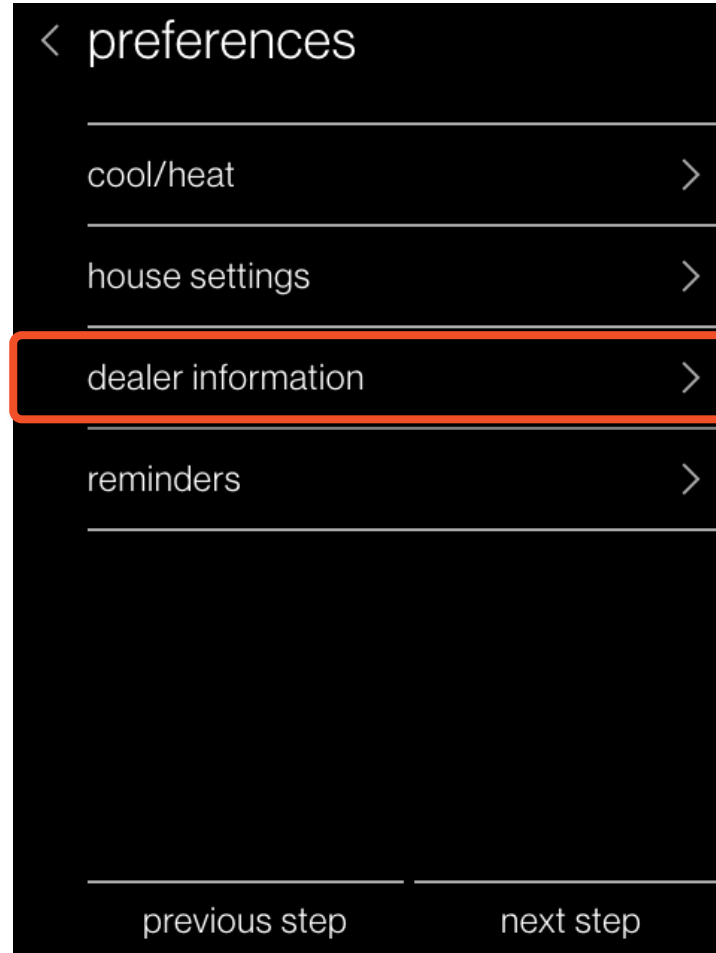

Reminders

- The number of reminders are based on the installed equipment with accessories.
- Once the equipment has been added, a **1 – 24** month service reminder can be selected depending on the installed equipment.

Note: The homeowner cannot edit service reminders.

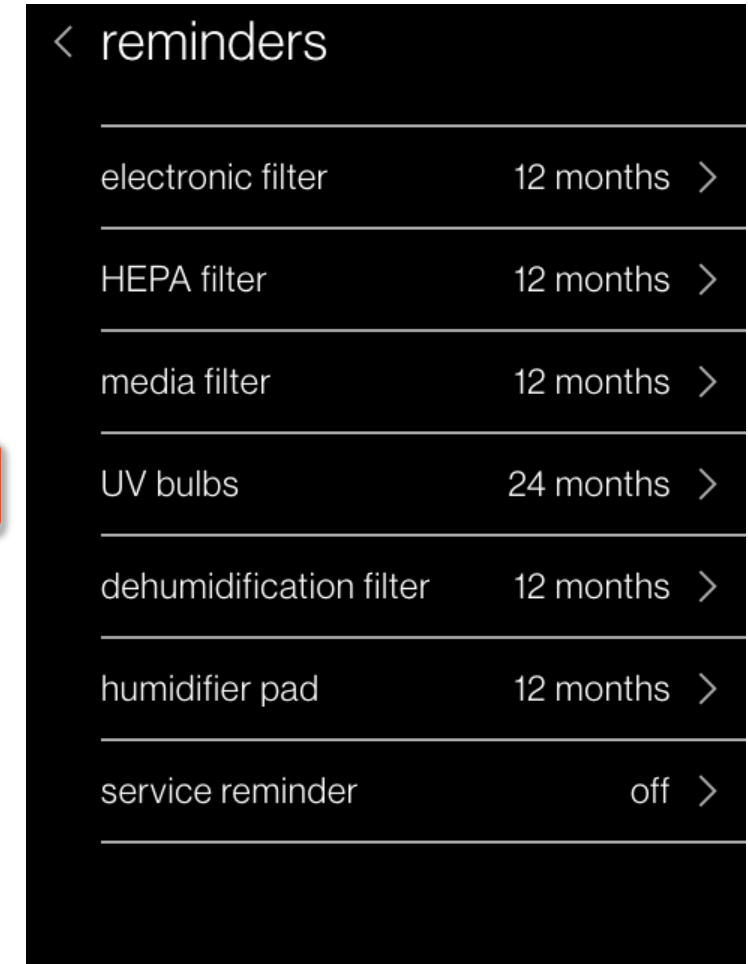
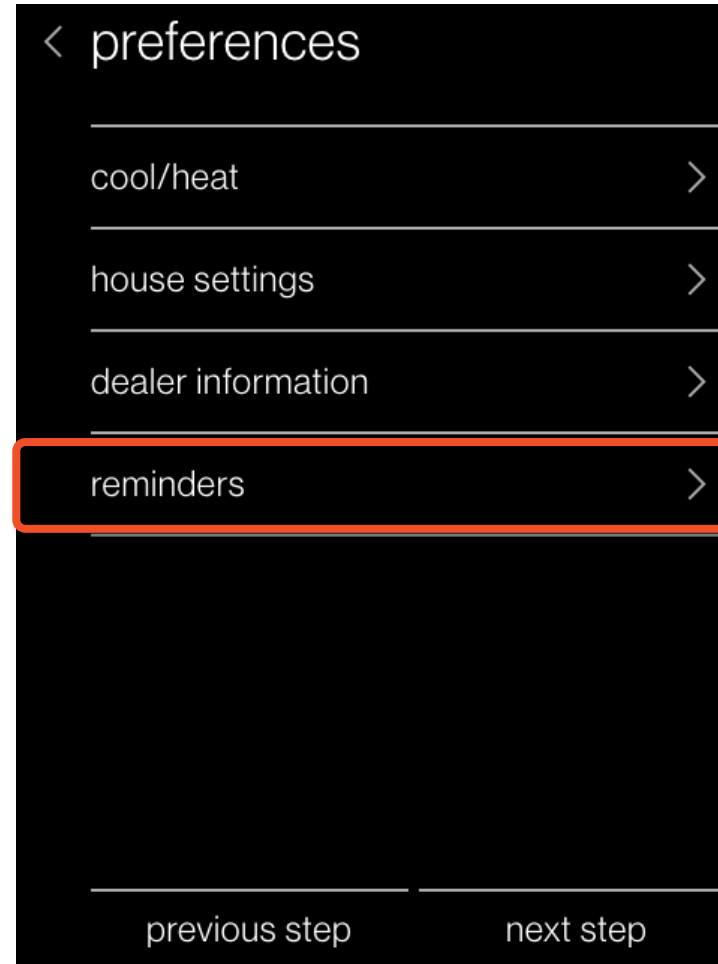

Final step - Complete set-up

- Selecting complete set-up will conclude the full set-up of the thermostat and display normal mode for you to navigate and verify settings.

Reminder: All steps must be reviewed before completing full set-up.

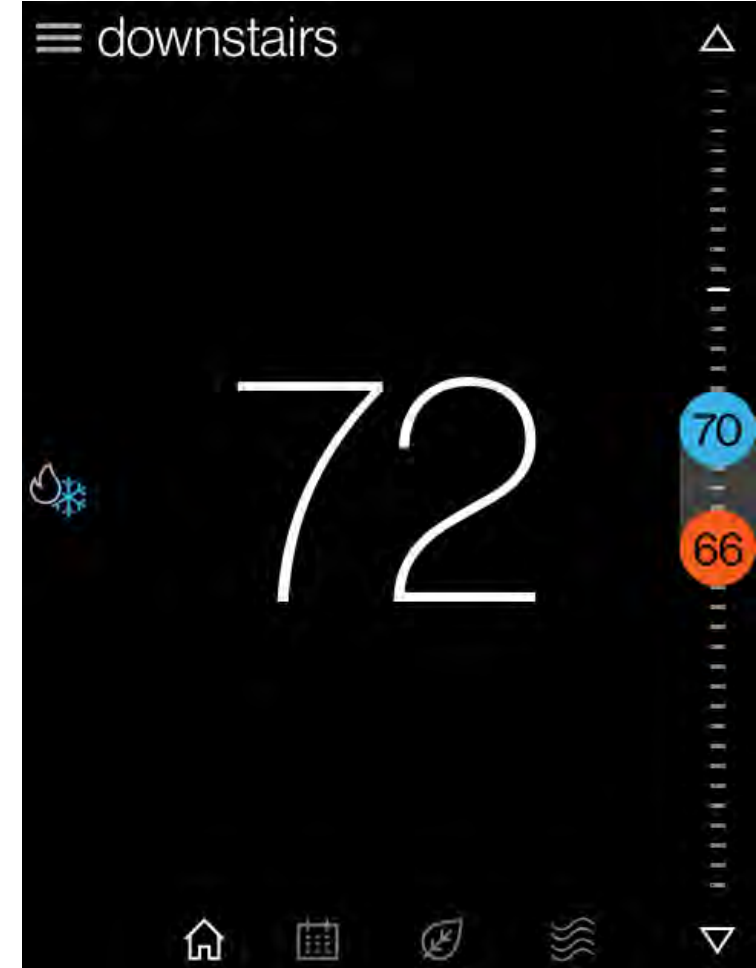

Agenda

Daikin One Touch

System Configurations

Installing Daikin One Touch

Commissioning Daikin One Touch

Full Set-up

Dealer Navigation

Homeowner Navigation

Mobile Apps

Dealer Navigation

Dealer edit

- Navigating to dealer edit will allow you to access or revisit the installer set-up screen.
- Advanced adjustments to the Daikin *One+* will be made here.

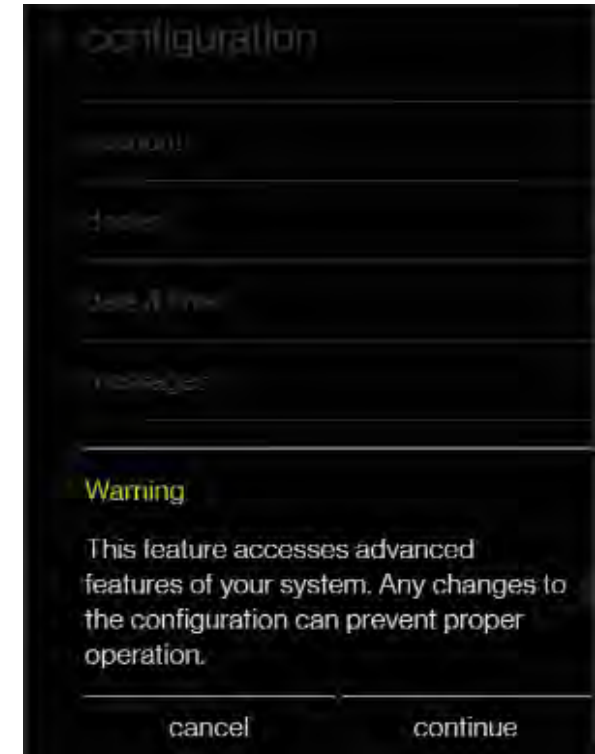
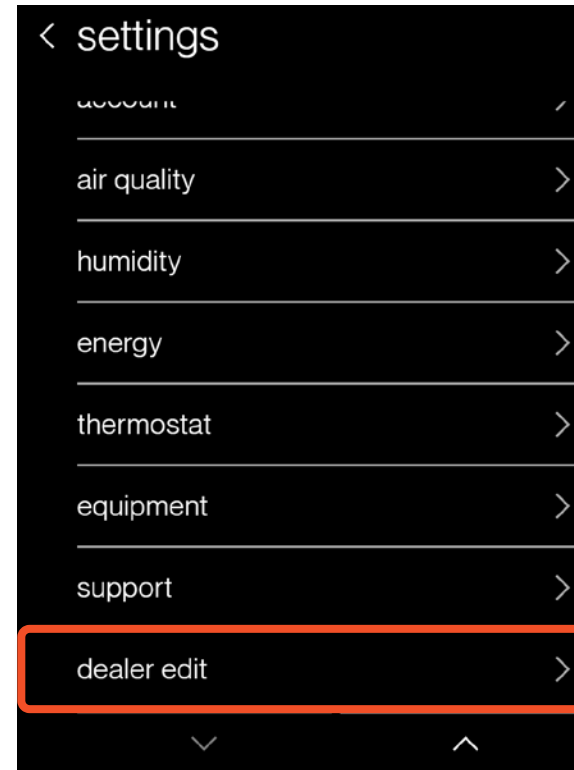
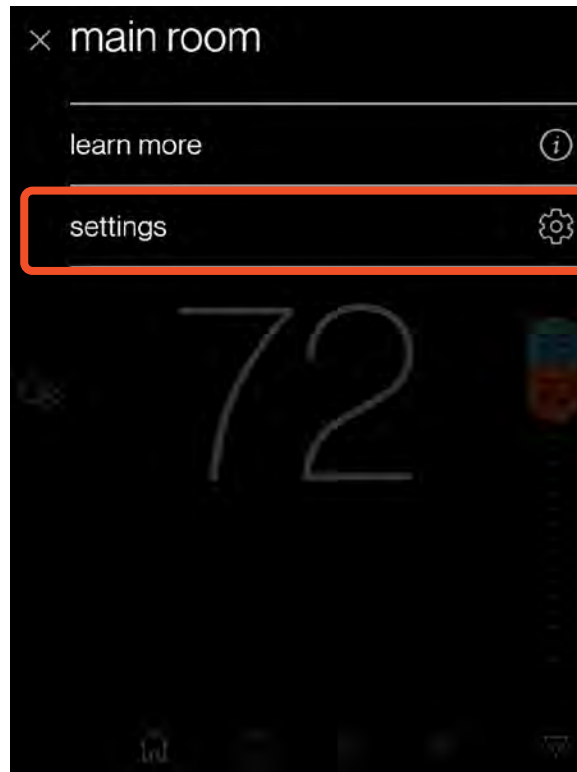
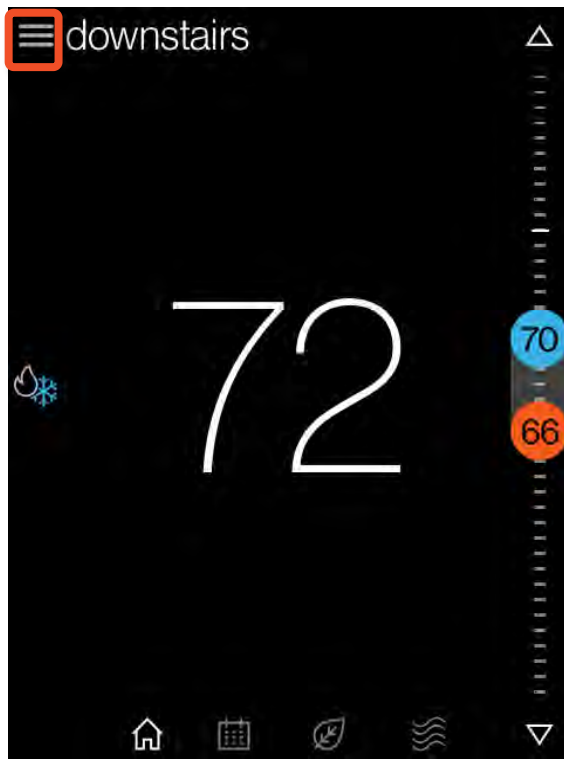

Dealer Navigation

- Acknowledging the prompt enables you to tap the learn more icon.
- The icon displays the installer code, giving you access to the installer set-up screens.

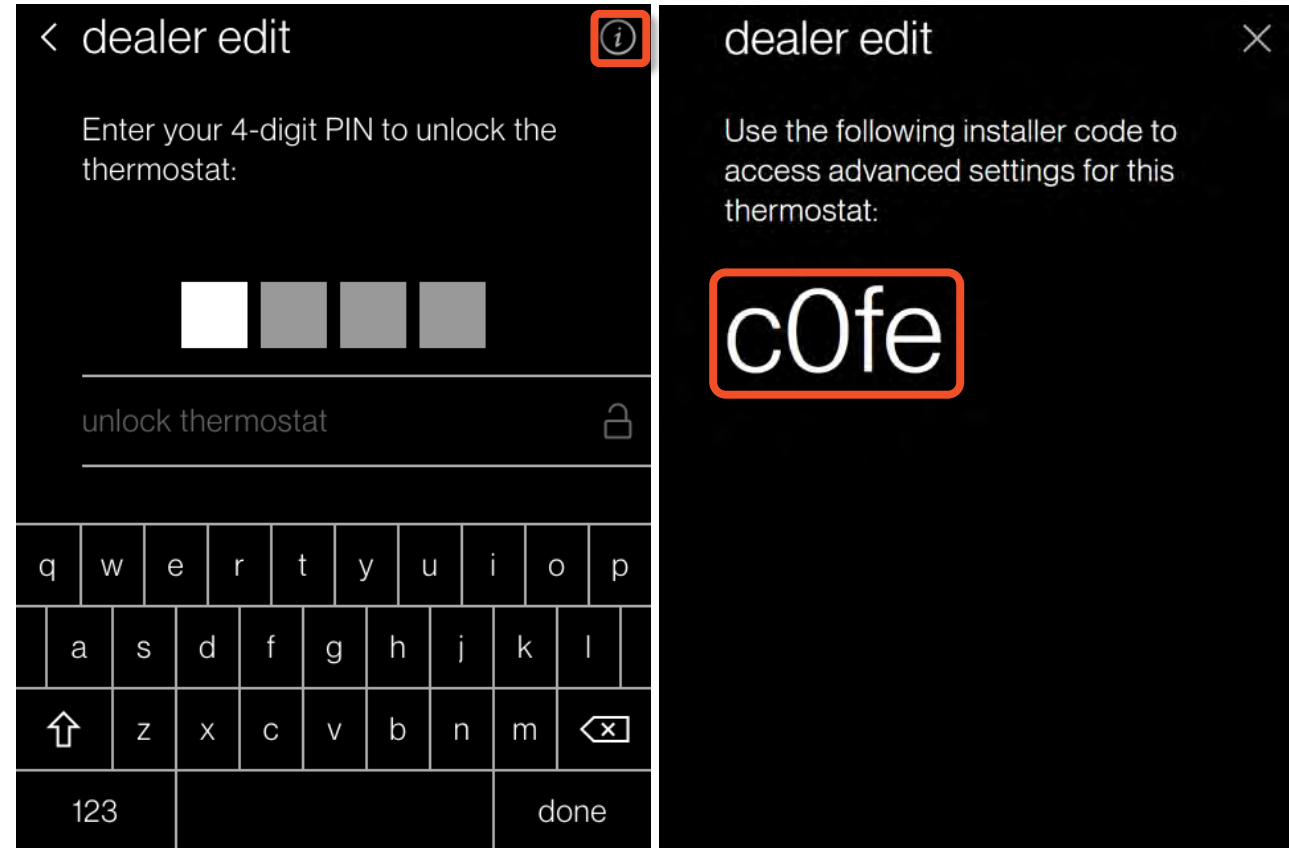

Agenda

Daikin One Touch

System Configurations

Installing Daikin One Touch

Commissioning Daikin One Touch

Full Set-up

Dealer Navigation

Homeowner Navigation

Mobile Apps

Homeowner Navigation

Normal mode

- Normal mode allows you to view messaging, temperature, and access settings to adjust parameters placed by the installer.
- Navigating is accomplished by tapping icons.

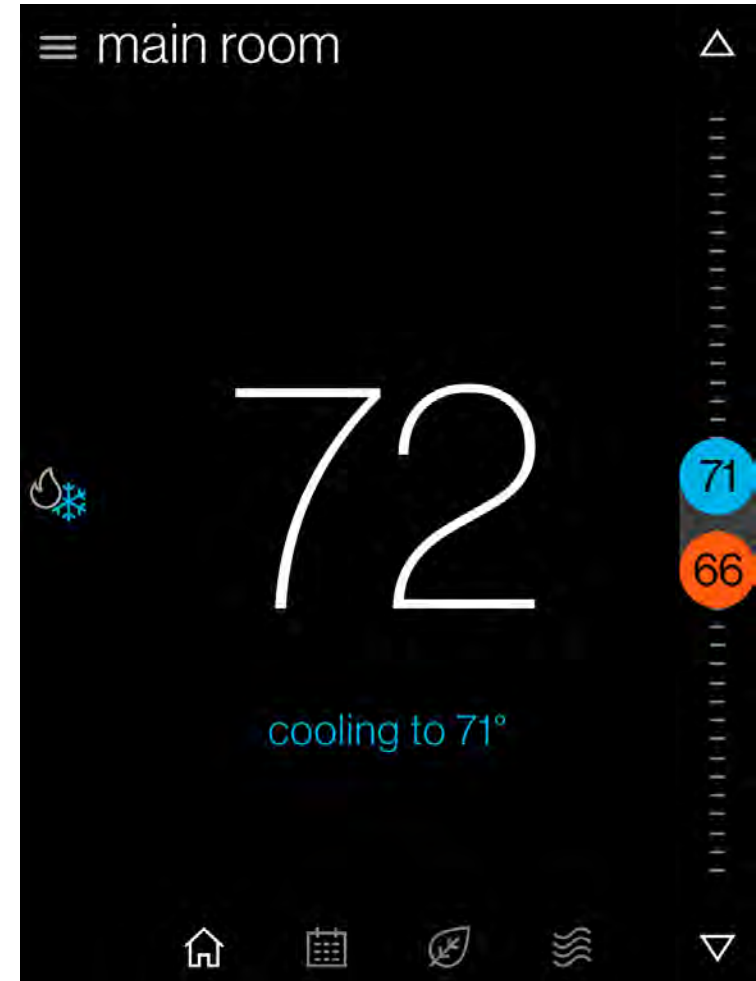

Adjust control

- Tapping the system mode icon allows you to select:
 - Auto. (cool & heat)
 - Cool.
 - Heat.
 - Off.
 - Emergency heat. (heat pump only)
- Tapping the arrow will adjust setpoints that are displayed. You can also tap, hold, and slide the setpoint icons to the desired temperature.

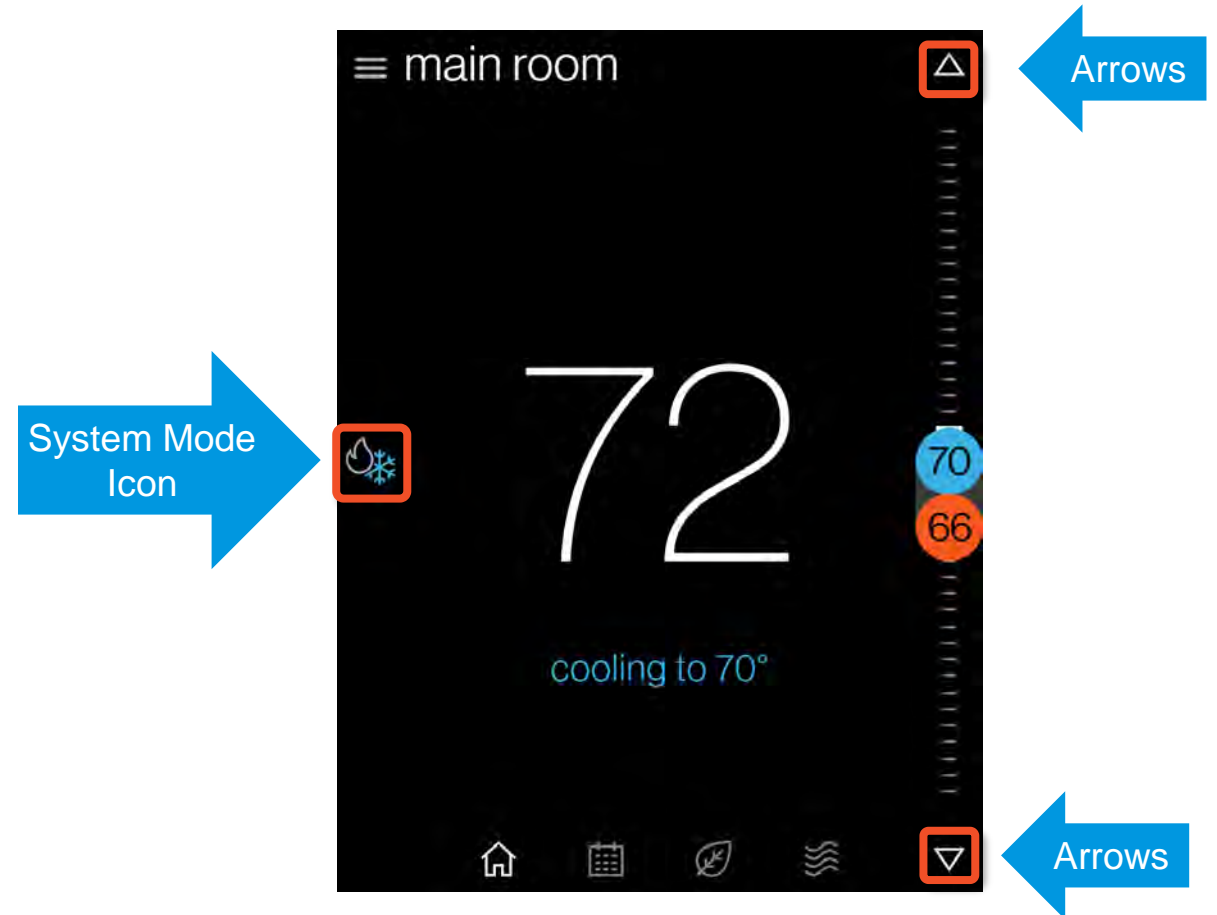

Schedule

- The schedule is presented as 7 days, displaying one day at a time, with 24 hours fitting on the screen.
- You can use the drop-down menu or swipe to enable schedule editing.
- Copy and paste is a feature that makes scheduling seamless.

Note: Unlike other screens, scheduling requires saving edits before exiting the mode.

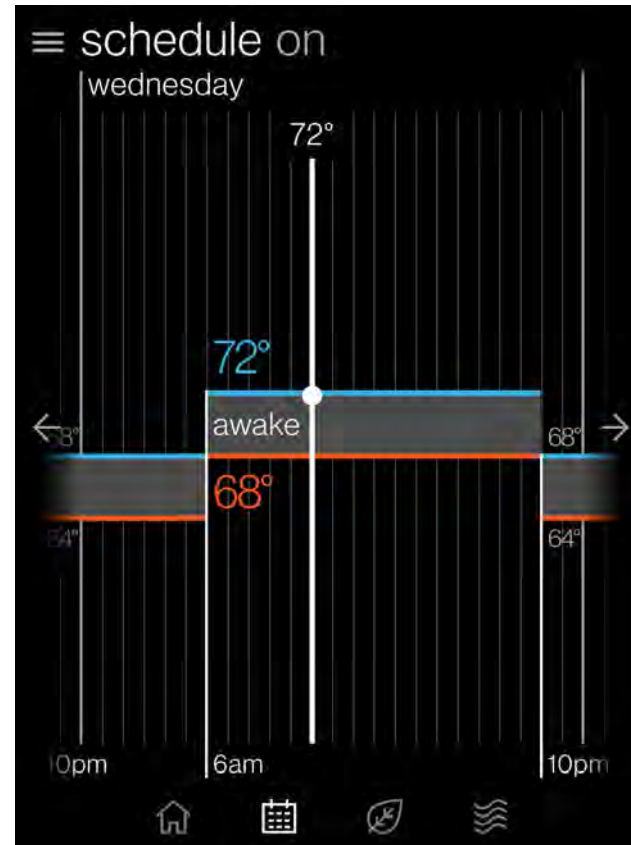

tuesday

awake
8:00 am

sleep
10:00 pm

copy day

to:

s m t w t f s

cancel paste

Homeowner Navigation

Away

- The away screen displays the current state (on/off) and the away cooling/heating setpoints used when away is on.
 - on/off is selected from drop down menu.
- User can change the values of the setpoints by dragging the numbers or the comfort range up and down.
- With the mobile application, enabling geo-fencing will automatically switch to away mode when outside the radius.
 - Settings must be configured in the mobile application.



Air quality

- The air quality screen displays indoor air quality levels, outdoor air quality, and weather (when connected to the internet and paired with the app.)
- If air quality sensors are not installed, indoor air quality is based on filter life cycle and humidity values.
- Selecting indoor air quality from the air quality screen allows you to access one clean and air quality history.
 - One clean runs the fan, at high speed for three hours, to circulate and filter the indoor air.

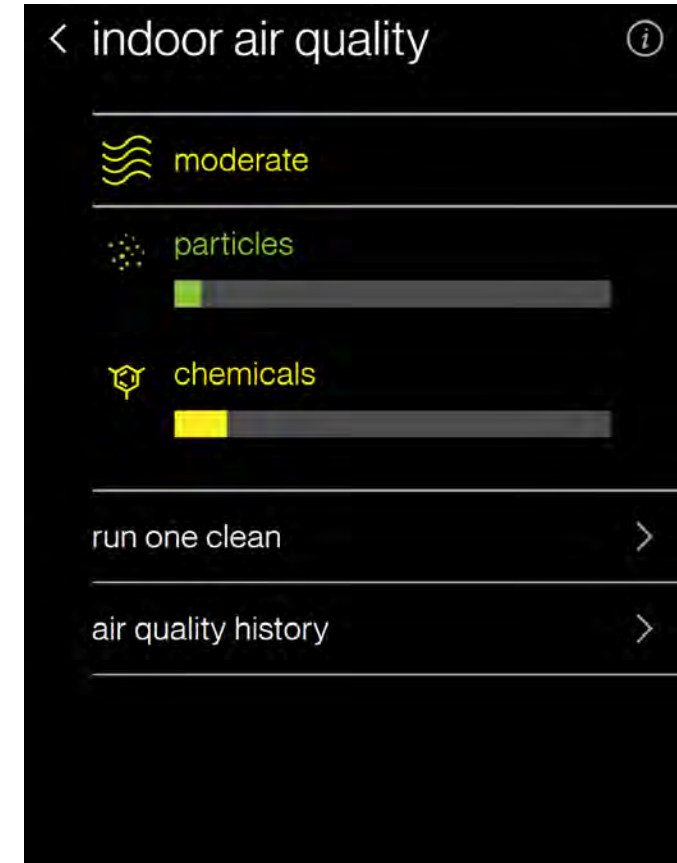
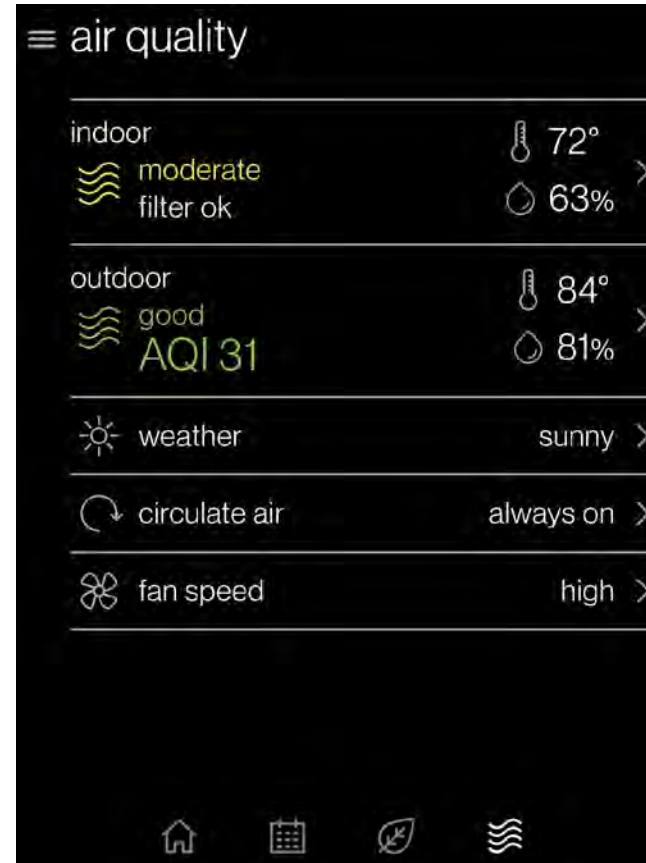

Settings

- Settings gives you access to additional supporting features:
 - Display.
 - Adjust and enable visual features.
 - Comfort.
 - Set target humidity.
 - Configuration.
 - App. account setup
 - Dealer information
 - Date & Time
 - Enable messages/view alerts
 - System components
 - Home Wi-Fi

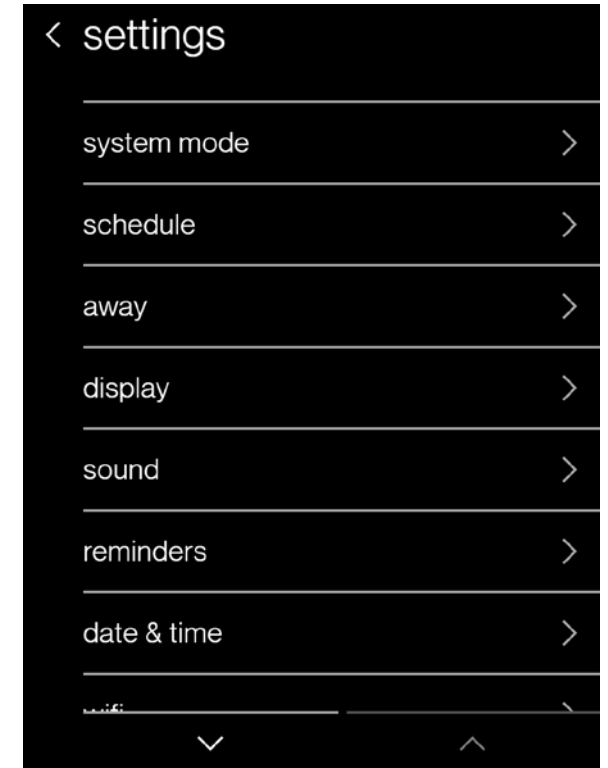
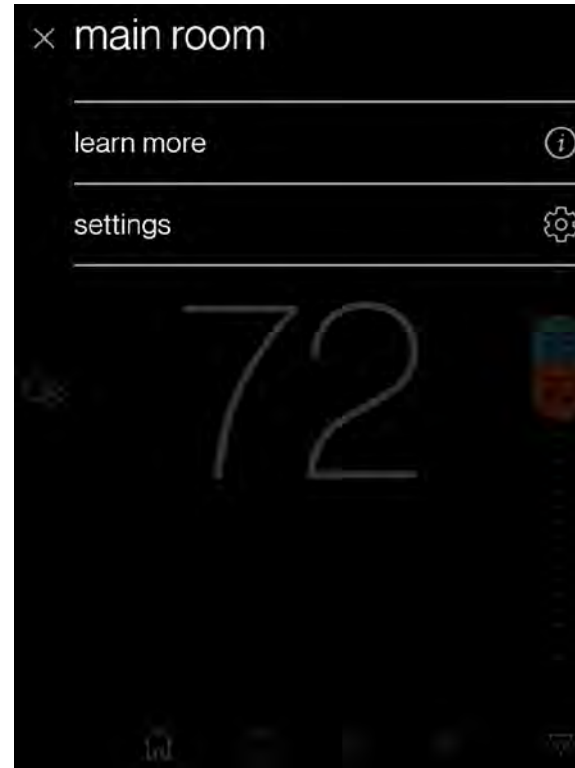

Agenda

Daikin One Touch

System Configurations

Installing Daikin One Touch

Commissioning Daikin One Touch

Full Set-up

Dealer Navigation

Homeowner Navigation

Mobile Apps

Account set-up

- Setting up an account is a four-step process.
 1. Downloading the application from your IOS or Android application store.
 - Creating the account.
 2. Confirming your account.
 3. Adding the thermostats' location.
 4. Connecting the app to the thermostat.

Note: A mobile device, the **Daikin One Touch** connected to **Wi-Fi** that is wired to a **communicating system** and a valid **email address** is needed to create a mobile account.

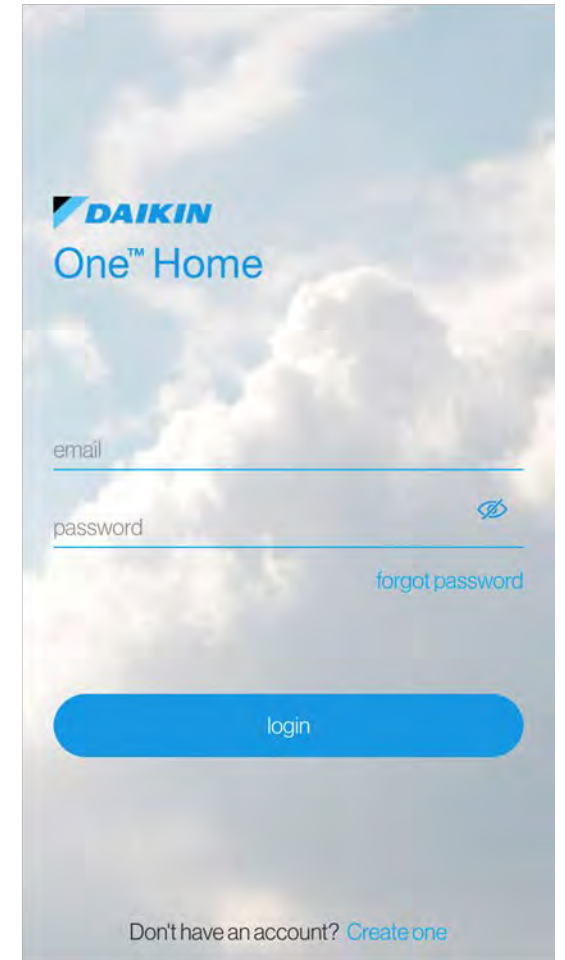
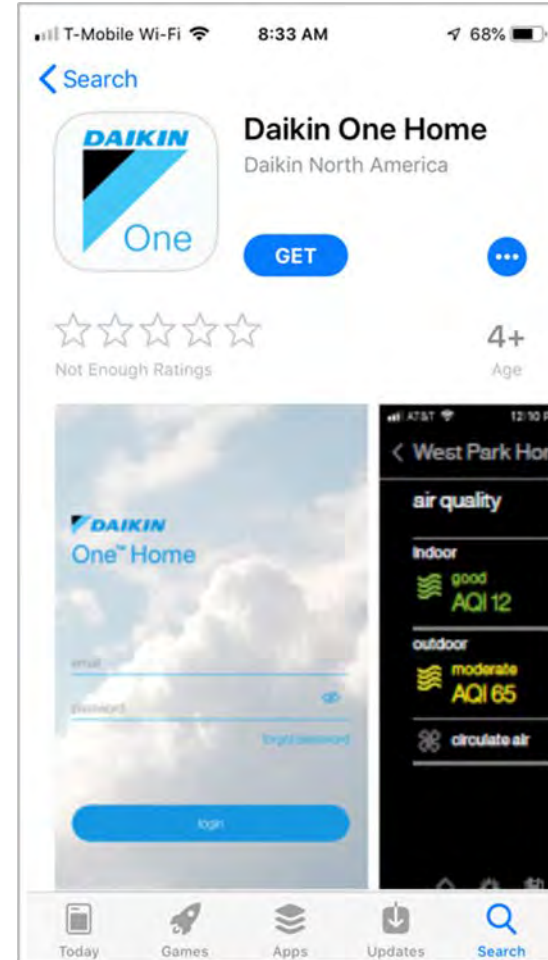

Step 1 - Create the account

- Tapping create one at the bottom right corner of the login screen will start the process.
- Before agreeing, read the terms and service, privacy statement, and other notices.
- Fill in your name, valid email address, and password.

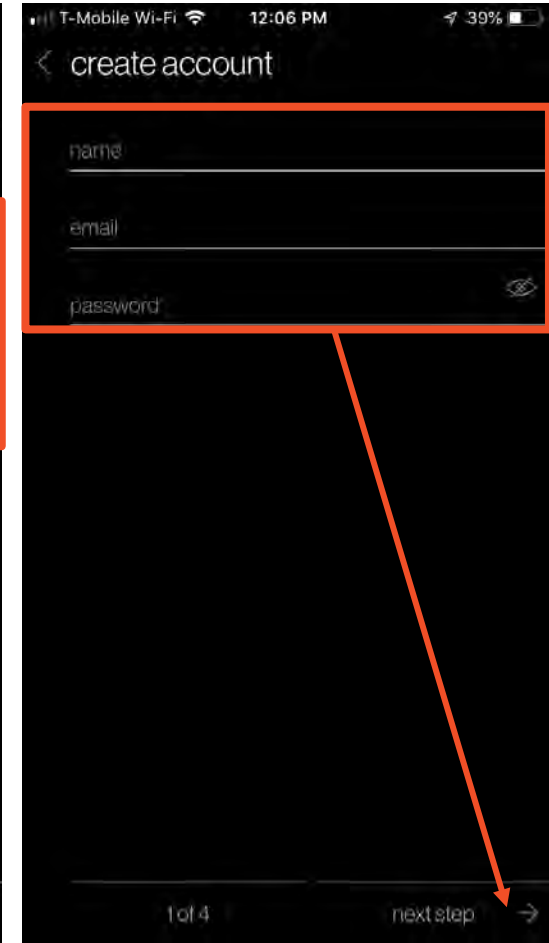
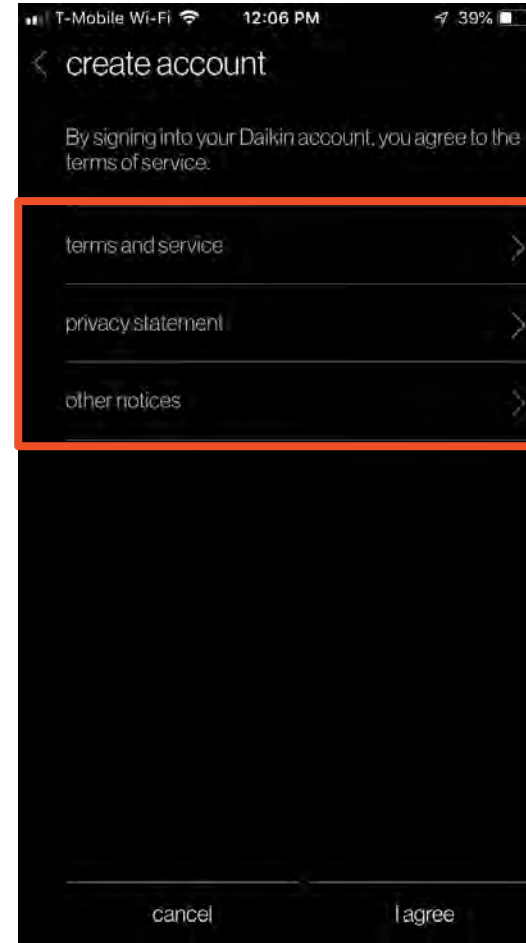
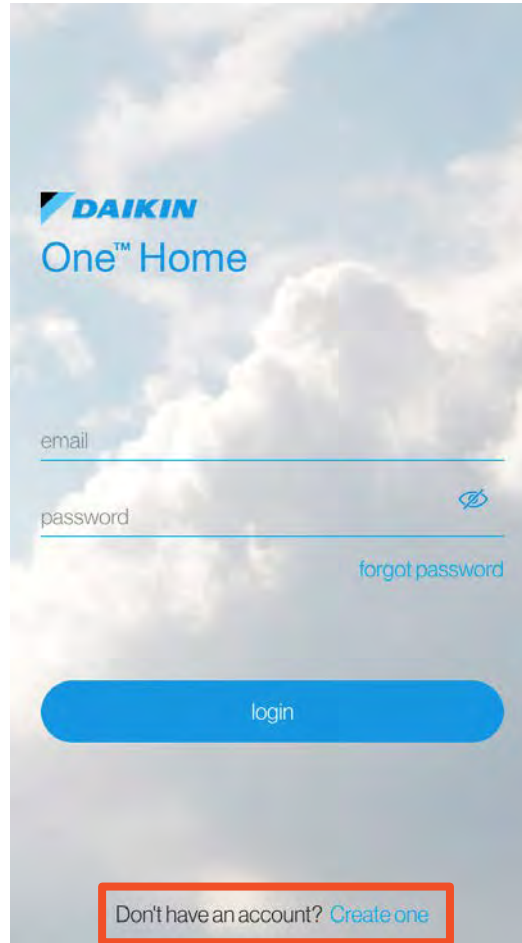

Step 2 - Confirming the account

- You will be prompted to access the email address you provided when creating the account.
- A welcome email will appear in your inbox providing a six-digit code.
- Entering the six-digit code on your phone app. will allow you to continue.

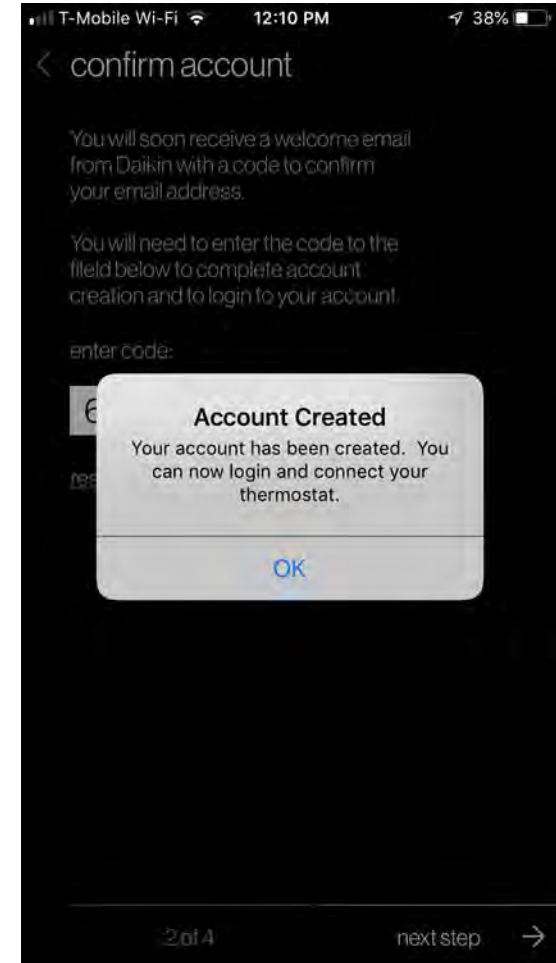
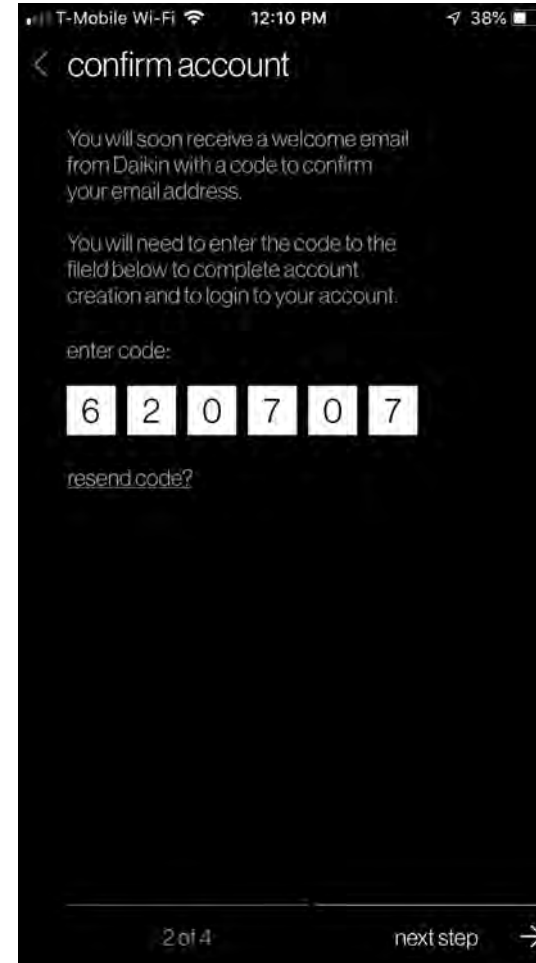
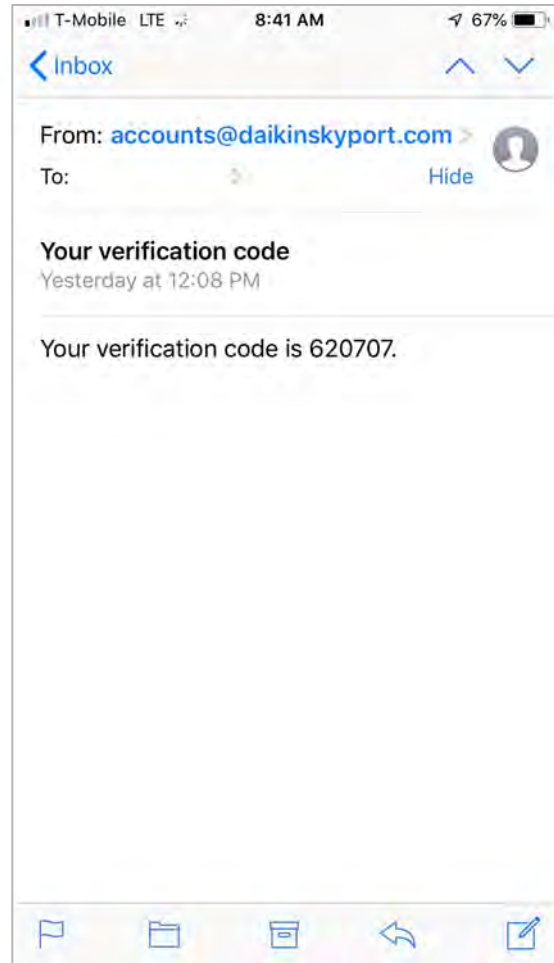

Step 3 - Adding the thermostats location

- Enter the email and password associated to your mobile account and tap the login button.
 - If you have forgotten your password, tap the forgot password link to recover information via email.
- Type the address of where the thermostat is located to gather accurate information.

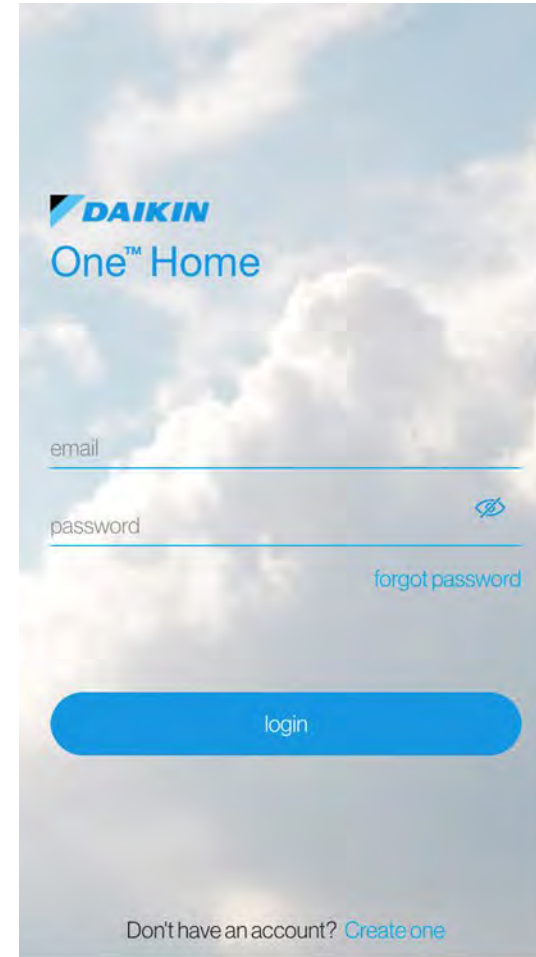

Step 4 - Connecting the App to the thermostat

- With Wi-Fi enabled on your thermostat, access your account to retrieve the six-digit code.
- Type the six-digit code displayed on your thermostat into the space provided on the mobile app.
- Tap connect to continue and operate the Daikin One Touch from your mobile device.

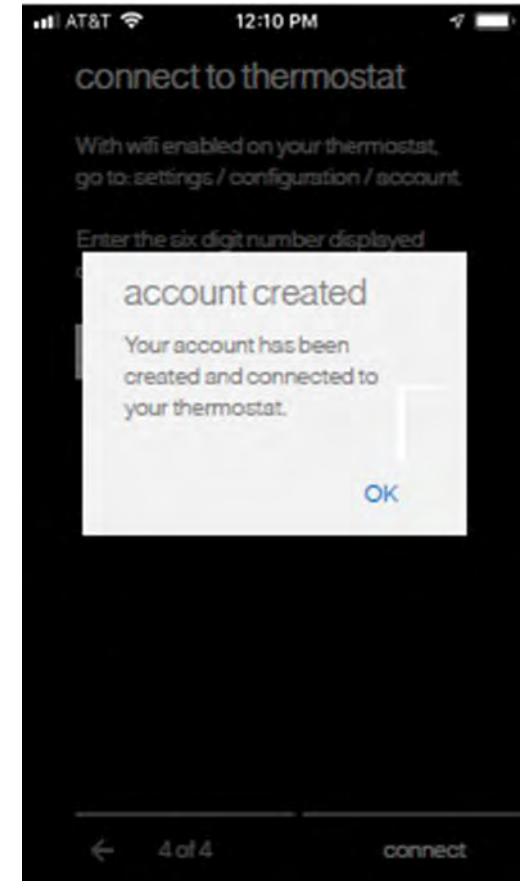
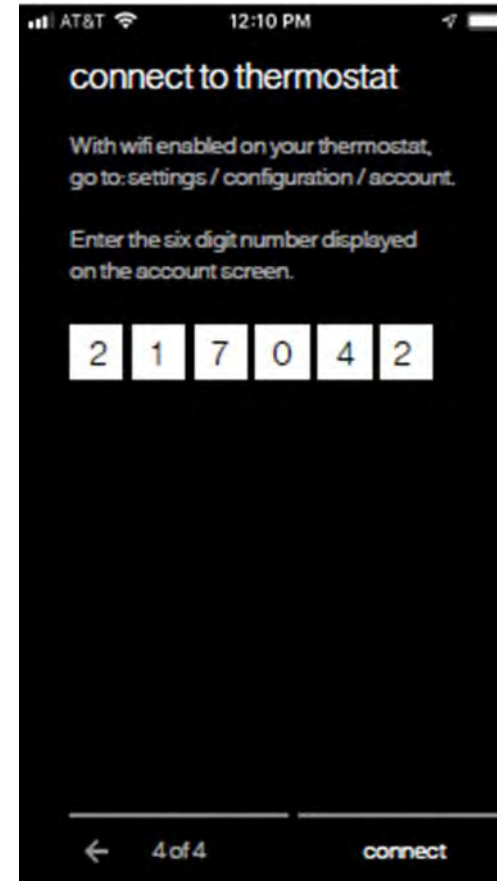
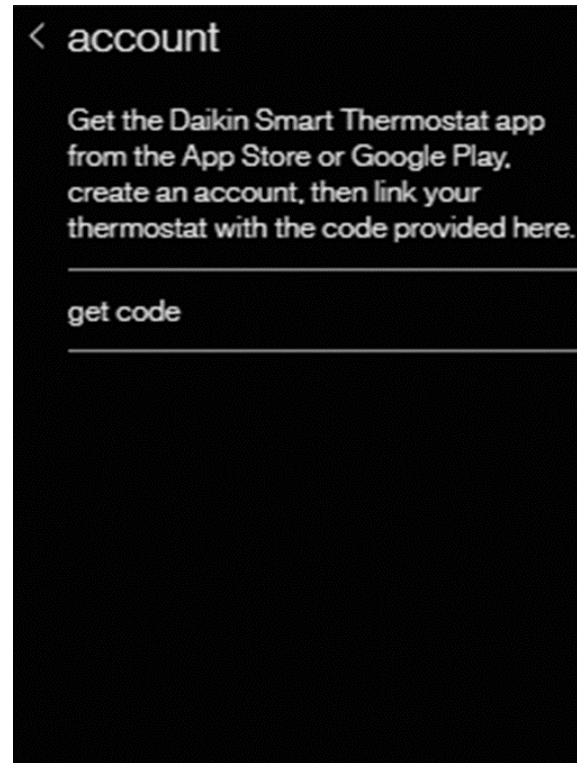

Mobile App.

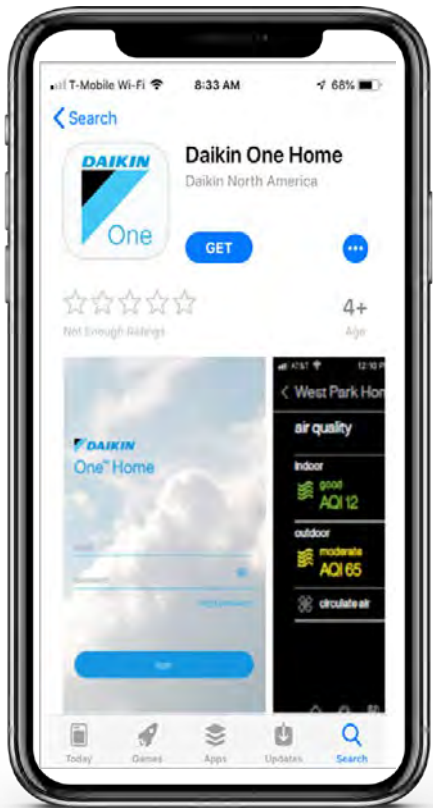

Visit <https://daikinone.com/professionals/resources> for additional information



