

SPLIT-SYSTEM HEAT PUMP UP TO 15.2 SEER2 & 7.8 HSPF2 1 ½ TO 5 TONS



■ Contents

Nomenclature.....	2
Product Specifications.....	3
Expanded Cooling Data.....	4
Expanded Heating Data.....	18
Performance Data.....	20
AHRI Ratings (see note).....	21
Dimensions.....	22
Wiring Diagrams.....	23
Accessories.....	26

■ Standard Features

- High-efficiency Copeland® scroll compressor
- Advanced Copeland® CoreSense™ technology
- Copper tube/enhanced aluminum fin coil - 5mm diameter on 1.5-3.5T
- High density foam compressor sound blanket
- Time-delay technology to ensure quiet reliable defrost
- Factory-installed bi-flow liquid line filter drier
- Factory-installed suction line accumulator
- Factory-installed compressor crank case heater
- Factory-installed high capacity muffler
- High- and low-pressure switches
- Service valves with sweat connections and easy access to gauge ports
- Copper tube/enhanced aluminum fin coil
- Fully charged for 15' of tubing length
- AHRI Certified; ETL Listed

■ Cabinet Features







- Removable grille-style top design compliant with UL 60335-2-40
- Custom Nickel Gray powder-paint finish
- 500-hour salt-spray tested
- Wire fan discharge grille
- Steel louver coil guard
- Rust-resistant screws
- Top and side maintenance access
- Single-panel access to controls with space provided for field-installed accessories
- When properly anchored, meets the 2020 Florida Building Code unit integrity requirements for hurricane-type winds (Anchor bracket kits available.)



Proper sizing and installation of equipment is critical to achieve optimal performance. Split system air conditioners and heat pumps must be matched with appropriate coil components to meet **ENERGY STAR®** criteria. Ask your contractor for details or visit www.energystar.gov.



* Complete warranty details available from your local dealer or at www.daikincomfort.com. To receive the 6-Year Unit Replacement Limited Warranty and 12-Year Parts Limited Warranty, online registration must be completed within 60 days of installation. Additional requirements for annual maintenance are required for the Unit Replacement Limited Warranty. Online registration and some of the additional requirements are not required in California or Quebec. The duration of warranty coverage in Texas and Florida differs in some cases.

	DZ5SEA 1810A*	DZ5SEA 2410A*	DZ5SEA 3010A*	DZ5SEA 3610A*	DZ5SEA 4210A*	DZ5SEA 4810A*	DZ5SEA 6010A*
NOMINAL CAPACITIES							
Cooling (BTU/h)	18,000	24,000	30,000	36,000	42,000	48,000	60,000
Heating (BTU/h)	18,000	24,000	30,000	36,000	42,000	48,000	60,000
Decibels	67	71	68	71	74	72	74
COMPRESSOR							
RLA	9.0	11.5	14.1	16.0	17.7	19.9	25.6
LRA	42.6	59.5	67.9	91.9	110.2	110.0	151.0
Stage	Single	Single	Single	Single	Single	Single	Two
Type	Scroll	Scroll	Scroll	Scroll	Scroll	Scroll	Scroll
CONDENSER FAN MOTOR							
Motor Type	PSC	PSC	PSC	ECM	PSC	PSC	PSC
Horsepower	1/6	1/6	1/6	1/3	1/4	1/4	1/5
FLA	0.95	0.97	0.97	2.8	1.3	1.3	1.0
REFRIGERATION SYSTEM							
Refrigerant Line Size ¹							
Liquid Line Size ("O.D.)	3/8"	3/8"	3/8"	3/8"	3/8"	3/8"	3/8"
Suction Line Size ("O.D.)	3/4"	3/4"	3/4"	7/8"	1 1/8"	1 1/8"	1 1/8"
Refrigerant Connection Size							
Liquid Valve Size ("O.D.)	3/8"	3/8"	3/8"	3/8"	3/8"	3/8"	3/8"
Suction Valve Size ("O.D.) ^{2, 3}	3/4"	3/4"	3/4"	7/8"	7/8"	7/8"	7/8"
Valve Connection Type	Sweat	Sweat	Sweat	Sweat	Sweat	Sweat	Sweat
Refrigerant Charge ⁴	106	118	119	114	167	222	276
ELECTRICAL DATA							
Voltage (60 Hz)	208/230	208/230	208/230	208/230	208/230	208/230	208/230
Minimum Circuit Ampacity ⁵	12.2	15.3	18.6	22.8	23.4	26.2	33.0
Max. Overcurrent Protection ⁶	20	25	30	35	40	45	50
Min / Max Volts	197/253	197/253	197/253	197/253	197/253	197/253	197/253
Electrical Conduit Size	1/2" or 3/4"	1/2" or 3/4"	1/2" or 3/4"	1/2" or 3/4"	1/2" or 3/4"	1/2" or 3/4"	1/2" or 3/4"
UNIT WEIGHTS							
Equipment Weight	171	193	215	222	264	272	309
Shipping Weight	186	213	235	242	284	292	329
ENERGY STAR® CERTIFIED							
							

¹ Line sizes denoted for 25' line sets, tested and rated in accordance with ARI Standard 210/240. For other line set lengths or sizes, refer to the Installation Instructions and/or the Long Line Set Applications guide.

² Installer will need to supply 3/4" to 3/8" adapters for suction line connections.

³ Installer will need to supply 7/8" to 1 1/8" adapters for suction line connections.

⁴ Unit is factory charged with refrigerant for 15' of 3/8" liquid line. System charge must be adjusted per the Final Charge Adjustment procedure found in the Installation Instructions.

⁵ Wire size should be determined in accordance with National Electrical Codes; extensive wire runs will require larger wire sizes.

⁶ Must use time-delay fuses or HACR-type circuit breakers of the same size as noted.

NOTES

- Always check the S&R plate for electrical data on the unit being installed.

ENERGY STAR NOTES

Proper sizing and installation of equipment is critical to achieving optimal performance. Split system air conditioners and heat pumps must be matched with appropriate coil components to meet ENERGY STAR criteria. Ask your contractor for details or visit www.energystar.gov. The www.energystar.gov website provides up-to-date system combinations certified to meet ENERGY STAR requirements.

COOLING DATA — DZ5SEA1810A* + AMST30BU1400A*

IDB		OUTDOOR AMBIENT TEMPERATURE												105°F												115°F											
		65°F						75°F						85°F						95°F						105°F						115°F					
		59	63	67	71	59	63	67	71	59	63	67	71	59	63	67	71	59	63	67	71	59	63	67	71	59	63	67	71	59	63	67	71				
70	AIRFLOW	MBh	17.9	18.2	18.7	-	17.8	18.0	18.6	-	17.3	17.6	18.1	-	16.5	16.7	17.3	-	15.5	15.8	16.3	-	15.5	15.8	16.3	-	14.6	14.9	15.4	-	14.6	14.9	15.4	-			
		S/T	0.62	0.54	0.41	-	0.63	0.55	0.41	-	0.65	0.57	0.44	-	1.00	0.59	0.46	-	1.00	0.62	0.48	-	1.00	0.62	0.48	-	1.00	0.67	0.53	-	1.00	0.67	0.53	-			
	ΔT	19	17	14	-	19	17	14	-	19	17	14	-	19	17	14	-	18	17	13	-	18	17	13	-	19	18	14	-	19	18	14	-				
	kW	0.99	0.99	0.98	-	1.10	1.09	1.09	-	1.22	1.22	1.21	-	1.35	1.35	1.35	-	1.50	1.50	1.49	-	1.50	1.50	1.49	-	1.50	1.50	1.49	-	1.67	1.67	1.67	-				
	Amps	3.8	3.8	3.8	-	4.3	4.3	4.3	-	4.8	4.8	4.8	-	5.4	5.4	5.4	-	6.1	6.1	6.1	-	6.1	6.1	6.1	-	6.9	6.9	6.9	-	6.9	6.9	6.9	-				
	Hi PR	232	233	234	-	268	269	271	-	306	307	309	-	348	349	350	-	392	393	395	-	392	393	395	-	439	440	442	-	439	440	442	-				
	Lo PR	124	125	128	-	131	133	136	-	138	139	142	-	143	145	148	-	149	150	153	-	149	150	153	-	156	157	160	-	156	157	160	-				
	MBh	18.1	18.4	18.9	-	18.0	18.2	18.8	-	17.5	17.8	18.3	-	16.7	17.0	17.5	-	15.7	16.0	16.5	-	15.7	16.0	16.5	-	14.8	15.1	15.6	-	14.8	15.1	15.6	-				
	S/T	0.67	0.60	0.46	-	0.68	0.60	0.47	-	0.71	0.63	0.49	-	1.00	0.65	0.51	-	1.00	0.67	0.53	-	1.00	0.67	0.53	-	1.00	0.72	0.59	-	1.00	0.72	0.59	-				
	ΔT	18	16	13	-	18	16	13	-	18	16	13	-	18	16	13	-	17	16	12	-	17	16	12	-	18	17	13	-	18	17	13	-				
kW	0.99	0.99	0.99	-	1.10	1.10	1.10	-	1.22	1.22	1.22	-	1.36	1.36	1.36	-	1.51	1.51	1.50	-	1.51	1.51	1.50	-	1.68	1.68	1.67	-	1.68	1.68	1.67	-					
Amps	3.8	3.8	3.8	-	4.3	4.3	4.3	-	4.9	4.9	4.9	-	5.5	5.5	5.5	-	6.1	6.1	6.1	-	6.1	6.1	6.1	-	6.9	6.9	6.9	-	6.9	6.9	6.9	-					
Hi PR	233	234	236	-	270	271	273	-	308	309	311	-	349	350	352	-	394	395	396	-	394	395	396	-	441	442	444	-	441	442	444	-					
Lo PR	125	127	130	-	133	134	137	-	139	141	144	-	145	146	150	-	150	152	155	-	150	152	155	-	157	159	162	-	157	159	162	-					
MBh	18.3	18.6	19.1	-	18.2	18.4	19.0	-	17.7	18.0	18.5	-	16.9	17.2	17.7	-	15.9	16.2	16.7	-	15.9	16.2	16.7	-	15.0	15.3	15.8	-	15.0	15.3	15.8	-					
S/T	0.70	0.62	0.49	-	0.71	0.63	0.49	-	0.73	0.66	0.52	-	1.00	0.67	0.54	-	1.00	0.70	0.56	-	1.00	0.70	0.56	-	1.00	0.75	0.61	-	1.00	0.75	0.61	-					
ΔT	17	15	12	-	17	15	12	-	17	16	12	-	17	15	12	-	17	15	12	-	17	15	12	-	18	16	13	-	18	16	13	-					
kW	0.99	0.99	0.99	-	1.10	1.10	1.10	-	1.23	1.23	1.22	-	1.36	1.36	1.36	-	1.51	1.51	1.50	-	1.51	1.51	1.50	-	1.68	1.68	1.68	-	1.68	1.68	1.68	-					
Amps	3.8	3.8	3.8	-	4.3	4.3	4.3	-	4.9	4.9	4.9	-	5.5	5.5	5.5	-	6.2	6.2	6.2	-	6.2	6.2	6.2	-	7.0	7.0	6.9	-	7.0	7.0	6.9	-					
Hi PR	235	236	237	-	271	272	274	-	310	311	312	-	351	352	353	-	395	396	398	-	395	396	398	-	443	444	445	-	443	444	445	-					
Lo PR	127	128	131	-	134	136	139	-	141	142	145	-	146	148	151	-	152	153	156	-	152	153	156	-	159	160	163	-	159	160	163	-					
75	AIRFLOW	MBh	17.9	18.2	18.7	19.5	17.8	18.0	18.6	19.4	17.3	17.6	18.1	18.9	16.5	16.8	17.3	18.1	15.5	15.8	16.3	17.1	15.5	15.8	16.3	17.1	14.6	14.9	15.4	16.2	14.6	14.9	15.4	16.2			
		S/T	0.75	0.67	0.54	0.39	0.76	0.68	0.54	0.40	1.00	0.71	0.57	0.42	1.00	0.73	0.59	0.44	1.00	0.75	0.61	0.47	1.00	0.75	0.61	0.47	1.00	1.00	0.66	0.52	1.00	1.00	0.66	0.52			
	ΔT	22	21	17	14	22	21	17	14	23	21	18	14	22	21	17	14	22	20	17	14	22	20	17	14	23	21	18	15	23	21	18	15				
	kW	0.99	0.98	0.98	0.99	1.09	1.09	1.09	1.10	1.22	1.22	1.21	1.22	1.35	1.35	1.35	1.35	1.50	1.50	1.49	1.50	1.50	1.50	1.49	1.50	1.67	1.67	1.67	1.68	1.67	1.67	1.67	1.68				
	Amps	3.8	3.8	3.8	3.8	4.3	4.3	4.3	4.3	4.8	4.8	4.8	4.9	5.4	5.4	5.4	5.4	6.1	6.1	6.1	6.1	6.1	6.1	6.1	6.1	6.9	6.9	6.9	6.9	6.9	6.9	6.9	6.9				
	Hi PR	232	233	234	239	268	269	271	275	307	308	309	313	348	349	350	355	392	393	395	399	392	393	395	399	440	441	442	446	440	441	442	446				
	Lo PR	124	125	128	134	131	133	136	141	138	139	142	148	143	145	148	153	149	150	153	159	149	150	153	159	156	157	160	165	156	157	160	165				
	MBh	18.2	18.4	18.9	19.8	18.0	18.2	18.8	19.6	17.5	17.8	18.3	19.1	16.7	17.0	17.5	18.3	15.7	16.0	16.5	17.3	15.7	16.0	16.5	17.3	14.8	15.1	15.6	16.4	14.8	15.1	15.6	16.4				
	S/T	0.80	0.73	0.59	0.45	0.81	0.73	0.60	0.45	1.00	0.76	0.62	0.48	1.00	0.78	0.64	0.50	1.00	0.80	0.66	0.52	1.00	0.80	0.66	0.52	1.00	1.00	0.72	0.57	1.00	1.00	0.72	0.57				
	ΔT	21	20	17	13	21	20	16	13	22	20	17	13	21	20	16	13	21	19	16	13	21	19	16	13	22	21	17	14	22	21	17	14				
kW	0.99	0.99	0.99	1.00	1.10	1.10	1.10	1.11	1.22	1.22	1.22	1.23	1.35	1.35	1.35	1.36	1.50	1.50	1.50	1.51	1.50	1.50	1.50	1.51	1.68	1.67	1.67	1.68	1.68	1.67	1.67	1.68					
Amps	3.8	3.8	3.8	3.8	4.3	4.3	4.3	4.3	4.9	4.9	4.9	4.9	5.5	5.5	5.5	5.5	6.1	6.1	6.1	6.1	6.1	6.1	6.1	6.1	6.9	6.9	6.9	7.0	6.9	6.9	6.9	7.0					
Hi PR	234	235	236	240	270	271	273	277	308	309	311	315	350	351	352	356	394	395	397	401	394	395	397	401	441	442	444	448	441	442	444	448					
Lo PR	125	127	130	135	133	134	137	143	139	141	144	149	145	146	150	155	150	152	155	160	150	152	155	160	157	159	162	167	157	159	162	167					
MBh	18.3	18.6	19.1	20.0	18.2	18.4	19.0	19.8	17.7	18.0	18.5	19.3	16.9	17.2	17.7	18.5	15.9	16.2	16.7	17.5	15.9	16.2	16.7	17.5	15.0	15.3	15.8	16.6	15.0	15.3	15.8	16.6					
S/T	0.83	0.75	0.62	0.47	1.00	0.76	0.62	0.48	1.00	0.79	0.65	0.50	1.00	0.81	0.67	0.52	1.00	0.83	0.69	0.55	1.00	0.83	0.69	0.55	1.00	1.00	0.74	0.60	1.00	1.00	0.74	0.60					
ΔT	21	19	16	13	21	19	16	12	21	19	16	13	21	19	16	12	21	19	16	12	21	19	16	12	22	20	17	13	22	20	17	13					
kW	0.99	0.99	0.99	1.00	1.10	1.10	1.10	1.11	1.23	1.22	1.22	1.23	1.36	1.36	1.35	1.36	1.51	1.50	1.50	1.51	1.51	1.50	1.50	1.51	1.68	1.68	1.68	1.68	1.68	1.68	1.68	1.68					
Amps	3.8	3.8	3.8	3.8	4.3	4.3	4.3	4.3	4.9	4.9	4.9	4.9	5.5	5.5	5.5	5.5	6.2	6.2	6.2	6.2	6.2	6.2	6.2	6.2	7.0	6.9	6.9	7.0	7.0	6.9	6.9	7.0					
Hi PR	235	236	238	242	272	273	274	278	310	311	312	316	351	352	354	358	395	396	398	402	395	396	398	402	443	444	445	449	443	444	445	449					
Lo PR	127	128	131	137	134	136	139	144	141	142	145	151	146	148	151	156	152	153	156	162	152	153	156	162	159	160	163	169	159	160	163	169					

IDB: Entering Indoor Dry Bulb Temperature
 High and low pressures are measured at the liquid and suction service valves.
 Shaded area reflects ACCA (TVA) Rating Conditions.
 kW = Total system power
 Amps = Outdoor unit amps (compressor + fan)

COOLING DATA — DZ5SEA1810A* + AMST30BU1400A* (CONT.)

IDB	AIRFLOW	OUTDOOR AMBIENT TEMPERATURE																							
		65°F				75°F				85°F				95°F				105°F				115°F			
		59	63	67	71	59	63	67	71	59	63	67	71	59	63	67	71	59	63	67	71	59	63	67	71
80	MBh	18.0	18.3	18.8	19.6	17.9	18.1	18.7	19.5	17.4	17.7	18.2	19.0	16.6	16.9	17.4	18.2	15.6	15.9	16.4	17.2	14.7	15.0	15.5	16.3
	S/T	1.00	0.80	0.66	0.52	1.00	0.81	0.67	0.53	1.00	0.83	0.70	0.55	1.00	1.00	0.71	0.57	1.00	1.00	0.74	0.59	1.00	1.00	0.79	0.64
	ΔT	26	25	21	18	26	24	21	18	26	24	21	18	26	24	21	18	26	24	21	18	27	25	22	19
	kW	0.99	0.99	0.98	0.99	1.10	1.09	1.09	1.10	1.22	1.22	1.21	1.22	1.35	1.35	1.35	1.36	1.50	1.50	1.49	1.50	1.67	1.67	1.67	1.68
	Amps	3.8	3.8	3.8	3.8	4.3	4.3	4.3	4.3	4.8	4.8	4.8	4.9	5.4	5.4	5.4	5.5	6.1	6.1	6.1	6.2	6.9	6.9	6.9	6.9
	Hi PR	232	233	235	239	269	270	271	275	307	308	310	314	348	349	351	355	393	394	395	399	440	441	443	447
	Lo PR	124	126	129	134	132	133	136	142	138	140	143	148	144	145	148	154	149	151	154	159	156	158	161	166
	MBh	18.2	18.5	19.0	19.8	18.1	18.3	18.9	19.7	17.6	17.9	18.4	19.2	16.8	17.1	17.6	18.4	15.8	16.1	16.6	17.4	14.9	15.2	15.7	16.5
	S/T	1.00	0.85	0.72	0.57	1.00	0.86	0.72	0.58	1.00	0.89	0.75	0.60	1.00	1.00	0.77	0.62	1.00	1.00	0.79	0.65	1.00	1.00	0.84	0.70
	ΔT	25	24	20	17	25	24	20	17	26	24	21	17	25	24	20	17	25	23	20	17	26	24	21	18
kW	0.99	0.99	0.99	1.00	1.10	1.10	1.10	1.11	1.22	1.22	1.22	1.23	1.35	1.35	1.35	1.36	1.50	1.50	1.50	1.51	1.68	1.67	1.67	1.68	
Amps	3.8	3.8	3.8	3.8	4.3	4.3	4.3	4.3	4.9	4.9	4.9	4.9	5.5	5.5	5.5	5.5	6.1	6.1	6.1	6.2	6.9	6.9	6.9	7.0	
Hi PR	234	235	237	241	271	272	273	277	309	310	311	316	350	351	353	357	394	395	397	401	442	443	445	449	
Lo PR	126	127	130	136	133	135	138	143	140	141	145	150	145	147	150	155	151	152	156	161	158	159	162	168	
MBh	18.4	18.7	19.2	20.0	18.3	18.5	19.1	19.9	17.8	18.1	18.6	19.4	17.0	17.3	17.8	18.6	16.0	16.3	16.8	17.6	15.1	15.4	15.9	16.7	
S/T	1.00	0.88	0.74	0.60	1.00	0.89	0.75	0.61	1.00	0.91	0.78	0.63	1.00	1.00	0.80	0.65	1.00	1.00	0.82	0.67	1.00	1.00	0.87	0.72	
ΔT	25	23	20	16	25	23	20	16	25	23	20	17	25	23	20	16	24	23	19	16	25	24	21	17	
kW	0.99	0.99	0.99	1.00	1.10	1.10	1.10	1.11	1.23	1.23	1.22	1.23	1.36	1.36	1.36	1.36	1.51	1.50	1.50	1.51	1.68	1.68	1.68	1.68	
Amps	3.8	3.8	3.8	3.8	4.3	4.3	4.3	4.3	4.9	4.9	4.9	4.9	5.5	5.5	5.5	5.5	6.2	6.2	6.2	6.2	7.0	7.0	6.9	7.0	
Hi PR	235	236	238	242	272	273	275	279	310	311	313	317	351	352	354	358	396	397	398	402	443	444	446	450	
Lo PR	127	129	132	137	135	136	139	145	141	143	146	151	147	148	152	157	152	154	157	162	159	161	164	169	

85	MBh	18.3	18.6	19.1	19.9	18.2	18.4	19.0	19.8	17.7	18.0	18.5	19.3	16.9	17.2	17.7	18.5	15.9	16.2	16.7	17.5	15.0	15.3	15.8	16.6
	S/T	1.00	0.90	0.77	0.6	1.00	0.91	0.77	0.6	1.00	1.00	0.80	0.7	1.00	1.00	0.82	0.7	1.00	1.00	0.84	0.7	1.00	1.00	1.00	0.7
	ΔT	30	28	25	21	30	28	25	21	30	28	25	22	30	28	25	21	29	28	24	21	30	29	25	22
	kW	0.99	0.99	0.99	1.0	1.10	1.10	1.09	1.1	1.22	1.22	1.22	1.2	1.35	1.35	1.35	1.4	1.50	1.50	1.50	1.5	1.67	1.67	1.67	1.7
	Amps	3.8	3.8	3.8	3.8	4.3	4.3	4.3	4.3	4.9	4.8	4.8	4.9	5.5	5.5	5.5	5.5	6.1	6.1	6.1	6.2	6.9	6.9	6.9	7.0
	Hi PR	233	234	236	240	270	271	273	277	308	309	311	315	349	350	352	356	394	395	396	400	441	442	444	448
	Lo PR	126	128	131	136	134	135	138	143	140	142	145	150	146	147	150	156	151	153	156	161	158	159	163	168
	MBh	18.5	18.8	19.3	20.2	18.4	18.6	19.2	20.0	17.9	18.2	18.7	19.5	17.1	17.4	17.9	18.7	16.1	16.4	16.9	17.7	15.2	15.5	16.0	16.8
	S/T	1.00	0.96	0.82	0.7	1.00	1.00	0.83	0.7	1.00	1.00	0.85	0.7	1.00	1.00	0.87	0.7	1.00	1.00	0.89	0.7	1.00	1.00	1.00	0.8
	ΔT	29	27	24	20	29	27	24	20	29	27	24	21	29	27	24	20	28	27	23	20	30	28	25	21
kW	0.99	0.99	0.99	1.0	1.10	1.10	1.10	1.1	1.22	1.22	1.22	1.2	1.36	1.36	1.36	1.4	1.50	1.50	1.50	1.5	1.68	1.68	1.68	1.7	
Amps	3.8	3.8	3.8	3.8	4.3	4.3	4.3	4.3	4.9	4.9	4.9	4.9	5.5	5.5	5.5	5.5	6.2	6.2	6.1	6.2	7.0	6.9	6.9	7.0	
Hi PR	235	236	238	242	272	273	274	278	310	311	313	317	351	352	354	358	396	397	398	402	443	444	446	450	
Lo PR	128	129	132	138	135	137	140	145	142	143	146	152	147	149	152	157	153	154	157	163	160	161	164	170	
MBh	18.7	19.0	19.5	20.3	18.6	18.8	19.4	20.2	18.1	18.4	18.9	19.7	17.3	17.6	18.1	18.9	16.3	16.6	17.1	17.9	15.4	15.7	16.2	17.0	
S/T	1.00	0.98	0.85	0.7	1.00	1.00	0.85	0.7	1.00	1.00	0.88	0.7	1.00	1.00	0.90	0.8	1.00	1.00	1.00	0.8	1.00	1.00	1.00	0.8	
ΔT	28	26	23	20	28	26	23	20	28	27	23	20	28	26	23	20	28	26	23	19	29	27	24	21	
kW	1.00	1.00	0.99	1.0	1.11	1.11	1.10	1.1	1.23	1.23	1.23	1.2	1.36	1.36	1.36	1.4	1.51	1.51	1.51	1.5	1.68	1.68	1.68	1.7	
Amps	3.8	3.8	3.8	3.9	4.3	4.3	4.3	4.4	4.9	4.9	4.9	4.9	5.5	5.5	5.5	5.5	6.2	6.2	6.2	6.2	7.0	7.0	7.0	7.0	
Hi PR	237	238	239	243	273	274	276	280	311	312	314	318	352	354	355	359	397	398	400	404	444	445	447	451	
Lo PR	129	131	134	139	137	138	141	146	143	145	148	153	149	150	153	159	154	156	159	164	161	163	166	171	

IDB: Entering Indoor Dry Bulb Temperature
 High and low pressures are measured at the liquid and suction service valves.
 Shaded area reflects AHRI Rating Conditions.
 kW = Total system power
 Amps = Outdoor unit amps (compressor + fan)

COOLING DATA — DZ5SEA2410A* + AMST30BU1400A* (CONT.)

IDB		OUTDOOR AMBIENT TEMPERATURE												115°F																																																																																																																																																																								
		65°F						75°F						85°F						95°F						105°F																																																																																																																																																												
		59	63	67	71	75	79	59	63	67	71	75	79	59	63	67	71	75	79	59	63	67	71	75	79	59	63	67	71	75	79																																																																																																																																																							
700		MBh	23.7	24.1	24.8	25.9	23.5	23.9	24.6	25.6	22.9	23.2	24.0	25.0	21.9	22.2	22.9	24.0	20.6	20.9	21.6	22.7	19.4	19.7	20.4	21.5	S/T	1.00	0.79	0.66	0.51	1.00	0.80	0.66	0.52	1.00	0.82	0.69	0.54	1.00	0.84	0.71	0.56	1.00	1.00	1.00	0.73	0.58	1.00	1.00	0.78	0.64	ΔT	29	27	23	20	28	27	23	19	29	27	23	20	28	27	23	19	28	26	26	23	19	29	28	24	20	kW	1.29	1.29	1.29	1.30	1.44	1.44	1.44	1.45	1.60	1.60	1.60	1.61	1.78	1.78	1.77	1.79	1.97	1.97	1.97	1.97	1.98	2.20	2.20	2.20	2.21	Amps	5.0	5.0	5.0	5.0	5.6	5.6	5.6	5.7	6.4	6.4	6.4	6.4	7.2	7.2	7.2	7.2	8.1	8.1	8.1	8.1	8.1	9.1	9.1	9.1	9.2	Hi PR	235	236	238	242	272	273	275	279	311	312	313	317	352	353	355	359	397	398	400	400	404	445	446	448	452	Lo PR	124	125	128	134	131	133	136	141	138	139	143	148	143	145	148	153	149	150	154	154	159	156	157	160	166
800		MBh	24.0	24.4	25.1	26.2	23.8	24.2	24.9	26.0	23.2	23.6	24.3	25.3	22.2	22.5	23.2	24.3	20.9	21.2	21.9	23.0	19.7	20.0	20.7	21.8	S/T	1.00	0.85	0.72	0.57	1.00	0.86	0.72	0.58	1.00	0.88	0.75	0.60	1.00	1.00	1.00	0.77	1.00	1.00	1.00	0.79	0.65	1.00	1.00	0.84	0.70	ΔT	27	26	22	18	27	25	22	18	28	26	22	19	27	25	22	18	27	25	22	22	18	28	26	23	19	kW	1.30	1.30	1.30	1.31	1.45	1.45	1.44	1.45	1.61	1.61	1.61	1.62	1.79	1.78	1.78	1.79	1.98	1.98	1.98	1.98	1.99	2.21	2.21	2.21	2.22	Amps	5.0	5.0	5.0	5.0	5.7	5.7	5.7	5.7	6.4	6.4	6.4	6.5	7.2	7.2	7.2	7.3	8.1	8.1	8.1	8.1	8.2	9.2	9.2	9.2	9.2	Hi PR	237	238	240	244	274	275	277	281	313	314	315	319	354	355	357	361	399	400	402	402	406	447	448	450	454	Lo PR	126	127	130	136	133	135	138	143	140	141	144	150	145	147	150	155	151	152	155	155	161	158	159	162	167
900		MBh	24.4	24.8	25.5	26.5	24.2	24.5	25.2	26.3	23.6	23.9	24.6	25.7	22.5	22.9	23.6	24.6	21.2	21.6	22.3	23.4	20.1	20.4	21.1	22.2	S/T	1.00	0.89	0.75	0.61	1.00	0.89	0.76	0.61	1.00	0.92	0.78	0.64	1.00	1.00	1.00	0.80	1.00	1.00	1.00	0.82	0.68	1.00	1.00	0.88	0.73	ΔT	26	25	21	17	26	25	21	17	27	25	21	18	26	25	21	17	26	24	21	21	17	27	25	22	18	kW	1.31	1.31	1.30	1.32	1.45	1.45	1.45	1.46	1.62	1.61	1.61	1.62	1.79	1.79	1.79	1.80	1.99	1.99	1.99	1.98	2.00	2.22	2.22	2.22	2.23	Amps	5.0	5.0	5.0	5.1	5.7	5.7	5.7	5.7	6.5	6.4	6.4	6.5	7.3	7.3	7.2	7.3	8.2	8.2	8.2	8.1	8.2	9.2	9.2	9.2	9.2	Hi PR	239	240	242	246	276	277	279	283	315	316	317	321	356	357	359	363	401	402	404	404	408	449	450	452	456	Lo PR	128	129	132	138	135	137	140	145	142	143	146	152	147	149	152	157	153	154	154	157	163	160	161	164	169

IDB		OUTDOOR AMBIENT TEMPERATURE												115°F																																																																																																																																																																								
		65°F						75°F						85°F						95°F						105°F																																																																																																																																																												
		59	63	67	71	75	79	59	63	67	71	75	79	59	63	67	71	75	79	59	63	67	71	75	79	59	63	67	71	75	79																																																																																																																																																							
700		MBh	24.1	24.5	25.2	26.3	23.9	24.3	25.0	26.0	23.3	23.6	24.3	25.4	22.2	22.6	23.3	24.4	21.0	21.3	22.0	23.1	19.8	20.1	20.8	21.9	S/T	1.00	0.89	0.76	0.6	1.00	0.90	0.76	0.6	1.00	1.00	0.85	0.7	1.00	1.00	1.00	0.81	0.7	1.00	1.00	0.83	0.7	1.00	1.00	1.00	0.7	ΔT	32	30	27	23	32	30	27	23	32	31	27	23	32	30	27	23	32	30	27	23	33	31	28	24	kW	1.30	1.30	1.29	1.3	1.44	1.44	1.44	1.4	1.60	1.60	1.60	1.6	1.78	1.78	1.78	1.8	1.98	1.98	1.97	1.97	2.0	2.21	2.21	2.20	2.2	Amps	5.0	5.0	5.0	5.0	5.7	5.7	5.6	5.7	6.4	6.4	6.4	6.4	7.2	7.2	7.2	7.2	8.1	8.1	8.1	8.1	8.1	9.2	9.2	9.1	9.2	Hi PR	236	237	239	243	273	274	276	280	312	313	314	319	353	354	356	360	398	399	401	401	405	446	447	449	453	Lo PR	126	127	130	136	133	135	138	143	140	141	144	150	145	147	150	155	151	152	155	155	161	158	159	162	167	
800		MBh	24.4	24.8	25.5	26.6	24.2	24.6	25.3	26.4	23.6	24.0	24.7	25.7	22.6	22.9	23.6	24.7	21.3	21.6	22.3	23.4	20.1	20.4	21.1	22.2	S/T	1.00	0.96	0.82	0.7	1.00	1.00	0.82	0.7	1.00	1.00	0.85	0.7	1.00	1.00	1.00	0.87	0.7	1.00	1.00	0.89	0.7	1.00	1.00	1.00	0.8	ΔT	31	29	26	22	31	29	26	22	31	29	26	22	31	29	26	22	31	29	25	25	22	32	30	27	23	kW	1.30	1.30	1.30	1.3	1.45	1.45	1.45	1.5	1.61	1.61	1.61	1.6	1.79	1.79	1.78	1.8	1.98	1.98	1.98	1.98	2.0	2.22	2.21	2.21	2.2	Amps	5.0	5.0	5.0	5.1	5.7	5.7	5.7	5.7	6.4	6.4	6.4	6.5	7.2	7.2	7.2	7.3	8.1	8.1	8.1	8.1	8.2	9.2	9.2	9.2	9.2	Hi PR	238	239	241	245	275	276	278	282	314	315	316	320	355	356	358	362	400	401	403	403	407	448	449	451	455	Lo PR	127	129	132	137	135	137	140	145	142	143	146	151	147	149	152	157	153	154	157	157	162	159	161	164	169
900		MBh	24.8	25.2	25.9	26.9	24.6	24.9	25.6	26.7	24.0	24.3	25.0	26.1	22.9	23.3	24.0	25.0	21.6	22.0	22.7	23.8	20.5	20.8	21.5	22.6	S/T	1.00	0.99	0.85	0.7	1.00	1.00	0.86	0.7	1.00	1.00	0.88	0.7	1.00	1.00	1.00	0.90	0.8	1.00	1.00	1.00	0.8	1.00	1.00	1.00	0.8	ΔT	30	28	25	21	30	28	25	21	30	28	25	21	30	28	25	21	30	28	24	24	21	31	29	26	22	kW	1.31	1.31	1.31	1.3	1.46	1.46	1.45	1.5	1.62	1.62	1.62	1.6	1.79	1.79	1.79	1.8	1.99	1.99	1.99	1.99	2.0	2.22	2.22	2.22	2.2	Amps	5.1	5.1	5.0	5.1	5.7	5.7	5.7	5.8	6.5	6.5	6.4	6.5	7.3	7.3	7.3	7.3	8.2	8.2	8.2	8.2	8.2	9.2	9.2	9.2	9.3	Hi PR	240	241	243	247	277	278	280	284	316	317	318	322	357	358	360	364	402	403	405	405	409	450	451	453	457	Lo PR	129	131	134	139	137	139	142	147	144	145	148	153	149	151	154	159	155	156	159	159	164	161	163	166	171

IDB: Entering Indoor Dry Bulb Temperature
 High and low pressures are measured at the liquid and suction service valves.
 Shaded area reflects AHRI Rating Conditions.
 kW = Total system power
 Amps = Outdoor unit amps (compressor + fan)

COOLING DATA — DZ5SEA3010A* + AMST30BU1400A*

IDB		OUTDOOR AMBIENT TEMPERATURE																																																
		65°F								75°F								85°F								95°F								105°F								115°F								
		59	63	67	71	59	63	67	71	59	63	67	71	59	63	67	71	59	63	67	71	59	63	67	71	59	63	67	71	59	63	67	71																	
70	875	AIRFLOW	28.9	29.3	30.2	-	28.6	29.0	29.9	-	27.9	28.3	29.2	-	26.6	27.0	27.9	-	25.0	25.4	26.3	-	23.5	24.0	24.8	-	28.9	29.3	30.2	-	28.6	29.0	29.9	-	27.9	28.3	29.2	-	26.6	27.0	27.9	-	25.0	25.4	26.3	-	23.5	24.0	24.8	-
		MBh	0.62	0.54	0.40	-	0.63	0.55	0.41	-	0.65	0.58	0.44	-	0.67	0.60	0.46	-	1.00	0.62	0.48	-	1.00	0.67	0.53	-	0.62	0.54	0.40	-	0.63	0.55	0.41	-	0.65	0.58	0.44	-	0.67	0.60	0.46	-	1.00	0.62	0.48	-	1.00	0.67	0.53	-
		S/T	19	17	14	-	19	17	14	-	19	17	14	-	19	17	14	-	19	17	14	-	19	17	14	-	19	17	14	-	19	17	14	-	19	17	14	-	19	17	14	-	19	17	14	-	19	17	14	-
		ΔT	1.63	1.63	1.62	-	1.81	1.81	1.81	-	2.02	2.02	2.01	-	2.24	2.24	2.24	-	2.49	2.49	2.49	-	2.78	2.78	2.78	-	1.63	1.63	1.62	-	1.81	1.81	1.81	-	2.02	2.02	2.01	-	2.24	2.24	2.24	-	2.49	2.49	2.49	-	2.78	2.78	2.78	-
		kW	6.0	6.0	6.0	-	6.9	6.9	6.8	-	7.8	7.8	7.8	-	8.8	8.8	8.8	-	10.0	10.0	9.9	-	11.3	11.3	11.3	-	6.0	6.0	6.0	-	6.9	6.9	6.8	-	7.8	7.8	7.8	-	8.8	8.8	8.8	-	10.0	10.0	9.9	-	11.3	11.3	11.3	-
	Amps	240	241	243	-	278	279	281	-	318	319	321	-	361	362	363	-	407	408	409	-	456	457	459	-	240	241	243	-	278	279	281	-	318	319	321	-	361	362	363	-	407	408	409	-	456	457	459	-	
	Hi PR	120	122	125	-	128	129	132	-	134	136	139	-	140	141	144	-	145	146	149	-	152	153	156	-	120	122	125	-	128	129	132	-	134	136	139	-	140	141	144	-	145	146	149	-	152	153	156	-	
	Lo PR	29.3	29.7	30.5	-	29.0	29.4	30.3	-	28.3	28.7	29.5	-	27.4	27.4	28.2	-	25.4	25.8	26.6	-	23.9	24.3	25.2	-	29.3	29.7	30.5	-	29.0	29.4	30.3	-	28.3	28.7	29.5	-	27.4	27.4	28.2	-	25.4	25.8	26.6	-	23.9	24.3	25.2	-	
	MBh	0.68	0.61	0.47	-	0.69	0.61	0.47	-	0.72	0.64	0.50	-	0.74	0.66	0.52	-	1.00	0.68	0.54	-	1.00	0.73	0.59	-	0.68	0.61	0.47	-	0.69	0.61	0.47	-	0.72	0.64	0.50	-	0.74	0.66	0.52	-	1.00	0.68	0.54	-	1.00	0.73	0.59	-	
	S/T	18	16	13	-	18	16	13	-	18	16	13	-	18	16	13	-	18	16	13	-	19	17	14	-	18	16	13	-	18	16	13	-	18	16	13	-	18	16	13	-	18	16	13	-	19	17	14	-	
ΔT	1.64	1.64	1.63	-	1.82	1.82	1.82	-	2.03	2.03	2.02	-	2.25	2.25	2.25	-	2.50	2.50	2.50	-	2.79	2.79	2.79	-	1.64	1.64	1.63	-	1.82	1.82	1.82	-	2.03	2.03	2.02	-	2.25	2.25	2.25	-	2.50	2.50	2.50	-	2.79	2.79	2.79	-		
kW	6.1	6.1	6.0	-	6.9	6.9	6.9	-	7.8	7.8	7.8	-	8.9	8.9	8.8	-	10.0	10.0	10.0	-	11.3	11.3	11.3	-	6.1	6.1	6.0	-	6.9	6.9	6.9	-	7.8	7.8	7.8	-	8.9	8.9	8.8	-	10.0	10.0	10.0	-	11.3	11.3	11.3	-		
Amps	242	243	245	-	280	281	283	-	320	321	323	-	363	364	365	-	409	410	412	-	458	459	461	-	242	243	245	-	280	281	283	-	320	321	323	-	363	364	365	-	409	410	412	-	458	459	461	-		
Hi PR	122	124	127	-	130	131	134	-	136	137	140	-	141	143	146	-	147	148	151	-	153	155	158	-	122	124	127	-	130	131	134	-	136	137	140	-	141	143	146	-	147	148	151	-	153	155	158	-		
Lo PR	29.7	30.1	31.0	-	29.5	29.9	30.7	-	28.7	29.1	30.0	-	27.4	27.8	28.7	-	25.8	26.2	27.1	-	24.4	24.8	25.7	-	29.7	30.1	31.0	-	29.5	29.9	30.7	-	28.7	29.1	30.0	-	27.4	27.8	28.7	-	25.8	26.2	27.1	-	24.4	24.8	25.7	-		
MBh	0.72	0.64	0.50	-	0.72	0.65	0.51	-	0.75	0.67	0.53	-	0.77	0.69	0.55	-	1.00	0.71	0.58	-	1.00	0.77	0.63	-	0.72	0.64	0.50	-	0.72	0.65	0.51	-	0.75	0.67	0.53	-	0.77	0.69	0.55	-	1.00	0.71	0.58	-	1.00	0.77	0.63	-		
S/T	17	15	12	-	17	15	12	-	17	15	12	-	17	15	12	-	17	15	12	-	18	16	13	-	17	15	12	-	17	15	12	-	17	15	12	-	17	15	12	-	17	15	12	-	18	16	13	-		
ΔT	1.65	1.64	1.64	-	1.83	1.83	1.83	-	2.04	2.03	2.03	-	2.26	2.26	2.25	-	2.51	2.51	2.50	-	2.80	2.80	2.80	-	1.65	1.64	1.64	-	1.83	1.83	1.83	-	2.04	2.03	2.03	-	2.26	2.26	2.25	-	2.51	2.51	2.50	-	2.80	2.80	2.80	-		
kW	6.1	6.1	6.1	-	6.9	6.9	6.9	-	7.9	7.9	7.9	-	8.9	8.9	8.9	-	10.0	10.0	10.0	-	11.4	11.4	11.4	-	6.1	6.1	6.1	-	6.9	6.9	6.9	-	7.9	7.9	7.9	-	8.9	8.9	8.9	-	10.0	10.0	10.0	-	11.4	11.4	11.4	-		
Amps	244	245	247	-	282	283	285	-	322	323	325	-	365	366	367	-	411	412	414	-	460	461	463	-	244	245	247	-	282	283	285	-	322	323	325	-	365	366	367	-	411	412	414	-	460	461	463	-		
Hi PR	124	126	129	-	131	133	136	-	138	139	142	-	143	145	148	-	149	150	153	-	155	157	160	-	124	126	129	-	131	133	136	-	138	139	142	-	143	145	148	-	149	150	153	-	155	157	160	-		
Lo PR	28.9	29.3	30.2	31.5	28.7	29.1	29.9	31.2	27.9	28.3	29.2	30.5	26.6	27.0	27.9	29.2	25.0	25.4	26.3	27.6	23.6	24.0	24.8	26.2	28.9	29.3	30.2	31.5	28.7	29.1	29.9	31.2	27.9	28.3	29.2	30.5	26.6	27.0	27.9	29.2	25.0	25.4	26.3	27.6	23.6	24.0	24.8	26.2		
MBh	0.75	0.68	0.54	0.39	0.76	0.68	0.54	0.40	1.00	0.71	0.57	0.42	1.00	0.73	0.59	0.44	1.00	0.75	0.61	0.47	1.00	0.80	0.52	0.52	0.75	0.68	0.54	0.39	0.76	0.68	0.54	0.40	1.00	0.71	0.57	0.42	1.00	0.73	0.59	0.44	1.00	0.75	0.61	0.47	1.00	0.80	0.56	0.52		
S/T	23	21	18	14	23	21	18	14	23	21	18	15	23	21	18	14	23	21	18	14	24	22	19	15	23	21	18	14	23	21	18	14	23	21	18	15	23	21	18	14	23	21	18	14	24	22	19	15		
ΔT	1.63	1.63	1.62	1.64	1.81	1.81	1.81	1.82	2.02	2.02	2.01	2.03	2.24	2.24	2.24	2.25	2.49	2.49	2.48	2.50	2.78	2.78	2.78	2.79	1.63	1.63	1.62	1.64	1.81	1.81	1.81	1.82	2.02	2.02	2.01	2.03	2.24	2.24	2.24	2.25	2.49	2.49	2.48	2.50	2.78	2.78	2.78	2.79		
kW	6.0	6.0	6.0	6.1	6.9	6.8	6.8	6.9	7.8	7.8	7.8	7.8	8.8	8.8	8.8	8.9	10.0	10.0	9.9	10.0	11.3	11.3	11.3	11.3	6.0	6.0	6.0	6.1	6.9	6.8	6.8	6.9	7.8	7.8	7.8	7.8	8.8	8.8	8.8	8.9	10.0	10.0	9.9	10.0	11.3	11.3	11.3	11.3		
Amps	240	242	243	247	278	279	281	285	318	319	321	325	361	362	364	368	407	408	410	414	456	457	459	463	240	242	243	247	278	279	281	285	318	319	321	325	361	362	364	368	407	408	410	414	456	457	459	463		
Hi PR	120	122	125	130	128	129	132	137	134	136	139	144	140	141	144	149	145	146	149	155	152	153	156	161	120	122	125	130	128	129	132	137	134	136	139	144	140	141	144	149	145	146	149	155	152	153	156	161		
Lo PR	29.3	29.7	30.6	31.9	29.0	29.4	30.3	31.6	28.3	28.7	29.5	30.9	27.0	27.4	28.3	29.6	25.4	25.8	26.7	28.0	23.9	24.4	25.2	26.5	29.3	29.7	30.6	31.9	29.0	29.4	30.3	31.6	28.3	28.7	29.5	30.9	27.0	27.4	28.3	29.6	25.4	25.8	26.7	28.0	23.9	24.4	25.2	26.5		
MBh	0.82	0.74	0.60	0.45	0.82	0.74	0.60	0.46	1.00	0.77	0.63	0.48	1.00	0.79	0.65	0.50	1.00	0.81	0.67	0.53	1.00	1.00	0.73	0.58	0.82	0.74	0.60	0.45	0.82	0.74	0.60	0.46	1.00	0.77	0.63	0.48	1.00	0.79	0.65	0.50	1.00	0.81	0.67	0.53	1.00	1.00	0.73	0.58		
S/T	22	20	17	13	22	20	17	13	22	20	17	14	22	20	17	13	22	20	16	13	23	21	18	14																										

COOLING DATA — DZ5SEA3010A* + AMST30BU1400A* (CONT.)

IDB	AIRFLOW	OUTDOOR AMBIENT TEMPERATURE																									
		65°F				75°F				85°F				95°F				105°F				115°F					
		59	63	67	71	59	63	67	71	59	63	67	71	59	63	67	71	59	63	67	71	59	63	67	71		
80	875	MBh	29.1	29.5	30.3	31.6	28.8	29.2	30.1	31.4	28.0	28.5	29.3	30.6	26.7	27.2	28.0	29.3	25.2	25.6	26.4	27.8	23.7	24.1	25.0	26.3	
		S/T	0.88	0.80	0.67	0.52	1.00	0.81	0.67	0.53	1.00	0.84	0.70	0.55	1.00	0.86	0.72	0.57	1.00	1.00	0.74	0.59	1.00	1.00	0.79	0.65	
		ΔT	27	25	22	18	27	25	22	18	27	25	22	19	27	25	22	18	26	26	25	21	18	28	26	23	19
		kW	1.63	1.63	1.62	1.64	1.81	1.81	1.81	1.82	1.82	2.02	2.02	2.01	2.03	2.24	2.24	2.24	2.25	2.49	2.49	2.49	2.50	2.78	2.78	2.78	2.79
		Amps	6.0	6.0	6.0	6.1	6.9	6.9	6.8	6.9	7.8	7.8	7.8	7.8	7.8	8.8	8.8	8.8	8.9	10.0	10.0	10.0	10.0	11.3	11.3	11.3	11.3
	Hi PR	241	242	244	248	279	280	282	286	319	320	321	325	361	362	364	368	407	407	408	410	414	457	458	459	464	
	Lo PR	121	122	126	131	128	130	133	138	140	136	138	141	146	142	143	145	150	145	147	150	155	152	154	157	162	
	1000	MBh	29.4	29.8	30.7	32.0	29.2	29.6	30.5	31.8	28.4	28.8	29.7	31.0	27.1	27.5	28.4	29.7	25.5	26.0	26.8	28.1	24.1	24.5	25.4	26.7	
		S/T	1.00	0.87	0.73	0.58	1.00	0.87	0.73	0.59	1.00	0.90	0.76	0.61	1.00	0.92	0.78	0.63	1.00	1.00	0.80	0.66	1.00	1.00	0.85	0.71	
		ΔT	26	24	21	17	26	24	21	17	26	24	21	17	26	24	21	17	25	24	20	17	26	25	21	18	
kW		1.64	1.64	1.63	1.65	1.82	1.82	1.82	1.83	2.03	2.03	2.02	2.04	2.25	2.25	2.25	2.26	2.50	2.50	2.50	2.51	2.79	2.79	2.79	2.80		
Amps		6.1	6.1	6.0	6.1	6.9	6.9	6.9	6.9	7.8	7.8	7.8	7.9	8.9	8.9	8.9	8.9	10.0	10.0	10.0	10.0	11.3	11.3	11.3	11.4		
Hi PR	243	244	246	250	281	282	284	288	321	322	323	327	363	364	366	370	409	410	412	416	459	460	461	466			
Lo PR	123	124	127	132	130	132	135	140	136	138	141	146	142	143	146	152	147	149	152	157	154	155	158	164			
1125	MBh	29.9	30.3	31.2	32.5	29.6	30.0	30.9	32.2	28.9	29.3	30.2	31.5	27.6	28.0	28.9	30.2	26.0	26.4	27.3	28.6	24.5	25.0	25.8	27.1		
	S/T	1.00	0.90	0.76	0.62	1.00	0.91	0.77	0.62	1.00	0.93	0.79	0.65	1.00	1.00	0.81	0.67	1.00	1.00	0.84	0.69	1.00	1.00	0.89	0.74		
	ΔT	25	23	20	16	25	23	20	16	25	23	20	17	25	23	20	16	24	23	19	16	26	24	21	17		
	kW	1.65	1.64	1.64	1.65	1.83	1.83	1.83	1.84	2.04	2.03	2.03	2.05	2.26	2.26	2.26	2.27	2.51	2.51	2.51	2.52	2.80	2.80	2.80	2.81		
	Amps	6.1	6.1	6.1	6.1	6.9	6.9	6.9	7.0	7.9	7.9	7.9	7.9	8.9	8.9	8.9	8.9	10.0	10.0	10.0	10.1	11.4	11.4	11.4	11.4		
Hi PR	245	246	248	252	283	284	286	290	323	324	325	329	365	366	368	372	411	412	414	418	461	462	463	468			
Lo PR	125	126	129	134	132	134	137	142	138	140	143	148	144	145	148	154	149	151	154	159	156	157	160	166			
85	875	MBh	29.5	30.0	30.8	32.1	29.3	29.7	30.6	31.9	28.5	28.9	29.8	31.1	27.2	27.6	28.5	29.8	25.6	26.1	26.9	28.2	24.2	24.6	25.5	26.8	
		S/T	1.00	0.91	0.77	0.6	1.00	0.92	0.78	0.6	1.00	1.00	0.80	0.7	1.00	1.00	0.82	0.7	1.00	1.00	0.84	0.7	1.00	1.00	1.00	0.8	
		ΔT	30	28	25	22	30	28	25	22	30	28	25	22	30	28	25	22	30	28	25	21	31	29	26	23	
		kW	1.63	1.63	1.63	1.6	1.82	1.81	1.81	1.8	2.02	2.02	2.02	2.0	2.24	2.24	2.24	2.3	2.49	2.49	2.49	2.5	2.79	2.78	2.78	2.8	
		Amps	6.0	6.0	6.0	6.1	6.9	6.9	6.9	6.9	7.8	7.8	7.8	7.9	8.8	8.8	8.8	8.9	10.0	10.0	10.0	10.0	11.3	11.3	11.3	11.4	
	Hi PR	242	243	245	249	280	281	283	287	320	321	322	327	362	363	365	369	409	410	411	415	458	459	460	465		
	Lo PR	123	124	127	132	130	132	135	140	137	138	141	146	142	143	147	152	147	149	152	157	154	155	159	164		
	1000	MBh	29.9	30.3	31.2	32.5	29.7	30.1	30.9	32.3	28.9	29.3	30.2	31.5	27.6	28.0	28.9	30.2	26.0	26.4	27.3	28.6	24.6	25.0	25.9	27.2	
		S/T	1.00	0.97	0.83	0.7	1.00	0.98	0.84	0.7	1.00	1.00	0.86	0.7	1.00	1.00	0.88	0.7	1.00	1.00	0.91	0.8	1.00	1.00	1.00	0.8	
		ΔT	29	27	24	21	29	27	24	21	29	27	24	21	29	27	24	21	29	27	24	20	30	28	25	21	
kW		1.64	1.64	1.64	1.7	1.83	1.82	1.82	1.8	2.03	2.03	2.03	2.0	2.25	2.25	2.25	2.3	2.50	2.50	2.50	2.5	2.80	2.79	2.79	2.8		
Amps		6.1	6.1	6.1	6.1	6.9	6.9	6.9	7.0	7.9	7.9	7.8	7.9	8.9	8.9	8.9	8.9	10.0	10.0	10.0	10.1	11.4	11.4	11.3	11.4		
Hi PR	244	245	247	251	282	283	285	289	322	323	324	329	364	366	367	371	411	412	413	418	460	461	463	467			
Lo PR	125	126	129	134	132	133	136	142	138	140	143	148	144	145	148	153	149	151	154	159	156	157	160	165			
1125	MBh	30.4	30.8	31.7	33.0	30.1	30.5	31.4	32.7	29.4	29.8	30.6	32.0	28.1	28.5	29.3	30.7	26.5	26.9	27.8	29.1	25.0	25.4	26.3	27.6		
	S/T	1.00	1.00	0.87	0.7	1.00	1.00	0.87	0.7	1.00	1.00	0.90	0.8	1.00	1.00	0.92	0.8	1.00	1.00	0.94	0.8	1.00	1.00	1.00	0.8		
	ΔT	28	26	23	20	28	26	23	20	28	27	23	20	28	26	23	20	28	26	23	20	29	27	24	21		
	kW	1.65	1.65	1.64	1.7	1.83	1.83	1.83	1.8	2.04	2.04	2.03	2.0	2.26	2.26	2.26	2.3	2.51	2.51	2.51	2.5	2.80	2.80	2.80	2.8		
	Amps	6.1	6.1	6.1	6.2	7.0	6.9	6.9	7.0	7.9	7.9	7.9	7.9	8.9	8.9	8.9	9.0	10.1	10.1	10.0	10.1	11.4	11.4	11.4	11.4		
Hi PR	246	247	249	253	284	285	287	291	324	325	326	331	366	367	369	373	413	414	415	419	462	463	465	469			
Lo PR	127	128	131	136	134	135	138	144	140	142	145	150	146	147	150	155	151	152	156	161	158	159	162	167			

IDB: Entering Indoor Dry Bulb Temperature
 High and low pressures are measured at the liquid and suction service valves.
 Shaded area reflects AHRI Rating Conditions.
 kW = Total system power
 Amps = Outdoor unit amps (compressor + fan)

COOLING DATA — DZ5SEA3610A* + AMST42CU1400A*

		Outdoor Ambient Temperature																																			
		65°F						75°F						85°F						95°F						105°F						115°F					
		IDB	Airflow	59	63	67	71	59	63	67	71	59	63	67	71	59	63	67	71	59	63	67	71	59	63	67	71	59	63	67	71						
		Entering Indoor Wet Bulb Temperature																																			
70	1050	MBh	35.8	36.3	37.3	-	35.4	35.9	37.0	-	34.5	35.0	36.1	-	32.9	33.4	34.5	-	31.0	31.5	32.5	-	29.2	29.7	30.8	-	31.0	31.5	32.5	-	29.2	29.7	30.8	-			
		S/T	0.63	0.56	0.43	-	0.64	0.57	0.44	-	0.66	0.59	0.46	-	0.68	0.61	0.48	-	0.70	0.63	0.50	-	1.00	0.68	0.55	-	0.70	0.63	0.50	-	1.00	0.68	0.55	-			
	ΔT	19	17	14	-	19	17	14	-	19	17	14	-	19	17	14	-	19	17	13	-	20	18	14	-	19	17	13	-	20	18	14	-				
	kW	1.93	1.93	1.92	-	2.17	2.17	2.16	-	2.44	2.43	2.43	-	2.72	2.72	2.72	-	3.05	3.04	3.04	-	3.42	3.42	3.42	-	3.05	3.04	3.04	-	3.42	3.42	3.42	-				
	Amps	7.4	7.4	7.4	-	8.5	8.5	8.5	-	9.7	9.7	9.7	-	11.0	11.0	11.0	-	12.5	12.5	12.5	-	14.3	14.2	14.2	-	12.5	12.5	12.5	-	14.3	14.2	14.2	-				
	Hi PR	245	246	248	-	284	285	286	-	324	325	327	-	367	368	370	-	414	415	417	-	464	465	466	-	414	415	417	-	464	465	466	-				
	Lo PR	117	119	122	-	125	126	129	-	131	132	135	-	136	137	140	-	141	143	146	-	148	149	152	-	141	143	146	-	148	149	152	-				
	MBh	36.4	36.9	37.9	-	36.0	36.5	37.6	-	35.1	35.6	36.7	-	33.5	34.0	35.1	-	31.6	32.1	33.1	-	29.8	30.3	31.4	-	31.6	32.1	33.1	-	29.8	30.3	31.4	-				
	S/T	0.67	0.60	0.47	-	0.68	0.61	0.48	-	0.71	0.63	0.50	-	0.72	0.65	0.52	-	1.00	0.67	0.54	-	1.00	0.72	0.59	-	1.00	0.67	0.54	-	1.00	0.72	0.59	-				
	ΔT	18	16	13	-	18	16	13	-	18	16	13	-	18	16	13	-	17	16	12	-	19	17	13	-	17	16	12	-	19	17	13	-				
kW	1.94	1.94	1.94	-	2.18	2.18	2.17	-	2.45	2.45	2.44	-	2.74	2.73	2.73	-	3.06	3.06	3.05	-	3.44	3.43	3.43	-	3.06	3.06	3.05	-	3.44	3.43	3.43	-					
Amps	7.5	7.5	7.4	-	8.6	8.6	8.5	-	9.8	9.8	9.8	-	11.1	11.1	11.1	-	12.6	12.6	12.6	-	14.3	14.3	14.3	-	12.6	12.6	12.6	-	14.3	14.3	14.3	-					
Hi PR	247	248	250	-	286	287	289	-	326	327	329	-	369	370	372	-	416	417	419	-	466	467	469	-	416	417	419	-	466	467	469	-					
Lo PR	120	121	124	-	127	128	131	-	133	134	137	-	138	139	142	-	143	145	148	-	150	151	154	-	143	145	148	-	150	151	154	-					
MBh	37.1	37.6	38.7	-	36.8	37.3	38.3	-	35.9	36.4	37.4	-	34.3	34.8	35.8	-	32.3	32.8	33.9	-	30.5	31.0	32.1	-	32.3	32.8	33.9	-	30.5	31.0	32.1	-					
S/T	0.69	0.61	0.48	-	0.69	0.62	0.49	-	0.72	0.65	0.51	-	0.74	0.66	0.53	-	1.00	0.69	0.55	-	1.00	0.74	0.60	-	1.00	0.69	0.55	-	1.00	0.74	0.60	-					
ΔT	17	15	12	-	17	15	12	-	17	15	12	-	17	15	12	-	17	15	11	-	18	16	12	-	17	15	11	-	18	16	12	-					
kW	1.95	1.95	1.95	-	2.19	2.19	2.19	-	2.46	2.46	2.45	-	2.75	2.74	2.74	-	3.07	3.07	3.06	-	3.45	3.44	3.44	-	3.07	3.07	3.06	-	3.45	3.44	3.44	-					
Amps	7.5	7.5	7.5	-	8.6	8.6	8.6	-	9.8	9.8	9.8	-	11.1	11.1	11.1	-	12.6	12.6	12.6	-	14.4	14.3	14.3	-	12.6	12.6	12.6	-	14.4	14.3	14.3	-					
Hi PR	250	251	252	-	288	289	291	-	328	329	331	-	372	373	374	-	418	419	421	-	468	469	471	-	418	419	421	-	468	469	471	-					
Lo PR	122	123	126	-	129	130	133	-	135	137	140	-	140	142	145	-	146	147	150	-	152	153	156	-	146	147	150	-	152	153	156	-					

75	1050	MBh	35.8	36.3	37.3	39.0	35.5	36.0	37.0	38.6	34.5	35.0	36.1	37.7	32.9	33.4	34.5	36.1	31.0	31.5	32.6	34.2	29.2	29.7	30.8	32.4
		S/T	0.76	0.69	0.55	0.42	0.77	0.69	0.56	0.42	0.79	0.72	0.58	0.45	1.00	0.73	0.60	0.46	1.00	0.76	0.62	0.49	1.00	0.81	0.67	0.54
	ΔT	23	21	18	14	23	21	18	14	23	21	18	14	23	21	18	14	23	21	17	14	24	22	18	15	
	kW	1.93	1.93	1.92	1.94	2.17	2.17	2.16	2.18	2.43	2.43	2.43	2.45	2.72	2.72	2.72	2.73	2.73	3.04	3.04	3.04	3.06	3.42	3.42	3.42	
	Amps	7.4	7.4	7.4	7.5	8.5	8.5	8.5	8.6	9.7	9.7	9.7	9.8	11.0	11.0	11.0	11.1	11.1	12.5	12.5	12.5	12.6	14.2	14.2	14.3	
	Hi PR	245	246	248	252	284	285	287	291	324	325	327	331	367	368	370	374	374	414	415	415	417	421	464	465	467
	Lo PR	118	119	122	127	125	126	129	134	131	132	135	140	136	137	140	145	145	141	143	146	150	148	149	152	
	MBh	36.4	36.9	37.9	39.6	36.1	36.6	37.6	39.2	35.1	35.6	36.7	38.3	33.5	34.1	35.1	36.7	36.7	31.6	32.1	33.2	34.8	29.8	30.3	31.4	33.0
	S/T	0.80	0.73	0.60	0.46	0.81	0.73	0.60	0.46	0.83	0.76	0.63	0.49	1.00	0.78	0.64	0.51	0.51	1.00	0.80	0.67	0.53	1.00	0.85	0.72	0.58
	ΔT	22	20	17	13	22	20	17	13	22	20	17	13	22	20	17	13	22	20	16	13	23	21	17	14	
kW	1.94	1.94	1.93	1.95	2.18	2.18	2.17	2.19	2.45	2.44	2.44	2.46	2.73	2.73	2.73	2.75	2.75	3.06	3.05	3.05	3.07	3.43	3.43	3.43		
Amps	7.5	7.5	7.4	7.5	8.6	8.5	8.5	8.6	9.8	9.8	9.7	9.8	11.1	11.1	11.1	11.2	11.2	12.6	12.6	12.5	12.6	14.3	14.3	14.4		
Hi PR	248	249	250	255	286	287	289	293	326	327	329	333	370	371	372	377	377	416	417	419	423	466	467	473		
Lo PR	120	121	124	129	127	128	131	136	133	134	137	142	138	139	142	147	147	143	145	148	153	150	151	154		
MBh	37.1	37.6	38.7	40.3	36.8	37.3	38.4	40.0	35.9	36.4	37.4	39.1	34.3	34.8	35.8	37.5	37.5	32.3	32.8	33.9	35.5	30.6	31.1	32.1	33.7	
S/T	0.81	0.74	0.61	0.47	0.82	0.75	0.61	0.48	1.00	0.77	0.64	0.50	1.00	0.79	0.66	0.52	0.52	1.00	0.81	0.68	0.54	1.00	0.86	0.73	0.59	
ΔT	21	19	16	12	21	19	16	12	21	19	16	12	21	19	16	12	21	21	19	15	12	22	20	17	13	
kW	1.95	1.95	1.94	1.96	2.19	2.19	2.18	2.20	2.46	2.45	2.45	2.47	2.74	2.74	2.74	2.76	2.76	3.07	3.06	3.06	3.08	3.44	3.44	3.44		
Amps	7.5	7.5	7.5	7.6	8.6	8.6	8.6	8.7	9.8	9.8	9.8	9.9	11.1	11.1	11.1	11.2	11.2	12.6	12.6	12.6	12.7	14.3	14.3	14.4		
Hi PR	250	251	253	257	288	289	291	295	329	330	331	336	372	373	375	379	379	419	420	421	426	468	470	471		
Lo PR	122	123	126	131	129	130	133	138	135	137	140	145	140	142	145	150	150	146	147	150	155	152	153	156		

IDB: Entering Indoor Dry Bulb Temperature
 High and low pressures are measured at the liquid and suction service valves.
 Shaded area reflects ACCA (TVA) Rating Conditions.
 kW = Total system power
 Amps = Outdoor unit amps (compressor + fan)

COOLING DATA — DZ5SEA4210A* + AMST42CU1400A*

IDB	AIRFLOW	OUTDOOR AMBIENT TEMPERATURE																							
		65°F				75°F				85°F				95°F				105°F				115°F			
		59	63	67	71	59	63	67	71	59	63	67	71	59	63	67	71	59	63	67	71	59	63	67	71
70	MBh	40.9	41.4	42.6	-	40.5	41.1	42.3	-	39.4	40.0	41.2	-	37.6	38.2	39.4	-	35.4	35.9	37.2	-	33.3	33.9	35.1	-
	S/T	0.63	0.56	0.42	-	0.64	0.56	0.43	-	0.66	0.59	0.45	-	0.68	0.61	0.47	-	1.00	0.63	0.49	-	1.00	0.68	0.54	-
	ΔT	19	17	14	-	19	17	14	-	19	17	14	-	19	17	14	-	18	17	13	-	19	18	14	-
	kW	2.25	2.24	2.24	-	2.50	2.50	2.49	-	2.78	2.78	2.77	-	3.09	3.08	3.08	-	3.43	3.43	3.42	-	3.83	3.83	3.82	-
	Amps	8.2	8.2	8.2	-	9.4	9.4	9.3	-	10.7	10.7	10.6	-	12.1	12.1	12.0	-	13.6	13.6	13.6	-	15.5	15.4	15.4	-
	Hi PR	240	241	243	-	278	279	281	-	318	319	321	-	361	362	363	-	407	408	409	-	456	457	458	-
	Lo PR	120	121	124	-	127	129	132	-	134	135	138	-	139	140	143	-	144	146	149	-	151	152	155	-
	MBh	41.2	41.8	43.0	-	40.9	41.4	42.7	-	39.8	40.4	41.6	-	38.0	38.5	39.8	-	35.7	36.3	37.5	-	33.7	34.3	35.5	-
	S/T	0.67	0.59	0.46	-	0.68	0.60	0.46	-	0.70	0.63	0.49	-	0.72	0.64	0.51	-	1.00	0.67	0.53	-	1.00	0.72	0.58	-
	ΔT	18	16	13	-	18	16	13	-	18	16	13	-	18	16	13	-	18	16	13	-	19	17	14	-
kW	2.26	2.25	2.25	-	2.51	2.51	2.50	-	2.79	2.79	2.78	-	3.10	3.09	3.09	-	3.44	3.43	3.43	-	3.84	3.83	3.83	-	
Amps	8.3	8.2	8.2	-	9.4	9.4	9.4	-	10.7	10.7	10.7	-	12.1	12.1	12.1	-	13.7	13.7	13.6	-	15.5	15.5	15.5	-	
Hi PR	242	243	245	-	280	281	282	-	319	320	322	-	362	363	365	-	408	409	411	-	457	458	460	-	
Lo PR	121	123	126	-	128	130	133	-	135	136	139	-	140	142	145	-	145	147	150	-	152	154	157	-	
MBh	42.2	42.7	44.0	-	41.8	42.4	43.6	-	40.7	41.3	42.5	-	38.9	39.5	40.7	-	36.7	37.3	38.5	-	34.6	35.2	36.4	-	
S/T	0.71	0.63	0.50	-	0.72	0.64	0.50	-	0.74	0.67	0.53	-	0.76	0.69	0.55	-	1.00	0.71	0.57	-	1.00	0.76	0.62	-	
ΔT	17	15	12	-	17	15	12	-	17	15	12	-	17	15	12	-	16	15	11	-	18	16	12	-	
kW	2.27	2.27	2.26	-	2.52	2.52	2.52	-	2.81	2.80	2.80	-	3.11	3.11	3.10	-	3.45	3.45	3.45	-	3.85	3.85	3.85	-	
Amps	8.3	8.3	8.3	-	9.5	9.5	9.5	-	10.8	10.8	10.7	-	12.2	12.2	12.1	-	13.7	13.7	13.7	-	15.6	15.6	15.5	-	
Hi PR	245	246	247	-	282	283	285	-	322	323	325	-	365	366	368	-	411	412	414	-	460	461	463	-	
Lo PR	124	125	128	-	131	133	136	-	138	139	142	-	143	144	148	-	148	150	153	-	155	156	159	-	
75	MBh	40.9	41.5	42.7	44.5	40.5	41.1	42.3	44.2	39.4	40.0	41.2	43.1	37.6	38.2	39.4	41.3	35.4	36.0	37.2	39.0	33.3	33.9	35.1	37.0
	S/T	0.76	0.69	0.55	0.40	0.77	0.69	0.55	0.41	1.00	0.72	0.58	0.44	1.00	0.74	0.60	0.46	1.00	0.76	0.62	0.48	1.00	0.81	0.67	0.53
	ΔT	23	21	17	14	22	21	17	14	23	21	18	14	22	21	17	14	22	20	17	14	23	22	18	15
	kW	2.24	2.24	2.24	2.26	2.50	2.50	2.49	2.51	2.78	2.78	2.77	2.79	3.08	3.08	3.08	3.10	3.43	3.42	3.42	3.44	3.83	3.82	3.82	3.84
	Amps	8.2	8.2	8.2	8.3	9.4	9.4	9.3	9.4	10.7	10.6	10.6	10.7	12.1	12.0	12.0	12.1	13.6	13.6	13.6	13.7	15.4	15.4	15.4	15.5
	Hi PR	241	242	243	248	278	280	281	285	318	319	321	325	361	362	364	368	407	408	410	414	456	457	459	463
	Lo PR	120	121	124	130	127	129	132	137	134	135	138	143	139	140	144	149	144	146	149	154	151	152	155	160
	MBh	41.3	41.8	43.0	44.9	40.9	41.5	42.7	44.5	39.8	40.4	41.6	43.5	38.0	38.6	39.8	41.6	35.8	36.3	37.6	39.4	33.7	34.3	35.5	37.4
	S/T	0.80	0.72	0.59	0.44	0.81	0.73	0.59	0.45	1.00	0.75	0.62	0.47	1.00	0.77	0.64	0.49	1.00	0.80	0.66	0.52	1.00	0.85	0.71	0.57
	ΔT	22	20	17	13	22	20	17	13	22	20	17	14	22	20	17	13	22	20	16	13	23	21	18	14
kW	2.25	2.25	2.25	2.27	2.51	2.50	2.50	2.52	2.79	2.79	2.78	2.80	3.09	3.09	3.09	3.11	3.43	3.43	3.43	3.45	3.84	3.83	3.83	3.85	
Amps	8.2	8.2	8.2	8.3	9.4	9.4	9.4	9.5	10.7	10.7	10.7	10.8	12.1	12.1	12.1	12.2	13.7	13.6	13.6	13.7	15.5	15.5	15.5	15.5	
Hi PR	242	243	245	249	280	281	283	287	320	321	322	326	362	363	365	369	408	409	411	415	457	458	460	464	
Lo PR	121	123	126	131	128	130	133	138	135	136	139	144	140	142	145	150	145	147	150	155	152	154	157	162	
MBh	42.2	42.8	44.0	45.8	41.8	42.4	43.6	45.5	40.8	41.3	42.6	44.4	38.9	39.5	40.7	42.6	36.7	37.3	38.5	40.3	34.7	35.2	36.5	38.3	
S/T	0.84	0.76	0.63	0.48	0.85	0.77	0.63	0.49	1.00	0.80	0.66	0.52	1.00	0.82	0.68	0.54	1.00	0.84	0.70	0.56	1.00	1.00	0.75	0.61	
ΔT	21	19	16	12	21	19	15	12	21	19	16	12	21	19	15	12	20	19	15	12	21	20	16	13	
kW	2.27	2.27	2.26	2.28	2.52	2.52	2.51	2.53	2.80	2.80	2.80	2.82	3.11	3.11	3.10	3.12	3.45	3.45	3.44	3.46	3.85	3.85	3.84	3.86	
Amps	8.3	8.3	8.3	8.4	9.5	9.5	9.4	9.5	10.8	10.8	10.7	10.8	12.2	12.2	12.1	12.2	13.7	13.7	13.7	13.8	15.6	15.5	15.5	15.6	
Hi PR	245	246	248	252	283	284	285	290	322	323	325	329	365	366	368	372	411	412	414	418	460	461	463	467	
Lo PR	124	125	129	134	131	133	136	141	138	139	142	147	143	144	148	153	148	150	153	158	155	156	159	165	

IDB: Entering Indoor Dry Bulb Temperature
 High and low pressures are measured at the liquid and suction service valves.
 Shaded area reflects ACCA (TVA) Rating Conditions.
 kW = Total system power
 Amps = Outdoor unit amps (compressor + fan)

COOLING DATA — DZ5SEA4210A* + AMST42CU1400A* (CONT.)

IDB		OUTDOOR AMBIENT TEMPERATURE																							
		65°F				75°F				85°F				95°F				105°F				115°F			
		59	63	67	71	59	63	67	71	59	63	67	71	59	63	67	71	59	63	67	71	59	63	67	71
		ENTERING INDOOR WET BULB TEMPERATURE																							
AIRFLOW																									
1225	MBh	41.1	41.7	42.9	44.7	40.7	41.3	42.5	44.4	39.7	40.2	41.5	43.3	37.8	38.4	39.6	41.5	35.6	36.2	37.4	39.2	33.6	34.1	35.3	37.2
	S/T	0.89	0.81	0.67	0.53	1.00	0.82	0.68	0.54	1.00	0.84	0.71	0.56	1.00	0.86	0.73	0.58	1.00	1.00	0.75	0.60	1.00	1.00	0.80	0.66
	ΔT	26	25	21	18	26	25	22	18	27	25	22	18	26	25	21	18	26	24	21	18	27	25	22	19
	kW	2.25	2.24	2.24	2.26	2.50	2.50	2.49	2.51	2.78	2.78	2.77	2.79	3.09	3.08	3.08	3.10	3.43	3.43	3.42	3.44	3.83	3.83	3.82	3.84
	Amps	8.2	8.2	8.2	8.3	9.4	9.4	9.3	9.4	10.7	10.7	10.6	10.7	12.1	12.1	12.0	12.1	13.6	13.6	13.6	13.7	15.5	15.4	15.4	15.5
	Hi PR	241	242	244	248	279	280	282	286	319	320	321	325	361	362	364	368	407	408	410	414	456	457	459	463
Lo PR	121	122	125	130	128	129	132	137	134	136	139	144	140	141	144	149	145	146	149	154	151	153	156	161	
80	MBh	41.5	42.0	43.3	45.1	41.1	41.7	42.9	44.7	40.0	40.6	41.8	43.7	38.2	38.8	40.0	41.9	36.0	36.5	37.8	39.6	33.9	34.5	35.7	37.6
	S/T	0.93	0.85	0.71	0.57	1.00	0.86	0.72	0.58	1.00	0.88	0.74	0.60	1.00	1.00	0.90	0.76	1.00	1.00	0.79	0.64	1.00	1.00	0.84	0.69
	ΔT	26	24	21	17	26	24	21	17	26	24	21	17	26	24	21	17	25	24	20	17	26	25	21	18
	kW	2.25	2.25	2.25	2.27	2.51	2.51	2.50	2.52	2.79	2.79	2.78	2.80	3.10	3.09	3.09	3.11	3.44	3.43	3.43	3.45	3.84	3.83	3.83	3.85
	Amps	8.3	8.2	8.2	8.3	9.4	9.4	9.4	9.5	10.7	10.7	10.7	10.8	12.1	12.1	12.1	12.2	13.7	13.7	13.6	13.7	15.5	15.5	15.5	15.6
	Hi PR	242	244	245	249	280	281	283	287	320	321	323	327	363	364	365	370	409	410	411	416	458	459	461	465
Lo PR	122	123	126	131	129	130	134	139	135	137	140	145	141	142	145	150	146	147	151	156	153	154	157	162	
1575	MBh	42.4	43.0	44.2	46.0	42.0	42.6	43.8	45.7	41.0	41.5	42.8	44.6	39.1	39.7	40.9	42.8	36.9	37.5	38.7	40.6	34.9	35.4	36.7	38.5
	S/T	1.00	0.89	0.75	0.61	1.00	0.90	0.76	0.62	1.00	0.92	0.79	0.64	1.00	1.00	0.94	0.81	1.00	1.00	0.83	0.68	1.00	1.00	0.88	0.74
	ΔT	24	23	19	16	24	23	19	16	25	23	20	16	24	23	19	16	24	22	19	16	25	24	20	17
	kW	2.27	2.27	2.26	2.28	2.52	2.52	2.52	2.54	2.80	2.80	2.80	2.82	3.11	3.11	3.10	3.12	3.45	3.45	3.44	3.46	3.85	3.85	3.85	3.86
	Amps	8.3	8.3	8.3	8.4	9.5	9.5	9.5	9.5	10.8	10.8	10.7	10.8	12.2	12.2	12.1	12.2	13.7	13.7	13.7	13.8	15.6	15.6	15.5	15.6
	Hi PR	245	246	248	252	283	284	286	290	323	324	325	330	365	366	368	372	411	412	414	418	461	462	463	467
Lo PR	125	126	129	134	132	133	136	141	138	140	143	148	144	145	148	153	149	150	153	158	155	157	160	165	

1225	MBh	41.8	42.3	43.6	45.4	41.4	42.0	43.2	45.1	40.3	40.9	42.1	44.0	38.5	39.1	40.3	42.2	36.3	36.9	38.1	39.9	34.2	34.8	36.0	37.9
	S/T	1.00	0.91	0.78	0.6	1.00	0.92	0.78	0.6	1.00	1.00	0.81	0.7	1.00	1.00	0.83	0.7	1.00	1.00	0.85	0.7	1.00	1.00	0.90	0.8
	ΔT	30	28	25	21	30	28	25	21	30	28	25	22	30	28	25	21	30	28	25	21	31	29	26	22
	kW	2.25	2.25	2.24	2.3	2.50	2.50	2.50	2.5	2.79	2.78	2.78	2.8	3.09	3.09	3.08	3.1	3.43	3.43	3.43	3.4	3.83	3.83	3.83	3.8
	Amps	8.2	8.2	8.2	8.3	9.4	9.4	9.4	9.5	10.7	10.7	10.7	10.7	12.1	12.1	12.1	12.1	13.6	13.6	13.6	13.7	15.5	15.5	15.4	15.5
	Hi PR	242	243	245	249	280	281	283	287	320	321	322	327	362	363	365	369	408	409	411	415	458	459	460	464
Lo PR	122	124	127	132	130	131	134	139	136	137	140	146	141	143	146	151	147	148	151	156	153	155	158	163	
85	MBh	42.2	42.7	43.9	45.8	41.8	42.4	43.6	45.4	40.7	41.3	42.5	44.4	38.9	39.5	40.7	42.5	36.7	37.2	38.5	40.3	34.6	35.2	36.4	38.3
	S/T	1.00	0.95	0.82	0.7	1.00	0.96	0.82	0.7	1.00	1.00	0.85	0.7	1.00	1.00	0.87	0.7	1.00	1.00	0.89	0.7	1.00	1.00	1.00	0.8
	ΔT	29	27	24	21	29	27	24	21	29	28	24	21	29	27	24	21	29	27	24	20	30	28	25	22
	kW	2.26	2.26	2.25	2.3	2.51	2.51	2.51	2.5	2.79	2.79	2.79	2.8	3.10	3.10	3.09	3.1	3.44	3.44	3.43	3.5	3.84	3.84	3.83	3.9
	Amps	8.3	8.3	8.2	8.3	9.4	9.4	9.4	9.5	10.7	10.7	10.7	10.8	12.1	12.1	12.1	12.2	13.7	13.7	13.7	13.7	15.5	15.5	15.5	15.6
	Hi PR	244	245	246	251	281	282	284	288	321	322	324	328	364	365	366	371	410	411	413	417	459	460	462	466
Lo PR	124	125	128	133	131	132	135	140	137	139	142	147	143	144	147	152	148	149	152	157	154	156	159	164	
1575	MBh	43.1	43.7	44.9	46.7	42.7	43.3	44.5	46.4	41.7	42.2	43.4	45.3	39.8	40.4	41.6	43.5	37.6	38.2	39.4	41.2	35.6	36.1	37.3	39.2
	S/T	1.00	0.99	0.86	0.7	1.00	1.00	0.86	0.7	1.00	1.00	0.89	0.7	1.00	1.00	0.91	0.8	1.00	1.00	0.93	0.8	1.00	1.00	1.00	0.8
	ΔT	28	26	23	19	28	26	23	19	28	26	23	20	28	26	23	19	28	26	23	19	29	27	24	20
	kW	2.27	2.27	2.27	2.3	2.53	2.53	2.52	2.5	2.81	2.81	2.80	2.8	3.11	3.11	3.11	3.1	3.46	3.45	3.45	3.5	3.86	3.85	3.85	3.9
	Amps	8.3	8.3	8.3	8.4	9.5	9.5	9.5	9.6	10.8	10.8	10.8	10.9	12.2	12.2	12.2	12.3	13.8	13.7	13.7	13.8	15.6	15.6	15.6	15.6
	Hi PR	246	247	249	253	284	285	287	291	324	325	327	331	367	368	369	373	413	414	415	419	462	463	464	469
Lo PR	126	128	131	136	134	135	138	143	140	141	144	150	145	147	150	155	151	152	155	160	157	159	162	167	

IDB: Entering Indoor Dry Bulb Temperature
 High and low pressures are measured at the liquid and suction service valves.
 Shaded area reflects AHRI Rating Conditions.
 kW = Total system power
 Amps = Outdoor unit amps (compressor + fan)

COOLING DATA — DZ5SEA4810A* + AMST48CU1400A*

IDB		OUTDOOR AMBIENT TEMPERATURE																																			
		65°F						75°F						85°F						95°F						105°F						115°F					
		59	63	67	71	59	63	67	71	59	63	67	71	59	63	67	71	59	63	67	71	59	63	67	71	59	63	67	71								
		ENTERING INDOOR WET BULB TEMPERATURE																																			
AIRFLOW																																					
1450	MBh	46.9	47.5	48.9	-	46.4	47.1	48.5	-	45.2	45.9	47.3	-	43.2	43.8	45.2	-	40.6	41.3	42.7	-	38.3	39.0	40.3	-	38.3	39.0	40.3	-								
	S/T	0.65	0.57	0.44	-	0.66	0.58	0.45	-	0.68	0.61	0.47	-	0.70	0.62	0.49	-	1.00	0.65	0.51	-	1.00	0.70	0.56	-	1.00	0.70	0.56	-								
	ΔT	19	17	13	-	18	17	13	-	18	17	14	-	18	17	13	-	18	16	13	-	19	18	14	-	19	18	14	-								
	kW	2.52	2.52	2.51	-	2.81	2.81	2.81	-	3.14	3.14	3.13	-	3.50	3.49	3.49	-	3.89	3.89	3.88	-	4.35	4.35	4.35	-	4.35	4.35	4.35	-								
	Amps	9.4	9.3	9.3	-	10.7	10.7	10.7	-	12.2	12.2	12.2	-	13.8	13.8	13.8	-	15.6	15.6	15.6	-	17.7	17.7	17.7	-	17.7	17.7	17.7	-								
	Hi-PR	244	245	247	-	282	283	285	-	322	323	325	-	365	366	368	-	412	413	414	-	461	462	464	-	461	462	464	-								
Lo-PR	120	122	125	-	128	129	132	-	134	136	139	-	139	141	144	-	145	146	149	-	151	153	156	-	151	153	156	-									
70	MBh	47.4	48.1	49.5	-	47.0	47.7	49.1	-	45.8	46.5	47.9	-	43.7	44.4	45.8	-	41.2	41.9	43.2	-	38.9	39.5	40.9	-	38.9	39.5	40.9	-								
	S/T	0.68	0.60	0.47	-	0.69	0.61	0.48	-	0.71	0.64	0.50	-	0.73	0.65	0.52	-	1.00	0.68	0.54	-	1.00	0.73	0.59	-	1.00	0.73	0.59	-								
	ΔT	18	16	13	-	18	16	13	-	18	16	13	-	18	16	13	-	17	16	12	-	19	17	13	-	19	17	13	-								
	kW	2.53	2.53	2.52	-	2.82	2.82	2.82	-	3.15	3.15	3.14	-	3.51	3.50	3.50	-	3.90	3.90	3.89	-	4.37	4.36	4.36	-	4.37	4.36	4.36	-								
	Amps	9.4	9.4	9.4	-	10.7	10.7	10.7	-	12.2	12.2	12.2	-	13.9	13.8	13.8	-	15.7	15.7	15.6	-	17.8	17.8	17.8	-	17.8	17.8	17.8	-								
	Hi-PR	245	247	248	-	284	285	286	-	324	325	326	-	367	368	369	-	413	414	416	-	463	464	465	-	463	464	465	-								
Lo-PR	122	124	127	-	129	131	134	-	136	137	140	-	141	142	145	-	146	148	151	-	153	154	157	-	153	154	157	-									
1800	MBh	48.4	49.0	50.4	-	48.0	48.6	50.0	-	46.8	47.4	48.8	-	44.7	45.3	46.7	-	42.1	42.8	44.2	-	39.8	40.5	41.8	-	39.8	40.5	41.8	-								
	S/T	0.70	0.62	0.49	-	0.70	0.63	0.49	-	0.73	0.65	0.52	-	1.00	0.67	0.54	-	1.00	0.69	0.56	-	1.00	0.74	0.61	-	1.00	0.74	0.61	-								
	ΔT	17	15	12	-	17	15	12	-	17	15	12	-	17	15	12	-	17	15	11	-	18	16	12	-	18	16	12	-								
	kW	2.54	2.54	2.54	-	2.84	2.84	2.83	-	3.16	3.16	3.16	-	3.52	3.52	3.51	-	3.91	3.91	3.91	-	4.38	4.38	4.37	-	4.38	4.38	4.37	-								
	Amps	9.5	9.4	9.4	-	10.8	10.8	10.8	-	12.3	12.3	12.3	-	13.9	13.9	13.9	-	15.7	15.7	15.7	-	17.8	17.8	17.8	-	17.8	17.8	17.8	-								
	Hi-PR	248	249	250	-	286	287	289	-	326	327	329	-	369	370	372	-	415	416	418	-	465	466	468	-	465	466	468	-								
Lo-PR	124	126	129	-	132	133	136	-	138	139	142	-	143	145	148	-	149	150	153	-	155	157	160	-	155	157	160	-									
1450	MBh	46.9	47.5	48.9	51.0	46.5	47.1	48.5	50.6	45.3	45.9	47.3	49.4	43.2	43.8	45.2	47.3	40.6	41.3	42.7	44.8	38.3	39.0	40.4	42.5	38.3	39.0	40.4	42.5								
	S/T	0.78	0.70	0.57	0.43	0.78	0.71	0.57	0.43	1.00	0.73	0.60	0.46	1.00	0.75	0.62	0.48	1.00	0.77	0.64	0.50	1.00	0.82	0.69	0.55	1.00	0.82	0.69	0.55								
	ΔT	23	21	17	14	22	21	17	14	23	21	18	14	22	21	17	14	22	20	17	14	23	22	18	15	23	22	18	15								
	kW	2.52	2.52	2.51	2.53	2.81	2.81	2.80	2.83	3.14	3.14	3.13	3.15	3.49	3.49	3.49	3.51	3.89	3.89	3.88	3.90	4.35	4.35	4.35	4.37	4.35	4.35	4.35	4.37								
	Amps	9.3	9.3	9.3	9.4	10.7	10.7	10.6	10.8	12.2	12.2	12.1	12.2	13.8	13.8	13.8	13.9	15.6	15.6	15.6	15.7	17.7	17.7	17.7	17.8	17.7	17.7	17.7	17.8								
	Hi-PR	244	245	247	251	282	283	285	289	322	323	325	329	365	366	368	372	412	413	414	419	461	462	464	468	461	462	464	468								
Lo-PR	121	122	125	130	128	129	132	137	134	136	139	144	139	141	144	149	145	146	149	154	151	153	156	161	151	153	156	161									
75	MBh	47.5	48.1	49.5	51.6	47.1	47.7	49.1	51.2	45.9	46.5	47.9	50.0	43.8	44.4	45.8	47.9	41.2	41.9	43.3	45.4	38.9	39.6	40.9	43.1	38.9	39.6	40.9	43.1								
	S/T	0.81	0.73	0.60	0.46	0.81	0.74	0.60	0.46	1.00	0.76	0.63	0.49	1.00	0.78	0.65	0.51	1.00	0.80	0.67	0.53	1.00	0.85	0.72	0.58	1.00	0.85	0.72	0.58								
	ΔT	22	20	17	13	22	20	16	13	22	20	17	13	22	20	16	13	21	20	16	13	23	21	17	14	23	21	17	14								
	kW	2.53	2.53	2.52	2.54	2.82	2.82	2.82	2.84	3.15	3.15	3.14	3.17	3.50	3.50	3.50	3.52	3.90	3.90	3.89	3.91	4.36	4.36	4.36	4.38	4.36	4.36	4.36	4.38								
	Amps	9.4	9.4	9.4	9.5	10.7	10.7	10.7	10.8	12.2	12.2	12.2	12.3	13.8	13.8	13.8	13.9	15.7	15.6	15.6	15.7	17.8	17.8	17.7	17.9	17.8	17.8	17.7	17.9								
	Hi-PR	246	247	248	253	284	285	287	291	324	325	327	331	367	368	370	374	413	414	416	420	463	464	466	470	463	464	466	470								
Lo-PR	122	124	127	132	129	131	134	139	136	137	140	145	141	142	145	151	146	148	151	156	153	154	157	162	153	154	157	162									
1600	MBh	48.4	49.1	50.4	52.6	48.0	48.6	50.0	52.1	46.8	47.4	48.8	50.9	44.7	45.4	46.7	48.9	42.2	42.8	44.2	46.3	39.8	40.5	41.9	44.0	39.8	40.5	41.9	44.0								
	S/T	0.82	0.75	0.61	0.47	0.83	0.75	0.62	0.48	1.00	0.78	0.65	0.51	1.00	0.80	0.66	0.52	1.00	0.82	0.69	0.55	1.00	1.00	0.74	0.60	1.00	1.00	0.74	0.60								
	ΔT	21	19	16	12	21	19	16	12	21	19	16	12	21	19	16	12	21	19	15	12	22	20	16	13	22	20	16	13								
	kW	2.54	2.54	2.54	2.56	2.84	2.83	2.83	2.85	3.16	3.16	3.16	3.18	3.52	3.51	3.51	3.53	3.91	3.91	3.90	3.93	4.38	4.37	4.37	4.39	4.38	4.37	4.37	4.39								
	Amps	9.4	9.4	9.4	9.5	10.8	10.8	10.8	10.9	12.3	12.3	12.3	12.4	13.9	13.9	13.9	14.0	15.7	15.7	15.7	15.8	17.8	17.8	17.8	17.9	17.8	17.8	17.8	17.9								
	Hi-PR	248	249	251	255	286	287	289	293	326	327	329	333	369	370	372	376	416	417	418	423	465	466	468	472	465	466	468	472								
Lo-PR	124	126	129	134	132	133	136	141	138	139	142	148	143	145	148	153	149	150	153	158	155	157	160	165	155	157	160	165									

IDB: Entering Indoor Dry Bulb Temperature
 High and low pressures are measured at the liquid and suction service valves.
 Shaded area reflects ACCA (TVA) Rating Conditions.
 Amps = Outdoor unit amps (compressor + fan)
 kW = Total system power

COOLING DATA — DZ5SEA6010A* + AMST60DU1400A*

IDB		OUTDOOR AMBIENT TEMPERATURE												105°F												115°F											
		65°F						75°F						85°F						95°F						105°F						115°F					
		AIRFLOW		59	63	67	71	59		63	67	71	59		63	67	71	59		63	67	71	59		63	67	71	59		63	67	71					
70	1600	MBh	57.6	58.4	60.1	-	57.0	57.9	59.6	-	55.5	56.4	58.1	-	53.0	53.8	55.5	-	49.8	50.6	52.3	-	46.9	47.7	49.5	-	47.0	47.8	49.5	52.1							
		S/T	0.61	0.54	0.40	-	0.62	0.54	0.41	-	0.65	0.57	0.43	-	0.67	0.59	0.45	-	1.00	0.61	0.48	-	1.00	0.66	0.53	-	1.00	0.79	0.66	0.51							
		ΔT	19	18	14	-	19	18	14	-	20	18	14	-	19	18	14	-	19	17	14	-	20	18	15	-	24	22	19	16							
		kW	3.32	3.32	3.31	-	3.75	3.74	3.74	-	4.22	4.22	4.21	-	4.74	4.74	4.73	-	5.31	5.31	5.30	-	5.99	5.99	5.98	-	5.99	5.99	5.98	6.01							
		Amps	13.0	13.0	13.0	-	15.0	14.9	14.9	-	17.1	17.1	17.1	-	19.5	19.5	19.5	-	22.1	22.1	22.1	-	25.2	25.2	25.2	-	25.2	25.2	25.2	25.3							
		Hi/PR	242	243	245	-	280	281	283	-	320	321	323	-	363	364	366	-	410	411	413	-	459	460	462	-	460	461	462	464							
	Lo/PR	119	120	124	-	126	128	131	-	133	134	137	-	138	139	142	-	143	145	148	-	150	151	154	-	151	153	155	158								
	1800	MBh	58.2	59.0	60.8	-	57.7	58.5	60.3	-	56.2	57.0	58.8	-	53.6	54.5	56.2	-	50.5	51.3	53.0	-	47.6	48.4	50.1	-	48.4	49.2	50.9	-							
		S/T	0.67	0.59	0.45	-	0.67	0.60	0.46	-	0.70	0.62	0.49	-	0.72	0.64	0.51	-	1.00	0.66	0.53	-	1.00	0.71	0.58	-	1.00	0.84	0.71	0.57							
		ΔT	18	17	13	-	18	17	13	-	19	17	13	-	18	17	13	-	18	16	13	-	19	17	14	-	18	17	13	-							
		kW	3.34	3.34	3.33	-	3.77	3.76	3.76	-	4.24	4.24	4.23	-	4.76	4.75	4.75	-	5.33	5.33	5.32	-	6.01	6.00	6.00	-	6.02	6.02	6.01	-							
		Amps	13.1	13.1	13.1	-	15.1	15.0	15.0	-	17.2	17.2	17.2	-	19.6	19.6	19.5	-	22.2	22.2	22.2	-	25.3	25.3	25.3	-	25.4	25.4	25.3	-							
Hi/PR		244	245	247	-	282	283	285	-	322	323	325	-	365	366	368	-	412	413	414	-	461	462	464	-	463	464	466	-								
Lo/PR	121	122	125	-	128	129	132	-	134	136	139	-	139	141	144	-	145	146	149	-	151	153	156	-	153	155	158	-									
2000	MBh	59.0	59.8	61.6	-	58.5	59.3	61.0	-	57.0	57.8	59.5	-	54.4	55.2	57.0	-	51.3	52.1	53.8	-	48.4	49.2	50.9	-	48.4	49.2	50.9	-								
	S/T	0.70	0.62	0.49	-	0.70	0.63	0.49	-	0.73	0.65	0.52	-	0.75	0.67	0.54	-	1.00	0.69	0.56	-	1.00	0.75	0.61	-	1.00	0.84	0.71	0.57								
	ΔT	18	16	12	-	18	16	12	-	18	16	13	-	18	16	12	-	17	16	12	-	18	17	13	-	18	17	13	-								
	kW	3.36	3.35	3.35	-	3.78	3.78	3.77	-	4.26	4.26	4.25	-	4.77	4.77	4.76	-	5.35	5.35	5.34	-	6.02	6.02	6.01	-	6.02	6.02	6.01	-								
	Amps	13.2	13.2	13.1	-	15.1	15.1	15.1	-	17.3	17.3	17.3	-	19.7	19.6	19.6	-	22.3	22.3	22.2	-	25.4	25.4	25.3	-	25.4	25.4	25.3	-								
	Hi/PR	246	247	248	-	284	285	287	-	324	325	327	-	367	368	370	-	413	414	416	-	463	464	466	-	463	464	466	-								
Lo/PR	122	124	127	-	130	131	134	-	136	137	140	-	141	143	146	-	146	148	151	-	153	155	158	-	153	155	158	-									
75	1600	MBh	57.6	58.4	60.1	62.7	57.1	57.9	59.6	62.2	55.6	56.4	58.1	60.7	53.0	53.8	55.5	58.1	49.8	50.7	52.4	55.0	47.0	47.8	49.5	52.1											
		S/T	0.74	0.67	0.53	0.39	0.75	0.67	0.54	0.40	0.78	0.70	0.56	0.42	1.00	0.72	0.58	0.44	1.00	0.74	0.60	0.46	1.00	0.79	0.66	0.51											
		ΔT	23	22	18	15	23	22	18	15	24	22	18	15	23	22	18	15	23	21	18	14	24	22	19	16											
		kW	3.32	3.32	3.31	3.34	3.75	3.74	3.73	3.77	4.22	4.22	4.21	4.24	4.74	4.73	4.73	4.76	5.31	5.31	5.30	5.33	5.99	5.98	5.98	6.01											
		Amps	13.0	13.0	13.0	13.1	15.0	14.9	14.9	15.1	17.1	17.1	17.1	17.2	19.5	19.5	19.4	19.6	22.1	22.1	22.1	22.2	25.2	25.2	25.2	25.3											
		Hi/PR	242	243	245	249	281	282	283	287	321	322	323	327	364	365	366	371	410	411	413	417	460	461	462	467											
	Lo/PR	119	121	124	129	126	128	131	136	133	134	137	142	138	139	142	148	143	145	148	153	150	151	154	159												
	1800	MBh	58.3	59.1	60.8	63.4	57.8	58.6	60.3	62.9	56.3	57.1	58.8	61.4	53.7	54.5	56.2	58.8	50.5	51.3	53.0	55.7	47.6	48.4	50.2	52.8											
		S/T	0.80	0.72	0.58	0.44	0.80	0.73	0.59	0.45	1.00	0.75	0.62	0.47	1.00	0.77	0.63	0.49	1.00	0.79	0.66	0.51	1.00	0.84	0.71	0.57											
		ΔT	22	21	17	14	22	21	17	14	23	21	17	14	22	21	17	14	22	20	17	13	23	21	18	15											
		kW	3.34	3.33	3.33	3.36	3.76	3.76	3.75	3.79	4.24	4.24	4.23	4.26	4.76	4.75	4.74	4.78	5.33	5.33	5.32	5.35	6.01	6.00	5.99	6.03											
		Amps	13.1	13.1	13.0	13.2	15.0	15.0	15.0	15.1	17.2	17.2	17.2	17.3	19.6	19.6	19.5	19.7	22.2	22.2	22.2	22.3	25.3	25.3	25.2	25.4											
Hi/PR		244	245	247	251	282	283	285	289	322	323	325	329	365	366	368	372	412	413	415	419	461	462	464	468												
Lo/PR	121	122	125	130	128	129	132	137	134	136	139	144	140	141	144	149	145	146	149	154	151	153	156	161													
2000	MBh	59.1	59.9	61.6	64.2	58.6	59.4	61.1	63.7	57.1	57.9	59.6	62.2	54.5	55.3	57.0	59.6	51.3	52.1	53.8	56.5	48.4	49.2	51.0	53.6												
	S/T	0.83	0.75	0.62	0.47	0.83	0.76	0.62	0.48	1.00	0.78	0.65	0.50	1.00	0.80	0.67	0.52	1.00	0.82	0.69	0.55	1.00	0.88	0.74	0.60												
	ΔT	22	20	16	13	22	20	16	13	22	20	17	13	22	20	16	13	21	20	16	13	22	21	17	14												
	kW	3.35	3.35	3.34	3.38	3.78	3.78	3.77	3.80	4.26	4.25	4.25	4.28	4.77	4.77	4.76	4.79	5.35	5.34	5.34	5.37	6.02	6.02	6.01	6.04												
	Amps	13.2	13.2	13.1	13.3	15.1	15.1	15.1	15.2	17.3	17.3	17.3	17.4	19.7	19.6	19.6	19.8	22.3	22.3	22.2	22.4	25.4	25.4	25.3	25.5												
	Hi/PR	246	247	249	253	284	285	287	291	324	325	327	331	367	368	370	374	414	415	416	421	463	464	466	470												
Lo/PR	122	124	127	132	130	131	134	139	136	137	140	145	141	143	146	151	146	148	151	156	153	155	158	163													

IDB: Entering Indoor Dry Bulb Temperature
 High and low pressures are measured at the liquid and suction service valves.
 Shaded area reflects ACCA (TVA) Rating Conditions.
 kW = Total system power
 Amps = Outdoor unit amps (compressor + fan)

COOLING DATA — DZ5SEA6010A* + AMST60DU1400A* (CONT.)

IDB		OUTDOOR AMBIENT TEMPERATURE																											
		65°F				75°F				85°F				95°F				105°F				115°F							
		59	63	67	71	59	63	67	71	59	63	67	71	59	63	67	71	59	63	67	71	59	63	67	71				
AIRFLOW		59	63	67	71	59	63	67	71	59	63	67	71	59	63	67	71	59	63	67	71	59	63	67	71	59	63	67	71
		ENTERING INDOOR WET BULB TEMPERATURE																											
		ENTERING INDOOR WET BULB TEMPERATURE																											
80	1600	MBh	57.9	58.7	60.4	63.0	57.4	58.2	59.9	62.5	55.9	56.7	58.4	61.0	53.3	54.1	55.8	58.4	50.1	50.9	52.7	55.3	47.3	48.1	49.8	52.4			
		S/T	0.87	0.79	0.66	0.51	1.00	0.80	0.66	0.52	1.00	0.82	0.69	0.55	1.00	0.84	0.71	0.57	1.00	0.87	0.73	0.59	1.00	1.00	0.78	0.64			
		ΔT	27	26	22	19	27	26	22	19	28	26	22	19	27	26	22	19	27	25	22	18	28	26	23	20			
		kW	3.32	3.32	3.31	3.34	3.75	3.74	3.74	3.77	4.22	4.22	4.21	4.25	4.74	4.73	4.73	4.76	5.31	5.31	5.30	5.34	5.99	5.98	5.98	6.01			
		Amps	13.0	13.0	13.0	13.1	15.0	14.9	14.9	15.1	17.1	17.1	17.1	17.2	19.5	19.5	19.4	19.6	22.1	22.1	22.1	22.2	25.2	25.2	25.2	25.3			
		Hi PR	243	244	246	250	281	282	284	288	321	322	324	328	364	365	367	371	410	412	413	417	460	461	463	467			
		Lo PR	120	121	124	129	127	128	131	136	133	135	138	143	138	140	143	148	144	145	148	153	150	152	155	160			
		1800	MBh	58.6	59.4	61.1	63.7	58.1	58.9	60.6	63.2	56.6	57.4	59.1	61.7	54.0	54.8	56.5	59.1	50.8	51.6	53.3	56.0	47.9	48.7	50.5	53.1		
			S/T	0.92	0.85	0.71	0.57	1.00	0.85	0.72	0.57	1.00	0.88	0.74	0.60	1.00	0.90	0.76	0.62	1.00	1.00	0.78	0.64	1.00	1.00	0.83	0.69		
			ΔT	26	25	21	18	26	25	21	18	27	25	21	18	26	25	21	18	26	24	21	17	27	25	22	19		
		kW	3.34	3.34	3.33	3.36	3.77	3.76	3.76	3.79	4.24	4.24	4.23	4.26	4.76	4.75	4.75	4.78	5.33	5.33	5.32	5.35	6.01	6.00	6.00	6.03			
		Amps	13.1	13.1	13.1	13.2	15.1	15.0	15.0	15.2	17.2	17.2	17.2	17.3	19.6	19.6	19.5	19.7	22.2	22.2	22.2	22.3	25.3	25.3	25.3	25.4			
		Hi PR	245	246	247	252	283	284	286	290	323	324	326	330	366	367	369	373	412	413	415	419	462	463	465	469			
		Lo PR	121	123	126	131	128	130	133	138	135	136	139	144	140	142	145	150	145	147	150	155	152	153	156	161			
	2000	MBh	59.4	60.2	61.9	64.5	58.9	59.7	61.4	64.0	57.4	58.2	59.9	62.5	54.8	55.6	57.3	59.9	51.6	52.4	54.1	56.8	48.7	49.5	51.3	53.9			
		S/T	1.00	0.88	0.74	0.60	1.00	0.88	0.75	0.60	1.00	0.91	0.77	0.63	1.00	0.93	0.79	0.65	1.00	1.00	0.81	0.67	1.00	1.00	0.87	0.72			
		ΔT	26	24	20	17	26	24	20	17	26	24	21	17	26	24	20	17	25	24	20	17	26	25	21	18			
		kW	3.36	3.35	3.35	3.38	3.78	3.78	3.77	3.81	4.26	4.26	4.25	4.28	4.77	4.77	4.76	4.80	5.35	5.35	5.34	5.37	6.02	6.02	6.01	6.05			
		Amps	13.2	13.2	13.1	13.3	15.1	15.1	15.1	15.2	17.3	17.3	17.3	17.4	19.7	19.6	19.6	19.8	22.3	22.3	22.2	22.4	25.4	25.4	25.3	25.5			
		Hi PR	246	247	249	253	285	286	287	292	325	326	327	332	368	369	370	375	414	415	417	421	464	465	466	471			
		Lo PR	123	124	127	132	130	132	135	140	136	138	141	146	142	143	146	151	147	148	152	157	154	155	158	163			
85	1600	MBh	58.9	59.7	61.4	64.0	58.3	59.2	60.9	63.5	56.8	57.7	59.4	62.0	54.3	55.1	56.8	59.4	51.1	51.9	53.6	56.3	48.2	49.0	50.8	53.4			
		S/T	1.00	0.89	0.76	0.6	1.00	0.90	0.77	0.6	1.00	1.00	0.79	0.6	1.00	1.00	0.81	0.7	1.00	1.00	0.83	0.7	1.00	1.00	0.88	0.7			
		ΔT	31	29	26	22	31	29	26	22	31	29	26	22	31	29	26	22	31	29	25	22	32	30	27	23			
		kW	3.33	3.33	3.32	3.4	3.76	3.75	3.74	3.8	4.23	4.23	4.22	4.3	4.75	4.74	4.74	4.8	5.32	5.32	5.31	5.3	6.00	5.99	5.99	6.0			
		Amps	13.0	13.0	13.0	13.1	15.0	15.0	15.0	15.1	17.2	17.2	17.1	17.3	19.5	19.5	19.5	19.6	22.2	22.2	22.1	22.3	25.3	25.2	25.2	25.4			
		Hi PR	244	245	247	251	282	283	285	289	322	323	325	329	365	366	368	372	412	413	414	419	461	462	464	468			
		Lo PR	121	123	126	131	129	130	133	138	135	136	139	144	140	142	145	150	146	147	150	155	152	154	157	162			
		1800	MBh	59.5	60.3	62.1	64.7	59.0	59.8	61.6	64.2	57.5	58.3	60.1	62.7	54.9	55.8	57.5	60.1	51.8	52.6	54.3	56.9	48.9	49.7	51.4	54.1		
			S/T	1.00	0.95	0.81	0.7	1.00	0.95	0.82	0.7	1.00	1.00	0.84	0.7	1.00	1.00	0.86	0.7	1.00	1.00	0.88	0.7	1.00	1.00	0.94	0.8		
			ΔT	30	28	25	21	30	28	25	21	30	28	25	22	30	28	25	21	30	28	25	21	31	29	26	22		
		kW	3.35	3.35	3.34	3.4	3.77	3.77	3.76	3.8	4.25	4.25	4.24	4.3	4.77	4.76	4.75	4.8	5.34	5.34	5.33	5.4	6.02	6.01	6.01	6.0			
		Amps	13.1	13.1	13.1	13.2	15.1	15.1	15.0	15.2	17.3	17.3	17.2	17.4	19.6	19.6	19.6	19.7	22.3	22.2	22.2	22.4	25.3	25.3	25.3	25.4			
		Hi PR	246	247	249	253	284	285	287	291	324	325	327	331	367	368	370	374	413	414	416	420	463	464	466	470			
		Lo PR	123	124	127	132	130	132	135	140	136	138	141	146	142	143	146	151	147	149	152	157	154	155	158	163			
	2000	MBh	60.3	61.1	62.9	65.5	59.8	60.6	62.3	65.0	58.3	59.1	60.8	63.5	55.7	56.5	58.3	60.9	52.6	53.4	55.1	57.7	49.7	50.5	52.2	54.9			
		S/T	1.00	0.98	0.84	0.7	1.00	0.98	0.85	0.7	1.00	1.00	0.87	0.7	1.00	1.00	0.89	0.7	1.00	1.00	0.92	0.8	1.00	1.00	1.00	0.8			
		ΔT	29	27	24	21	29	27	24	20	29	28	24	21	29	27	24	20	29	27	24	20	30	28	25	21			
		kW	3.37	3.36	3.35	3.4	3.79	3.79	3.78	3.8	4.27	4.26	4.26	4.3	4.78	4.78	4.77	4.8	5.36	5.35	5.35	5.4	6.03	6.03	6.02	6.1			
		Amps	13.2	13.2	13.2	13.3	15.2	15.1	15.1	15.3	17.3	17.3	17.3	17.4	19.7	19.7	19.7	19.8	22.3	22.3	22.3	22.4	25.4	25.4	25.4	25.5			
		Hi PR	248	249	250	254	286	287	288	293	326	327	328	333	369	370	372	376	415	416	418	422	465	466	467	472			
		Lo PR	125	126	129	134	132	133	136	141	138	140	143	148	144	145	148	153	149	150	153	158	155	157	160	165			

Shaded area reflects AHRI Rating Conditions.

IDB: Entering Indoor Dry Bulb Temperature
High and low pressures are measured at the liquid and suction service valves.

kW = Total system power
Amps = Outdoor unit amps (compressor + fan)

EXPANDED HEATING DATA

DZ5SEA1810A*+AMST30BU1400A*

	OUTDOOR AMBIENT TEMPERATURE																
	65	60	55	50	47	45	40	35	30	25	20	17	15	10	5	0	-5
MBh	22.7	21.2	19.8	18.3	17.4	16.7	15.0	13.4	12.1	11.1	10.4	10.0	9.5	8.3	7.0	5.8	4.6
T/R	32.6	30.8	28.9	27.1	26.0	25.0	22.4	20.0	18.0	16.6	15.5	14.9	14.2	12.4	10.5	8.7	6.8
KW	1.4	1.4	1.3	1.3	1.3	1.3	1.3	1.3	1.2	1.2	1.2	1.2	1.2	1.1	1.1	1.1	1.1
AMPS	5.1	5.0	4.9	4.8	4.7	4.7	4.6	4.5	4.4	4.3	4.2	4.1	4.1	4.0	3.9	3.8	3.7
COP	4.79	4.55	4.31	4.06	3.90	3.77	3.44	3.13	2.88	2.69	2.57	2.50	2.40	2.13	1.85	1.55	1.25
Hi PR	363	351	339	327	320	315	304	292	280	268	257	249	245	233	221	209	198
LO PR	148	139	130	121	115	111	102	93	84	74	65	60	56	47	38	28	19

DZ5SEA2410A*+AMST30BU1400A*

	OUTDOOR AMBIENT TEMPERATURE																
	65	60	55	50	47	45	40	35	30	25	20	17	15	10	5	0	-5
MBh	30.5	28.4	26.4	24.5	23.2	22.2	19.8	17.7	15.9	14.5	13.5	13.0	12.3	10.6	8.9	7.2	5.5
T/R	33.9	32.0	30.0	28.0	26.9	25.7	23.0	20.4	18.4	16.8	15.7	15.0	14.3	12.3	10.3	8.4	6.4
KW	2.0	2.0	1.9	1.9	1.8	1.8	1.7	1.7	1.7	1.6	1.6	1.5	1.5	1.5	1.4	1.3	1.3
AMPS	7.5	7.3	7.1	6.9	6.7	6.6	6.4	6.2	5.9	5.7	5.5	5.4	5.3	5.0	4.8	4.6	4.4
COP	4.41	4.22	4.03	3.84	3.70	3.59	3.30	3.02	2.80	2.65	2.55	2.50	2.40	2.15	1.87	1.57	1.25
Hi PR	377	365	353	340	333	328	316	304	291	279	267	259	254	242	230	218	205
LO PR	142	133	124	116	110	107	98	89	80	71	62	57	54	45	36	27	18

DZ5SEA3010A*+AMST30BU1400A*

	OUTDOOR AMBIENT TEMPERATURE																
	65	60	55	50	47	45	40	35	30	25	20	17	15	10	5	0	-5
MBh	36.4	34.2	32.0	29.8	28.4	27.4	24.8	22.4	20.5	19.0	18.0	17.4	16.7	14.8	13.0	11.2	9.3
T/R	32.4	30.7	29.0	27.3	26.3	25.4	23.0	20.8	18.9	17.6	16.6	16.1	15.4	13.7	12.0	10.3	8.6
KW	2.4	2.3	2.3	2.3	2.2	2.2	2.2	2.2	2.1	2.1	2.1	2.0	2.0	2.0	2.0	1.9	1.9
AMPS	8.7	8.6	8.4	8.3	8.2	8.1	8.0	7.8	7.7	7.5	7.4	7.3	7.2	7.1	6.9	6.8	6.6
COP	4.49	4.28	4.06	3.85	3.70	3.59	3.31	3.04	2.81	2.66	2.56	2.50	2.41	2.18	1.95	1.70	1.45
Hi PR	385	373	360	348	340	335	323	310	298	285	273	265	260	248	235	222	210
LO PR	137	129	120	112	107	103	95	86	77	69	60	55	52	43	35	26	18

DZ5SEA3610A*+AMST42CU1400A*

	OUTDOOR AMBIENT TEMPERATURE																
	65	60	55	50	47	45	40	35	30	25	20	17	15	10	5	0	-5
MBh	44.8	41.9	39.0	36.2	34.4	33.1	29.7	26.6	24.0	22.1	20.8	20.0	19.0	16.6	14.2	11.8	9.4
T/R	36.9	34.8	32.8	30.7	29.5	28.4	25.5	22.8	20.6	19.0	17.8	17.1	16.3	14.3	12.2	10.1	8.1
KW	3.1	3.1	3.0	2.9	2.9	2.9	2.8	2.7	2.6	2.6	2.5	2.4	2.4	2.3	2.3	2.2	2.1
AMPS	12.0	11.6	11.3	11.0	10.8	10.7	10.4	10.0	9.7	9.4	9.1	8.9	8.8	8.5	8.1	7.8	7.5
COP	4.17	4.00	3.81	3.63	3.50	3.40	3.13	2.88	2.68	2.54	2.45	2.40	2.31	2.08	1.84	1.58	1.30
Hi PR	397	384	371	358	351	345	332	320	307	294	281	273	268	255	242	229	216
LO PR	133	125	117	108	104	100	92	84	75	67	59	54	50	42	34	26	17

DZ5SEA4210A*+AMST42CU1400A*

	OUTDOOR AMBIENT TEMPERATURE																
	65	60	55	50	47	45	40	35	30	25	20	17	15	10	5	0	-5
MBh	51.6	48.3	45.2	42.0	40.0	38.5	34.8	31.3	28.5	26.4	24.8	24.0	22.9	20.3	17.6	14.9	12.3
T/R	34.3	32.4	30.6	28.7	27.6	26.6	24.0	21.6	19.7	18.2	17.2	16.6	15.8	14.0	12.2	10.3	8.5
KW	3.5	3.4	3.3	3.3	3.3	3.2	3.2	3.1	3.1	3.0	3.0	2.9	2.9	2.9	2.8	2.7	2.7
AMPS	12.9	12.6	12.4	12.2	12.0	11.9	11.7	11.5	11.2	11.0	10.8	10.6	10.5	10.3	10.0	9.8	9.6
COP	4.38	4.17	3.96	3.74	3.60	3.49	3.21	2.94	2.72	2.56	2.46	2.40	2.31	2.08	1.84	1.59	1.34
Hi PR	395	382	369	356	348	343	330	318	305	292	279	271	266	253	241	228	215
LO PR	132	124	115	107	102	99	91	83	74	66	58	53	50	42	33	25	17

DZ5SEA4810A*+AMST48CU1400A*

	OUTDOOR AMBIENT TEMPERATURE																
	65	60	55	50	47	45	40	35	30	25	20	17	15	10	5	0	-5
MBh	59.1	55.4	51.8	48.3	46.0	44.4	40.2	36.2	33.0	30.7	28.9	28.0	26.8	23.8	20.8	17.8	14.8
T/R	36.0	34.1	32.2	30.3	29.2	28.1	25.5	23.0	20.9	19.4	18.3	17.8	17.0	15.1	13.2	11.3	9.4
KW	3.9	3.8	3.7	3.7	3.6	3.6	3.6	3.5	3.4	3.4	3.3	3.3	3.3	3.2	3.1	3.1	3.0
AMPS	14.5	14.2	13.9	13.7	13.5	13.4	13.2	12.9	12.6	12.4	12.1	12.0	11.9	11.6	11.3	11.1	10.8
COP	4.48	4.27	4.06	3.85	3.70	3.59	3.31	3.03	2.81	2.66	2.55	2.50	2.41	2.18	1.94	1.69	1.44
Hi PR	433	419	405	391	382	376	362	348	334	320	306	298	292	278	264	250	236
LO PR	137	128	120	111	106	103	94	86	77	69	60	55	52	43	35	26	18

DZ5SEA6010A*+AMST60DU1400A*

	OUTDOOR AMBIENT TEMPERATURE																
	65	60	55	50	47	45	40	35	30	25	20	17	15	10	5	0	-5
MBh	71.1	67.2	63.3	59.5	57.0	55.2	51.0	46.4	43.2	40.7	38.9	38.0	36.7	33.6	30.4	27.2	24.1
T/R	35.4	33.7	32.1	30.5	29.5	28.6	26.4	24.2	22.4	21.1	20.1	19.7	19.0	17.4	15.7	14.1	12.4
KW	4.7	4.7	4.6	4.6	4.5	4.5	4.4	4.4	4.3	4.2	4.2	4.1	4.1	4.0	4.0	3.9	3.8
AMPS	17.8	17.5	17.2	17.0	16.8	16.7	16.4	16.1	15.8	15.5	15.3	15.1	15.0	14.7	14.4	14.1	13.8
COP	4.39	4.20	4.02	3.83	3.70	3.60	3.38	3.12	2.95	2.82	2.74	2.70	2.63	2.44	2.24	2.04	1.84
Hi PR	427	413	400	386	377	372	358	344	330	316	302	294	288	274	261	247	233
LO PR	130	122	114	105	101	97	89	81	73	65	57	52	49	41	33	25	17

Shaded area is AHRI Rating Conditions at 47 degree F outdoor ambient temperature

Amps = Outdoor unit amps (comp.+fan)

kW = Total system power

Daikin Manufacturing Company, L.P. reserves the right to discontinue, or change at any time, specifications or designs without notice or without incurring obligations.

PERFORMANCE DATA

DZ5SEA1810A* + AMST30BU1400A*				
CONDITIONS: 80 °F IBD, 67 °F IWB @ 620 CFM				
OUTDOOR TEM. ° F.	TOTAL BTU/H	SENSIBLE BTU/H	LATENT BTU/H	TOTAL WATTS
75	18,850	13,650	5,200	1,100
80	18,650	13,750	4,900	1,160
85	18,400	13,800	4,600	1,220
90	18,000	13,650	4,350	1,290
95	17,600	13,500	4,100	1,350
100	17,100	13,350	3,750	1,430
105	16,600	13,150	3,450	1,500
110	16,150	13,200	2,950	1,590
115	15,700	13,250	2,450	1,670
TVA CONDITIONS @ 95° OD DB, 75° ID DB 63° ID WB				
95°	16,950	13,200	3,750	1,350

DZ5SEA2410A* + AMST30BU1400A*				
CONDITIONS: 80 °F IBD, 67 °F IWB @ 800 CFM				
OUTDOOR TEM. ° F.	TOTAL BTU/H	SENSIBLE BTU/H	LATENT BTU/H	TOTAL WATTS
75	24,900	17,950	6,950	1,440
80	24,600	18,050	6,550	1,530
85	24,250	18,150	6,100	1,610
90	23,750	18,000	5,750	1,700
95	23,200	17,800	5,400	1,780
100	22,550	17,550	5,000	1,880
105	21,900	17,300	4,600	1,980
110	21,300	17,400	3,900	2,100
115	20,700	17,450	3,250	2,210
TVA CONDITIONS @ 95° OD DB, 75° ID DB 63° ID WB				
95°	22,350	17,400	4,950	1,780

DZ5SEA3010A* + AMST30BU1400A*				
CONDITIONS: 80 °F IBD, 67 °F IWB @ 1000 CFM				
OUTDOOR TEM. ° F.	TOTAL BTU/H	SENSIBLE BTU/H	LATENT BTU/H	TOTAL WATTS
75	30,450	22,350	8,100	1,820
80	30,100	22,450	7,650	1,920
85	29,700	22,550	7,150	2,020
90	29,050	22,350	6,700	2,140
95	28,400	22,150	6,250	2,250
100	27,600	21,850	5,750	2,380
105	26,800	21,500	5,300	2,500
110	26,100	21,600	4,500	2,650
115	25,350	21,700	3,650	2,790
TVA CONDITIONS @ 95° OD DB, 75° ID DB 63° ID WB				
95°	27,400	21,650	5,750	2,250

DZ5SEA3610A* + AMST42CU1400A*				
CONDITIONS: 80 °F IBD, 67 °F IWB @ 1200 CFM				
OUTDOOR TEM. ° F.	TOTAL BTU/H	SENSIBLE BTU/H	LATENT BTU/H	TOTAL WATTS
75	37,800	27,300	10,500	2,170
80	37,350	27,450	9,900	2,310
85	36,900	27,550	9,350	2,440
90	36,100	27,300	8,800	2,590
95	35,300	27,000	8,300	2,730
100	34,350	26,650	7,700	2,890
105	33,350	26,250	7,100	3,050
110	32,450	26,350	6,100	3,240
115	31,550	26,400	5,150	3,430
TVA CONDITIONS @ 95° OD DB, 75° ID DB 63° ID WB				
95°	34,050	26,400	7,650	2,730

DZ5SEA4210A* + AMST42CU1400A*				
CONDITIONS: 80 °F IBD, 67 °F IWB @ 1340 CFM				
OUTDOOR TEM. ° F.	TOTAL BTU/H	SENSIBLE BTU/H	LATENT BTU/H	TOTAL WATTS
75	42,900	30,850	12,050	2,500
80	42,400	31,000	11,400	2,640
85	41,850	31,150	10,700	2,780
90	40,950	30,850	10,100	2,940
95	40,000	30,550	9,450	3,090
100	38,900	30,150	8,750	3,260
105	37,750	29,700	8,050	3,430
110	36,750	29,850	6,900	3,630
115	35,750	29,950	5,800	3,830
TVA CONDITIONS @ 95° OD DB, 75° ID DB 63° ID WB				
95°	38,550	29,850	8,700	3,090

DZ5SEA4810A* + AMST48CU1400A*				
CONDITIONS: 80 °F IBD, 67 °F IWB @ 1600 CFM				
OUTDOOR TEM. ° F.	TOTAL BTU/H	SENSIBLE BTU/H	LATENT BTU/H	TOTAL WATTS
75	49,350	35,900	13,450	2,820
80	48,750	36,050	12,700	2,980
85	48,150	36,200	11,950	3,140
90	47,100	35,850	11,250	3,320
95	46,050	35,500	10,550	3,500
100	44,800	35,000	9,800	3,700
105	43,500	34,450	9,050	3,890
110	42,350	34,600	7,750	4,130
115	41,200	34,700	6,500	4,360
TVA CONDITIONS @ 95° OD DB, 75° ID DB 63° ID WB				
95°	44,450	34,700	9,750	3,500

DZ5SEA6010A* + AMST60DU1400A*				
CONDITIONS: 80 °F IBD, 67 °F IWB @ 1800 CFM				
"OUTDOOR TEM. ° F."	"TOTAL BTU/H"	"SENSIBLE BTU/H"	"LATENT BTU/H"	"TOTAL WATTS"
75	60,600	43,350	17,250	3,760
80	59,850	43,550	16,300	4,000
85	59,100	43,750	15,350	4,230
90	57,800	43,350	14,450	4,490
95	56,500	42,950	13,550	4,750
100	54,950	42,350	12,600	5,040
105	53,350	41,750	11,600	5,320
110	51,900	41,950	9,950	5,660
115	50,450	42,100	8,350	6,000
TVA Conditions @ 95° OD DB, 75° ID DB 63° ID WB				
95°	54,500	42,000	12,500	4,750

ALL AHRI SYSTEM RATINGS ARE ACCESSIBLE IN THE UNITARY MATCHUP TOOL VIA DAIKIN CITY OR IN THE DAIKIN SYSTEM CONFIGURATOR TOOL VIA PARTNERLINK.

DIMENSIONS

MODEL	DIMENSIONS		
	W"	D"	H"
DZ5SEA1810A*	29	29	39½
DZ5SEA2410A*	35½	35½	35½
DZ5SEA3010A*	35½	35½	39½
DZ5SEA3610A*	35½	35½	39½
DZ5SEA4210A*	35½	35½	35½
DZ5SEA4810A*	35½	35½	36½
DZ5SEA6010A*	35½	35½	41½

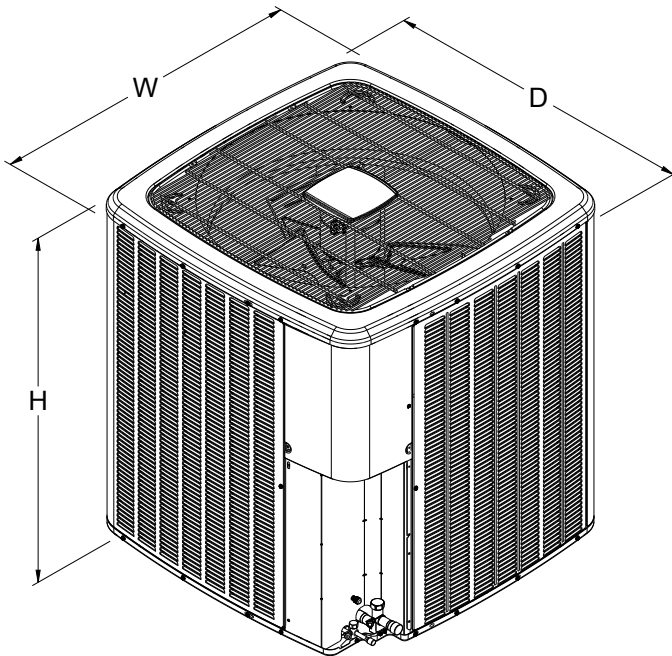

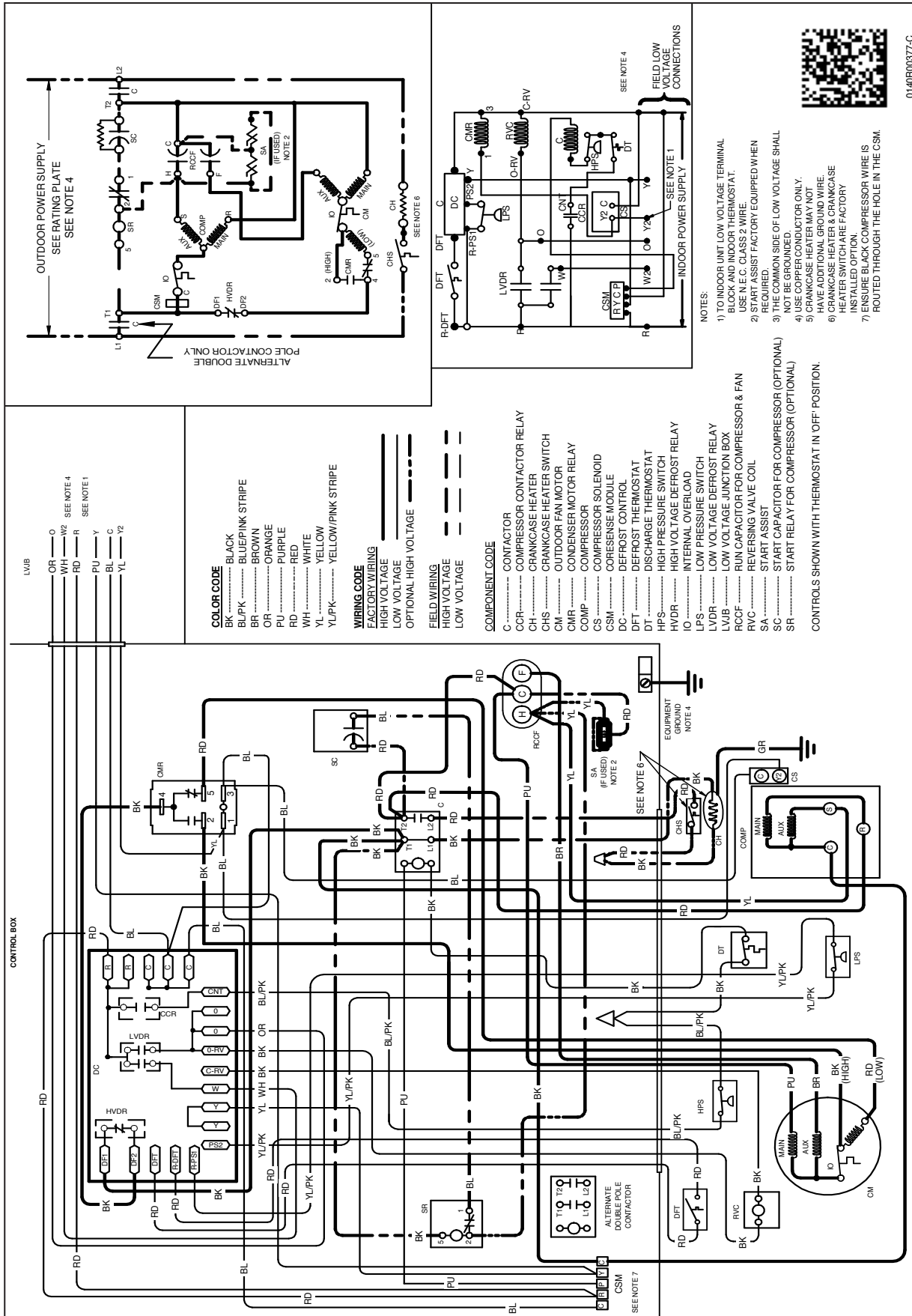

0140R00377-C

WARNING

High Voltage: Disconnect all power before servicing or installing this unit. Multiple power sources may be present. Failure to do so may cause property damage, personal injury, or death.

Wiring is subject to change. Always refer to the wiring diagram on the unit for the most up-to-date wiring.

ACCESSORIES

MODEL #	DESCRIPTION	DZ5SEA 1810A*	DZ5SEA 2410A*	DZ5SEA 3010A*	DZ5SEA 3610A*	DZ5SEA 4210A*	DZ5SEA 4810A*	DZ5SEA 6010A*
ABK-20	Anchor Bracket Kit [◊]	X	X	X	X	X	X	X
CSR-U-1	Hard-start Kit	X	X	X	X			
CSR-U-2	Hard-start Kit					X	X	X
CSR-U-3	Hard-start Kit						X	X
FSK01A ¹	Freeze Protection Kit	X	X	X	X	X	X	X
LAKT01A	Low-Ambient Kit	X	X	X		X	X	X
OT18-60A ²	Outdoor Thermostat w/ Lockout Stat	X	X	X	X	X	X	X
TXV-FX-KX-2T ³	TXV Kit	X	X					
TXV-FX-KX-3T ³	TXV Kit			X	X			
TXV-FX-KX-5T ³	TXV Kit					X	X	X

◊ Contains 20 brackets; four brackets needed to anchor unit to pad

¹ Installed on indoor coil

² Required for heat pump applications where ambient temperatures fall below 0°F with 50% or higher relative humidity.

³ Condensing units and heat pumps with reciprocating or rotary compressors require the use of start-assist components when used in conjunction with an indoor coil using a non-bleed thermal expansion valve refrigerant metering device or liquid line solenoid kit. The TXV should always be sized based on the tonnage of the outdoor unit.

