



 **HERO**
CLOUD SERVICES

Off-site monitoring and control of your HVAC system investment. Identifies and recommends maintenance solutions. Adjusts your system to help optimize comfort and energy savings.



Daikin HERO Cloud Services

Daikin HERO Cloud Services is a remote monitoring and system control service for Daikin HVAC systems* and connected ancillary equipment**. When the HERO Cloud Services are integrated with the HVAC system, users have the ability to visualize system data and operation status of connected HVAC equipment using animated piping diagrams. Daikin HERO Cloud Services also include predictive logic alerting users of potential compressor and refrigerant leaks in Daikin VRV systems.

* Compatible with select models. Please visit daikincomfort.com to learn more.

** Ancillary equipment: pumps, boilers, fans, lighting, etc. can be connected via WAGO® or the BACnet™ protocol

Elevate control through remote monitoring:

- » **Time and cost-saving opportunities** – Helps reduce unnecessary truck rolls and expands awareness of potential system issues.
- » **An owner-oriented design with a customizable dashboard** – Provides a quick overview of all connected sites, Daikin HVAC systems, and ancillary equipment.

Daikin HERO Cloud Services is based upon a recurring licensing fee to access site information. Licenses can be purchased in 1-year, 3-year, or 5-year increment and first-year access is included with the purchase of the HERO Simple Edge or HERO Pro Edge hardware.



Daikin HERO Cloud Services monitor your Daikin HVAC systems and connected ancillary equipment 24/7, to help optimize system operation.

- » Remote monitoring to help manage and diagnose system performance.
- » Uses predictive logic to notify of impending failures.
- » Visualize system performance through the integrated dashboard from a web browser or the Daikin HERO Cloud Services App.
- » Streamline service and maintenance for each site.
- » The Daikin HERO Simple Edge offers a secure cellular communication to the Daikin HERO Cloud Services using a built-in SIM card.
- » The Daikin HERO Pro Edge can be connected to the internet via the building's Ethernet network. An optional LTE router can also be used for communication to the Daikin HERO Cloud Services as an alternative to using the building Ethernet network.



Daikin HERO Simple Edge



Daikin HERO Pro Edge

The Daikin HERO Cloud Services can offer advantages for building owners, contractors, and Daikin representatives:

Building Owners

- » Peace of mind
- » Remote monitoring and control
- » Multisite access
- » Intuitive user interface

Daikin Representatives

- » Remote access to all buildings in your territory
- » Continuous commissioning
- » Provide a service solution to the end-user
- » Commissioning reports, maintenance check and system health check

Contractors

- » Remotely diagnose technical issues
- » Easy troubleshooting using multiple tools, live data, graphs, history trends, alarm console, etc.
- » Error prediction and notifications

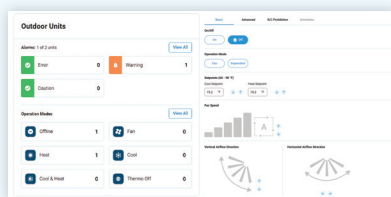

Remote monitoring and control anytime, from anywhere

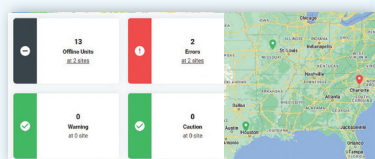

Multisite access and map view

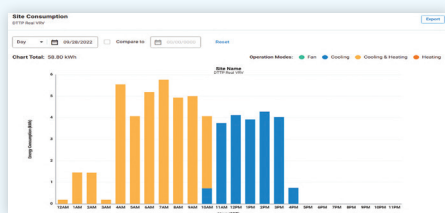

Energy Consumption

- **Monitor and control** your building no matter where you are
- **Manage multiple sites**
- **Visualize energy consumption and benchmark** between different sites to help reduce energy costs
- **Remote diagnostic support** to help increase your systems lifetime
- **Predictive maintenance** to alert of potential breakdowns
- **Remote troubleshooting** in case of malfunctions

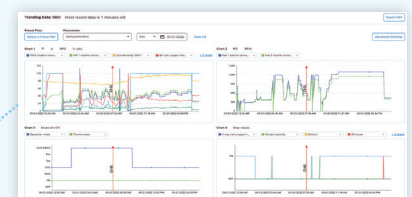

Trending and report generation

Unit	System	Capacity (kW)	Model	Status	Alarm	Message	Time
001	Office	10	FXS1000	Normal	OK		
002	Office	10	FXS1000	Warning	High Temp	High Temp	2023-10-27 10:00
003	Office	10	FXS1000	Caution	Low Pressure	Low Pressure	2023-10-27 09:30
004	Office	10	FXS1000	Normal	OK		
005	Office	10	FXS1000	Normal	OK		
006	Office	10	FXS1000	Normal	OK		
007	Office	10	FXS1000	Normal	OK		
008	Office	10	FXS1000	Normal	OK		
009	Office	10	FXS1000	Normal	OK		
010	Office	10	FXS1000	Normal	OK		

Remote alarms for pre-diagnostics with advanced predictive logic



Optimization recommendation by Daikin experts

MULTISITE DASHBOARD

The Daikin *HERO* Cloud Services dashboard offers an overview of the accessible sites and provides the status of the total number of units displaying alarms, errors, warnings, or offline. The dashboard can be customized using the “Customize” button on the top right side of the page to fit the user’s role. The Customize button allows users to add or remove the widgets (Map, Subscription, and Energy management). For example:

» The Subscription widget will display the currently subscribed sites and the expiration date.

» The “Energy Management” widget offers customized bar chart views for the energy consumption of the selected site. This widget will also give users a quick view of their site’s outdoor unit and indoor unit error status and mode of operation.

On the top right of the dashboard, users can switch to dark mode, check the current errors through the notification icon, request site access control through the “key icon,” and edit the user profile.

The screenshot displays the Daikin HERO Cloud Services dashboard interface. At the top, there is a navigation bar with the Daikin logo and HERO Cloud Services branding. Below the navigation bar, the dashboard is divided into several sections:

- Global View: 264 sites:** This section provides a high-level overview of the system's status. It includes a summary of 781 Offline units at 42 sites, 7 Warnings at 5 sites, 45 Cautions at 9 sites, and 144 Errors at 24 sites. A map of the United States shows the locations of these sites. To the right, there is an "Account Info: Licenses" section listing four Daikin DTTP licenses, each with an initial license date of 11/30/2024.
- Site View:** This section provides a detailed view of a specific site, identified as "Daikin DTTP". It is divided into three main categories:
 - Outdoor Units:** Shows 0 of 7 units with alarms. Status indicators for Error (0), Warning (0), Caution (0), and Prediction (0) are displayed. Operation modes include Offline (1), Fan (0), Heat (0), Cool (6), Cool & Heat (0), and Thermo Off (0).
 - Indoor Units:** Shows 13 of 66 units with alarms. Status indicators for Error (0), Warning (0), Cautions (13), and Prediction (0) are displayed. Operation modes include Offline (12), Fan (0), Heat (0), Cool (34), Dry (0), and Thermo Off (20).
 - DAA Rooftop Units:** Shows 0 of 0 units with alarms. Status indicators for Fault (0), Problem (0), Warning (0), and Prediction (0) are displayed. Operation modes include Offline (0), Off (0), Start (0), Recirc (0), Fan Only (0), Econ (0), Cool (0), Heat (0), and Min DAT (0).
- Energy Management:** This section features a bar chart titled "Daikin DTTP" showing energy consumption in kWh over a 24-hour period. The chart is filtered for the day of 09/18/2024. The legend indicates that the bars represent different operation modes: Fan (green), Cool (blue), Cool & Heat (orange), and Heat (red). The energy consumption peaks at approximately 24 kWh around 18:00 CDT.

EQUIPMENT LIST/DETAIL

» The “Equipment List” tab lists all equipment for each site, including the VRV Indoor Unit (IDU) and Outdoor Unit (ODU), Daikin Applied Rooftop Units (RTU), Daikin Comfort Technologies RTU with DDC and connected ancillary equipment via *WAGO* and *BACnet*. The filter or the search bar allows users to search for specific units.

» The “Equipment Detail” page can be viewed by selecting the desired equipment row.

Equipment Details

The piping diagram provides dynamic graphics with real-time data for sensor values with the option to view the sensor description. System operation data is updated

Equipment List

Dashboard Sites **Equipment** Energy Usage Alarms Schedules Customer Service

All Sites All Areas All Edges All Units All Equipment States All Thermostate Reset Search table

Site	Edge Name	Unit Type	Equipment Name	Area	Alinet Address	Model Name	Capacity	Equipment State	Thermostate	ODU FW	Status
000000000	CDU1	IDU	N/A	N/A	N/A	FXMQ16AVJU	8 tons	Cool	Thermo Off	--	
000000000	CDU1	ODU	ODU	N/A	N/A	REYQ16XATJA	14 tons	Fan	Thermo Off	--	
000000110	CDU-2	IDU	IDU	N/A	2	EKEQFCBAV3-US (W)	N/A	Cool	Thermo On	--	
000000110	CDU-2	ODU	ODU	N/A	2	RXYQ240AATJA	20 tons	Cool	Thermo On	--	
000000110	CDU-3	ODU	ODU	N/A	3	RXYQ240AATJA	20 tons	Cool	Thermo Off	--	
000000110	CDU-3	IDU	IDU	N/A	3	EKEQFCBAV3-US (W)	N/A	Cool	Thermo Off	--	
000000110	CDU-1	ODU	ODU	N/A	1	RXYQ240AATJA	20 tons	Cool	Thermo On	--	
000000110	CDU-1	IDU	IDU	N/A	65	EKEQFCBAV3-US (W)	N/A	Cool	Thermo On	--	
011010000	CU-R-1	IDU	IDU	N/A	13	FXMQ18PBVJU	1.5 tons	Cool	Thermo Off	--	
011010000	CU-R-1	IDU	IDU	N/A	18	FXMQ12PBVJU	1 tons	Cool	Thermo On	--	

Showing results 1 - 10 of 6307 Results per page 10

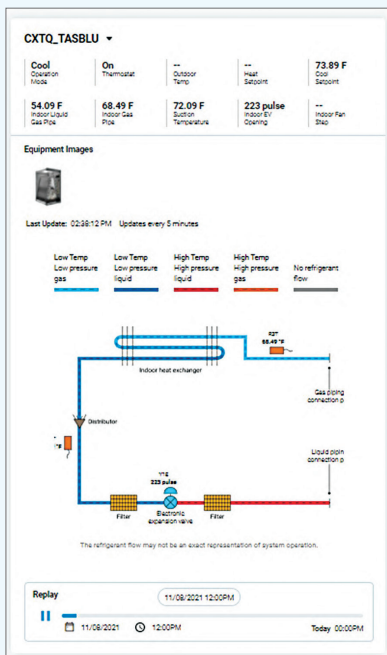

IDU Piping Diagram

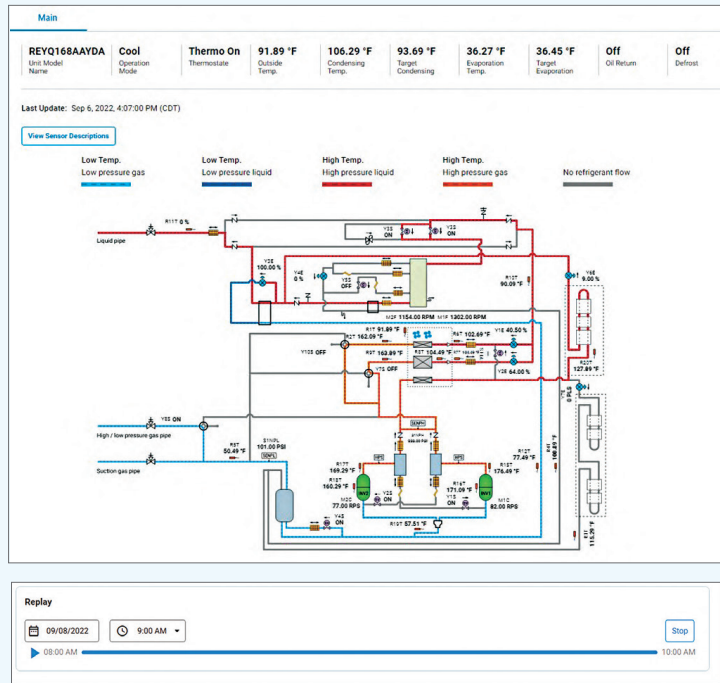

ODU Piping Diagram

EQUIPMENT LIST/DETAIL (CONT.)

in 1 min increments based upon a change of value. In addition, system data can be “Replayed” in 2 hour increments from the stored data (5 years) on the piping diagram.

The “Outdoor Unit” information side widget provides the outdoor unit model name, serial number, Airnet Address,

and linked indoor units and allows remote configuring of the outdoor unit field settings. It also includes links to the manuals for the displayed equipment.

» The “Indoor Unit” information side widget provides the indoor model name, serial number, Airnet Address, group address, and linked outdoor/indoor units.

Outdoor Unit: ODU

Alarms
No active alarms are detected.

Site Information
DTTP Real VRV
19001 Kermer Road
Waller, Texas, 77484
United States
Building Type: Industrial
Unit Location: pure

Outdoor Unit ODU
Equipment Name: ODU
Serial Number: DTTP001
Airnet Address 2
Model Name: REYQ16SAAYDA
Capacity: 14
Outdoor Unit Module: Single
Device Type: Simple Edge
Edge Device Signal: Strong
Edge Name: CU2-1 Device
Field Settings

Unit Modules
Main
REYQ16SAAYDA
Cool & Heat: Thermo Off
Cooling Mode: Thermo Off
39.49 °F: Outdoor Temp
39.51 °F: Outdoor Temp
106.29 °F: Outdoor Temp
39.51 °F: Outdoor Temp
30.69 °F: Outdoor Temp
Off: Outdoor Temp
Off: Outdoor Temp

Unit Modules
Main
REYQ16SAAYDA
Cool & Heat: Thermo Off
Cooling Mode: Thermo Off
39.49 °F: Outdoor Temp
39.51 °F: Outdoor Temp
106.29 °F: Outdoor Temp
39.51 °F: Outdoor Temp
30.69 °F: Outdoor Temp
Off: Outdoor Temp
Off: Outdoor Temp

Unit Modules
Main
REYQ16SAAYDA
Cool & Heat: Thermo Off
Cooling Mode: Thermo Off
39.49 °F: Outdoor Temp
39.51 °F: Outdoor Temp
106.29 °F: Outdoor Temp
39.51 °F: Outdoor Temp
30.69 °F: Outdoor Temp
Off: Outdoor Temp
Off: Outdoor Temp

Outdoor unit information

Indoor Unit: IDU

Alarms
No active alarms are detected.

Site Information
DTTP Real VRV
19001 Kermer Road
Waller, Texas, 77484
United States
Building Type: Industrial
Unit Location: pure

Indoor Unit
Equipment Name: IDU
Serial Number: 0
Group Address: 0
Airnet Address: 1
Model Name: FXEQ_PVJU

Unit Modules
Main
FXEQ_PVJU
Cool: Thermo Off
Cooling Mode: Thermo Off
61.29 °F: Outdoor Temp
32.49 °F: Outdoor Temp
61.29 °F: Outdoor Temp
-62.93 °F: Outdoor Temp
-63.09 °F: Outdoor Temp
77.67 °F: Outdoor Temp
0.00 pulse: Outdoor Temp
0.00: Outdoor Temp

Unit Modules
Main
FXEQ_PVJU
Cool: Thermo Off
Cooling Mode: Thermo Off
61.29 °F: Outdoor Temp
32.49 °F: Outdoor Temp
61.29 °F: Outdoor Temp
-62.93 °F: Outdoor Temp
-63.09 °F: Outdoor Temp
77.67 °F: Outdoor Temp
0.00 pulse: Outdoor Temp
0.00: Outdoor Temp

Indoor unit information

Trend Data

The Trend Data charts section provides four separate graphs (based on the unit of measurement) to make detailed plots of the selected outdoor or indoor unit data. The chart can be plotted for a specific day or week. The data is available for the past five years. Errors are displayed (red arrow) on the trend graph with the time stamp of error occurrence.

The Preset Chart provides preset data points that can be added to the trend graph to visualize the system health. Users also have the ability to create their own custom preset data points that can be labeled and saved to their profile.

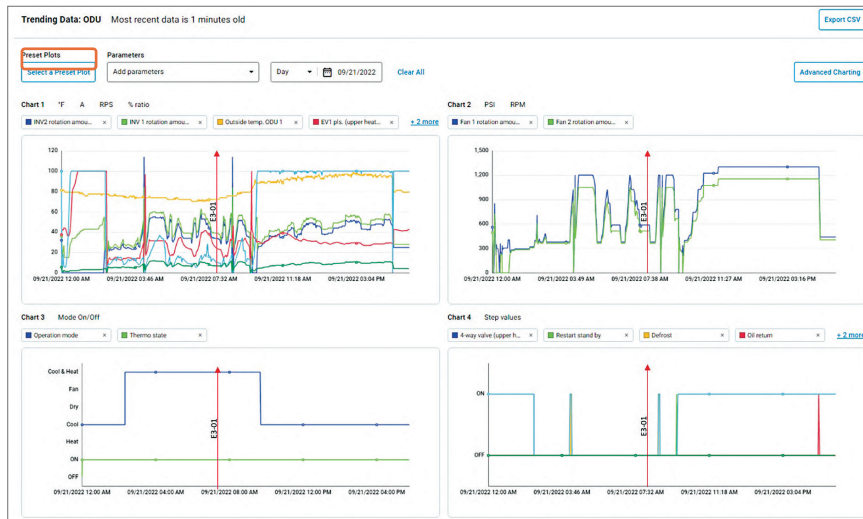

The screenshot shows the 'Preset Charts' interface. It has a 'Create a Custom Preset' section with a list of preset categories on the left and a 'Parameters' list on the right.

- Preset Categories:** Capacity Check, Compressor Health Check, Main Heat Exchanger Component Health, Subcool Heat Exchanger Component Health.
- Parameters:** Target evaporation temp., Operation mode, Oil return, Defrost, INV 1 rotation amount, INV2 rotation amount, Evaporation temp. (TE), Outside temp.

 Below the list is a 'Select an outdoor unit to apply the preset' section with a radio button for 'Main'. 'Cancel' and 'Apply' buttons are at the bottom.

Live Data

The live data from the unit is available for viewing. Users can use the navigation buttons to view additional data or search for particular data. In addition, the data points can be added directly to the trend graphs using the "Add to trending" button. Data can be viewed for a single IDU or for the Main, Sub-1 and Sub-2 for the VRV ODU.

The screenshot shows the 'Live Data: IDU 2' interface. It features a search bar and a table of parameters with their current values and 'Add to trending' buttons.

Parameters	Value
Cool setpoint	61.29 °F
Equipment error level	Normal
Heat setpoint	32.49 °F
Indoor ainet address	2
Indoor EV opening	200.00 pulse
Indoor fan step	5
Indoor gas pipe temp.	-63.09 °F
Indoor liquid pipe temp.	-63.09 °F
Operation mode	Cool
Operation/Stop	On

Indoor unit Live Data

The screenshot shows the 'Live Data: ODU' interface. It features a search bar and a table of parameters for Main, Sub-1, and Sub-2 units. Each parameter has a value and a 'Add to Trending' button.

Parameters	Main	Sub-1	Sub-2
Communication state	Normal	Normal	Normal
Compressor 1 discharge pipe temp.	144.27 °F	141.57 °F	144.43 °F
Compressor 1 discharge stepping down control	Off	Off	Off
Compressor 1 fan stepping down control	Off	Off	Off
Compressor 1 enclosure stepping down control	Off	Off	Off
Compressor 1 surface temp.	145.53 °F	142.83 °F	146.79 °F
Compressor 1 target rotation speed	32.00 rps	33.00 rps	33.00 rps
Compressor suction pipe temp.	69.93 °F	85.41 °F	74.97 °F
Condensing pressure	299.08 PSI	292.00 PSI	292.00 PSI
Condensing temp. (TC)	84.05 °F	84.77 °F	84.77 °F

Outdoor unit Live Data

ENERGY USAGE

The Energy Usage view provides detailed energy monitoring for the connected *VRV* systems. There are 2 selections in the Energy Usage drop down: Energy Management and Runtime. Three types of charts are available on the energy management page:

1. Site Comparison
2. Outdoor Unit Comparison
3. Multisite Consumption

The bar chart allows the user to view energy data for the selected site. The energy consumption data bars are broken down into modes of operation of the outdoor unit, such as Cooling, Heating, Cooling & Heating, and Fan modes.

When the mouse pointer hovers on a bar in the graph, a tooltip displays the actual energy consumption value with more details. The compare feature of the graph provides a way to compare the selected data with past data. Also, the plotted data can be exported using either PNG or CSV file formats.

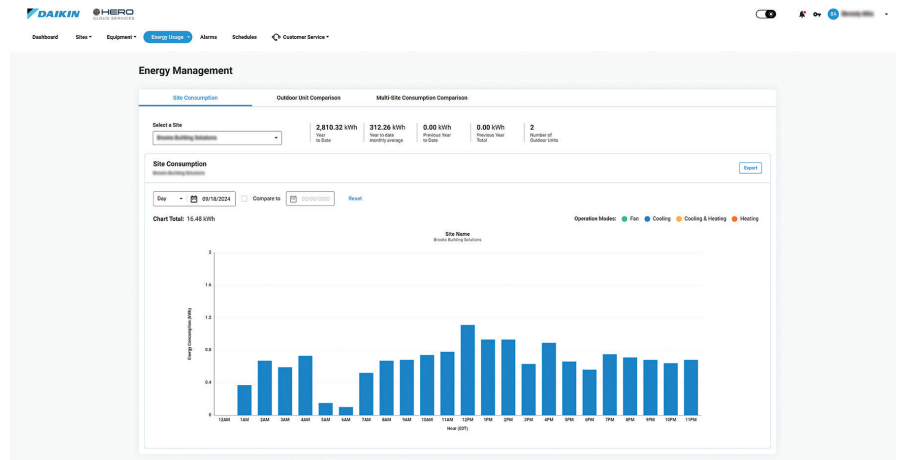

EQUIPMENT CONTROL

Control of the *VRV* indoor unit and ancillary equipment connected via *WAGO* and *BACnet* protocol is available when utilizing the Daikin *HERO* Pro Edge hardware. The user can perform global, zone or individual unit control. When units are selected, an overview of the unit's operation status will be available. The control will be available through Basic, Advanced, R/C prohibition and the Schedules tabs.

Global Control

Perform global controls on all equipment at a site

Unit Control

Perform unit controls on an individual unit at a site

Zone Control

Perform unit controls on a group of units at a site

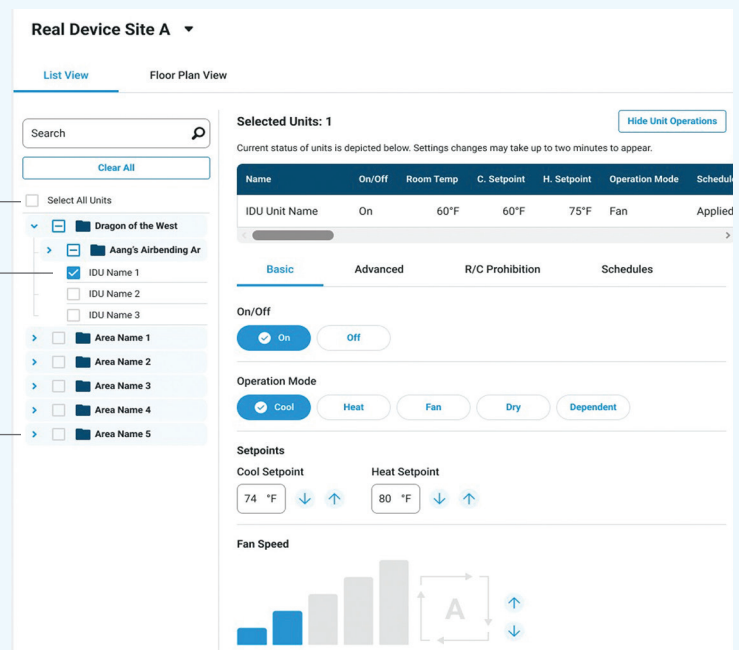

The Alarms Console provides users with a view of current active or inactive alarms (for all connected equipment with an alarm output) with the option to filter among sites, units, and statuses for a specific duration.

The Alarms Console interface includes a navigation bar with 'Alarms' selected. Below the navigation is a filter bar with dropdowns for 'All Sites', 'All Units', 'All Status', and 'All Alarms', along with a date range selector set to '00:00 to 00:00' and a search table button. The main content is a table of alarms:

Sites	Equipment Name	Alarm Type	Alarm Code	Time of Alarm	Status	Occurrences
0110 Douglas	IDU	Caution	A6-20	September 12, 2024 at 08:54:19 AM (CDT)	Inactive	635
0100 High	AA 2 GA 1.00 / GFL S / RC.02A	Caution	A6-20	September 12, 2024 at 12:36:18 PM (EDT)	Active	2774
0110 Douglas	IDU	Caution	A6-20	September 12, 2024 at 08:47:37 AM (CDT)	Inactive	634
0110 Douglas	IDU	Caution	A6-20	September 12, 2024 at 11:34:08 AM (CDT)	Inactive	971
0110 Douglas	IDU	Caution	A6-20	September 12, 2024 at 11:33:11 AM (CDT)	Active	4047

The Error Details page provides information on the error generated along with possible causes and technician tips. It also provides the comments section so a history can be created of actions that were taken on the equipment. Support materials are also available, so the technician never has to leave the Daikin HERO Cloud Services to get more information.

The Error Details page for 'Conf.2761' shows a 'High' priority alarm. The alarm status is 'Active'. The error type is 'Error' with code 'A0-00' and device name 'Edge-C'. The local site time is 'Mar 14, 2022, 7:30:50 AM'. The alarm description is 'T1/T2 Safety Alarm'. Possible causes include 'Safety Device on T1/T2 is open, improper field setting, Defective indoor unit control PCB'. Tech tips advise verifying wire connections to T1 and T2. The condition is 'When an open circuit occurs between external input terminals with the remote controller set to 'external ON/OFF terminal''. The method of detection is 'Detect open or short circuit between external input terminals in indoor unit'. A comments section is available for reporting actions.

» The Schedule feature is available for *VRV* indoor units and equipment connected via *WAGO* and *BACnet* protocol when utilizing the Daikin *HERO* Pro Edge hardware. There are 3 schedule types.

1. **Control Event** – Used to set on/off, mode, setpoints, etc.
2. **IDU Energy Savings Event** – Reduce energy usage of the IDU by adjusting setpoint to meet Critical Peak Pricing events.
3. **Exceptions** – Schedule system operation during special events (holidays, outside normal operating hours events).

Schedules Add Schedule

Real Device Site 1 ▼

View Schedule For: Area Area A ▼

Today
<
>
6/08/2023
Week ▼

■ Controls Event
 ■ IDU Energy Savings Event
 ■ Exception

Sunday 8

Events: ■ 1 ■ 1 ■ 1

Timezone: Central Time

12 AM 1 AM 2 AM 3 AM 4 AM 5 AM 6 AM 7 AM 8 AM 9 AM 10 AM 11 AM 12 PM 1 PM 2 PM 3 PM 4 PM 5 PM 6 PM 7 PM 8 PM 9 PM 10 PM 11 PM 12 AM

Monday 9

Events: ■ 1 ■ 1 ■ 1

Timezone: Central Time

12 AM 1 AM 2 AM 3 AM 4 AM 5 AM 6 AM 7 AM 8 AM 9 AM 10 AM 11 AM 12 PM 1 PM 2 PM 3 PM 4 PM 5 PM 6 PM 7 PM 8 PM 9 PM 10 PM 11 PM 12 AM

Tuesday 10

Events: ■ 1 ■ 1

Timezone: Central Time

12 AM 1 AM 2 AM 3 AM 4 AM 5 AM 6 AM 7 AM 8 AM 9 AM 10 AM 11 AM 12 PM 1 PM 2 PM 3 PM 4 PM 5 PM 6 PM 7 PM 8 PM 9 PM 10 PM 11 PM 12 AM

Wednesday 11

Energy Report

Daikin HERO Cloud Services can provide weekly, monthly and yearly reports which will show the total energy consumption for the connected Daikin VRV equipment.

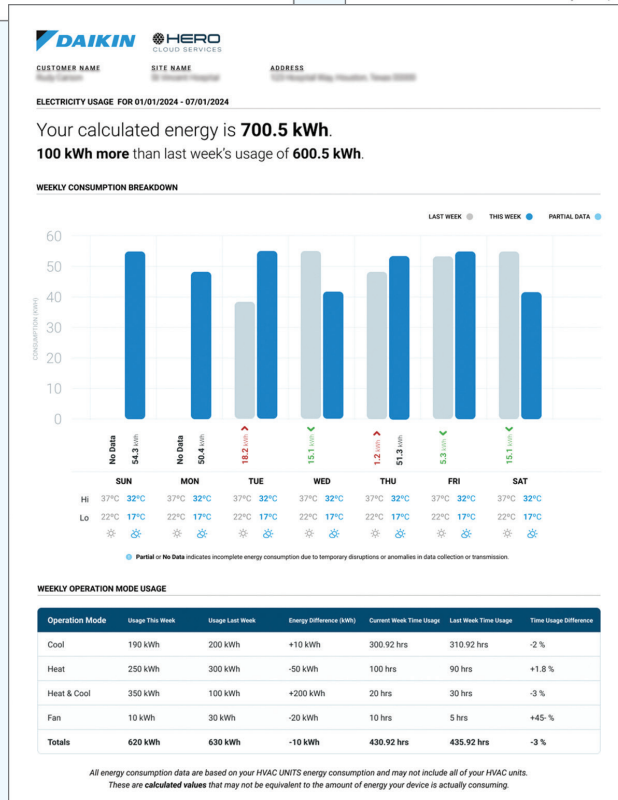
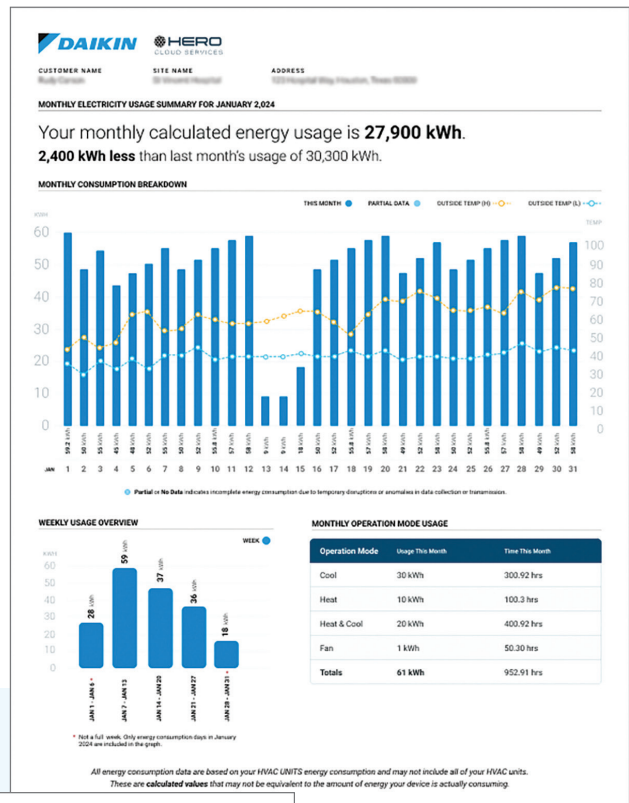
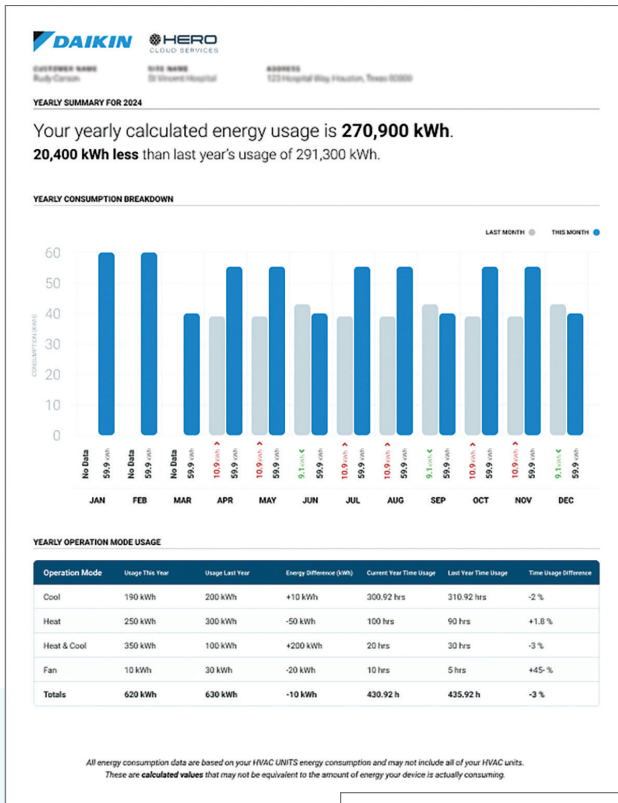

Quarterly Site Report

The quarterly site energy reports can provide a summary of the connected Daikin VRV equipment, the energy consumption of the outdoor units and visualize energy consumption by the operation mode. A quarterly site report is also available for alarms generated on the Daikin HVAC system and connected ancillary equipment.

Quarterly Energy Report

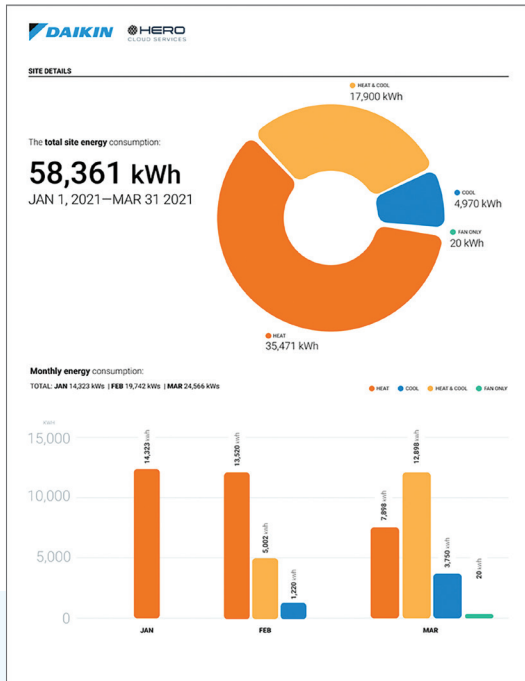

Quarterly Site Summary

Site Summary

SITE ENERGY SUMMARY

Energy Consumption for each month

	JAN	FEB	MAR
Heat	12000	10000	9500
Cool	60	100	350
Heat & Cool	2500	3200	1500
Fan Only	620	152	541
Total	151180	13452	11891

Equipment Cumulative Energy Breakdown

Outdoor Units: Combine consumption for the Quarter January 1st to December 31st

Model Name	Address	Heating (kWh)	Cooling (kWh)	Fan (kWh)	Heating & Cooling (kWh)	Unit Total (kWh)
REVO_TYDN	1	#N/A	89	101	275	5915
REVO_TYDN	2	#N/A	86	103	338	2585
REVO_TYDN	3	#N/A	60	193	558	3807
REVO_TYDN	4	#N/A	88	118	459	3807
REVO_TYDN	5	#N/A	93	97	315	2761
REVO_TYDN	6	#N/A	78	55	627	3784
REVO_TYDN	7	#N/A	93	110	468	5481
REVO_TYDN	8	#N/A	65	166	514	6681
REVO_TYDN	9	#N/A	89	98	279	2716
REVO_TYDN	10	2373	94	59	261	2787
REVO_TYDN	11	6070	75	112	376	6633
SITE TOTAL		44,032	890	1212	4,470	50,604

Quarterly Alarms Report

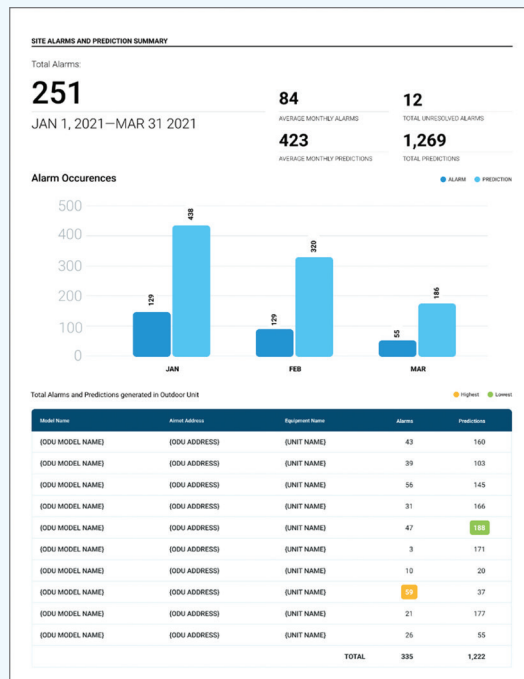

SITES (ADMINISTRATION)

The Sites page (administration) provides sites, users and device management. Multiple user roles are available to fit different user types (Manufacture Rep, Distributor, Contractor, Engineer, Building Owner). A site, a user or a device can be added or edited by an admin user role.

Name	Address	Building Type	License Expiration
Truist Field #12110	2200 Pershing Street, Madison, Wisconsin, 53704, United States	Government	
WBI Mobile Training Lab	Wright Brothers Boulevard SW, Cedar Rapids, Iowa, 52404, United States	Other(Commercial)	09/30/2025
Chief Joseph Fish Hatchery	Half Sun Way, Bridgeport, Washington, 98513, United States	Other(Commercial)	09/30/2025
Thomas Jefferson Hall	500 9th Avenue, Louisville, MO, 63021, United States	Education	09/30/2025
Galton Deer Park	112 Brook Avenue, Deer Park, New York, 11725, United States	Training Center	09/30/2025
CMR2 Police	1685 East 115th Street, Cleveland, Ohio, 44126, United States	Fire/Police Stations	09/30/2025

The User Profile is adjustable according to individual preferences, allowing modifications to various elements such as personal information, business information, temperature units, time format, notification choices, and report selections.

Personal Information

BA [Verify](#)

Super Admin

Business Information

DAIKIN NORTH AMERICA LLC
 19001 Kermier Rd,
 Waller, Texas 77484
 US

Unit Preferences

Temperature Unit

Fahrenheit

Celsius

Notifications

Please choose the type of notifications you want to receive from your site(s).

Cautions

Warnings

	Daikin <i>HERO</i> Simple Edge	Daikin <i>HERO</i> Pro Edge
Model	DSE40A71	DGE601A71
Description	Daikin <i>HERO</i> Simple Edge Cloud Communication Adaptor	Daikin <i>HERO</i> Pro Edge
Maximum Connections	64 Indoor Units / 1 Outdoor Unit	128 IDU / 14 ODU (512 IDU / 56 ODU with the use of Plus adaptors)
Communication to Outdoor unit	Proprietary	Proprietary
Communication to Cloud	LTE-CAT-M (Verizon) Continental United States, Alaska, Hawaii, and Canada.	Ethernet or optional LTE router
Power	16VDC supplied by Outdoor Unit, less than 3W	24VAC 36VA
Operating Temp Range	-22 to 125°F (-30-52°C)	14 to 122°F (-10-50°C)
Storage Temp range	-22 to 158°F (-30-70°C)	-22 to 158°F (-30-70°C)
Operating Humidity Range	Less than 95% RH (Non-condensing)	Less than 85% RH (Non-condensing)
Storage Temp range	Less than 95% RH (Non-condensing)	Less than 85% R H(Non-condensing)
Installation Elevation	Less than 6500 ft. (2000 m)	Inside Controls Enclosure
Dimensions (W x H x D)	6.2" X 3.8" X 1.7" (160 mm X 96 mm X 42 mm)	9.05"X3.2"X5.75" (230mm X 81mm X 146mm)
Weight (Mass)	1.0 lb. (0.46 kg)	3.35 lb (1.52kg)
Communication wire	9-33/64 ft. (2900 mm)	Maximum wiring distance between units 3,280 ft. Total wire length 6,560 ft.
Conversion harness	0.55 ft. (170 mm)	N/A
Enclosure Rating	IP66	N/A
Daikin <i>HERO</i> Cloud Services		
Compatible Browser	Google Chrome™, Safari®	
Compatible Devices	PC, MAC®, Smartphone, and Tablet with internet connection	
Requires Subscription	Yes	
URL	www.daikinhero.com	

FOR QUESTIONS OR SUPPORT:

1-833-HERO-100 • daikinhero.support@daikincomfort.com

About Daikin:

Daikin Industries, Ltd. (DIL) is a global Fortune 1000 company and is recognized as one of the largest HVAC (Heating, Ventilation, Air Conditioning) manufacturers in the world. Founded in 1924, Daikin is celebrating 100 years of HVAC worldwide leadership. DIL is primarily engaged in developing indoor comfort systems and refrigeration products for residential, commercial, and industrial applications. Its consistent success is derived, in part, from a focus on innovative, energy-efficient, and premium quality indoor climate and comfort management solutions.

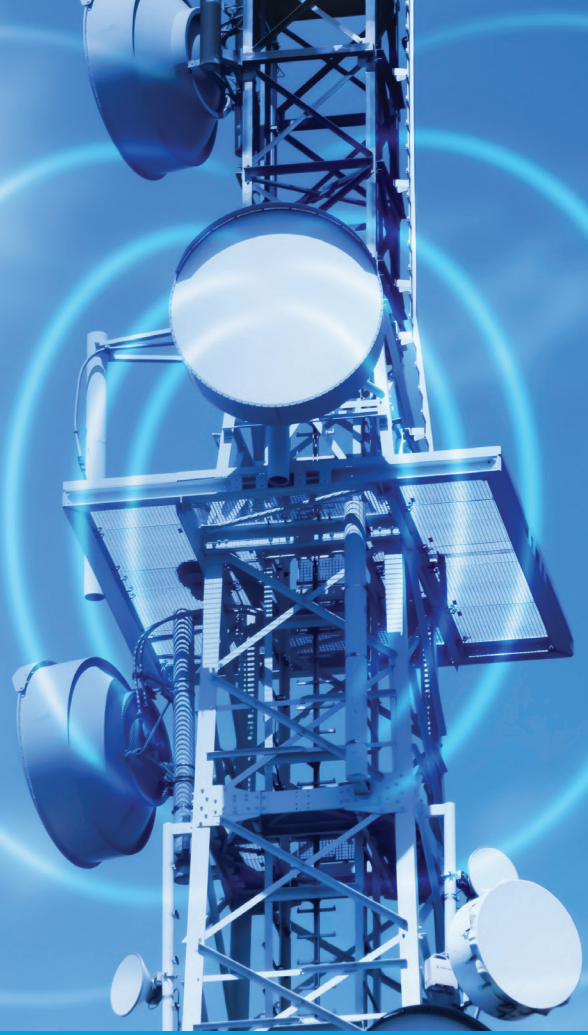

Learn more at www.daikincomfort.com



For more information scan QR code to go to the *Daikin* HERO Cloud Services landing page.

BACnet™ is a trademark of ASHRAE.

Google Chrome is a trademark of Google LLC.
Safari and *Mac* are registered trademarks of Apple Inc.

ADDITIONAL INFORMATION

Before purchasing this appliance, read important information about its estimated annual energy consumption, yearly operating cost, or energy efficiency rating that is available from your retailer.



Our continuing commitment to quality products may mean a change in specifications without notice.
© 2025 DAIKIN COMFORT TECHNOLOGIES NORTH AMERICA, INC.
Houston, Texas · USA · www.northamerica-daikin.com

CB-HEROCS_03-25