



EDUS282233A-D

R-410A

Engineering Data

SkyAir

Cooling Only 60 Hz
Heat Pump 60 Hz

Design Manual

RZR-TBVJUA / RZQ-TBVJUA



INVERTER

Table of Contents

1. External Appearance	3
1.1 Indoor Unit	3
1.2 Outdoor Unit.....	4
2. Model Name and Power Supply	5
2.1 Cooling Only	5
2.2 Heat Pump	6
3. Nomenclature	7
4. Specifications	9
4.1 Cooling Only	9
4.2 Heat Pump	19
5. Dimensions.....	29
5.1 Indoor Unit	29
5.2 Wired Remote Controller (Accessory)	38
5.3 Wireless Remote Controller (Accessory)	41
5.4 Outdoor Unit.....	43
6. Installation Service Space	45
7. Center of Gravity	49
7.1 Indoor Unit	49
7.2 Outdoor Unit.....	51
8. Piping Diagrams	53
8.1 Indoor Unit	53
8.2 Outdoor Unit.....	57
9. Wiring Diagrams.....	59
9.1 Indoor Unit	59
9.2 Outdoor Unit.....	63
10. Field Wiring	65
11. Electrical Characteristics	67
11.1 Indoor Unit	67
11.2 Electric Heater	71
11.3 Outdoor Unit.....	73
12. Operation Limits	74
13. Sound Levels (Reference Data)	75
13.1 Indoor Unit	75
13.2 Outdoor Unit (Cooling Only).....	105
13.3 Outdoor Unit (Heat Pump)	107
14. Accessories	111
14.1 Indoor Unit	111
14.2 Outdoor Unit.....	115

15. Caution Label	116
15.1 RZR18 - 24TBVJUA, RZQ18 - 24TBVJUA	116
15.2 RZR30 - 48TBVJUA, RZQ30 - 48TBVJUA	120
16. Caution for Refrigerant Leaks	124
16.1 Introduction	124
16.2 Procedure for Checking Maximum Concentration	125
17. Safety Devices List.....	126
17.1 FCQ	126
17.2 FAQ.....	126
17.3 FBQ.....	126
17.4 FTQ.....	127
18. Fan Performances.....	128
18.1 FBQ.....	128
19. Airflow Auto Adjustment Characteristics.....	133
19.1 FBQ.....	133
19.2 FTQ.....	138

1. External Appearance

1.1 Indoor Unit

Ceiling mounted cassette type (round flow with sensing)

FCQ18AAVJU
 FCQ24AAVJU
 FCQ30AAVJU
 FCQ36AAVJU
 FCQ42AAVJU
 FCQ48AAVJU



Wall mounted type

FAQ18TAVJU
 FAQ24TAVJU



HSP concealed ducted unit

FBQ18TBVJU
 FBQ24TBVJU
 FBQ30TBVJU
 FBQ36TBVJU
 FBQ42TBVJU
 FBQ48TBVJU



Air handling unit

FTQ18TAVJUD FTQ18TAVJUA
 FTQ24TAVJUD FTQ24TAVJUA
 FTQ30TAVJUD FTQ30TAVJUA
 FTQ36TAVJUD FTQ36TAVJUA
 FTQ42TAVJUD FTQ42TAVJUA
 FTQ48TAVJUD FTQ48TAVJUA

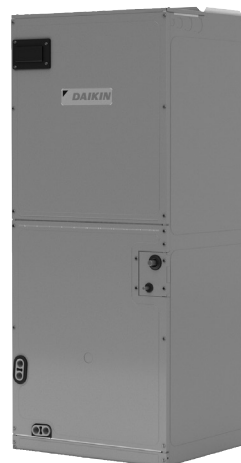

1.2 Outdoor Unit

RZR18TBVJUA
RZR24TBVJUA

RZQ18TBVJUA
RZQ24TBVJUA



RZR30TBVJUA
RZR36TBVJUA
RZR42TBVJUA
RZR48TBVJUA

RZQ30TBVJUA
RZQ36TBVJUA
RZQ42TBVJUA
RZQ48TBVJUA



2. Model Name and Power Supply

2.1 Cooling Only

Indoor unit		Outdoor unit	Power supply intake	
Type	Model name	Model name	Indoor unit (Separate-power-supply required)	Outdoor unit
Ceiling mounted cassette type (round flow with sensing)	FCQ18AAVJU	RZR18TBVJUA	1 phase, 208/230 V, 60 Hz	1 phase, 208/230 V, 60 Hz
	FCQ24AAVJU	RZR24TBVJUA		
	FCQ30AAVJU	RZR30TBVJUA		
	FCQ36AAVJU	RZR36TBVJUA		
	FCQ42AAVJU	RZR42TBVJUA		
	FCQ48AAVJU	RZR48TBVJUA		
Wall mounted type	FAQ18TAVJU	RZR18TBVJUA	1 phase, 208/230 V, 60 Hz	1 phase, 208/230 V, 60 Hz
	FAQ24TAVJU	RZR24TBVJUA		
HSP concealed ducted unit	FBQ18TBVJU	RZR18TBVJUA	1 phase, 208/230 V, 60 Hz	1 phase, 208/230 V, 60 Hz
	FBQ24TBVJU	RZR24TBVJUA		
	FBQ30TBVJU	RZR30TBVJUA		
	FBQ36TBVJU	RZR36TBVJUA		
	FBQ42TBVJU	RZR42TBVJUA		
	FBQ48TBVJU	RZR48TBVJUA		
Air handling unit	FTQ18TAVJUD FTQ18TAVJUA	RZR18TBVJUA	1 phase, 208/230 V, 60 Hz	1 phase, 208/230 V, 60 Hz
	FTQ24TAVJUD FTQ24TAVJUA	RZR24TBVJUA		
	FTQ30TAVJUD FTQ30TAVJUA	RZR30TBVJUA		
	FTQ36TAVJUD FTQ36TAVJUA	RZR36TBVJUA		
	FTQ42TAVJUD FTQ42TAVJUA	RZR42TBVJUA		
	FTQ48TAVJUD FTQ48TAVJUA	RZR48TBVJUA		

2.2 Heat Pump

Indoor unit		Outdoor unit	Power supply intake	
Type	Model name	Model name	Indoor unit (Separate-power-supply required)	Outdoor unit
Ceiling mounted cassette type (round flow with sensing)	FCQ18AAVJU	RZQ18TBVJUA	1 phase, 208/230 V, 60 Hz	1 phase, 208/230 V, 60 Hz
	FCQ24AAVJU	RZQ24TBVJUA		
	FCQ30AAVJU	RZQ30TBVJUA		
	FCQ36AAVJU	RZQ36TBVJUA		
	FCQ42AAVJU	RZQ42TBVJUA		
	FCQ48AAVJU	RZQ48TBVJUA		
Wall mounted type	FAQ18TAVJU	RZQ18TBVJUA	1 phase, 208/230 V, 60 Hz	1 phase, 208/230 V, 60 Hz
	FAQ24TAVJU	RZQ24TBVJUA		
HSP concealed ducted unit	FBQ18TBVJU	RZQ18TBVJUA	1 phase, 208/230 V, 60 Hz	1 phase, 208/230 V, 60 Hz
	FBQ24TBVJU	RZQ24TBVJUA		
	FBQ30TBVJU	RZQ30TBVJUA		
	FBQ36TBVJU	RZQ36TBVJUA		
	FBQ42TBVJU	RZQ42TBVJUA		
	FBQ48TBVJU	RZQ48TBVJUA		
Air handling unit	FTQ18TAVJUD FTQ18TAVJUA	RZQ18TBVJUA	1 phase, 208/230 V, 60 Hz	1 phase, 208/230 V, 60 Hz
	FTQ24TAVJUD FTQ24TAVJUA	RZQ24TBVJUA		
	FTQ30TAVJUD FTQ30TAVJUA	RZQ30TBVJUA		
	FTQ36TAVJUD FTQ36TAVJUA	RZQ36TBVJUA		
	FTQ42TAVJUD FTQ42TAVJUA	RZQ42TBVJUA		
	FTQ48TAVJUD FTQ48TAVJUA	RZQ48TBVJUA		

3. Nomenclature

Indoor unit

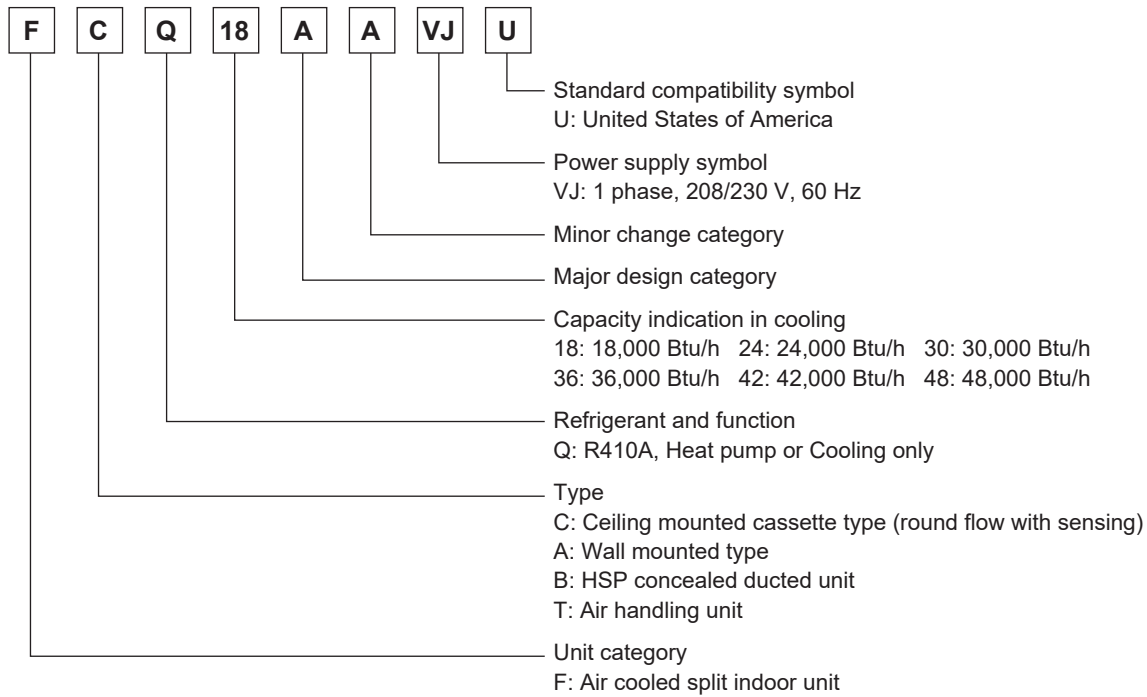

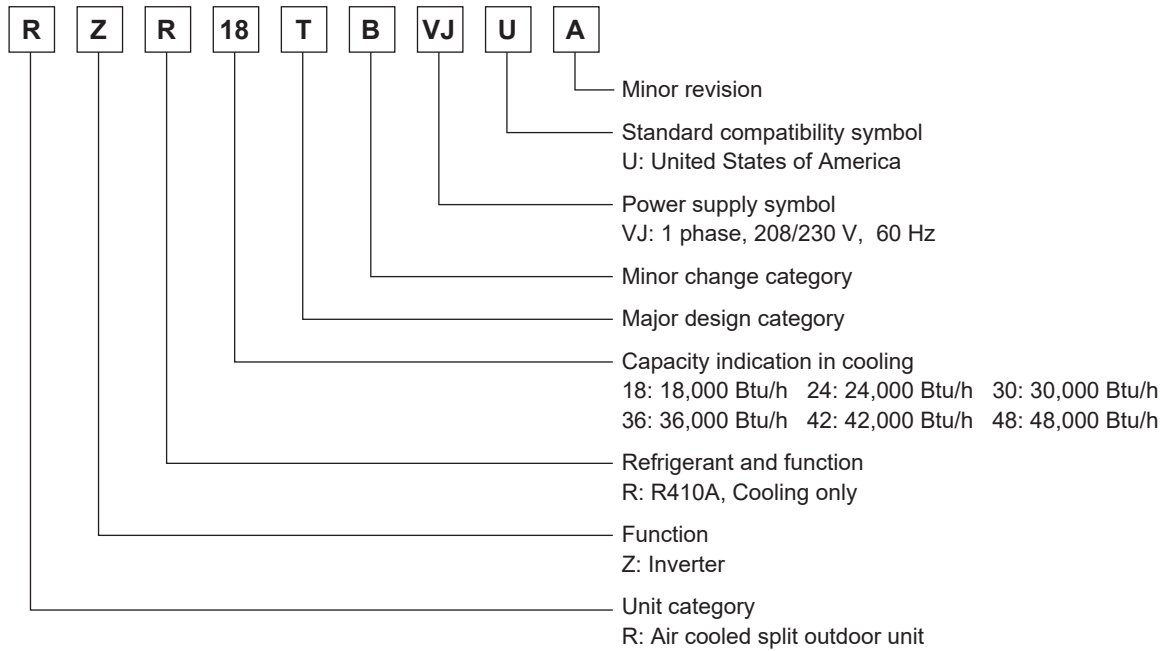
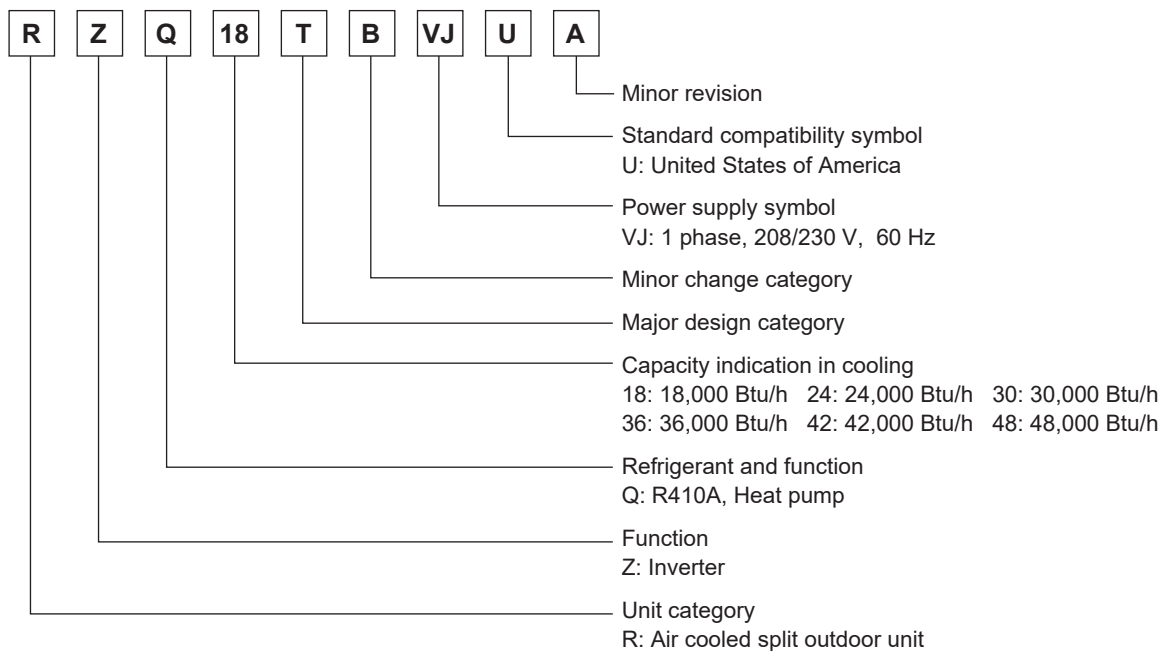
Outdoor unit (cooling only)**Outdoor unit (heat pump)**

4. Specifications

4.1 Cooling Only

4.1.1 FCQ

Ceiling mounted cassette type (round flow with sensing)

Model	Indoor unit		FCQ18AAVJU		FCQ24AAVJU		
	Outdoor unit		RZR18TBVJUA		RZR24TBVJUA		
Power supply			1 phase, 208/230 V, 60 Hz		1 phase, 208/230 V, 60 Hz		
Cooling capacity ★1, ★2		Btu/h (kW)	18,000 (5.3)		24,000 (7.0)		
EER2 (rated)		Btu/h-W	13.0		12.0		
SEER2 (rated)			18.5		18.6		
Indoor unit			FCQ18AAVJU		FCQ24AAVJU		
Casing/color			Galvanized steel plate		Galvanized steel plate		
Dimensions	H × W × D	in. (mm)	9-11/16 × 33-1/16 × 33-1/16 (246 × 840 × 840)		9-11/16 × 33-1/16 × 33-1/16 (246 × 840 × 840)		
Coil	Type		Cross fin coil		Cross fin coil		
	Type		Turbo fan		Turbo fan		
Fan	Motor output	W	53		53		
	Airflow rate (H / M / L)	cfm (m ³ /min)	742 / 618 / 477 (21.0 / 17.5 / 13.5)		777 / 618 / 477 (22.0 / 17.5 / 13.5)		
	External static pressure	in.H ₂ O (Pa)	—		—		
Air filter			—		—		
Weight		lbs (kg)	51 (23)		51 (23)		
Piping connections	Liquid	in. (mm)	φ3/8 (φ9.5) (flare connection)		φ3/8 (φ9.5) (flare connection)		
	Gas	in. (mm)	φ5/8 (φ15.9) (flare connection)		φ5/8 (φ15.9) (flare connection)		
	Drain	in. (mm)	VP25 (external dia. 1-1/4 (32), internal dia. 1 (26))		VP25 (external dia. 1-1/4 (32), internal dia. 1 (26))		
Remote controller (accessory)	Wired		BRC1E73 / BRC1H71W / DTST-ONE-ADA-A		BRC1E73 / BRC1H71W / DTST-ONE-ADA-A		
	Wireless		—		—		
Decoration panel (accessory)	Model		BYCQ54EEFU / BYCQ54EEGFU		BYCQ54EEFU / BYCQ54EEGFU		
	Color		Fresh white		Fresh white		
	Dimensions	H × W × D	in. (mm)	2 × 37-3/8 × 37-3/8 / 5-1/8 × 37-3/8 × 37-3/8 (50 × 950 × 950 / 130 × 950 × 950)		2 × 37-3/8 × 37-3/8 / 5-1/8 × 37-3/8 × 37-3/8 (50 × 950 × 950 / 130 × 950 × 950)	
	Air filter		Resin net (with mold resistance)		Resin net (with mold resistance)		
	Weight		lbs (kg)	12 (5.5) / 22 (10.0)		12 (5.5) / 22 (10.0)	
Outdoor unit			RZR18TBVJUA		RZR24TBVJUA		
Casing/color			Ivory white		Ivory white		
Dimensions	H × W × D	in. (mm)	39 × 37 × 12-5/8 (990 × 940 × 320)		39 × 37 × 12-5/8 (990 × 940 × 320)		
Coil	Type		Cross fin coil		Cross fin coil		
Compressor	Type		Hermetically sealed swing type		Hermetically sealed swing type		
	Motor output	kW	1.9		1.9		
Fan	Type		Propeller fan		Propeller fan		
	Motor output	W	200		200		
	Airflow rate	cfm (m ³ /min)	2,682 (76)		2,682 (76)		
Weight		lbs (kg)	172 (78)		172 (78)		
Piping connections	Liquid	in. (mm)	φ3/8 (φ9.5) (flare connection)		φ3/8 (φ9.5) (flare connection)		
	Gas	in. (mm)	φ5/8 (φ15.9) (flare connection)		φ5/8 (φ15.9) (flare connection)		
	Drain	in. (mm)	φ1 (φ26) (hole)		φ1 (φ26) (hole)		
Safety devices			High pressure switch, Outdoor fan driver overload protector, Inverter overload protector, Fusible plug, Fuse		High pressure switch, Outdoor fan driver overload protector, Inverter overload protector, Fusible plug, Fuse		
Capacity step		%	14-100		14-100		
Refrigerant control			Electronic expansion valve		Electronic expansion valve		
Ref. piping	Standard length	ft (m)	25 (7.6)		25 (7.6)		
	Max. length	ft (m)	164 (50)		164 (50)		
	Max. height difference	ft (m)	98 (30)		98 (30)		
Refrigerant	Type		R410A		R410A		
	Charge	lbs (kg)	6.4 (2.9)		6.4 (2.9)		
Ref. oil	Type		DAPHNE FVC50K		DAPHNE FVC50K		
	Charge	L	1.08		1.08		

Note:

★1. Indoor temp.: 80°FDB (26.7°CDB), 67°FWB (19.4°CWB) / Outdoor temp.: 95°FDB (35.0°CDB) / Equivalent piping length: 25 ft. (7.6 m), height difference: 0 ft. (0 m).

★2. Capacities are net, including a deduction for cooling for indoor fan motor heat.

C: 4D143003B

Ceiling mounted cassette type (round flow with sensing), continued

Model	Indoor unit		FCQ30AAVJU	FCQ36AAVJU
	Outdoor unit		RZR30TBVJUA	RZR36TBVJUA
Power supply			1 phase, 208/230 V, 60 Hz	1 phase, 208/230 V, 60 Hz
Cooling capacity ★1, ★2	Btu/h (kW)		30,000 (8.8)	36,000 (10.6)
EER2 (rated)	Btu/h-W		13.0	12.1
SEER2 (rated)			21.0	20.0
Indoor unit			FCQ30AAVJU	FCQ36AAVJU
Casing/color			Galvanized steel plate	Galvanized steel plate
Dimensions	H × W × D	in. (mm)	11-11/32 × 33-1/16 × 33-1/16 (288 × 840 × 840)	11-11/32 × 33-1/16 × 33-1/16 (288 × 840 × 840)
Coil	Type		Cross fin coil	Cross fin coil
Fan	Type		Turbo fan	Turbo fan
	Motor output	W	106	106
	Airflow rate (H / M / L)	cfm (m ³ /min)	1,059 / 882 / 671 (30.0 / 25.0 / 19.0)	1,253 / 918 / 671 (35.5 / 26.0 / 19.0)
	External static pressure	in.H ₂ O (Pa)	—	—
Air filter			—	—
Weight	lbs (kg)		58 (26)	58 (26)
Piping connections	Liquid	in. (mm)	φ3/8 (φ9.5) (flare connection)	φ3/8 (φ9.5) (flare connection)
	Gas	in. (mm)	φ5/8 (φ15.9) (flare connection)	φ5/8 (φ15.9) (flare connection)
	Drain	in. (mm)	VP25 (external dia. 1-1/4 (32), internal dia. 1 (26))	VP25 (external dia. 1-1/4 (32), internal dia. 1 (26))
Remote controller (accessory)	Wired		BRC1E73 / BRC1H71W / DTST-ONE-ADA-A	BRC1E73 / BRC1H71W / DTST-ONE-ADA-A
	Wireless		—	—
Decoration panel (accessory)	Model		BYCQ54EEFU / BYCQ54EEGFU	BYCQ54EEFU / BYCQ54EEGFU
	Color		Fresh white	Fresh white
	Dimensions	H × W × D in. (mm)	2 × 37-3/8 × 37-3/8 / 5-1/8 × 37-3/8 × 37-3/8 (50 × 950 × 950 / 130 × 950 × 950)	2 × 37-3/8 × 37-3/8 / 5-1/8 × 37-3/8 × 37-3/8 (50 × 950 × 950 / 130 × 950 × 950)
	Air filter		Resin net (with mold resistance)	Resin net (with mold resistance)
	Weight	lbs (kg)	12 (5.5) / 22 (10.0)	12 (5.5) / 22 (10.0)
Outdoor unit			RZR30TBVJUA	RZR36TBVJUA
Casing/color			Ivory white	Ivory white
Dimensions	H × W × D	in. (mm)	52-15/16 × 35-7/16 × 12-5/8 (1,345 × 900 × 320)	52-15/16 × 35-7/16 × 12-5/8 (1,345 × 900 × 320)
Coil	Type		Cross fin coil	Cross fin coil
Compressor	Type		Hermetically sealed swing type	Hermetically sealed swing type
	Motor output	kW	3.5	3.5
Fan	Type		Propeller fan	Propeller fan
	Motor output	W	70 × 2	70 × 2
	Airflow rate	cfm (m ³ /min)	3,741 (106)	3,741 (106)
Weight	lbs (kg)		225 (102)	225 (102)
Piping connections	Liquid	in. (mm)	φ3/8 (φ9.5) (flare connection)	φ3/8 (φ9.5) (flare connection)
	Gas	in. (mm)	φ5/8 (φ15.9) (flare connection)	φ5/8 (φ15.9) (flare connection)
	Drain	in. (mm)	φ1 (φ26) (hole)	φ1 (φ26) (hole)
Safety devices			High pressure switch, Outdoor fan driver overload protector, Inverter overload protector, Fusible plug, Fuse	High pressure switch, Outdoor fan driver overload protector, Inverter overload protector, Fusible plug, Fuse
Capacity step	%		14-100	14-100
Refrigerant control			Electronic expansion valve	Electronic expansion valve
Ref. piping	Standard length	ft (m)	25 (7.6)	25 (7.6)
	Max. length	ft (m)	230 (70)	230 (70)
	Max. height difference	ft (m)	98 (30)	98 (30)
Refrigerant	Type		R410A	R410A
	Charge	lbs (kg)	7.9 (3.6)	7.9 (3.6)
Ref. oil	Type		DAPHNE FVC50K	DAPHNE FVC50K
	Charge	L	1.52	1.52

Note:

★1. Indoor temp.: 80°FDB (26.7°CDB), 67°FWB (19.4°CWB) / Outdoor temp.: 95°FDB (35.0°CDB) / Equivalent piping length: 25 ft. (7.6 m), height difference: 0 ft. (0 m).

★2. Capacities are net, including a deduction for cooling for indoor fan motor heat.

C: 4D143004B

Ceiling mounted cassette type (round flow with sensing), continued

Model	Indoor unit		FCQ42AAVJU	FCQ48AAVJU
	Outdoor unit		RZR42TBVJUA	RZR48TBVJUA
Power supply			1 phase, 208/230 V, 60 Hz	1 phase, 208/230 V, 60 Hz
Cooling capacity ★1, ★2		Btu/h (kW)	42,000 (12.3)	48,000 (14.1)
EER2 (rated)		Btu/h-W	10.3	8.2
SEER2 (rated)			18.9	18.0
Indoor unit			FCQ42AAVJU	FCQ48AAVJU
Casing/color			Galvanized steel plate	Galvanized steel plate
Dimensions	H × W × D	in. (mm)	11-11/32 × 33-1/16 × 33-1/16 (288 × 840 × 840)	11-11/32 × 33-1/16 × 33-1/16 (288 × 840 × 840)
Coil	Type		Cross fin coil	Cross fin coil
Fan	Type		Turbo fan	Turbo fan
	Motor output	W	106	106
	Airflow rate (H / M / L)	cfm (m ³ /min)	1,253 / 971 / 741 (35.5 / 27.5 / 21.0)	1,253 / 971 / 741 (35.5 / 27.5 / 21.0)
	External static pressure	in.H ₂ O (Pa)	—	—
Air filter			—	—
Weight		lbs (kg)	58 (26)	58 (26)
Piping connections	Liquid	in. (mm)	φ3/8 (φ9.5) (flare connection)	φ3/8 (φ9.5) (flare connection)
	Gas	in. (mm)	φ5/8 (φ15.9) (flare connection)	φ5/8 (φ15.9) (flare connection)
	Drain	in. (mm)	VP25 (external dia. 1-1/4 (32), internal dia. 1 (26))	VP25 (external dia. 1-1/4 (32), internal dia. 1 (26))
Remote controller (accessory)	Wired		BRC1E73 / BRC1H71W / DTST-ONE-ADA-A	BRC1E73 / BRC1H71W / DTST-ONE-ADA-A
	Wireless		—	—
Decoration panel (accessory)	Model		BYCQ54EEFU / BYCQ54EEGFU	BYCQ54EEFU / BYCQ54EEGFU
	Color		Fresh white	Fresh white
	Dimensions	H × W × D in. (mm)	2 × 37-3/8 × 37-3/8 / 5-1/8 × 37-3/8 × 37-3/8 (50 × 950 × 950 / 130 × 950 × 950)	2 × 37-3/8 × 37-3/8 / 5-1/8 × 37-3/8 × 37-3/8 (50 × 950 × 950 / 130 × 950 × 950)
	Air filter		Resin net (with mold resistance)	Resin net (with mold resistance)
	Weight		lbs (kg)	12 (5.5) / 22 (10.0)
Outdoor unit			RZR42TBVJUA	RZR48TBVJUA
Casing/color			Ivory white	Ivory white
Dimensions	H × W × D	in. (mm)	52-15/16 × 35-7/16 × 12-5/8 (1,345 × 900 × 320)	52-15/16 × 35-7/16 × 12-5/8 (1,345 × 900 × 320)
Coil	Type		Cross fin coil	Cross fin coil
Compressor	Type		Hermetically sealed swing type	Hermetically sealed swing type
	Motor output	kW	3.5	3.5
Fan	Type		Propeller fan	Propeller fan
	Motor output	W	70 × 2	70 × 2
	Airflow rate	cfm (m ³ /min)	3,741 (106)	3,741 (106)
Weight		lbs (kg)	225 (102)	225 (102)
Piping connections	Liquid	in. (mm)	φ3/8 (φ9.5) (flare connection)	φ3/8 (φ9.5) (flare connection)
	Gas	in. (mm)	φ5/8 (φ15.9) (flare connection)	φ5/8 (φ15.9) (flare connection)
	Drain	in. (mm)	φ1 (φ26) (hole)	φ1 (φ26) (hole)
Safety devices			High pressure switch, Outdoor fan driver overload protector, Inverter overload protector, Fusible plug, Fuse	High pressure switch, Outdoor fan driver overload protector, Inverter overload protector, Fusible plug, Fuse
Capacity step		%	14-100	14-100
Refrigerant control			Electronic expansion valve	Electronic expansion valve
Ref. piping	Standard length	ft (m)	25 (7.6)	25 (7.6)
	Max. length	ft (m)	230 (70)	230 (70)
	Max. height difference	ft (m)	98 (30)	98 (30)
Refrigerant	Type		R410A	R410A
	Charge	lbs (kg)	7.9 (3.6)	7.9 (3.6)
Ref. oil	Type		DAPHNE FVC50K	DAPHNE FVC50K
	Charge	L	1.52	1.52

Note:

★1. Indoor temp.: 80°FDB (26.7°CDB), 67°FWB (19.4°CWB) / Outdoor temp.: 95°FDB (35.0°CDB) / Equivalent piping length: 25 ft. (7.6 m), height difference: 0 ft. (0 m).

★2. Capacities are net, including a deduction for cooling for indoor fan motor heat.

C: 4D143004B

4.1.2 FAQ

Wall mounted type

Model	Indoor unit		FAQ18TAVJU		FAQ24TAVJU	
	Outdoor unit		RZR18TBVJUA		RZR24TBVJUA	
Power supply			1 phase, 208/230 V, 60 Hz		1 phase, 208/230 V, 60 Hz	
Cooling capacity ★1, ★2	Btu/h (kW)		18,000 (5.3)		24,000 (7.0)	
EER2 (rated)	Btu/h-W		11.9		10.2	
SEER2 (rated)			16.9		17.3	
Indoor unit			FAQ18TAVJU		FAQ24TAVJU	
Casing/color			White (3.0Y8.5/0.5)		White (3.0Y8.5/0.5)	
Dimensions	H × W × D	in. (mm)	11-3/8 × 41-3/8 × 9-1/4 (290 × 1,050 × 238)		11-3/8 × 41-3/8 × 9-1/4 (290 × 1,050 × 238)	
Coil	Type		Cross fin coil		Cross fin coil	
Fan	Type		Cross flow fan		Cross flow fan	
	Motor output	W	43		43	
	Airflow rate (H / L)	cfm (m ³ /min)	500 / 400 (14 / 11)		635 / 470 (18 / 13)	
	External static pressure	in.H ₂ O (Pa)	—		—	
Air filter			Resin net (washable)		Resin net (washable)	
Weight	lbs (kg)		31 (14)		31 (14)	
Piping connections	Liquid	in. (mm)	φ3/8 (φ9.5) (flare connection)		φ3/8 (φ9.5) (flare connection)	
	Gas	in. (mm)	φ5/8 (φ15.9) (flare connection)		φ5/8 (φ15.9) (flare connection)	
	Drain	in. (mm)	VP13 (external dia. 11/16 (18), internal dia. 1/2 (13))		VP13 (external dia. 11/16 (18), internal dia. 1/2 (13))	
Remote controller (accessory)	Wired		BRC1E73 / BRC1H71W / DTST-ONE-ADA-A		BRC1E73 / BRC1H71W / DTST-ONE-ADA-A	
	Wireless		BRC7E818		BRC7E818	
Outdoor unit			RZR18TBVJUA		RZR24TBVJUA	
Casing/color			Ivory white		Ivory white	
Dimensions	H × W × D	in. (mm)	39 × 37 × 12-5/8 (990 × 940 × 320)		39 × 37 × 12-5/8 (990 × 940 × 320)	
Coil	Type		Cross fin coil		Cross fin coil	
Compressor	Type		Hermetically sealed swing type		Hermetically sealed swing type	
	Motor output	kW	1.9		1.9	
Fan	Type		Propeller fan		Propeller fan	
	Motor output	W	200		200	
	Airflow rate	cfm (m ³ /min)	2,682 (76)		2,682 (76)	
Weight	lbs (kg)		172 (78)		172 (78)	
Piping connections	Liquid	in. (mm)	φ3/8 (φ9.5) (flare connection)		φ3/8 (φ9.5) (flare connection)	
	Gas	in. (mm)	φ5/8 (φ15.9) (flare connection)		φ5/8 (φ15.9) (flare connection)	
	Drain	in. (mm)	φ1 (φ26) (hole)		φ1 (φ26) (hole)	
Safety devices			High pressure switch, Outdoor fan driver overload protector, Inverter overload protector, Fusible plug, Fuse		High pressure switch, Outdoor fan driver overload protector, Inverter overload protector, Fusible plug, Fuse	
Capacity step	%		14-100		14-100	
Refrigerant control			Electronic expansion valve		Electronic expansion valve	
Ref. piping	Standard length	ft (m)	25 (7.6)		25 (7.6)	
	Max. length	ft (m)	164 (50)		164 (50)	
	Max. height difference	ft (m)	98 (30)		98 (30)	
Refrigerant	Type		R410A		R410A	
	Charge	lbs (kg)	6.4 (2.9)		6.4 (2.9)	
Ref. oil	Type		DAPHNE FVC50K		DAPHNE FVC50K	
	Charge	L	1.08		1.08	

Note:

- ★1. Indoor temp.: 80°FDB (26.7°CDB), 67°FWB (19.4°CWB) / Outdoor temp.: 95°FDB (35.0°CDB) / Equivalent piping length: 25 ft. (7.6 m), height difference: 0 ft. (0 m).
- ★2. Capacities are net, including a deduction for cooling for indoor fan motor heat.

C: 4D143006A

4.1.3 FBQ HSP concealed ducted unit

Model	Indoor unit		FBQ18TBVJU		FBQ24TBVJU	
	Outdoor unit		RZR18TBVJUA		RZR24TBVJUA	
Power supply			1 phase, 208/230 V, 60 Hz		1 phase, 208/230 V, 60 Hz	
Cooling capacity ★1, ★2		Btu/h (kW)	17,700 (5.2)		23,400 (6.9)	
EER2 (rated)		Btu/h-W	12.5		10.5	
SEER2 (rated)			15.5		15.4	
Indoor unit			FBQ18TBVJU		FBQ24TBVJU	
Casing/color			Galvanized steel plate		Galvanized steel plate	
Dimensions	H × W × D	in. (mm)	9-11/16 × 39-3/8 × 31-1/2 (245 × 1,000 × 800)		9-11/16 × 39-3/8 × 31-1/2 (245 × 1,000 × 800)	
Coil	Type		Cross fin coil		Cross fin coil	
	Type		Sirocco fan		Sirocco fan	
Fan	Motor output	W	230		230	
	Airflow rate (H / M / L)	cfm (m ³ /min)	635 / 565 / 512 (18.0 / 16.0 / 14.5)		742 / 635 / 565 (21.0 / 18.0 / 16.0)	
	External static pressure	in.H ₂ O (Pa)	Standard 0.40 <0.80-0.20> (100 <200-50>) ★3		Standard 0.40 <0.80-0.20> (100 <200-50>) ★3	
Air filter			— ★4		— ★4	
Weight		lbs (kg)	77 (35)		82 (37)	
Piping connections	Liquid	in. (mm)	φ3/8 (φ9.5) (flare connection)		φ3/8 (φ9.5) (flare connection)	
	Gas	in. (mm)	φ5/8 (φ15.9) (flare connection)		φ5/8 (φ15.9) (flare connection)	
	Drain	in. (mm)	VP25 (external dia. 1-1/4 (32), internal dia. 1 (26))		VP25 (external dia. 1-1/4 (32), internal dia. 1 (26))	
Remote controller (accessory)	Wired		BRC1E73 / BRC1H71W / DTST-ONE-ADA-A		BRC1E73 / BRC1H71W / DTST-ONE-ADA-A	
	Wireless		BRC082A43		BRC082A43	
Outdoor unit			RZR18TBVJUA		RZR24TBVJUA	
Casing/color			Ivory white		Ivory white	
Dimensions	H × W × D	in. (mm)	39 × 37 × 12-5/8 (990 × 940 × 320)		39 × 37 × 12-5/8 (990 × 940 × 320)	
Coil	Type		Cross fin coil		Cross fin coil	
	Type		Hermetically sealed swing type		Hermetically sealed swing type	
Compressor	Motor output	kW	1.9		1.9	
	Type		Propeller fan		Propeller fan	
Fan	Motor output	W	200		200	
	Airflow rate	cfm (m ³ /min)	2,682 (76)		2,682 (76)	
	Weight		lbs (kg)	172 (78)		172 (78)
Piping connections	Liquid	in. (mm)	φ3/8 (φ9.5) (flare connection)		φ3/8 (φ9.5) (flare connection)	
	Gas	in. (mm)	φ5/8 (φ15.9) (flare connection)		φ5/8 (φ15.9) (flare connection)	
	Drain	in. (mm)	φ1 (φ26) (hole)		φ1 (φ26) (hole)	
Safety devices			High pressure switch, Outdoor fan driver overload protector, Inverter overload protector, Fusible plug, Fuse		High pressure switch, Outdoor fan driver overload protector, Inverter overload protector, Fusible plug, Fuse	
Capacity step		%	14-100		14-100	
Refrigerant control			Electronic expansion valve		Electronic expansion valve	
Ref. piping	Standard length	ft (m)	25 (7.6)		25 (7.6)	
	Max. length	ft (m)	164 (50)		164 (50)	
	Max. height difference	ft (m)	98 (30)		98 (30)	
Refrigerant	Type		R410A		R410A	
	Charge	lbs (kg)	6.4 (2.9)		6.4 (2.9)	
Ref. oil	Type		DAPHNE FVC50K		DAPHNE FVC50K	
	Charge	L	1.08		1.08	

Note:

- ★1. Indoor temp.: 80°FDB (26.7°CDB), 67°FWB (19.4°CWB) / Outdoor temp.: 95°FDB (35.0°CDB) / Equivalent piping length: 25 ft. (7.6 m), height difference: 0 ft. (0 m).
- ★2. Capacities are net, including a deduction for cooling for indoor fan motor heat.
- ★3. External static pressure is changeable in 14 stages within the < > range by remote controller.
- ★4. Air filter is not standard accessory, but please mount it in the duct system of the suction side.
Select its dust collection efficiency (gravity method) 50% or more.

C: 4D143009A

HSP concealed ducted unit, continued

Model	Indoor unit		FBQ30TBVJU		FBQ36TBVJU	
	Outdoor unit		RZR30TBVJUA		RZR36TBVJUA	
Power supply			1 phase, 208/230 V, 60 Hz		1 phase, 208/230 V, 60 Hz	
Cooling capacity ★1, ★2	Btu/h (kW)		28,400 (8.3)		35,000 (10.3)	
EER2 (rated)	Btu/h-W		12.2		11.7	
SEER2 (rated)			16.5		16.9	
Indoor unit			FBQ30TBVJU		FBQ36TBVJU	
Casing/color			Galvanized steel plate		Galvanized steel plate	
Dimensions	H × W × D	in. (mm)	9-11/16 × 55-1/8 × 31-1/2 (245 × 1,400 × 800)		9-11/16 × 55-1/8 × 31-1/2 (245 × 1,400 × 800)	
Coil	Type		Cross fin coil		Cross fin coil	
Fan	Type		Sirocco fan		Sirocco fan	
	Motor output	W	364		364	
	Airflow rate (H / M / L)	cfm (m ³ /min)	1,094 / 847 / 795 (31.0 / 24.0 / 22.5)		1,130 / 953 / 795 (32.0 / 27.0 / 22.5)	
	External static pressure	in.H ₂ O (Pa)	Standard 0.40 <0.80-0.20> (100 <200-50>) ★3		Standard 0.40 <0.80-0.20> (100 <200-50>) ★3	
Air filter			— ★4		— ★4	
Weight	lbs (kg)		101 (46)		101 (46)	
Piping connections	Liquid	in. (mm)	φ3/8 (φ9.5) (flare connection)		φ3/8 (φ9.5) (flare connection)	
	Gas	in. (mm)	φ5/8 (φ15.9) (flare connection)		φ5/8 (φ15.9) (flare connection)	
	Drain	in. (mm)	VP25 (external dia. 1-1/4 (32), internal dia. 1 (26))		VP25 (external dia. 1-1/4 (32), internal dia. 1 (26))	
Remote controller (accessory)	Wired		BRC1E73 / BRC1H71W / DTST-ONE-ADA-A		BRC1E73 / BRC1H71W / DTST-ONE-ADA-A	
	Wireless		BRC082A43		BRC082A43	
Outdoor unit			RZR30TBVJUA		RZR36TBVJUA	
Casing/color			Ivory white		Ivory white	
Dimensions	H × W × D	in. (mm)	52-15/16 × 35-7/16 × 12-5/8 (1,345 × 900 × 320)		52-15/16 × 35-7/16 × 12-5/8 (1,345 × 900 × 320)	
Coil	Type		Cross fin coil		Cross fin coil	
Compressor	Type		Hermetically sealed swing type		Hermetically sealed swing type	
	Motor output	kW	3.5		3.5	
Fan	Type		Propeller fan		Propeller fan	
	Motor output	W	70 × 2		70 × 2	
	Airflow rate	cfm (m ³ /min)	3,741 (106)		3,741 (106)	
Weight	lbs (kg)		225 (102)		225 (102)	
Piping connections	Liquid	in. (mm)	φ3/8 (φ9.5) (flare connection)		φ3/8 (φ9.5) (flare connection)	
	Gas	in. (mm)	φ5/8 (φ15.9) (flare connection)		φ5/8 (φ15.9) (flare connection)	
	Drain	in. (mm)	φ1 (φ26) (hole)		φ1 (φ26) (hole)	
Safety devices			High pressure switch, Outdoor fan driver overload protector, Inverter overload protector, Fusible plug, Fuse		High pressure switch, Outdoor fan driver overload protector, Inverter overload protector, Fusible plug, Fuse	
Capacity step	%		14-100		14-100	
Refrigerant control			Electronic expansion valve		Electronic expansion valve	
Ref. piping	Standard length	ft (m)	25 (7.6)		25 (7.6)	
	Max. length	ft (m)	230 (70)		230 (70)	
	Max. height difference	ft (m)	98 (30)		98 (30)	
Refrigerant	Type		R410A		R410A	
	Charge	lbs (kg)	7.9 (3.6)		7.9 (3.6)	
Ref. oil	Type		DAPHNE FVC50K		DAPHNE FVC50K	
	Charge	L	1.52		1.52	

Note:

- ★1. Indoor temp.: 80°FDB (26.7°CDB), 67°FWB (19.4°CWB) / Outdoor temp.: 95°FDB (35.0°CDB) / Equivalent piping length: 25 ft. (7.6 m), height difference: 0 ft. (0 m).
- ★2. Capacities are net, including a deduction for cooling for indoor fan motor heat.
- ★3. External static pressure is changeable in 14 stages within the < > range by remote controller.
- ★4. Air filter is not standard accessory, but please mount it in the duct system of the suction side.
Select its dust collection efficiency (gravity method) 50% or more.

C: 4D143010A

HSP concealed ducted unit, continued

Model	Indoor unit		FBQ42TBVJU		FBQ48TBVJU	
	Outdoor unit		RZR42TBVJUA		RZR48TBVJUA	
Power supply			1 phase, 208/230 V, 60 Hz		1 phase, 208/230 V, 60 Hz	
Cooling capacity ★1, ★2	Btu/h (kW)		40,000 (11.7)		46,500 (13.6)	
EER2 (rated)	Btu/h-W		10.3		8.3	
SEER2 (rated)			15.6		15.3	
Indoor unit			FBQ42TBVJU		FBQ48TBVJU	
Casing/color			Galvanized steel plate		Galvanized steel plate	
Dimensions	H × W × D	in. (mm)	9-11/16 × 55-1/8 × 31-1/2 (245 × 1,400 × 800)		9-11/16 × 55-1/8 × 31-1/2 (245 × 1,400 × 800)	
Coil	Type		Cross fin coil		Cross fin coil	
Fan	Type		Sirocco fan		Sirocco fan	
	Motor output	W	364		364	
	Airflow rate (H / M / L)	cfm (m ³ /min)	1,377 / 1,130 / 918 (39.0 / 32.0 / 26.0)		1,377 / 1,130 / 918 (39.0 / 32.0 / 26.0)	
	External static pressure	in.H ₂ O (Pa)	Standard 0.40 <0.80-0.20> (100 <200-50>) ★3		Standard 0.40 <0.80-0.20> (100 <200-50>) ★3	
Air filter			— ★4		— ★4	
Weight	lbs (kg)		104 (47)		104 (47)	
Piping connections	Liquid	in. (mm)	φ3/8 (φ9.5) (flare connection)		φ3/8 (φ9.5) (flare connection)	
	Gas	in. (mm)	φ5/8 (φ15.9) (flare connection)		φ5/8 (φ15.9) (flare connection)	
	Drain	in. (mm)	VP25 (external dia. 1-1/4 (32), internal dia. 1 (26))		VP25 (external dia. 1-1/4 (32), internal dia. 1 (26))	
Remote controller (accessory)	Wired		BRC1E73 / BRC1H71W / DTST-ONE-ADA-A		BRC1E73 / BRC1H71W / DTST-ONE-ADA-A	
	Wireless		BRC082A43		BRC082A43	
Outdoor unit			RZR42TBVJUA		RZR48TBVJUA	
Casing/color			Ivory white		Ivory white	
Dimensions	H × W × D	in. (mm)	52-15/16 × 35-7/16 × 12-5/8 (1,345 × 900 × 320)		52-15/16 × 35-7/16 × 12-5/8 (1,345 × 900 × 320)	
Coil	Type		Cross fin coil		Cross fin coil	
Compressor	Type		Hermetically sealed swing type		Hermetically sealed swing type	
	Motor output	kW	3.5		3.5	
Fan	Type		Propeller fan		Propeller fan	
	Motor output	W	70 × 2		70 × 2	
	Airflow rate	cfm (m ³ /min)	3,741 (106)		3,741 (106)	
Weight	lbs (kg)		225 (102)		225 (102)	
Piping connections	Liquid	in. (mm)	φ3/8 (φ9.5) (flare connection)		φ3/8 (φ9.5) (flare connection)	
	Gas	in. (mm)	φ5/8 (φ15.9) (flare connection)		φ5/8 (φ15.9) (flare connection)	
	Drain	in. (mm)	φ1 (φ26) (hole)		φ1 (φ26) (hole)	
Safety devices			High pressure switch, Outdoor fan driver overload protector, Inverter overload protector, Fusible plug, Fuse		High pressure switch, Outdoor fan driver overload protector, Inverter overload protector, Fusible plug, Fuse	
Capacity step	%		14-100		14-100	
Refrigerant control			Electronic expansion valve		Electronic expansion valve	
Ref. piping	Standard length	ft (m)	25 (7.6)		25 (7.6)	
	Max. length	ft (m)	230 (70)		230 (70)	
	Max. height difference	ft (m)	98 (30)		98 (30)	
Refrigerant	Type		R410A		R410A	
	Charge	lbs (kg)	7.9 (3.6)		7.9 (3.6)	
Ref. oil	Type		DAPHNE FVC50K		DAPHNE FVC50K	
	Charge	L	1.52		1.52	

Note:

- ★1. Indoor temp.: 80°FDB (26.7°CDB), 67°FWB (19.4°CWB) / Outdoor temp.: 95°FDB (35.0°CDB) / Equivalent piping length: 25 ft. (7.6 m), height difference: 0 ft. (0 m).
- ★2. Capacities are net, including a deduction for cooling for indoor fan motor heat.
- ★3. External static pressure is changeable in 14 stages within the < > range by remote controller.
- ★4. Air filter is not standard accessory, but please mount it in the duct system of the suction side.
Select its dust collection efficiency (gravity method) 50% or more.

C: 4D143010A

4.1.4 FTQ

Air handling unit

Model	Indoor unit		with factory disconnect	FTQ18TAVJUD	FTQ24TAVJUD
			without factory disconnect	FTQ18TAVJUA	FTQ24TAVJUA
	Outdoor unit			RZR18TBVJUA	RZR24TBVJUA
Power supply				1 phase, 208/230 V, 60 Hz	1 phase, 208/230 V, 60 Hz
Cooling capacity ★1, ★2		Btu/h (kW)		17,200 (5.0)	23,400 (6.9)
EER2 (rated)		Btu/h-W		11.7	9.9
SEER2 (rated)				15.6	16.2
Indoor unit			with factory disconnect	FTQ18TAVJUD	FTQ24TAVJUD
			without factory disconnect	FTQ18TAVJUA	FTQ24TAVJUA
Casing/color				Daikin Slate Gray	Daikin Slate Gray
Dimensions	H × W × D	in. (mm)		45 × 17.5 × 21 (1,143 × 445 × 533)	45 × 17.5 × 21 (1,143 × 445 × 533)
Coil	Type			Cross fin coil	Cross fin coil
	Type			Sirocco FC Centrifugal	Sirocco FC Centrifugal
Fan	Motor output	HP		1/2	1/2
	Airflow rate (H / M / L)	cfm (m ³ /min)		600 / 510 / 420 (17.0 / 14.4 / 11.9)	800 / 680 / 560 (22.7 / 19.3 / 15.9)
	External static pressure	in. w.g.		0.1" - 0.9"	0.1" - 0.9"
Air filter				— ★3	— ★3
Weight		lbs (kg)		115 (52.2)	115 (52.2)
Piping connections	Liquid	in. (mm)		φ3/8 (φ9.5) (brazing connection)	φ3/8 (φ9.5) (brazing connection)
	Gas	in. (mm)		φ5/8 (φ15.9) (brazing connection)	φ5/8 (φ15.9) (brazing connection)
	Drain	in. (mm)		3/4" (19.1)	3/4" (19.1)
Remote controller (accessory)	Wired			BRC1E73 / BRC1H71W / DTST-ONE-ADA-A	BRC1E73 / BRC1H71W / DTST-ONE-ADA-A
	Wireless			BRC4C82	BRC4C82
Outdoor unit				RZR18TBVJUA	RZR24TBVJUA
Casing/color				Ivory white	Ivory white
Dimensions	H × W × D	in. (mm)		39 × 37 × 12-5/8 (990 × 940 × 320)	39 × 37 × 12-5/8 (990 × 940 × 320)
Coil	Type			Cross fin coil	Cross fin coil
	Type			Hermetically sealed swing type	Hermetically sealed swing type
Compressor	Motor output	kW		1.9	1.9
	Type			Propeller fan	Propeller fan
Fan	Motor output	W		200	200
	Airflow rate	cfm (m ³ /min)		2,682 (76)	2,682 (76)
	Weight		lbs (kg)		172 (78)
Piping connections	Liquid	in. (mm)		φ3/8 (φ9.5) (flare connection)	φ3/8 (φ9.5) (flare connection)
	Gas	in. (mm)		φ5/8 (φ15.9) (flare connection)	φ5/8 (φ15.9) (flare connection)
	Drain	in. (mm)		φ1 (φ26) (hole)	φ1 (φ26) (hole)
Safety devices				High pressure switch, Outdoor fan driver overload protector, Inverter overload protector, Fusible plug, Fuse	High pressure switch, Outdoor fan driver overload protector, Inverter overload protector, Fusible plug, Fuse
Capacity step		%		14-100	14-100
Refrigerant control				Electronic expansion valve	Electronic expansion valve
Ref. piping	Standard length	ft (m)		25 (7.6)	25 (7.6)
	Max. length	ft (m)		164 (50)	164 (50)
	Max. height difference	ft (m)		98 (30)	98 (30)
Refrigerant	Type			R410A	R410A
	Charge	lbs (kg)		6.4 (2.9)	6.4 (2.9)
Ref. oil	Type			DAPHNE FVC50K	DAPHNE FVC50K
	Charge	L		1.08	1.08

Note:

- ★1. Indoor temp.: 80°FDB (26.7°CDB), 67°FWB (19.4°CWB) / Outdoor temp.: 95°FDB (35.0°CDB) / Equivalent piping length: 25 ft. (7.6 m), height difference: 0 ft. (0 m).
- ★2. Capacities are net, including a deduction for cooling for indoor fan motor heat.
- ★3. Air filter is not standard accessory (field supply parts), but please mount it in the duct system of the suction side.

Air handling unit, continued

Model	Indoor unit		with factory disconnect	FTQ30TAVJUD	FTQ36TAVJUD
			without factory disconnect	FTQ30TAVJUA	FTQ36TAVJUA
	Outdoor unit			RZR30TBVJUA	RZR36TBVJUA
Power supply				1 phase, 208/230 V, 60 Hz	1 phase, 208/230 V, 60 Hz
Cooling capacity ★1, ★2		Btu/h (kW)		29,500 (8.6)	35,000 (10.3)
EER2 (rated)		Btu/h-W		11.9	11.2
SEER2 (rated)				15.6	16.4
Indoor unit			with factory disconnect	FTQ30TAVJUD	FTQ36TAVJUD
			without factory disconnect	FTQ30TAVJUA	FTQ36TAVJUA
Casing/color				Daikin Slate Gray	Daikin Slate Gray
Dimensions	H × W × D	in. (mm)		45 × 17.5 × 21 (1,143 × 445 × 533)	45 × 17.5 × 21 (1,143 × 445 × 533)
Coil	Type			Cross fin coil	Cross fin coil
	Type			Sirocco FC Centrifugal	Sirocco FC Centrifugal
Fan	Motor output	HP		1/2	1/2
	Airflow rate (H / M / L)	cfm (m ³ /min)		1,000 / 850 / 700 (28.3 / 24.1 / 19.8)	1,050 / 900 / 750 (29.7 / 25.5 / 21.2)
	External static pressure	in. w.g.		0.1" - 0.9"	0.1" - 0.9"
Air filter				— ★3	— ★3
Weight		lbs (kg)		115 (52.2)	140 (63.5)
Piping connections	Liquid	in. (mm)		φ3/8 (φ9.5) (brazing connection)	φ3/8 (φ9.5) (brazing connection)
	Gas	in. (mm)		φ5/8 (φ15.9) (brazing connection)	φ5/8 (φ15.9) (brazing connection)
	Drain	in. (mm)		3/4" (19.1)	3/4" (19.1)
Remote controller (accessory)	Wired			BRC1E73 / BRC1H71W / DTST-ONE-ADA-A	BRC1E73 / BRC1H71W / DTST-ONE-ADA-A
	Wireless			BRC4C82	BRC4C82
Outdoor unit				RZR30TBVJUA	RZR36TBVJUA
Casing/color				Ivory white	Ivory white
Dimensions	H × W × D	in. (mm)		52-15/16 × 35-7/16 × 12-5/8 (1,345 × 900 × 320)	52-15/16 × 35-7/16 × 12-5/8 (1,345 × 900 × 320)
Coil	Type			Cross fin coil	Cross fin coil
	Type			Hermetically sealed swing type	Hermetically sealed swing type
Compressor	Motor output	kW		3.5	3.5
	Type			Propeller fan	Propeller fan
Fan	Motor output	W		70 × 2	70 × 2
	Airflow rate	cfm (m ³ /min)		3,741 (106)	3,741 (106)
	Weight		lbs (kg)		225 (102)
Piping connections	Liquid	in. (mm)		φ3/8 (φ9.5) (flare connection)	φ3/8 (φ9.5) (flare connection)
	Gas	in. (mm)		φ5/8 (φ15.9) (flare connection)	φ5/8 (φ15.9) (flare connection)
	Drain	in. (mm)		φ1 (φ26) (hole)	φ1 (φ26) (hole)
Safety devices				High pressure switch, Outdoor fan driver overload protector, Inverter overload protector, Fusible plug, Fuse	High pressure switch, Outdoor fan driver overload protector, Inverter overload protector, Fusible plug, Fuse
Capacity step		%		14-100	14-100
Refrigerant control				Electronic expansion valve	Electronic expansion valve
Ref. piping	Standard length	ft (m)		25 (7.6)	25 (7.6)
	Max. length	ft (m)		230 (70)	230 (70)
	Max. height difference	ft (m)		98 (30)	98 (30)
Refrigerant	Type			R410A	R410A
	Charge	lbs (kg)		7.9 (3.6)	7.9 (3.6)
Ref. oil	Type			DAPHNE FVC50K	DAPHNE FVC50K
	Charge	L		1.52	1.52

Note:

- ★1. Indoor temp.: 80°FDB (26.7°CDB), 67°FWB (19.4°CWB) / Outdoor temp.: 95°FDB (35.0°CDB) / Equivalent piping length: 25 ft. (7.6 m), height difference: 0 ft. (0 m).
- ★2. Capacities are net, including a deduction for cooling for indoor fan motor heat.
- ★3. Air filter is not standard accessory (field supply parts), but please mount it in the duct system of the suction side.

Air handling unit, continued

Model	Indoor unit		with factory disconnect	FTQ42TAVJUD	FTQ48TAVJUD
			without factory disconnect	FTQ42TAVJUA	FTQ48TAVJUA
	Outdoor unit			RZR42TBVJUA	RZR48TBVJUA
Power supply				1 phase, 208/230 V, 60 Hz	1 phase, 208/230 V, 60 Hz
Cooling capacity ★1, ★2		Btu/h (kW)		40,500 (11.9)	47,000 (13.8)
EER2 (rated)		Btu/h-W		10.6	9.1
SEER2 (rated)				16.0	15.3
Indoor unit			with factory disconnect	FTQ42TAVJUD	FTQ48TAVJUD
			without factory disconnect	FTQ42TAVJUA	FTQ48TAVJUA
Casing/color				Daikin Slate Gray	Daikin Slate Gray
Dimensions	H × W × D	in. (mm)		53.43 × 21 × 21 (1,357 × 533 × 533)	53.43 × 21 × 21 (1,357 × 533 × 533)
Coil	Type			Cross fin coil	Cross fin coil
	Type			Sirocco FC Centrifugal	Sirocco FC Centrifugal
Fan	Motor output	HP		3/4	3/4
	Airflow rate (H / M / L)	cfm (m ³ /min)		1,400 / 1,190 / 980 (39.7 / 33.7 / 27.8)	1,520 / 1,290 / 1,060 (43.1 / 36.5 / 30.0)
	External static pressure	in. w.g.		0.1" - 0.9"	0.1" - 0.9"
Air filter				— ★3	— ★3
Weight		lbs (kg)		150 (68)	150 (68)
Piping connections	Liquid	in. (mm)		φ3/8 (φ9.5) (brazing connection)	φ3/8 (φ9.5) (brazing connection)
	Gas	in. (mm)		φ5/8 (φ15.9) (brazing connection)	φ5/8 (φ15.9) (brazing connection)
	Drain	in. (mm)		3/4" (19.1)	3/4" (19.1)
Remote controller (accessory)	Wired			BRC1E73 / BRC1H71W / DTST-ONE-ADA-A	BRC1E73 / BRC1H71W / DTST-ONE-ADA-A
	Wireless			BRC4C82	BRC4C82
Outdoor unit				RZR42TBVJUA	RZR48TBVJUA
Casing/color				Ivory white	Ivory white
Dimensions	H × W × D	in. (mm)		52-15/16 × 35-7/16 × 12-5/8 (1,345 × 900 × 320)	52-15/16 × 35-7/16 × 12-5/8 (1,345 × 900 × 320)
Coil	Type			Cross fin coil	Cross fin coil
	Type			Hermetically sealed swing type	Hermetically sealed swing type
Compressor	Motor output	kW		3.5	3.5
	Type			Propeller fan	Propeller fan
Fan	Motor output	W		70 × 2	70 × 2
	Airflow rate	cfm (m ³ /min)		3,741 (106)	3,741 (106)
	Weight		lbs (kg)		225 (102)
Piping connections	Liquid	in. (mm)		φ3/8 (φ9.5) (flare connection)	φ3/8 (φ9.5) (flare connection)
	Gas	in. (mm)		φ5/8 (φ15.9) (flare connection)	φ5/8 (φ15.9) (flare connection)
	Drain	in. (mm)		φ1 (φ26) (hole)	φ1 (φ26) (hole)
Safety devices				High pressure switch, Outdoor fan driver overload protector, Inverter overload protector, Fusible plug, Fuse	High pressure switch, Outdoor fan driver overload protector, Inverter overload protector, Fusible plug, Fuse
Capacity step		%		14-100	14-100
Refrigerant control				Electronic expansion valve	Electronic expansion valve
Ref. piping	Standard length	ft (m)		25 (7.6)	25 (7.6)
	Max. length	ft (m)		230 (70)	230 (70)
	Max. height difference	ft (m)		98 (30)	98 (30)
Refrigerant	Type			R410A	R410A
	Charge	lbs (kg)		7.9 (3.6)	7.9 (3.6)
Ref. oil	Type			DAPHNE FVC50K	DAPHNE FVC50K
	Charge	L		1.52	1.52

Note:

- ★1. Indoor temp.: 80°FDB (26.7°CDB), 67°FWB (19.4°CWB) / Outdoor temp.: 95°FDB (35.0°CDB) / Equivalent piping length: 25 ft. (7.6 m), height difference: 0 ft. (0 m).
- ★2. Capacities are net, including a deduction for cooling for indoor fan motor heat.
- ★3. Air filter is not standard accessory (field supply parts), but please mount it in the duct system of the suction side.

4.2 Heat Pump

4.2.1 FCQ

Ceiling mounted cassette type (round flow with sensing)

Model		Indoor unit		FCQ18AAVJU		FCQ24AAVJU	
		Outdoor unit		RZQ18TBVJUA		RZQ24TBVJUA	
Power supply				1 phase, 208/230 V, 60 Hz		1 phase, 208/230 V, 60 Hz	
Cooling capacity ★1, ★4		Btu/h (kW)		18,000 (5.3)		24,000 (7.0)	
Heating capacity ★2, ★4		Btu/h (kW)		20,000 (5.9)		27,000 (7.9)	
Heating capacity ★3, ★4		Btu/h (kW)		12,300 (3.6)		18,000 (5.3)	
EER2 (rated)		Btu/h-W		13.0		12.0	
SEER2 (rated)				18.5		18.6	
HSPF2 (rated)				9.2		9.1	
Indoor unit				FCQ18AAVJU		FCQ24AAVJU	
Casing/color				Galvanized steel plate		Galvanized steel plate	
Dimensions	H × W × D	in. (mm)		9-11/16 × 33-1/16 × 33-1/16 (246 × 840 × 840)		9-11/16 × 33-1/16 × 33-1/16 (246 × 840 × 840)	
Coil	Type			Cross fin coil		Cross fin coil	
	Type			Turbo fan		Turbo fan	
Fan	Motor output		W	53		53	
	Airflow rate (H / M / L)		cfm (m ³ /min)	742 / 618 / 477 (21.0 / 17.5 / 13.5)		777 / 618 / 477 (22.0 / 17.5 / 13.5)	
	External static pressure		in.H ₂ O (Pa)	—		—	
Air filter				—		—	
Weight		lbs (kg)		51 (23)		51 (23)	
Piping connections	Liquid	in. (mm)		φ3/8 (φ9.5) (flare connection)		φ3/8 (φ9.5) (flare connection)	
	Gas	in. (mm)		φ5/8 (φ15.9) (flare connection)		φ5/8 (φ15.9) (flare connection)	
	Drain	in. (mm)		VP25 (external dia. 1-1/4 (32), internal dia. 1 (26))		VP25 (external dia. 1-1/4 (32), internal dia. 1 (26))	
Remote controller (accessory)	Wired			BRC1E73 / BRC1H71W / DTST-ONE-ADA-A		BRC1E73 / BRC1H71W / DTST-ONE-ADA-A	
	Wireless			—		—	
Decoration panel (accessory)	Model			BYCQ54EEFU / BYCQ54EEGFU		BYCQ54EEFU / BYCQ54EEGFU	
	Color			Fresh white		Fresh white	
	Dimensions	H × W × D	in. (mm)	2 × 37-3/8 × 37-3/8 / 5-1/8 × 37-3/8 × 37-3/8 (50 × 950 × 950 / 130 × 950 × 950)		2 × 37-3/8 × 37-3/8 / 5-1/8 × 37-3/8 × 37-3/8 (50 × 950 × 950 / 130 × 950 × 950)	
	Air filter			Resin net (with mold resistance)		Resin net (with mold resistance)	
	Weight		lbs (kg)		12 (5.5) / 22 (10.0)		12 (5.5) / 22 (10.0)
Outdoor unit				RZQ18TBVJUA		RZQ24TBVJUA	
Casing/color				Ivory white		Ivory white	
Dimensions	H × W × D	in. (mm)		39 × 37 × 12-5/8 (990 × 940 × 320)		39 × 37 × 12-5/8 (990 × 940 × 320)	
Coil	Type			Cross fin coil		Cross fin coil	
	Type			Hermetically sealed swing type		Hermetically sealed swing type	
Compressor	Motor output		kW	1.9		1.9	
	Type			Propeller fan		Propeller fan	
Fan	Motor output		W	200		200	
	Airflow rate		cfm (m ³ /min)	2,682 (76)		2,682 (76)	
Weight		lbs (kg)		172 (78)		172 (78)	
Piping connections	Liquid	in. (mm)		φ3/8 (φ9.5) (flare connection)		φ3/8 (φ9.5) (flare connection)	
	Gas	in. (mm)		φ5/8 (φ15.9) (flare connection)		φ5/8 (φ15.9) (flare connection)	
	Drain	in. (mm)		φ1 (φ26) (hole)		φ1 (φ26) (hole)	
Safety devices				High pressure switch, Outdoor fan driver overload protector, Inverter overload protector, Fusible plug, Fuse		High pressure switch, Outdoor fan driver overload protector, Inverter overload protector, Fusible plug, Fuse	
Capacity step		%		14-100		14-100	
Refrigerant control				Electronic expansion valve		Electronic expansion valve	
Ref. piping	Standard length		ft (m)	25 (7.6)		25 (7.6)	
	Max. length		ft (m)	164 (50)		164 (50)	
	Max. height difference		ft (m)	98 (30)		98 (30)	
Refrigerant	Type			R410A		R410A	
	Charge		lbs (kg)	6.4 (2.9)		6.4 (2.9)	
Ref. oil	Type			DAPHNE FVC50K		DAPHNE FVC50K	
	Charge		L	1.08		1.08	

Note:

- ★1. Indoor temp.: 80°FDB (26.7°CDB), 67°FWB (19.4°CWB) / Outdoor temp.: 95°FDB (35.0°CDB) / Equivalent piping length: 25 ft. (7.6 m), height difference: 0 ft. (0 m).
- ★2. Indoor temp.: 70°FDB (21.1°CDB) / Outdoor temp.: 47°FDB (8.3°CDB), 43°FWB (6.1°CWB) / Equivalent piping length: 25 ft. (7.6 m), height difference: 0 ft. (0 m).
- ★3. Indoor temp.: 70°FDB (21.1°CDB) / Outdoor temp.: 17°FDB (-8.3°CDB), 15°FWB (-9.4°CWB) / Equivalent piping length: 25 ft. (7.6 m), height difference: 0 ft. (0 m).
- ★4. Capacities are net, including a deduction for cooling (an addition for heating) for indoor fan motor heat.

C: 4D143001B

Ceiling mounted cassette type (round flow with sensing), continued

Model	Indoor unit		FCQ30AAVJU		FCQ36AAVJU	
	Outdoor unit		RZQ30TBVJUA		RZQ36TBVJUA	
Power supply			1 phase, 208/230 V, 60 Hz		1 phase, 208/230 V, 60 Hz	
Cooling capacity ★1, ★4	Btu/h (kW)		30,000 (8.8)		36,000 (10.6)	
Heating capacity ★2, ★4	Btu/h (kW)		34,000 (10.0)		40,000 (11.7)	
Heating capacity ★3, ★4	Btu/h (kW)		22,800 (6.7)		26,200 (7.7)	
EER2 (rated)	Btu/h-W		13.0		12.1	
SEER2 (rated)			21.0		20.0	
HSPF2 (rated)			10.1		10.0	
Indoor unit			FCQ30AAVJU		FCQ36AAVJU	
Casing/color			Galvanized steel plate		Galvanized steel plate	
Dimensions	H × W × D	in. (mm)	11-11/32 × 33-1/16 × 33-1/16 (288 × 840 × 840)		11-11/32 × 33-1/16 × 33-1/16 (288 × 840 × 840)	
Fan	Type		Cross fin coil		Cross fin coil	
	Type		Turbo fan		Turbo fan	
	Motor output	W	106		106	
	Airflow rate (H / M / L)	cfm (m ³ /min)	1,059 / 882 / 671 (30.0 / 25.0 / 19.0)		1,253 / 918 / 671 (35.5 / 26.0 / 19.0)	
External static pressure		in.H ₂ O (Pa)	—		—	
Air filter			—		—	
Weight		lbs (kg)	58 (26)		58 (26)	
Piping connections	Liquid	in. (mm)	φ3/8 (φ9.5) (flare connection)		φ3/8 (φ9.5) (flare connection)	
	Gas	in. (mm)	φ5/8 (φ15.9) (flare connection)		φ5/8 (φ15.9) (flare connection)	
	Drain	in. (mm)	VP25 (external dia. 1-1/4 (32), internal dia. 1 (26))		VP25 (external dia. 1-1/4 (32), internal dia. 1 (26))	
Remote controller (accessory)	Wired		BRC1E73 / BRC1H71W / DTST-ONE-ADA-A		BRC1E73 / BRC1H71W / DTST-ONE-ADA-A	
	Wireless		—		—	
Decoration panel (accessory)	Model		BYCQ54EEFU / BYCQ54EEGFU		BYCQ54EEFU / BYCQ54EEGFU	
	Color		Fresh white		Fresh white	
	Dimensions	H × W × D	2 × 37-3/8 × 37-3/8 / 5-1/8 × 37-3/8 × 37-3/8 (50 × 950 × 950 / 130 × 950 × 950)		2 × 37-3/8 × 37-3/8 / 5-1/8 × 37-3/8 × 37-3/8 (50 × 950 × 950 / 130 × 950 × 950)	
	Air filter		Resin net (with mold resistance)		Resin net (with mold resistance)	
	Weight		lbs (kg)	12 (5.5) / 22 (10.0)		12 (5.5) / 22 (10.0)
Outdoor unit			RZQ30TBVJUA		RZQ36TBVJUA	
Casing/color			Ivory white		Ivory white	
Dimensions	H × W × D	in. (mm)	52-15/16 × 35-7/16 × 12-5/8 (1,345 × 900 × 320)		52-15/16 × 35-7/16 × 12-5/8 (1,345 × 900 × 320)	
Coil	Type		Cross fin coil		Cross fin coil	
	Type		Hermetically sealed swing type		Hermetically sealed swing type	
Compressor	Motor output		kW		3.5	
	Type		Propeller fan		Propeller fan	
Fan	Motor output	W	70 × 2		70 × 2	
	Airflow rate	cfm (m ³ /min)	3,741 (106)		3,741 (106)	
Weight		lbs (kg)	225 (102)		225 (102)	
Piping connections	Liquid	in. (mm)	φ3/8 (φ9.5) (flare connection)		φ3/8 (φ9.5) (flare connection)	
	Gas	in. (mm)	φ5/8 (φ15.9) (flare connection)		φ5/8 (φ15.9) (flare connection)	
	Drain	in. (mm)	φ1 (φ26) (hole)		φ1 (φ26) (hole)	
Safety devices			High pressure switch, Outdoor fan driver overload protector, Inverter overload protector, Fusible plug, Fuse		High pressure switch, Outdoor fan driver overload protector, Inverter overload protector, Fusible plug, Fuse	
Capacity step		%	14-100		14-100	
Refrigerant control			Electronic expansion valve		Electronic expansion valve	
Ref. piping	Standard length		ft (m)		25 (7.6)	
	Max. length		ft (m)		230 (70)	
	Max. height difference		ft (m)		98 (30)	
Refrigerant	Type		R410A		R410A	
	Charge	lbs (kg)	7.9 (3.6)		7.9 (3.6)	
Ref. oil	Type		DAPHNE FVC50K		DAPHNE FVC50K	
	Charge	L	1.52		1.52	

Note:

- ★1. Indoor temp.: 80°FDB (26.7°CDB), 67°FWB (19.4°CWB) / Outdoor temp.: 95°FDB (35.0°CDB) / Equivalent piping length: 25 ft. (7.6 m), height difference: 0 ft. (0 m).
- ★2. Indoor temp.: 70°FDB (21.1°CDB) / Outdoor temp.: 47°FDB (8.3°CDB), 43°FWB (6.1°CWB) / Equivalent piping length: 25 ft. (7.6 m), height difference: 0 ft. (0 m).
- ★3. Indoor temp.: 70°FDB (21.1°CDB) / Outdoor temp.: 17°FDB (-8.3°CDB), 15°FWB (-9.4°CWB) / Equivalent piping length: 25 ft. (7.6 m), height difference: 0 ft. (0 m).
- ★4. Capacities are net, including a deduction for cooling (an addition for heating) for indoor fan motor heat.

C: 4D143002B

Ceiling mounted cassette type (round flow with sensing), continued

Model	Indoor unit		FCQ42AAVJU		FCQ48AAVJU		
	Outdoor unit		RZQ42TBVJUA		RZQ48TBVJUA		
Power supply			1 phase, 208/230 V, 60 Hz		1 phase, 208/230 V, 60 Hz		
Cooling capacity ★1, ★4	Btu/h (kW)		42,000 (12.3)		48,000 (14.1)		
Heating capacity ★2, ★4	Btu/h (kW)		47,000 (13.8)		54,000 (15.8)		
Heating capacity ★3, ★4	Btu/h (kW)		31,200 (9.1)		34,800 (10.2)		
EER2 (rated)	Btu/h-W		10.3		8.2		
SEER2 (rated)			18.9		18.0		
HSPF2 (rated)			10.2		10.3		
Indoor unit			FCQ42AAVJU		FCQ48AAVJU		
Casing/color			Galvanized steel plate		Galvanized steel plate		
Dimensions	H × W × D	in. (mm)	11-11/32 × 33-1/16 × 33-1/16 (288 × 840 × 840)		11-11/32 × 33-1/16 × 33-1/16 (288 × 840 × 840)		
Coil	Type		Cross fin coil		Cross fin coil		
	Type		Turbo fan		Turbo fan		
	Motor output	W	106		106		
	Airflow rate (H / M / L)	cfm (m ³ /min)	1,253 / 971 / 741 (35.5 / 27.5 / 21.0)		1,253 / 971 / 741 (35.5 / 27.5 / 21.0)		
External static pressure	in.H ₂ O (Pa)	—		—			
Air filter			—		—		
Weight	lbs (kg)		58 (26)		58 (26)		
Piping connections	Liquid	in. (mm)	φ3/8 (φ9.5) (flare connection)		φ3/8 (φ9.5) (flare connection)		
	Gas	in. (mm)	φ5/8 (φ15.9) (flare connection)		φ5/8 (φ15.9) (flare connection)		
	Drain	in. (mm)	VP25 (external dia. 1-1/4 (32), internal dia. 1 (26))		VP25 (external dia. 1-1/4 (32), internal dia. 1 (26))		
Remote controller (accessory)	Wired		BRC1E73 / BRC1H71W / DTST-ONE-ADA-A		BRC1E73 / BRC1H71W / DTST-ONE-ADA-A		
	Wireless		—		—		
Decoration panel (accessory)	Model		BYCQ54EEFU / BYCQ54EEGFU		BYCQ54EEFU / BYCQ54EEGFU		
	Color		Fresh white		Fresh white		
	Dimensions	H × W × D	in. (mm)	2 × 37-3/8 × 37-3/8 / 5-1/8 × 37-3/8 × 37-3/8 (50 × 950 × 950 / 130 × 950 × 950)		2 × 37-3/8 × 37-3/8 / 5-1/8 × 37-3/8 × 37-3/8 (50 × 950 × 950 / 130 × 950 × 950)	
	Air filter		Resin net (with mold resistance)		Resin net (with mold resistance)		
	Weight	lbs (kg)		12 (5.5) / 22 (10.0)		12 (5.5) / 22 (10.0)	
Outdoor unit			RZQ42TBVJUA		RZQ48TBVJUA		
Casing/color			Ivory white		Ivory white		
Dimensions	H × W × D	in. (mm)	52-15/16 × 35-7/16 × 12-5/8 (1,345 × 900 × 320)		52-15/16 × 35-7/16 × 12-5/8 (1,345 × 900 × 320)		
Coil	Type		Cross fin coil		Cross fin coil		
	Type		Hermetically sealed swing type		Hermetically sealed swing type		
Compressor	Motor output	kW	3.5		3.5		
	Type		Propeller fan		Propeller fan		
Fan	Motor output	W	70 × 2		70 × 2		
	Airflow rate	cfm (m ³ /min)	3,741 (106)		3,741 (106)		
	Type		Propeller fan		Propeller fan		
Weight	lbs (kg)		225 (102)		225 (102)		
Piping connections	Liquid	in. (mm)	φ3/8 (φ9.5) (flare connection)		φ3/8 (φ9.5) (flare connection)		
	Gas	in. (mm)	φ5/8 (φ15.9) (flare connection)		φ5/8 (φ15.9) (flare connection)		
	Drain	in. (mm)	φ1 (φ26) (hole)		φ1 (φ26) (hole)		
Safety devices			High pressure switch, Outdoor fan driver overload protector, Inverter overload protector, Fusible plug, Fuse		High pressure switch, Outdoor fan driver overload protector, Inverter overload protector, Fusible plug, Fuse		
Capacity step	%		14-100		14-100		
Refrigerant control			Electronic expansion valve		Electronic expansion valve		
Ref. piping	Standard length	ft (m)	25 (7.6)		25 (7.6)		
	Max. length	ft (m)	230 (70)		230 (70)		
	Max. height difference	ft (m)	98 (30)		98 (30)		
Refrigerant	Type		R410A		R410A		
	Charge	lbs (kg)	7.9 (3.6)		7.9 (3.6)		
Ref. oil	Type		DAPHNE FVC50K		DAPHNE FVC50K		
	Charge	L	1.52		1.52		

Note:

- ★1. Indoor temp.: 80°FDB (26.7°CDB), 67°FWB (19.4°CWB) / Outdoor temp.: 95°FDB (35.0°CDB) / Equivalent piping length: 25 ft. (7.6 m), height difference: 0 ft. (0 m).
- ★2. Indoor temp.: 70°FDB (21.1°CDB) / Outdoor temp.: 47°FDB (8.3°CDB), 43°FWB (6.1°CWB) / Equivalent piping length: 25 ft. (7.6 m), height difference: 0 ft. (0 m).
- ★3. Indoor temp.: 70°FDB (21.1°CDB) / Outdoor temp.: 17°FDB (-8.3°CDB), 15°FWB (-9.4°CWB) / Equivalent piping length: 25 ft. (7.6 m), height difference: 0 ft. (0 m).
- ★4. Capacities are net, including a deduction for cooling (an addition for heating) for indoor fan motor heat.

C: 4D143002B

4.2.2 FAQ

Wall mounted type

Model	Indoor unit		FAQ18TAVJU		FAQ24TAVJU	
	Outdoor unit		RZQ18TBVJUA		RZQ24TBVJUA	
Power supply			1 phase, 208/230 V, 60 Hz		1 phase, 208/230 V, 60 Hz	
Cooling capacity ★1, ★4	Btu/h (kW)		18,000 (5.3)		24,000 (7.0)	
Heating capacity ★2, ★4	Btu/h (kW)		20,000 (5.9)		27,000 (7.9)	
Heating capacity ★3, ★4	Btu/h (kW)		13,800 (4.0)		20,000 (5.9)	
EER2 (rated)	Btu/h-W		11.9		10.2	
SEER2 (rated)			16.9		17.3	
HSPF2 (rated)			7.6		7.8	
Indoor unit			FAQ18TAVJU		FAQ24TAVJU	
Casing/color			White (3.0Y8.5/0.5)		White (3.0Y8.5/0.5)	
Dimensions	H × W × D	in. (mm)	11-3/8 × 41-3/8 × 9-1/4 (290 × 1,050 × 238)		11-3/8 × 41-3/8 × 9-1/4 (290 × 1,050 × 238)	
Coil	Type		Cross fin coil		Cross fin coil	
Fan	Type		Cross flow fan		Cross flow fan	
	Motor output	W	43		43	
	Airflow rate (H / L)	cfm (m ³ /min)	500 / 400 (14 / 11)		635 / 470 (18 / 13)	
	External static pressure	in.H ₂ O (Pa)	—		—	
Air filter			Resin net (washable)		Resin net (washable)	
Weight	lbs (kg)		31 (14)		31 (14)	
Piping connections	Liquid	in. (mm)	φ3/8 (φ9.5) (flare connection)		φ3/8 (φ9.5) (flare connection)	
	Gas	in. (mm)	φ5/8 (φ15.9) (flare connection)		φ5/8 (φ15.9) (flare connection)	
	Drain	in. (mm)	VP13 (external dia. 11/16 (18), internal dia. 1/2 (13))		VP13 (external dia. 11/16 (18), internal dia. 1/2 (13))	
Remote controller (accessory)	Wired		BRC1E73 / BRC1H71W / DTST-ONE-ADA-A		BRC1E73 / BRC1H71W / DTST-ONE-ADA-A	
	Wireless		BRC7E818		BRC7E818	
Outdoor unit			RZQ18TBVJUA		RZQ24TBVJUA	
Casing/color			Ivory white		Ivory white	
Dimensions	H × W × D	in. (mm)	39 × 37 × 12-5/8 (990 × 940 × 320)		39 × 37 × 12-5/8 (990 × 940 × 320)	
Coil	Type		Cross fin coil		Cross fin coil	
Compressor	Type		Hermetically sealed swing type		Hermetically sealed swing type	
	Motor output	kW	1.9		1.9	
Fan	Type		Propeller fan		Propeller fan	
	Motor output	W	200		200	
	Airflow rate	cfm (m ³ /min)	2,682 (76)		2,682 (76)	
Weight	lbs (kg)		172 (78)		172 (78)	
Piping connections	Liquid	in. (mm)	φ3/8 (φ9.5) (flare connection)		φ3/8 (φ9.5) (flare connection)	
	Gas	in. (mm)	φ5/8 (φ15.9) (flare connection)		φ5/8 (φ15.9) (flare connection)	
	Drain	in. (mm)	φ1 (φ26) (hole)		φ1 (φ26) (hole)	
Safety devices			High pressure switch, Outdoor fan driver overload protector, Inverter overload protector, Fusible plug, Fuse		High pressure switch, Outdoor fan driver overload protector, Inverter overload protector, Fusible plug, Fuse	
Capacity step	%		14-100		14-100	
Refrigerant control			Electronic expansion valve		Electronic expansion valve	
Ref. piping	Standard length	ft (m)	25 (7.6)		25 (7.6)	
	Max. length	ft (m)	164 (50)		164 (50)	
	Max. height difference	ft (m)	98 (30)		98 (30)	
Refrigerant	Type		R410A		R410A	
	Charge	lbs (kg)	6.4 (2.9)		6.4 (2.9)	
Ref. oil	Type		DAPHNE FVC50K		DAPHNE FVC50K	
	Charge	L	1.08		1.08	

Note:

- ★1. Indoor temp.: 80°FDB (26.7°CDB), 67°FWB (19.4°CWB) / Outdoor temp.: 95°FDB (35.0°CDB) / Equivalent piping length: 25 ft. (7.6 m), height difference: 0 ft. (0 m).
- ★2. Indoor temp.: 70°FDB (21.1°CDB) / Outdoor temp.: 47°FDB (8.3°CDB), 43°FWB (6.1°CWB) / Equivalent piping length: 25 ft. (7.6 m), height difference: 0 ft. (0 m).
- ★3. Indoor temp.: 70°FDB (21.1°CDB) / Outdoor temp.: 17°FDB (-8.3°CDB), 15°FWB (-9.4°CWB) / Equivalent piping length: 25 ft. (7.6 m), height difference: 0 ft. (0 m).
- ★4. Capacities are net, including a deduction for cooling (an addition for heating) for indoor fan motor heat.

C: 4D143005A

4.2.3 FBQ

HSP concealed ducted unit

Model	Indoor unit		FBQ18TBVJU	FBQ24TBVJU
	Outdoor unit		RZQ18TBVJUA	RZQ24TBVJUA
Power supply			1 phase, 208/230 V, 60 Hz	1 phase, 208/230 V, 60 Hz
Cooling capacity ★1, ★4	Btu/h (kW)		17,700 (5.2)	23,400 (6.9)
Heating capacity ★2, ★4	Btu/h (kW)		20,600 (6.0)	27,400 (8.0)
Heating capacity ★3, ★4	Btu/h (kW)		14,000 (4.1)	19,000 (5.6)
EER2 (rated)	Btu/h-W		12.5	10.5
SEER2 (rated)			15.5	15.4
HSPF2 (rated)			8.5	9.3
Indoor unit			FBQ18TBVJU	FBQ24TBVJU
Casing/color			Galvanized steel plate	Galvanized steel plate
Dimensions	H × W × D	in. (mm)	9-11/16 × 39-3/8 × 31-1/2 (245 × 1,000 × 800)	9-11/16 × 39-3/8 × 31-1/2 (245 × 1,000 × 800)
Coil	Type		Cross fin coil	Cross fin coil
Fan	Type		Sirocco fan	Sirocco fan
	Motor output	W	230	230
	Airflow rate (H / M / L)	cfm (m ³ /min)	635 / 565 / 512 (18.0 / 16.0 / 14.5)	742 / 635 / 565 (21.0 / 18.0 / 16.0)
	External static pressure	in.H ₂ O (Pa)	Standard 0.40 <0.80-0.20> (100 <200-50>) ★5	Standard 0.40 <0.80-0.20> (100 <200-50>) ★5
Air filter			— ★6	— ★6
Weight		lbs (kg)	77 (35)	82(37)
Piping connections	Liquid	in. (mm)	φ3/8 (φ9.5) (flare connection)	φ3/8 (φ9.5) (flare connection)
	Gas	in. (mm)	φ5/8 (φ15.9) (flare connection)	φ5/8 (φ15.9) (flare connection)
	Drain	in. (mm)	VP25 (external dia. 1-1/4 (32), internal dia. 1 (26))	VP25 (external dia. 1-1/4 (32), internal dia. 1 (26))
Remote controller (accessory)	Wired		BRC1E73 / BRC1H71W / DTST-ONE-ADA-A	BRC1E73 / BRC1H71W / DTST-ONE-ADA-A
	Wireless		BRC082A43	BRC082A43
Outdoor unit			RZQ18TBVJUA	RZQ24TBVJUA
Casing/color			Ivory white	Ivory white
Dimensions	H × W × D	in. (mm)	39 × 37 × 12-5/8 (990 × 940 × 320)	39 × 37 × 12-5/8 (990 × 940 × 320)
Coil	Type		Cross fin coil	Cross fin coil
Compressor	Type		Hermetically sealed swing type	Hermetically sealed swing type
	Motor output	kW	1.9	1.9
Fan	Type		Propeller fan	Propeller fan
	Motor output	W	200	200
	Airflow rate	cfm (m ³ /min)	2,682 (76)	2,682 (76)
Weight		lbs (kg)	172 (78)	172 (78)
Piping connections	Liquid	in. (mm)	φ3/8 (φ9.5) (flare connection)	φ3/8 (φ9.5) (flare connection)
	Gas	in. (mm)	φ5/8 (φ15.9) (flare connection)	φ5/8 (φ15.9) (flare connection)
	Drain	in. (mm)	φ1 (φ26) (hole)	φ1 (φ26) (hole)
Safety devices			High pressure switch, Outdoor fan driver overload protector, Inverter overload protector, Fusible plug, Fuse	High pressure switch, Outdoor fan driver overload protector, Inverter overload protector, Fusible plug, Fuse
Capacity step		%	14-100	14-100
Refrigerant control			Electronic expansion valve	Electronic expansion valve
Ref. piping	Standard length	ft (m)	25 (7.6)	25 (7.6)
	Max. length	ft (m)	164 (50)	164 (50)
	Max. height difference	ft (m)	98 (30)	98 (30)
Refrigerant	Type		R410A	R410A
	Charge	lbs (kg)	6.4 (2.9)	6.4 (2.9)
Ref. oil	Type		DAPHNE FVC50K	DAPHNE FVC50K
	Charge	L	1.08	1.08

Note:

- ★1. Indoor temp.: 80°FDB (26.7°CDB), 67°FWB (19.4°CWB) / Outdoor temp.: 95°FDB (35.0°CDB) / Equivalent piping length: 25 ft. (7.6 m), height difference: 0 ft. (0 m).
- ★2. Indoor temp.: 70°FDB (21.1°CDB) / Outdoor temp.: 47°FDB (8.3°CDB), 43°FWB (6.1°CWB) / Equivalent piping length: 25 ft. (7.6 m), height difference: 0 ft. (0 m).
- ★3. Indoor temp.: 70°FDB (21.1°CDB) / Outdoor temp.: 17°FDB (-8.3°CDB), 15°FWB (-9.4°CWB) / Equivalent piping length: 25 ft. (7.6 m), height difference: 0 ft. (0 m).
- ★4. Capacities are net, including a deduction for cooling (an addition for heating) for indoor fan motor heat.
- ★5. External static pressure is changeable in 14 stages within the < > range by remote controller.
- ★6. Air filter is not standard accessory, but please mount it in the duct system of the suction side.
Select its dust collection efficiency (gravity method) 50% or more.

C: 4D143007A

HSP concealed ducted unit, continued

Model	Indoor unit		FBQ30TBVJU		FBQ36TBVJU	
	Outdoor unit		RZQ30TBVJUA		RZQ36TBVJUA	
Power supply			1 phase, 208/230 V, 60 Hz		1 phase, 208/230 V, 60 Hz	
Cooling capacity ★1, ★4	Btu/h (kW)		28,400 (8.3)		35,000 (10.3)	
Heating capacity ★2, ★4	Btu/h (kW)		34,800 (10.2)		40,000 (11.7)	
Heating capacity ★3, ★4	Btu/h (kW)		24,000 (7.0)		28,000 (8.2)	
EER2 (rated)	Btu/h-W		12.2		11.7	
SEER2 (rated)			16.5		16.9	
HSPF2 (rated)			8.9		8.8	
Indoor unit			FBQ30TBVJU		FBQ36TBVJU	
Casing/color			Galvanized steel plate		Galvanized steel plate	
Dimensions	H × W × D	in. (mm)	9-11/16 × 55-1/8 × 31-1/2 (245 × 1,400 × 800)		9-11/16 × 55-1/8 × 31-1/2 (245 × 1,400 × 800)	
Coil	Type		Cross fin coil		Cross fin coil	
Fan	Type		Sirocco fan		Sirocco fan	
	Motor output	W	364		364	
	Airflow rate (H / M / L)	cfm (m³/min)	1,094 / 847 / 795 (31.0 / 24.0 / 22.5)		1,130 / 953 / 795 (32.0 / 27.0 / 22.5)	
	External static pressure	in.H ₂ O (Pa)	Standard 0.40 <0.80-0.20> (100 <200-50>) ★5		Standard 0.40 <0.80-0.20> (100 <200-50>) ★5	
Air filter			— ★6		— ★6	
Weight		lbs (kg)	101 (46)		101 (46)	
Piping connections	Liquid	in. (mm)	ϕ3/8 (ϕ9.5) (flare connection)		ϕ3/8 (ϕ9.5) (flare connection)	
	Gas	in. (mm)	ϕ5/8 (ϕ15.9) (flare connection)		ϕ5/8 (ϕ15.9) (flare connection)	
	Drain	in. (mm)	VP25 (external dia. 1-1/4 (32), internal dia. 1 (26))		VP25 (external dia. 1-1/4 (32), internal dia. 1 (26))	
Remote controller (accessory)	Wired		BRC1E73 / BRC1H71W / DTST-ONE-ADA-A		BRC1E73 / BRC1H71W / DTST-ONE-ADA-A	
	Wireless		BRC082A43		BRC082A43	
Outdoor unit			RZQ30TBVJUA		RZQ36TBVJUA	
Casing/color			Ivory white		Ivory white	
Dimensions	H × W × D	in. (mm)	52-15/16 × 35-7/16 × 12-5/8 (1,345 × 900 × 320)		52-15/16 × 35-7/16 × 12-5/8 (1,345 × 900 × 320)	
Coil	Type		Cross fin coil		Cross fin coil	
Compressor	Type		Hermetically sealed swing type		Hermetically sealed swing type	
	Motor output	kW	3.5		3.5	
Fan	Type		Propeller fan		Propeller fan	
	Motor output	W	70 × 2		70 × 2	
	Airflow rate	cfm (m³/min)	3,741 (106)		3,741 (106)	
Weight		lbs (kg)	225 (102)		225 (102)	
Piping connections	Liquid	in. (mm)	ϕ3/8 (ϕ9.5) (flare connection)		ϕ3/8 (ϕ9.5) (flare connection)	
	Gas	in. (mm)	ϕ5/8 (ϕ15.9) (flare connection)		ϕ5/8 (ϕ15.9) (flare connection)	
	Drain	in. (mm)	ϕ1 (ϕ26) (hole)		ϕ1 (ϕ26) (hole)	
Safety devices			High pressure switch, Outdoor fan driver overload protector, Inverter overload protector, Fusible plug, Fuse		High pressure switch, Outdoor fan driver overload protector, Inverter overload protector, Fusible plug, Fuse	
Capacity step		%	14-100		14-100	
Refrigerant control			Electronic expansion valve		Electronic expansion valve	
Ref. piping	Standard length	ft (m)	25 (7.6)		25 (7.6)	
	Max. length	ft (m)	230 (70)		230 (70)	
	Max. height difference	ft (m)	98 (30)		98 (30)	
Refrigerant	Type		R410A		R410A	
	Charge	lbs (kg)	7.9 (3.6)		7.9 (3.6)	
Ref. oil	Type		DAPHNE FVC50K		DAPHNE FVC50K	
	Charge	L	1.52		1.52	

Note:

- ★1. Indoor temp.: 80°FDB (26.7°CDB), 67°FWB (19.4°CWB) / Outdoor temp.: 95°FDB (35.0°CDB) / Equivalent piping length: 25 ft. (7.6 m), height difference: 0 ft. (0 m).
- ★2. Indoor temp.: 70°FDB (21.1°CDB) / Outdoor temp.: 47°FDB (8.3°CDB), 43°FWB (6.1°CWB) / Equivalent piping length: 25 ft. (7.6 m), height difference: 0 ft. (0 m).
- ★3. Indoor temp.: 70°FDB (21.1°CDB) / Outdoor temp.: 17°FDB (-8.3°CDB), 15°FWB (-9.4°CWB) / Equivalent piping length: 25 ft. (7.6 m), height difference: 0 ft. (0 m).
- ★4. Capacities are net, including a deduction for cooling (an addition for heating) for indoor fan motor heat.
- ★5. External static pressure is changeable in 14 stages within the < > range by remote controller.
- ★6. Air filter is not standard accessory, but please mount it in the duct system of the suction side.
Select its dust collection efficiency (gravity method) 50% or more.

C: 4D143008A

HSP concealed ducted unit, continued

Model	Indoor unit		FBQ42TBVJU	FBQ48TBVJU
	Outdoor unit		RZQ42TBVJUA	RZQ48TBVJUA
Power supply			1 phase, 208/230 V, 60 Hz	1 phase, 208/230 V, 60 Hz
Cooling capacity ★1, ★4	Btu/h (kW)		40,000 (11.7)	46,500 (13.6)
Heating capacity ★2, ★4	Btu/h (kW)		47,000 (13.8)	54,000 (15.8)
Heating capacity ★3, ★4	Btu/h (kW)		32,400 (9.5)	38,000 (11.1)
EER2 (rated)	Btu/h-W		10.3	8.3
SEER2 (rated)			15.6	15.3
HSPF2 (rated)			9.5	9.3
Indoor unit			FBQ42TBVJU	FBQ48TBVJU
Casing/color			Galvanized steel plate	Galvanized steel plate
Dimensions	H × W × D	in. (mm)	9-11/16 × 55-1/8 × 31-1/2 (245 × 1,400 × 800)	9-11/16 × 55-1/8 × 31-1/2 (245 × 1,400 × 800)
Coil	Type		Cross fin coil	Cross fin coil
Fan	Type		Sirocco fan	Sirocco fan
	Motor output	W	364	364
	Airflow rate (H / M / L)	cfm (m ³ /min)	1,377 / 1,130 / 918 (39.0 / 32.0 / 26.0)	1,377 / 1,130 / 918 (39.0 / 32.0 / 26.0)
	External static pressure	in.H ₂ O (Pa)	Standard 0.40 <0.80-0.20> (100 <200-50>) ★5	Standard 0.40 <0.80-0.20> (100 <200-50>) ★5
Air filter			— ★6	— ★6
Weight		lbs (kg)	104 (47)	104 (47)
Piping connections	Liquid	in. (mm)	φ3/8 (φ9.5) (flare connection)	φ3/8 (φ9.5) (flare connection)
	Gas	in. (mm)	φ5/8 (φ15.9) (flare connection)	φ5/8 (φ15.9) (flare connection)
	Drain	in. (mm)	VP25 (external dia. 1-1/4 (32), internal dia. 1 (26))	VP25 (external dia. 1-1/4 (32), internal dia. 1 (26))
Remote controller (accessory)	Wired		BRC1E73 / BRC1H71W / DTST-ONE-ADA-A	BRC1E73 / BRC1H71W / DTST-ONE-ADA-A
	Wireless		BRC082A43	BRC082A43
Outdoor unit			RZQ42TBVJUA	RZQ48TBVJUA
Casing/color			Ivory white	Ivory white
Dimensions	H × W × D	in. (mm)	52-15/16 × 35-7/16 × 12-5/8 (1,345 × 900 × 320)	52-15/16 × 35-7/16 × 12-5/8 (1,345 × 900 × 320)
Coil	Type		Cross fin coil	Cross fin coil
Compressor	Type		Hermetically sealed swing type	Hermetically sealed swing type
	Motor output	kW	3.5	3.5
Fan	Type		Propeller fan	Propeller fan
	Motor output	W	70 × 2	70 × 2
	Airflow rate	cfm (m ³ /min)	3,741 (106)	3,741 (106)
Weight		lbs (kg)	225 (102)	225 (102)
Piping connections	Liquid	in. (mm)	φ3/8 (φ9.5) (flare connection)	φ3/8 (φ9.5) (flare connection)
	Gas	in. (mm)	φ5/8 (φ15.9) (flare connection)	φ5/8 (φ15.9) (flare connection)
	Drain	in. (mm)	φ1 (φ26) (hole)	φ1 (φ26) (hole)
Safety devices			High pressure switch, Outdoor fan driver overload protector, Inverter overload protector, Fusible plug, Fuse	High pressure switch, Outdoor fan driver overload protector, Inverter overload protector, Fusible plug, Fuse
Capacity step		%	14-100	14-100
Refrigerant control			Electronic expansion valve	Electronic expansion valve
Ref. piping	Standard length	ft (m)	25 (7.6)	25 (7.6)
	Max. length	ft (m)	230 (70)	230 (70)
	Max. height difference	ft (m)	98 (30)	98 (30)
Refrigerant	Type		R410A	R410A
	Charge	lbs (kg)	7.9 (3.6)	7.9 (3.6)
Ref. oil	Type		DAPHNE FVC50K	DAPHNE FVC50K
	Charge	L	1.52	1.52

Note:

- ★1. Indoor temp.: 80°FDB (26.7°CDB), 67°FWB (19.4°CWB) / Outdoor temp.: 95°FDB (35.0°CDB) / Equivalent piping length: 25 ft. (7.6 m), height difference: 0 ft. (0 m).
- ★2. Indoor temp.: 70°FDB (21.1°CDB) / Outdoor temp.: 47°FDB (8.3°CDB), 43°FWB (6.1°CWB) / Equivalent piping length: 25 ft. (7.6 m), height difference: 0 ft. (0 m).
- ★3. Indoor temp.: 70°FDB (21.1°CDB) / Outdoor temp.: 17°FDB (-8.3°CDB), 15°FWB (-9.4°CWB) / Equivalent piping length: 25 ft. (7.6 m), height difference: 0 ft. (0 m).
- ★4. Capacities are net, including a deduction for cooling (an addition for heating) for indoor fan motor heat.
- ★5. External static pressure is changeable in 14 stages within the < > range by remote controller.
- ★6. Air filter is not standard accessory, but please mount it in the duct system of the suction side.
Select its dust collection efficiency (gravity method) 50% or more.

C: 4D143008A

4.2.4 FTQ

Air handling unit

Model	Indoor unit	with factory disconnect		FTQ18TAVJUD	FTQ24TAVJUD
		without factory disconnect		FTQ18TAVJUA	FTQ24TAVJUA
Outdoor unit				RZQ18TBVJUA	RZQ24TBVJUA
Power supply				1 phase, 208/230 V, 60 Hz	1 phase, 208/230 V, 60 Hz
Cooling capacity ★1, ★4		Btu/h (kW)		17,200 (5.0)	23,400 (6.9)
Heating capacity ★2, ★4		Btu/h (kW)		20,000 (5.9)	27,400 (8.0)
Heating capacity ★3, ★4		Btu/h (kW)		13,600 (4.0)	19,400 (5.7)
EER2 (rated)		Btu/h-W		11.7	9.9
SEER2 (rated)				15.6	16.2
HSPF2 (rated)				8.1	8.7
Indoor unit		with factory disconnect		FTQ18TAVJUD	FTQ24TAVJUD
		without factory disconnect		FTQ18TAVJUA	FTQ24TAVJUA
Casing/color				Daikin Slate Gray	Daikin Slate Gray
Dimensions	H × W × D	in. (mm)		45 × 17.5 × 21 (1,143 × 445 × 533)	45 × 17.5 × 21 (1,143 × 445 × 533)
Coil	Type			Cross fin coil	Cross fin coil
	Type			Sirocco FC Centrifugal	Sirocco FC Centrifugal
Fan	Motor output	HP		1/2	1/2
	Airflow rate (H / M / L)	cfm (m ³ /min)		600 / 510 / 420 (17.0 / 14.4 / 11.9)	800 / 680 / 560 (22.7 / 19.3 / 15.9)
	External static pressure	in. w.g.		0.1" - 0.9"	0.1" - 0.9"
Air filter				— ★5	— ★5
Weight		lbs (kg)		115 (52.2)	115 (52.2)
Piping connections	Liquid	in. (mm)		φ3/8 (φ9.5) (brazing connection)	φ3/8 (φ9.5) (brazing connection)
	Gas	in. (mm)		φ5/8 (φ15.9) (brazing connection)	φ5/8 (φ15.9) (brazing connection)
	Drain	in. (mm)		3/4" (19.1)	3/4" (19.1)
Remote controller (accessory)	Wired			BRC1E73 / BRC1H71W / DTST-ONE-ADA-A	BRC1E73 / BRC1H71W / DTST-ONE-ADA-A
	Wireless			BRC4C82	BRC4C82
Outdoor unit				RZQ18TBVJUA	RZQ24TBVJUA
Casing/color				Ivory white	Ivory white
Dimensions	H × W × D	in. (mm)		39 × 37 × 12-5/8 (990 × 940 × 320)	39 × 37 × 12-5/8 (990 × 940 × 320)
Coil	Type			Cross fin coil	Cross fin coil
	Type			Hermetically sealed swing type	Hermetically sealed swing type
Compressor	Motor output	kW		1.9	1.9
	Type			Propeller fan	Propeller fan
Fan	Motor output	W		200	200
	Airflow rate	cfm (m ³ /min)		2,682 (76)	2,682 (76)
Weight		lbs (kg)		172 (78)	172 (78)
Piping connections	Liquid	in. (mm)		φ3/8 (φ9.5) (flare connection)	φ3/8 (φ9.5) (flare connection)
	Gas	in. (mm)		φ5/8 (φ15.9) (flare connection)	φ5/8 (φ15.9) (flare connection)
	Drain	in. (mm)		φ1 (φ26) (hole)	φ1 (φ26) (hole)
Safety devices				High pressure switch, Outdoor fan driver overload protector, Inverter overload protector, Fusible plug, Fuse	High pressure switch, Outdoor fan driver overload protector, Inverter overload protector, Fusible plug, Fuse
Capacity step		%		14-100	14-100
Refrigerant control				Electronic expansion valve	Electronic expansion valve
Ref. piping	Standard length	ft (m)		25 (7.6)	25 (7.6)
	Max. length	ft (m)		164 (50)	164 (50)
	Max. height difference	ft (m)		98 (30)	98 (30)
Refrigerant	Type			R410A	R410A
	Charge	lbs (kg)		6.4 (2.9)	6.4 (2.9)
Ref. oil	Type			DAPHNE FVC50K	DAPHNE FVC50K
	Charge	L		1.08	1.08

Note:

- ★1. Indoor temp.: 80°FDB (26.7°CDB), 67°FWB (19.4°CWB) / Outdoor temp.: 95°FDB (35.0°CDB) / Equivalent piping length: 25 ft. (7.6 m), height difference: 0 ft. (0 m).
- ★2. Indoor temp.: 70°FDB (21.1°CDB) / Outdoor temp.: 47°FDB (8.3°CDB), 43°FWB (6.1°CWB) / Equivalent piping length: 25 ft. (7.6 m), height difference: 0 ft. (0 m).
- ★3. Indoor temp.: 70°FDB (21.1°CDB) / Outdoor temp.: 17°FDB (-8.3°CDB), 15°FWB (-9.4°CWB) / Equivalent piping length: 25 ft. (7.6 m), height difference: 0 ft. (0 m).
- ★4. Capacities are net, including a deduction for cooling (an addition for heating) for indoor fan motor heat.
- ★5. Air filter is not standard accessory (field supply parts), but please mount it in the duct system of the suction side.

Air handling unit, continued

Model	Indoor unit	with factory disconnect		FTQ30TAVJUD	FTQ36TAVJUD
		without factory disconnect		FTQ30TAVJUA	FTQ36TAVJUA
Outdoor unit				RZQ30TBVJUA	RZQ36TBVJUA
Power supply				1 phase, 208/230 V, 60 Hz	1 phase, 208/230 V, 60 Hz
Cooling capacity ★1, ★4		Btu/h (kW)		29,500 (8.6)	35,000 (10.3)
Heating capacity ★2, ★4		Btu/h (kW)		34,000 (10.0)	40,000 (11.7)
Heating capacity ★3, ★4		Btu/h (kW)		24,000 (7.0)	28,500 (8.4)
EER2 (rated)		Btu/h-W		11.9	11.2
SEER2 (rated)				15.6	16.4
HSPF2 (rated)				9.1	8.8
Indoor unit		with factory disconnect		FTQ30TAVJUD	FTQ36TAVJUD
		without factory disconnect		FTQ30TAVJUA	FTQ36TAVJUA
Casing/color				Daikin Slate Gray	Daikin Slate Gray
Dimensions	H × W × D	in. (mm)		45 × 17.5 × 21 (1,143 × 445 × 533)	45 × 17.5 × 21 (1,143 × 445 × 533)
Coil	Type		Cross fin coil		Cross fin coil
	Type		Sirocco FC Centrifugal		Sirocco FC Centrifugal
Fan	Motor output	HP		1/2	1/2
	Airflow rate (H / M / L)	cfm (m ³ /min)		1,000 / 850 / 700 (28.3 / 24.1 / 19.8)	1,050 / 900 / 750 (29.7 / 25.5 / 21.2)
	External static pressure	in. w.g.		0.1" - 0.9"	0.1" - 0.9"
Air filter				— ★5	— ★5
Weight		lbs (kg)		115 (52.2)	140 (63.5)
Piping connections	Liquid	in. (mm)		φ3/8 (φ9.5) (brazing connection)	φ3/8 (φ9.5) (brazing connection)
	Gas	in. (mm)		φ5/8 (φ15.9) (brazing connection)	φ5/8 (φ15.9) (brazing connection)
	Drain	in. (mm)		3/4" (19.1)	3/4" (19.1)
Remote controller (accessory)	Wired		BRC1E73 / BRC1H71W / DTST-ONE-ADA-A		BRC1E73 / BRC1H71W / DTST-ONE-ADA-A
	Wireless		BRC4C82		BRC4C82
Outdoor unit				RZQ30TBVJUA	RZQ36TBVJUA
Casing/color				Ivory white	Ivory white
Dimensions	H × W × D	in. (mm)		52-15/16 × 35-7/16 × 12-5/8 (1,345 × 900 × 320)	52-15/16 × 35-7/16 × 12-5/8 (1,345 × 900 × 320)
Coil	Type		Cross fin coil		Cross fin coil
	Type		Hermetically sealed swing type		Hermetically sealed swing type
Compressor	Motor output	kW		3.5	3.5
	Type		Propeller fan		Propeller fan
Fan	Motor output	W		70 × 2	70 × 2
	Airflow rate	cfm (m ³ /min)		3,741 (106)	3,741 (106)
	Weight		lbs (kg)		225 (102)
Piping connections	Liquid	in. (mm)		φ3/8 (φ9.5) (flare connection)	φ3/8 (φ9.5) (flare connection)
	Gas	in. (mm)		φ5/8 (φ15.9) (flare connection)	φ5/8 (φ15.9) (flare connection)
	Drain	in. (mm)		φ1 (φ26) (hole)	φ1 (φ26) (hole)
Safety devices				High pressure switch, Outdoor fan driver overload protector, Inverter overload protector, Fusible plug, Fuse	High pressure switch, Outdoor fan driver overload protector, Inverter overload protector, Fusible plug, Fuse
Capacity step		%		14-100	14-100
Refrigerant control				Electronic expansion valve	Electronic expansion valve
Ref. piping	Standard length	ft (m)		25 (7.6)	25 (7.6)
	Max. length	ft (m)		230 (70)	230 (70)
	Max. height difference	ft (m)		98 (30)	98 (30)
Refrigerant	Type		R410A		R410A
	Charge	lbs (kg)		7.9 (3.6)	7.9 (3.6)
Ref. oil	Type		DAPHNE FVC50K		DAPHNE FVC50K
	Charge	L		1.52	1.52

Note:

- ★1. Indoor temp.: 80°FDB (26.7°CDB), 67°FWB (19.4°CWB) / Outdoor temp.: 95°FDB (35.0°CDB) / Equivalent piping length: 25 ft. (7.6 m), height difference: 0 ft. (0 m).
- ★2. Indoor temp.: 70°FDB (21.1°CDB) / Outdoor temp.: 47°FDB (8.3°CDB), 43°FWB (6.1°CWB) / Equivalent piping length: 25 ft. (7.6 m), height difference: 0 ft. (0 m).
- ★3. Indoor temp.: 70°FDB (21.1°CDB) / Outdoor temp.: 17°FDB (-8.3°CDB), 15°FWB (-9.4°CWB) / Equivalent piping length: 25 ft. (7.6 m), height difference: 0 ft. (0 m).
- ★4. Capacities are net, including a deduction for cooling (an addition for heating) for indoor fan motor heat.
- ★5. Air filter is not standard accessory (field supply parts), but please mount it in the duct system of the suction side.

Air handling unit, continued

Model	Indoor unit	with factory disconnect		FTQ42TAVJUD	FTQ48TAVJUD
		without factory disconnect		FTQ42TAVJUA	FTQ48TAVJUA
Outdoor unit				RZQ42TBVJUA	RZQ48TBVJUA
Power supply				1 phase, 208/230 V, 60 Hz	1 phase, 208/230 V, 60 Hz
Cooling capacity ★1, ★4		Btu/h (kW)		40,500 (11.9)	47,000 (13.8)
Heating capacity ★2, ★4		Btu/h (kW)		47,000 (13.8)	54,000 (15.8)
Heating capacity ★3, ★4		Btu/h (kW)		33,000 (9.7)	36,800 (10.8)
EER2 (rated)		Btu/h-W		10.6	9.1
SEER2 (rated)				16.0	15.3
HSPF2 (rated)				9.2	8.8
Indoor unit		with factory disconnect		FTQ42TAVJUD	FTQ48TAVJUD
		without factory disconnect		FTQ42TAVJUA	FTQ48TAVJUA
Casing/color				Daikin Slate Gray	Daikin Slate Gray
Dimensions	H × W × D	in. (mm)		53.43 × 21 × 21 (1,357 × 533 × 533)	53.43 × 21 × 21 (1,357 × 533 × 533)
Coil	Type		Cross fin coil		Cross fin coil
Fan	Type		Sirocco FC Centrifugal		Sirocco FC Centrifugal
	Motor output	HP		3/4	3/4
	Airflow rate (H / M / L)	cfm (m ³ /min)		1,400 / 1,190 / 980 (39.7 / 33.7 / 27.8)	1,520 / 1,290 / 1,060 (43.1 / 36.5 / 30.0)
	External static pressure	in. w.g.		0.1" - 0.9"	0.1" - 0.9"
Air filter				— ★5	— ★5
Weight		lbs (kg)		150 (68)	150 (68)
Piping connections	Liquid	in. (mm)		ϕ3/8 (ϕ9.5) (brazing connection)	ϕ3/8 (ϕ9.5) (brazing connection)
	Gas	in. (mm)		ϕ5/8 (ϕ15.9) (brazing connection)	ϕ5/8 (ϕ15.9) (brazing connection)
	Drain	in. (mm)		3/4" (19.1)	3/4" (19.1)
Remote controller (accessory)	Wired		BRC1E73 / BRC1H71W / DTST-ONE-ADA-A		BRC1E73 / BRC1H71W / DTST-ONE-ADA-A
	Wireless		BRC4C82		BRC4C82
Outdoor unit				RZQ42TBVJUA	RZQ48TBVJUA
Casing/color				Ivory white	Ivory white
Dimensions	H × W × D	in. (mm)		52-15/16 × 35-7/16 × 12-5/8 (1,345 × 900 × 320)	52-15/16 × 35-7/16 × 12-5/8 (1,345 × 900 × 320)
Coil	Type		Cross fin coil		Cross fin coil
Compressor	Type		Hermetically sealed swing type		Hermetically sealed swing type
	Motor output	kW		3.5	3.5
Fan	Type		Propeller fan		Propeller fan
	Motor output	W		70 × 2	70 × 2
	Airflow rate	cfm (m ³ /min)		3,741 (106)	3,741 (106)
Weight		lbs (kg)		225 (102)	225 (102)
Piping connections	Liquid	in. (mm)		ϕ3/8 (ϕ9.5) (flare connection)	ϕ3/8 (ϕ9.5) (flare connection)
	Gas	in. (mm)		ϕ5/8 (ϕ15.9) (flare connection)	ϕ5/8 (ϕ15.9) (flare connection)
	Drain	in. (mm)		ϕ1 (ϕ26) (hole)	ϕ1 (ϕ26) (hole)
Safety devices				High pressure switch, Outdoor fan driver overload protector, Inverter overload protector, Fusible plug, Fuse	High pressure switch, Outdoor fan driver overload protector, Inverter overload protector, Fusible plug, Fuse
Capacity step		%		14-100	14-100
Refrigerant control				Electronic expansion valve	Electronic expansion valve
Ref. piping	Standard length	ft (m)		25 (7.6)	25 (7.6)
	Max. length	ft (m)		230 (70)	230 (70)
	Max. height difference	ft (m)		98 (30)	98 (30)
Refrigerant	Type		R410A		R410A
	Charge	lbs (kg)		7.9 (3.6)	7.9 (3.6)
Ref. oil	Type		DAPHNE FVC50K		DAPHNE FVC50K
	Charge	L		1.52	1.52

Note:

- ★1. Indoor temp.: 80°FDB (26.7°CDB), 67°FWB (19.4°CWB) / Outdoor temp.: 95°FDB (35.0°CDB) / Equivalent piping length: 25 ft. (7.6 m), height difference: 0 ft. (0 m).
- ★2. Indoor temp.: 70°FDB (21.1°CDB) / Outdoor temp.: 47°FDB (8.3°CDB), 43°FWB (6.1°CWB) / Equivalent piping length: 25 ft. (7.6 m), height difference: 0 ft. (0 m).
- ★3. Indoor temp.: 70°FDB (21.1°CDB) / Outdoor temp.: 17°FDB (-8.3°CDB), 15°FWB (-9.4°CWB) / Equivalent piping length: 25 ft. (7.6 m), height difference: 0 ft. (0 m).
- ★4. Capacities are net, including a deduction for cooling (an addition for heating) for indoor fan motor heat.
- ★5. Air filter is not standard accessory (field supply parts), but please mount it in the duct system of the suction side.

5. Dimensions

5.1 Indoor Unit

5.1.1 FCQ (with Standard Sensing Decoration Panel)

FCQ18 - 24AAVJU (with standard sensing decoration panel)

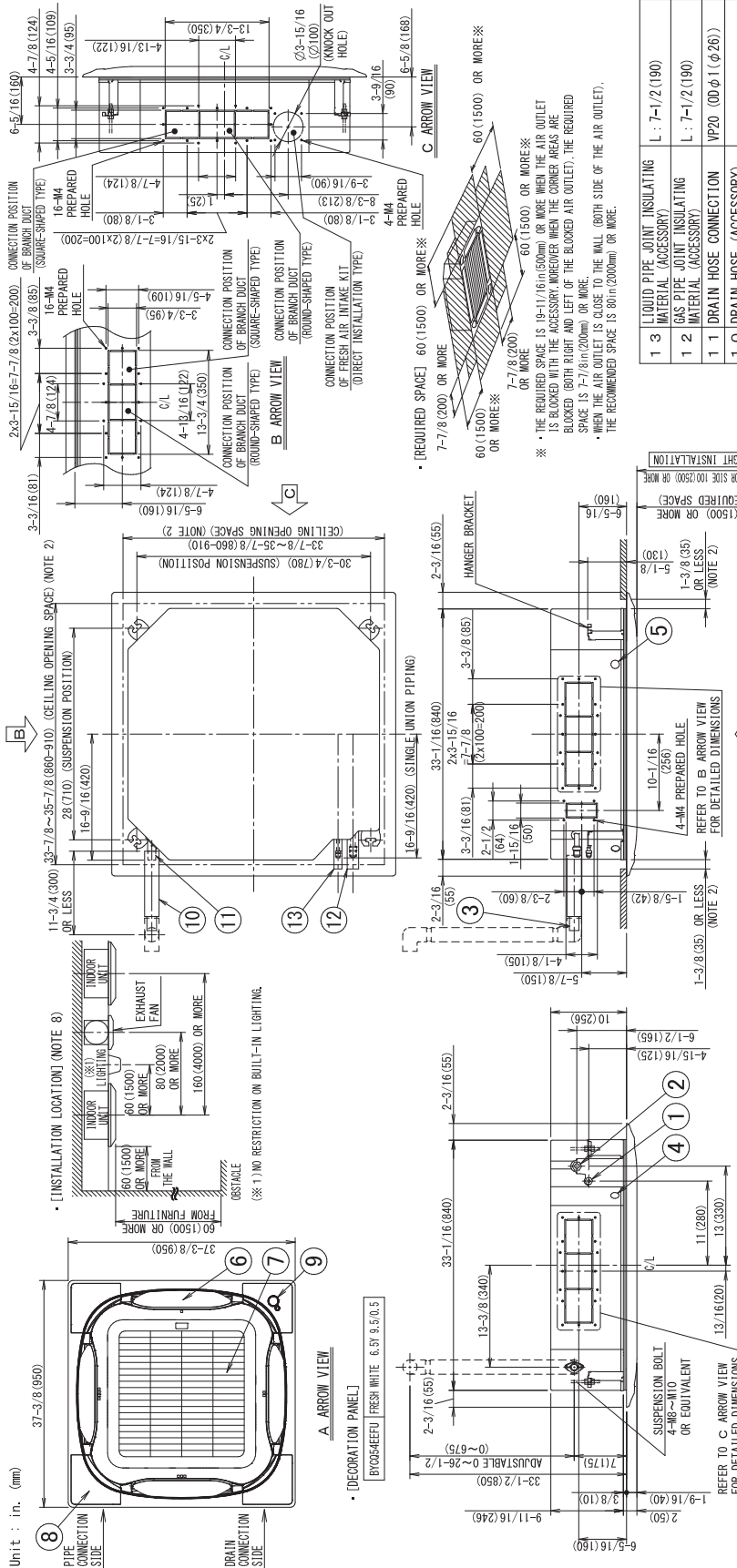

ITEM	PART NAME	REMARK
1 3	LIQUID PIPE JOINT INSULATING MATERIAL (ACCESSORY)	L : 7-1/2 (190)
1 2	GAS PIPE JOINT INSULATING MATERIAL (ACCESSORY)	L : 7-1/2 (190)
1 1	DRAIN HOSE CONNECTION	VP20 (OD φ 1 (φ 26))
1 0	DRAIN HOSE (ACCESSORY)	
9	SENSOR	INFRARED PRESENCE SENSOR INFRARED FLOOR SENSOR
8	CORNER COVER	
7	SUCTION GRILLE	
6	AIR OUTLET	
5	REMOTE CONTROLLER AND TRANSMISSION WIRING CONNECTION	
4	POWER SUPPLY WIRING CONNECTION	
3	DRAIN PIPE CONNECTION	VP25 (OD φ 1-1/4 (φ 32))
2	GAS PIPE CONNECTION (FLARE CONNECTION)	φ 5/8 (φ 15.9)
1	LIQUID PIPE CONNECTION (FLARE CONNECTION)	φ 3/8 (φ 9.5)

NOTE

- STOKING LOCATION FOR MANUFACTURER'S LABEL
- MANUFACTURER'S LABEL FOR DECORATION PANEL: INNER SURFACE OF CORNER COVER
- THOUGH INSTALLATION IS ACCEPTABLE UP TO 35-7/8 (910mm) SQUARE CEILING OPENING, KEEP THE CLEARANCE OF 1-3/8 (35mm) OR LESS BETWEEN THE INDOOR UNIT AND THE CEILING OPENING SO THAT THE PANEL OVERLAP ALLOWANCE CAN BE ENSURED.
- WHEN TEMPERATURE AND HUMIDITY IN THE CEILING EXCEEDS 86°F (30°C) AND RH 80%, OUTSIDE AIR IS INDICATED INTO THE CEILING OR THE UNIT CONTINUES 24 HOUR OPERATION. AN ADDITIONAL INSULATION (THICKNESS 2.8 in (70mm) OR MORE OF GLASSWOL OR POLYETHYLENE FOAM) IS REQUIRED.
- DO NOT PLACE ANYTHING SENSITIVE TO MOISTURE UNDER THE INDOOR UNIT. CONDENSATION MAY FORM WHEN HUMIDITY IS 80% OR MORE. THE AIR OUTLET IS CLOSED, OR THE AIR FILTER IS DIRTY.
- INSTALL IN ACCORDANCE WITH THE ABOVE FIGURE SINCE THE CEILING SURFACE MAY GET DIRTY IF THE DEVICES THAT DISTURB THE AIR FLOW SUCH AS VENTILATION OPENINGS AND LIGHTING EQUIPMENT ARE CLOSE BY.
- INSTALLATION LOCATIONS OF THE INFRARED PRESENCE SENSOR AND INFRARED FLOOR SENSOR ARE SHOWN IN THE ABOVE FIGURE. (LOCATION CHANGE IS NOT PERMITTED.)
- JOINT INSULATING MATERIAL ATTACHED TO THE UNIT IS FOR FIELD PIPING THAT IS INSULATED TO A THICKNESS OF 3/8 in (10mm) OR LESS. IF THE FIELD PIPING IS INSULATED TO A THICKNESS OF MORE THAN 3/8 in (10mm), INSTEAD OF USING JOINT INSULATING MATERIAL ATTACHED TO THE UNIT, USE INSULATING MATERIAL AND CLAMPS (BOTH FIELD SUPPLY) THAT ARE SUITABLE FOR THE FIELD PIPING, AND BE SURE TO CARRY OUT INSULATION ACCORDING TO THE PROCEDURE IN INSTALLATION MANUAL. IF NOT INSULATED, WATER LEAKAGE MAY BE CAUSED BY CONDENSATION.
- DEPENDENT ON ROOM AIRFLOW CONDITIONS (SUCH AS AIR STREAM BY FAN, CIRCULATOR OR OPENING DOOR) AND TEMPERATURE, HUMIDITY AND AIRFLOW CONDITIONS IN ATTIC/B OUTSIDE AIR INTAKE AND SO ON, CONDENSATION MAY OCCUR ON CEILING NEAR THE CORNER AIR OUTLET. IN THAT CASE, CLOSE THE CORNER AIR OUTLET USING THE SEALING MATERIAL KIT (SOLD SEPARATELY).

3D141046A

5.1.2 FCQ (with Self-Cleaning Filter Panel) FCQ18 - 24AAVJU (with self-cleaning filter panel)

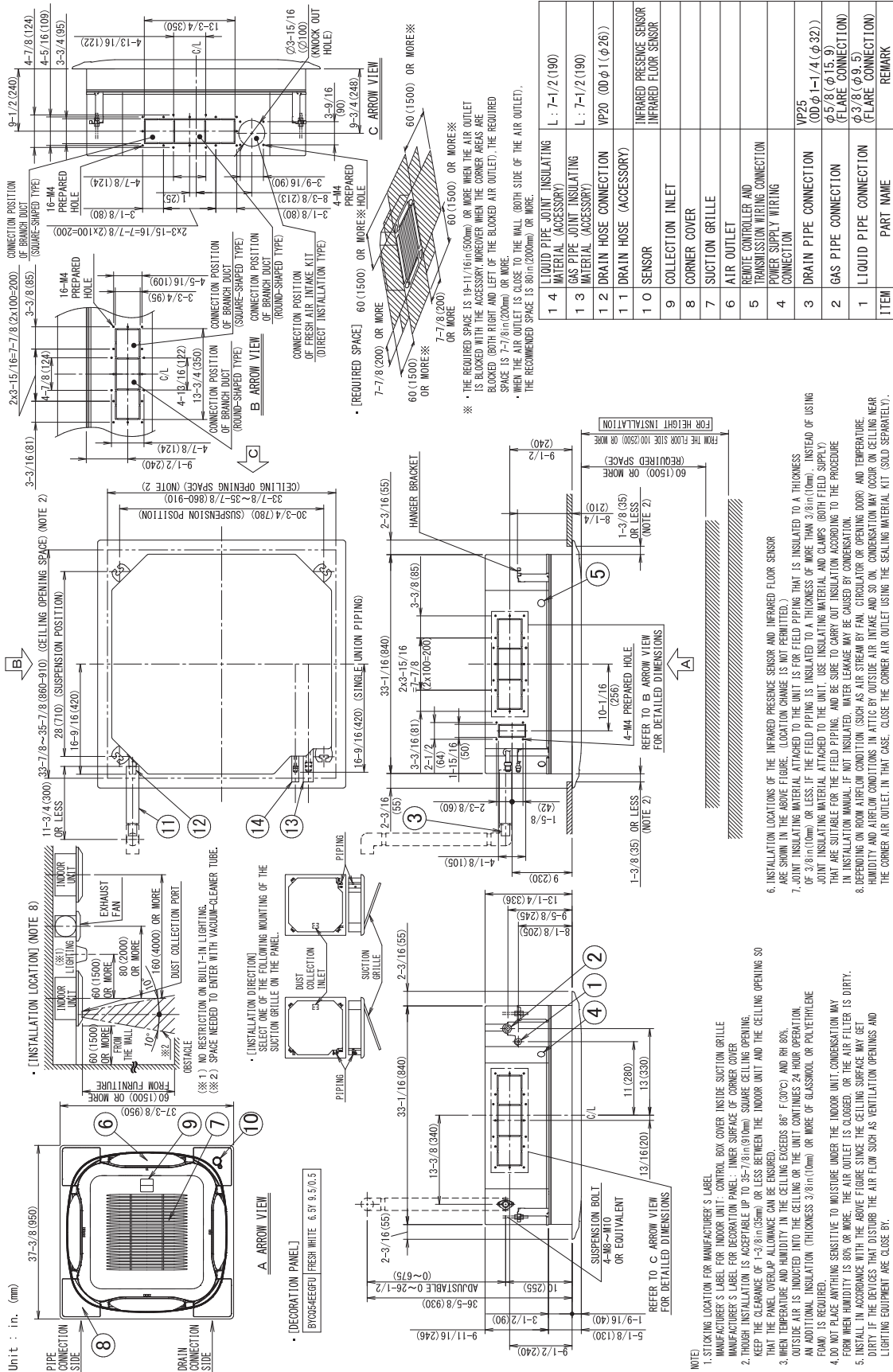

3D141049A

FCQ30 - 48AAVJU (with self-cleaning filter panel)

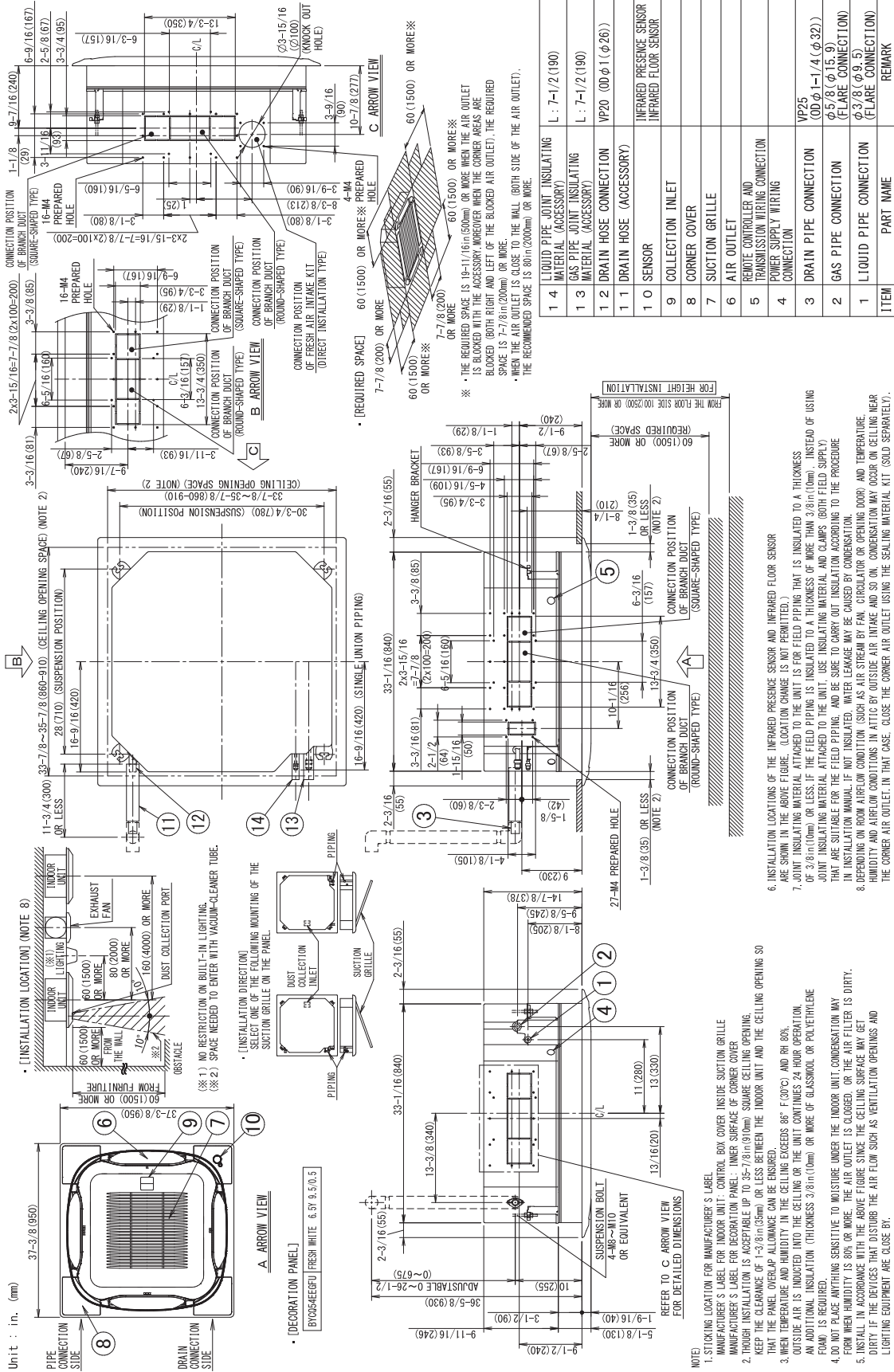

3D141050A

5.1.3 FAQ
FAQ18 - 24TAVJU

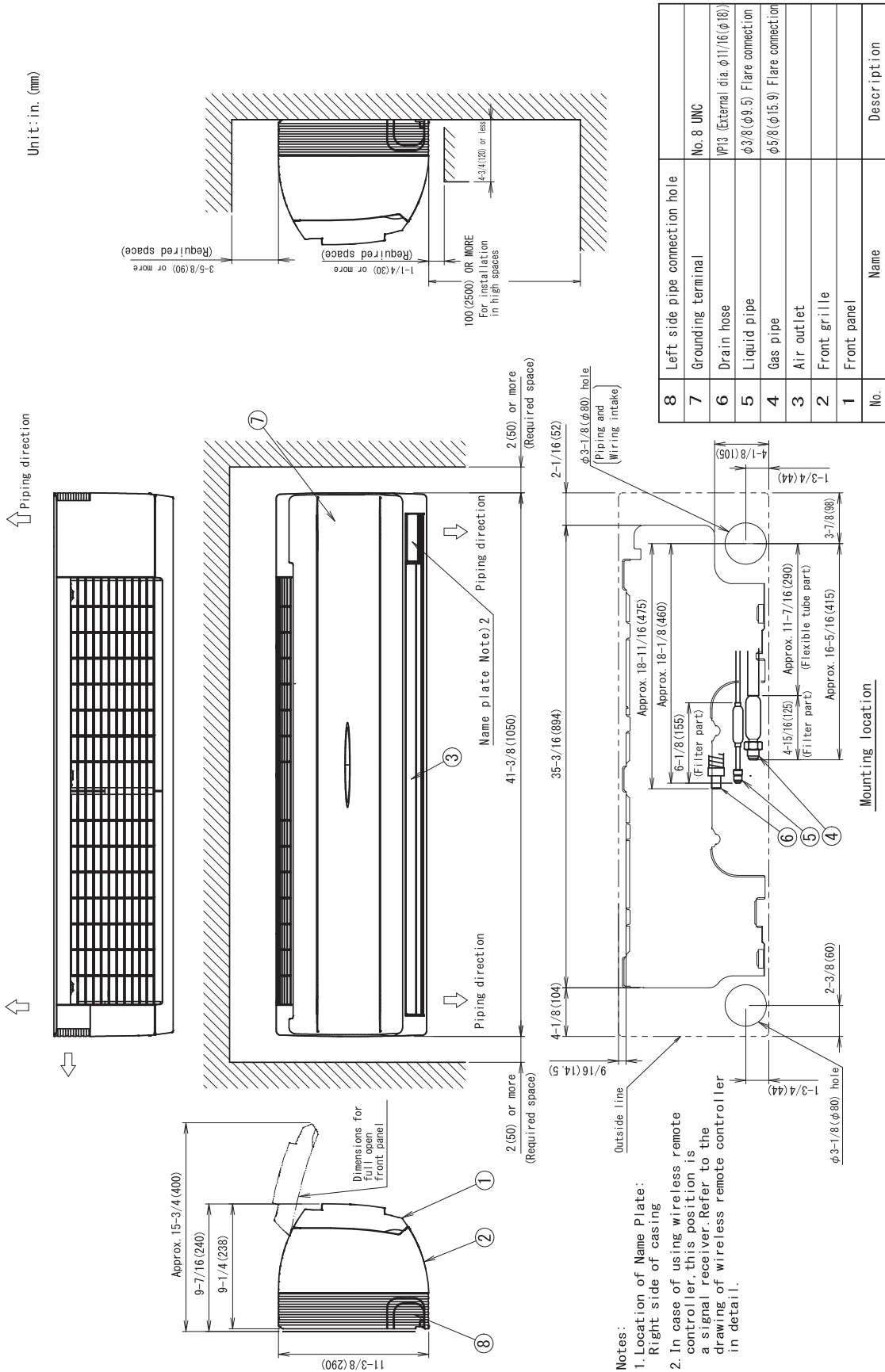

3D075390B

5.1.4 FBQ
FBQ18 - 24TBVJU

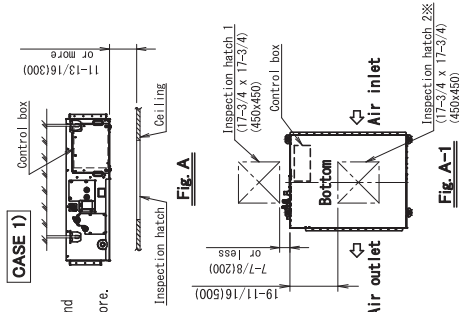

Fig. A-1

Notes) 1. Location of name plate : control box cover
 2. Make sure to mount an air filter inside air passage of the suction side.
 (Select duct collection efficiency (gravimetric method) 50% or more.)
 3. If the temperature and humidity in the ceiling is likely to exceed 86° F (30°C) and RH80%, reinforce thermal insulation by applying additional insulation materials such as glass wool or polyethylene that have thickness of 3/8(10) or more.
 4. Do not put anything that should not get wet under the indoor unit.
 Dew may drop when humidity reaches over 80%.
 Drain gets stuck or air filter is clogged.
 5. Space for service works
 Provide service space for service work such as check and maintenance of the control box and drain pump by one of the following ways.
 1) Inspection hatch 1 and 2 (17-3/4 x 17-3/4) (450x450) (Fig. A-1) and a space of 11-13/16(300mm) or more under the unit. (Fig. A) (Note) Inspection hatch 2 is not needed when there is a space for service work under the unit.
 2) Inspection hatch 1 (17-3/4 x 17-3/4) (450x450) on the control box side, and Inspection hatch 2 under the unit. (View B-1)
 3) Inspection hatch 3 under the unit and control box. (View B-2)
 • Provide enough space for maintenance and mount the drain pan and control box.
 • Check the drawing of optional accessories when mounting optional accessories such as filter chamber.

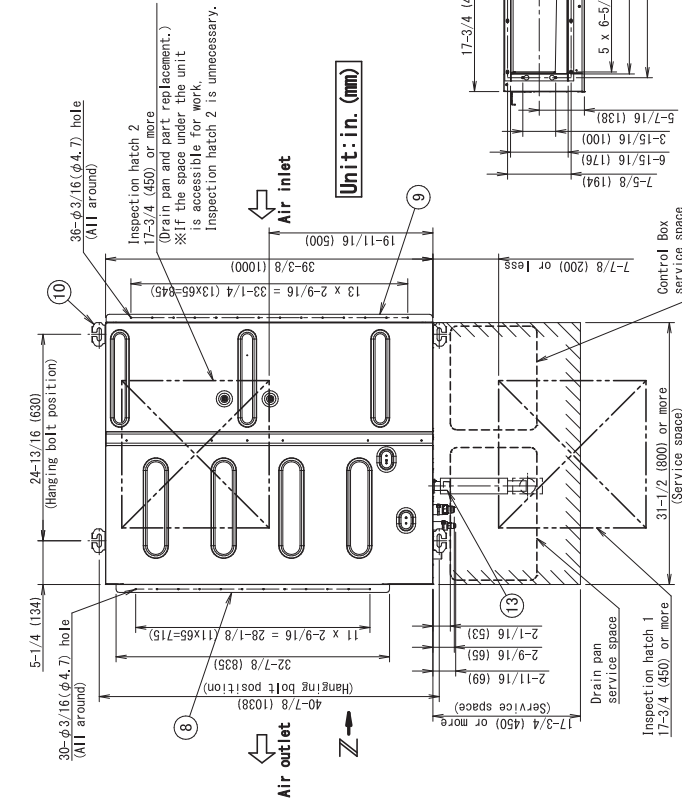
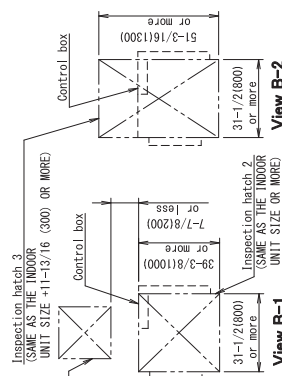
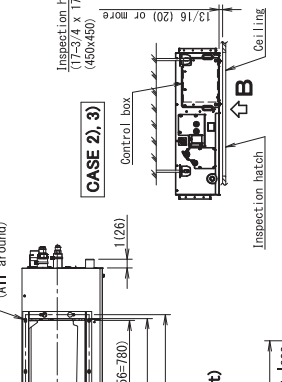

Fig. A-2

Unit: in. (mm)



View B-1



View B-2

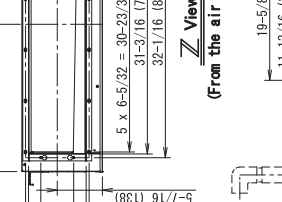

CASE 2) 3

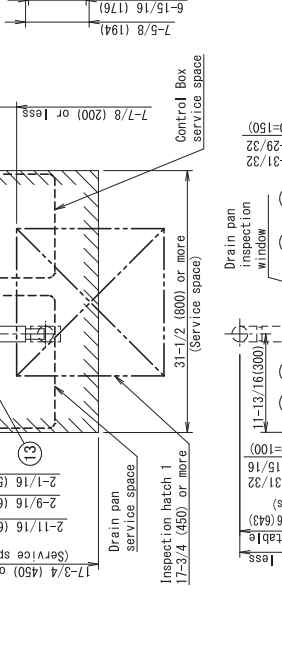

Z View

ITEM	PART NAME	REMARK
13	Drain socket	
12	Drain hose (Accessory)	
11	Socket (for maintenance)	O.D. φ1" (φ26) For M8-M10 or equivalent
10	Hanger bracket	
9	Air suction flange	
8	Air discharge flange	
7	Power supply wiring connection	
6	Transmission and remote controller wiring connection	
5	Control box (inside)	M
4	Ground terminal (Control box)	M
3	Drain pipe connection	O.D. φ=1-1/4" (φ32)
2	Gas pipe connection	φ5/8" (φ15.9) Flare connection
1	Liquid pipe connection	φ3/8" (φ9.5) Flare connection

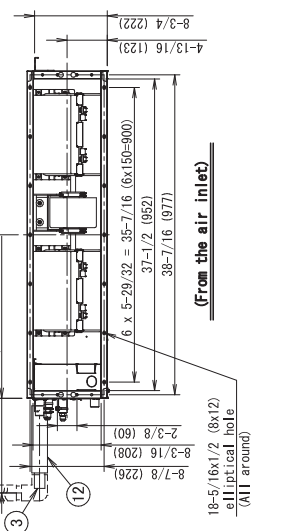

Fig. A-3

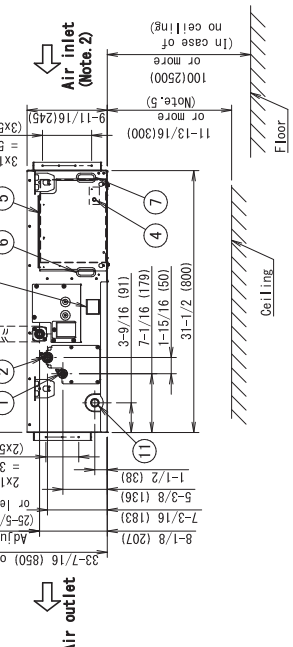
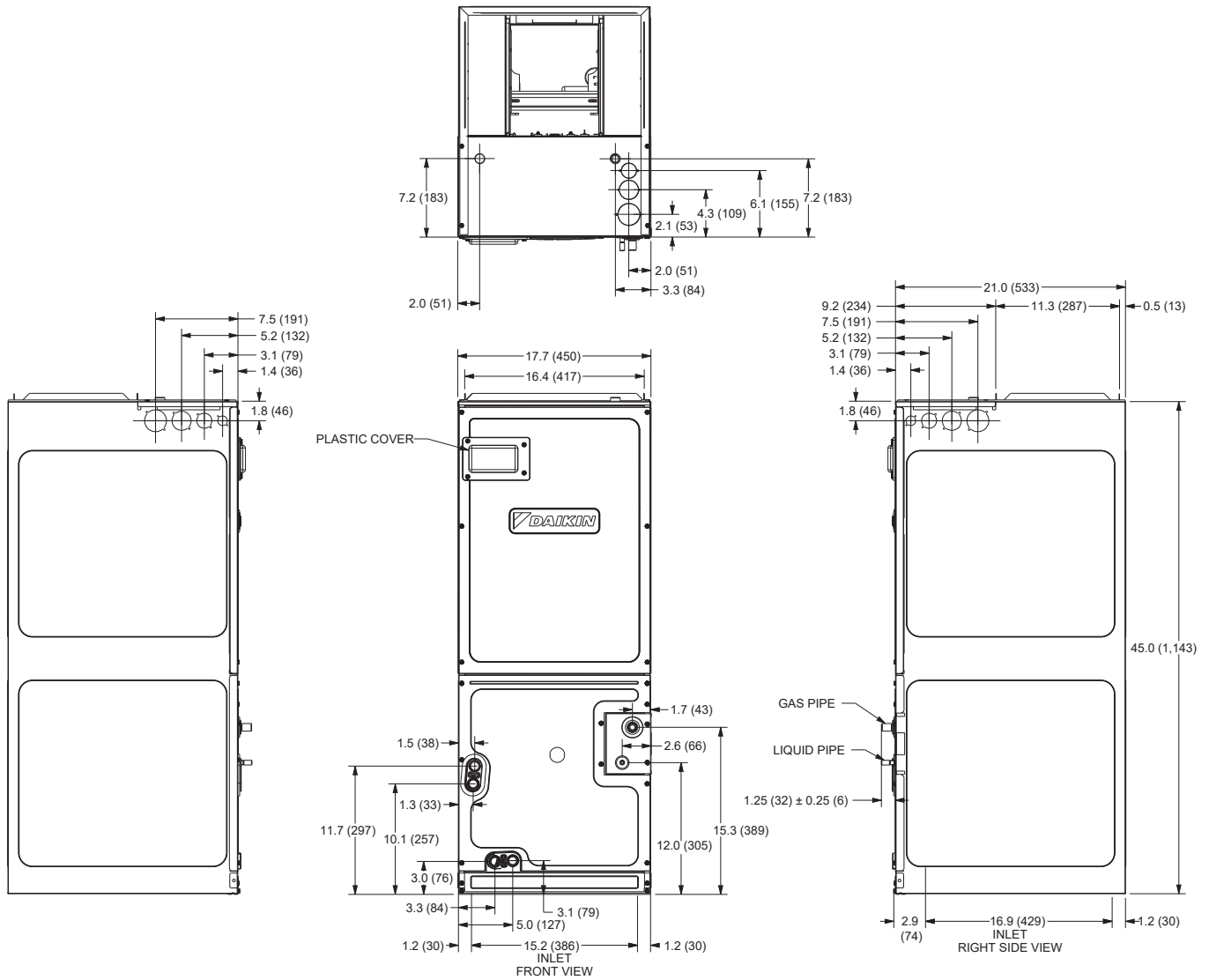

Fig. A-4

5.1.5 FTQ
FTQ18 - 36TAVJUD
FTQ18 - 36TAVJUA

Unit : in. (mm)



5.2 Wired Remote Controller (Accessory) BRC1E73

Unit: in.

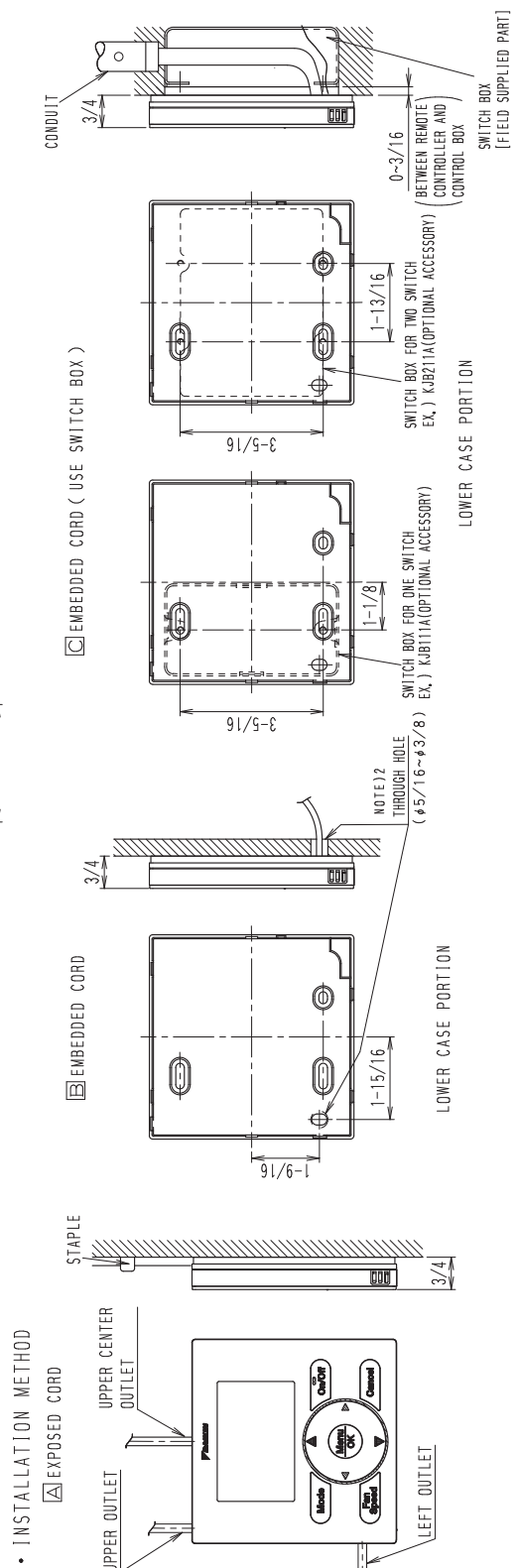
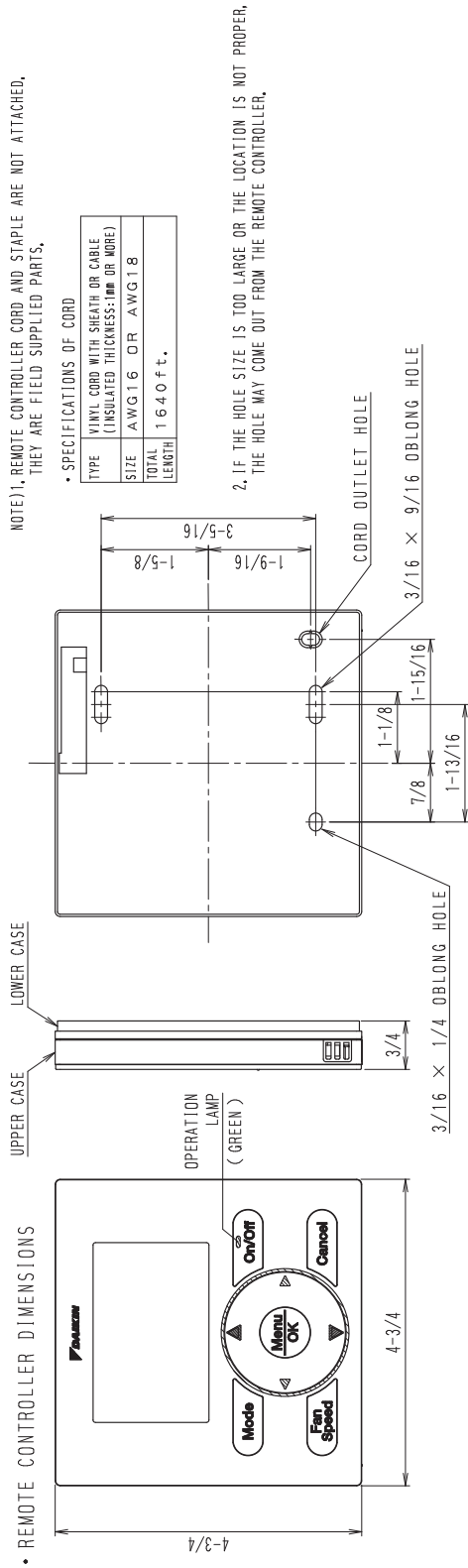

C: 3D091305A

BRC1H71W

Unit : in. (mm)

• REMOTE CONTROLLER DIMENSIONS

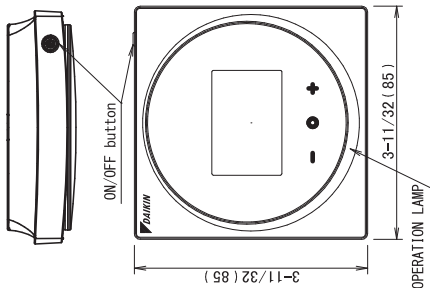

• PLASTIC COVER DIMENSIONS

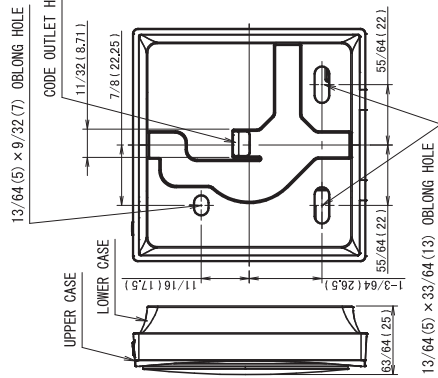

• MOUNTING PLATE DIMENSIONS

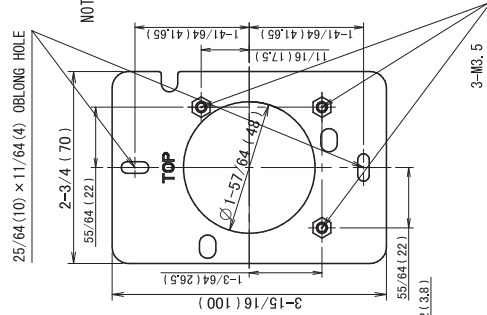

NOTE) 1. REMOTE CONTROLLER CORD AND STAPLE ARE NOT ATTACHED. THEY ARE FIELD SUPPLIED PARTS.

• SPECIFICATIONS OF CORD

TYPE	VINYL CORD WITH SHEATH OR CABLE (INSULATED THICKNESS: 1mm OR MORE)
SIZE	AWG 18
TOTAL LENGTH	16.40ft. (5.00m)

2. IF THE HOLE SIZE IS TOO LARGE OR THE LOCATION IS NOT PROPER, THE HOLE MAY COME OUT FROM THE REMOTE CONTROLLER.

• INSTALLATION METHOD

A EXPOSED CORD

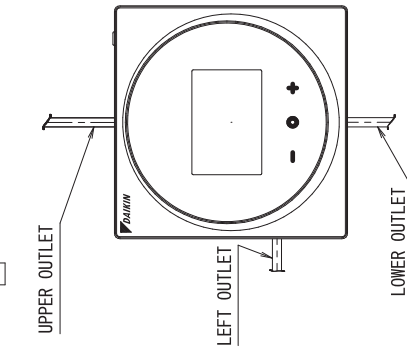

B EMBEDDED CORD

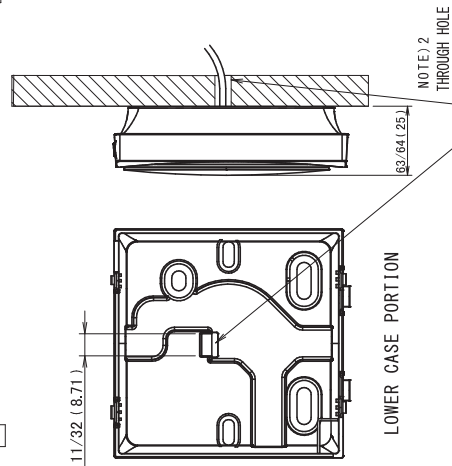

C EMBEDDED CORD (USE SWITCH BOX FOR ONE SWITCH)

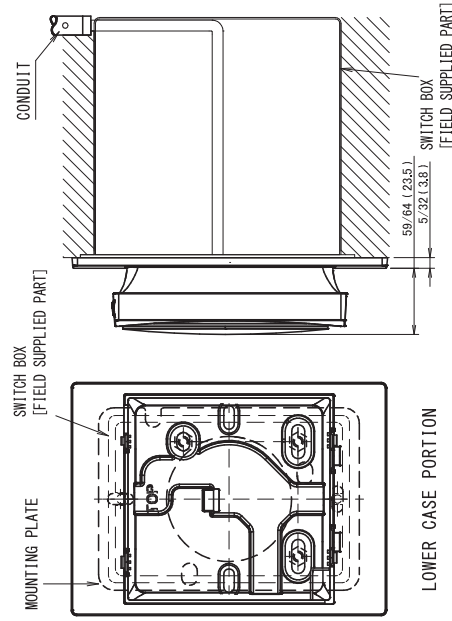

DTST-ONE-ADA-A

- Thermostat:

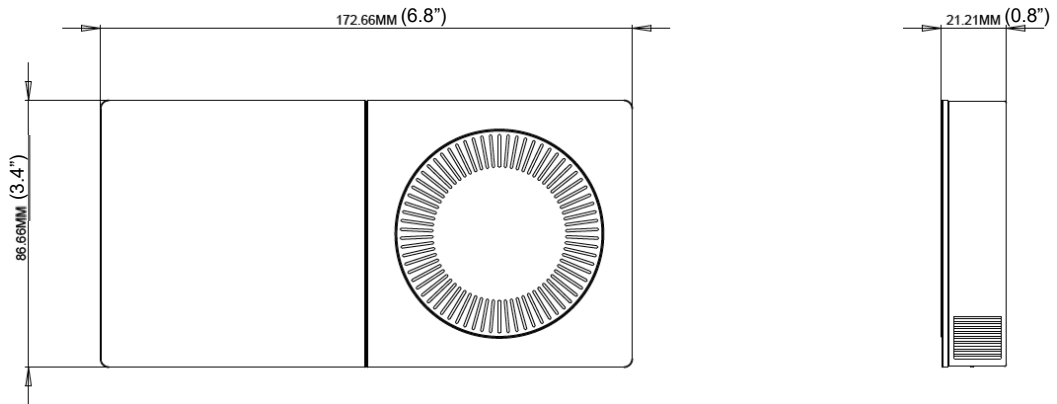

- Translation Adaptor:

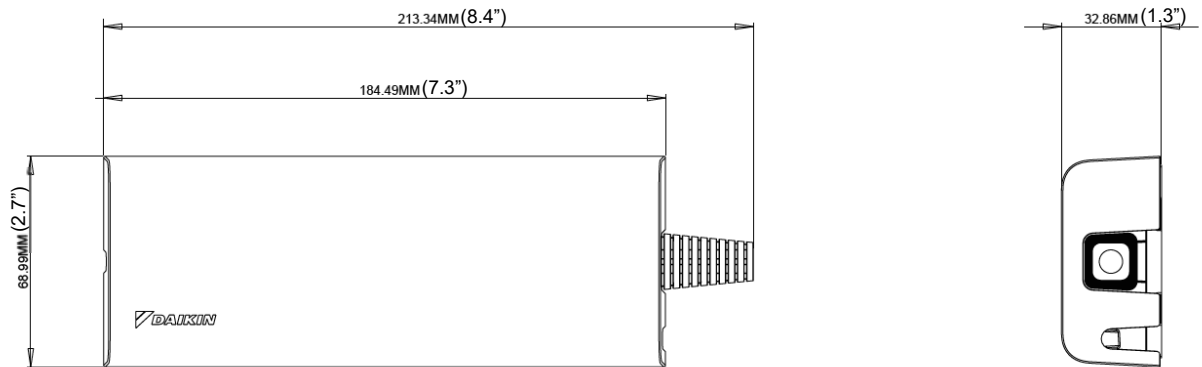

5.3 Wireless Remote Controller (Accessory) BRC7E818 (for FAQ)

Unit: in.

• RECEIVER INSTALLATION PROCEDURE
< MVJU Type >

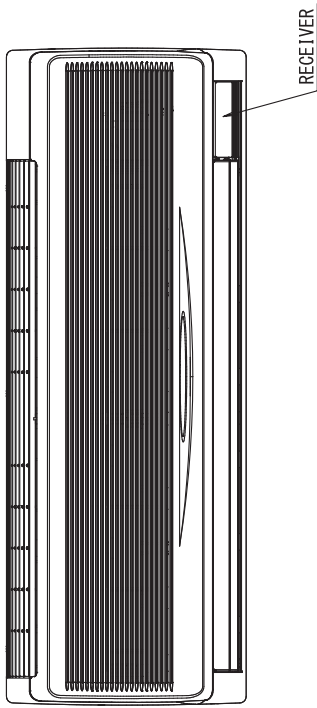

< PVJU • TAVJU Type >

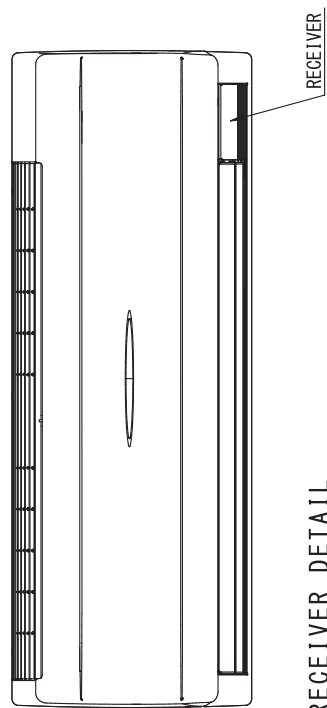

• RECEIVER DETAIL

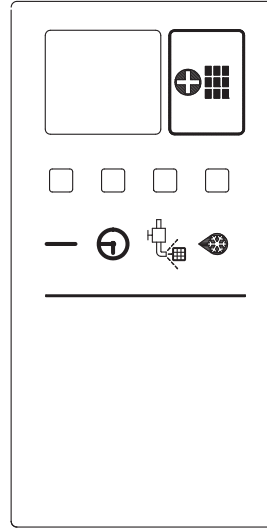

3D049736B

• REMOTE CONTROLLER DIMENSIONS

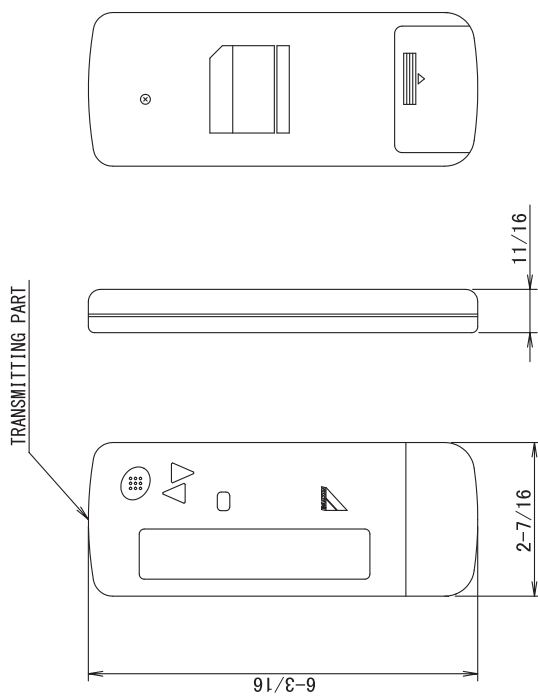

• REMOTE CONTROLLER HOLDER
INSTALLATION PROCEDURE
< INSTALLATION TO WALL SURFACE >

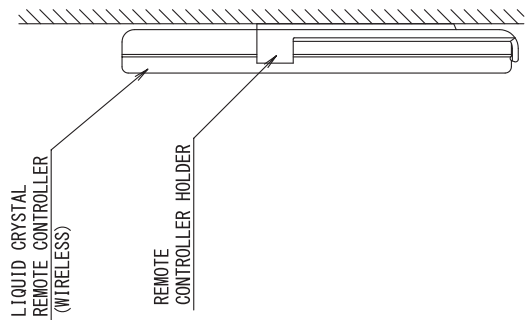

BRC4C82
BRC082A43

Unit: in.

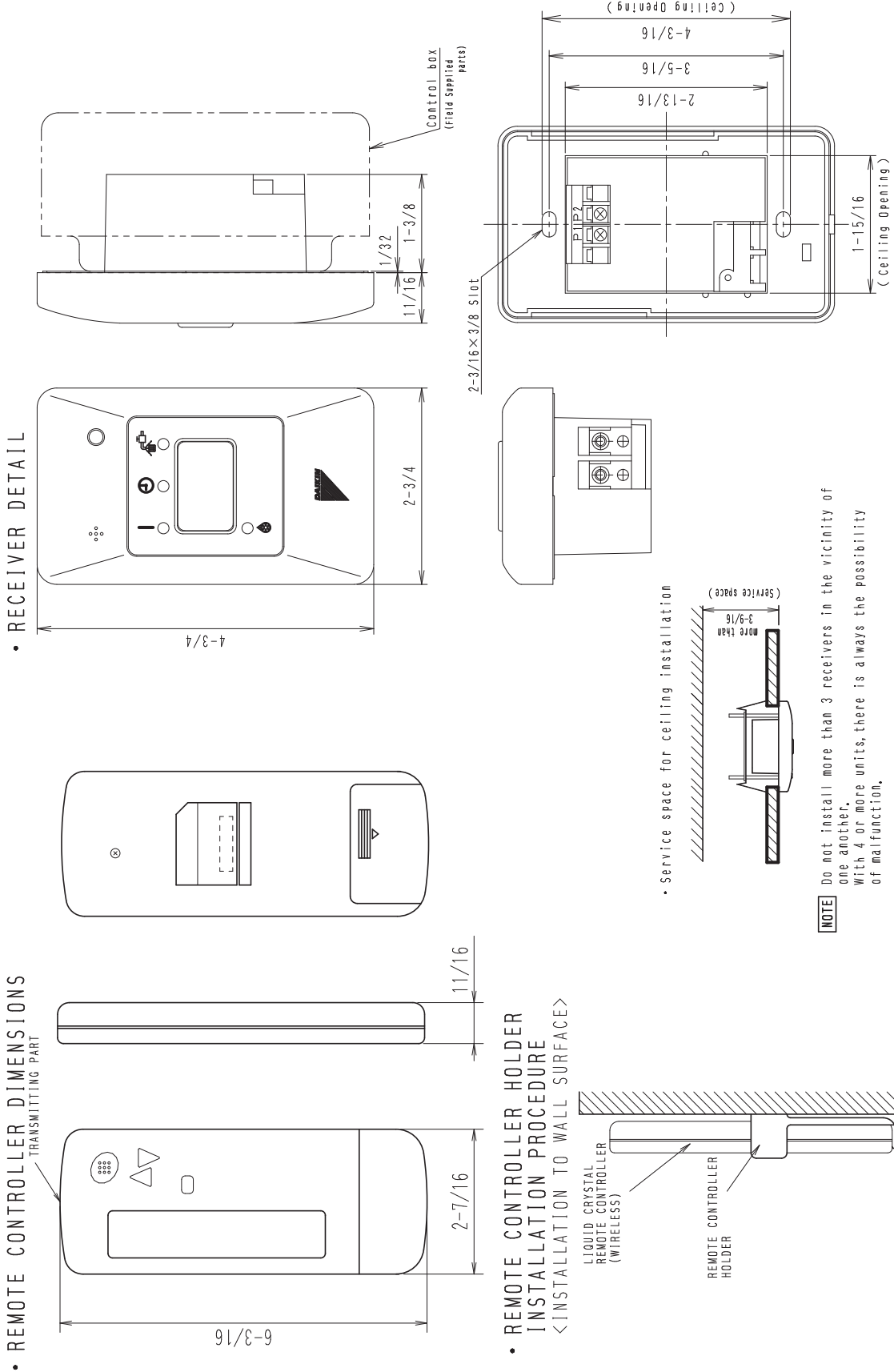

3D049611A

5.4 Outdoor Unit RZR18 - 24TBVJUA RZQ18 - 24TBVJUA

Unit: in. (mm)

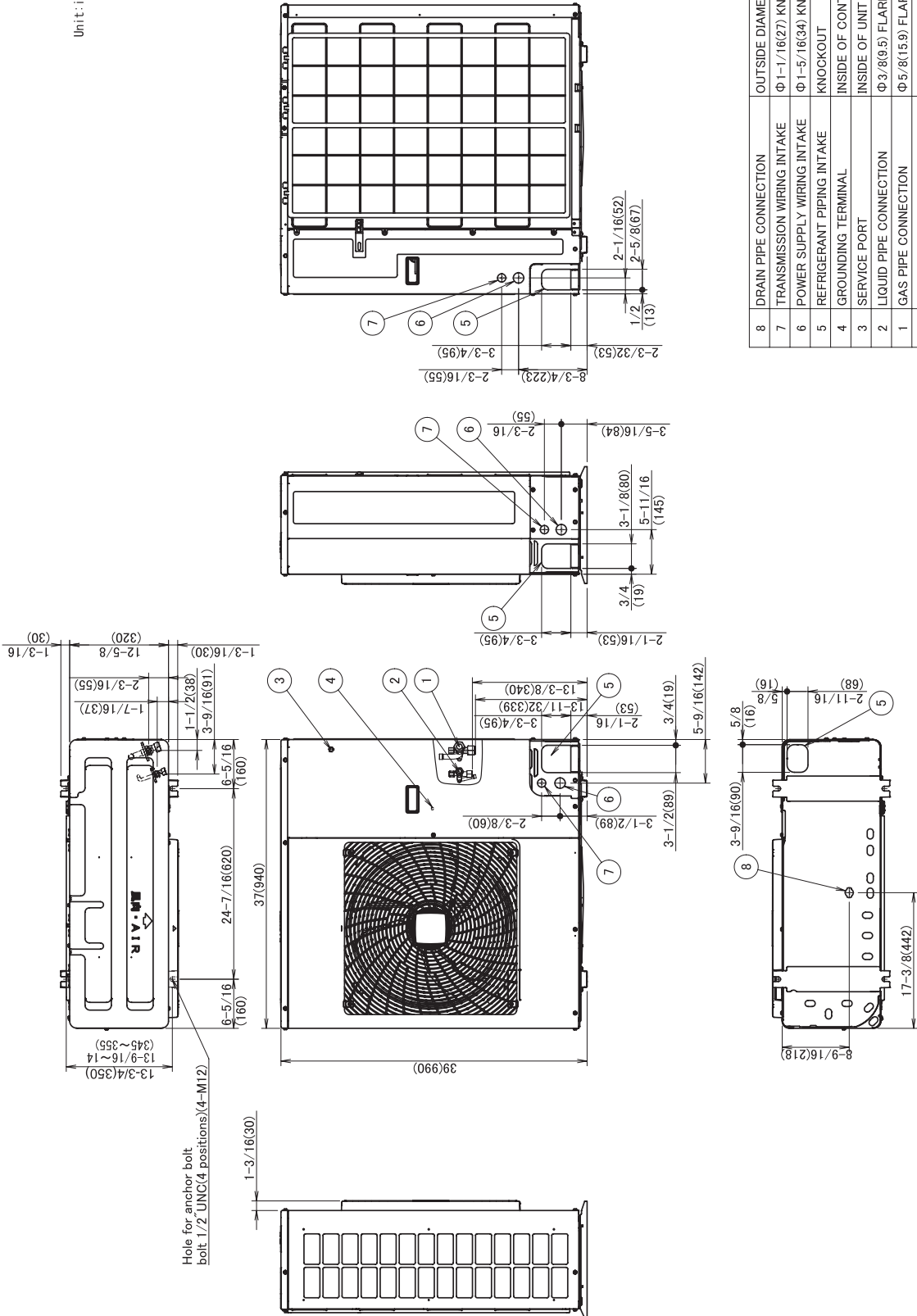

NO.	PARTS NAME	REMARKS
8	DRAIN PIPE CONNECTION	OUTSIDE DIAMETER Φ 1(26)
7	TRANSMISSION WIRING INTAKE	Φ 1-1/16(27) KNOCKOUT
6	POWER SUPPLY WIRING INTAKE	Φ 1-5/16(34) KNOCKOUT
5	REFRIGERANT PIPING INTAKE	KNOCKOUT
4	GROUNDING TERMINAL	INSIDE OF CONTROL BOX(M6)
3	SERVICE PORT	INSIDE OF UNIT
2	LIQUID PIPE CONNECTION	Φ 3/8(9.5) FLARE
1	GAS PIPE CONNECTION	Φ 5/8(15.9) FLARE

3D126496

RZR30 - 48TBVJUA
RZQ30 - 48TBVJUA

Unit: in. (mm)

NOTE: GAS PIPE CONNECTION IS IN THE ACCESSORY SET.
LIQUID PIPE CONNECTION IS THE SITE PROVIDES.

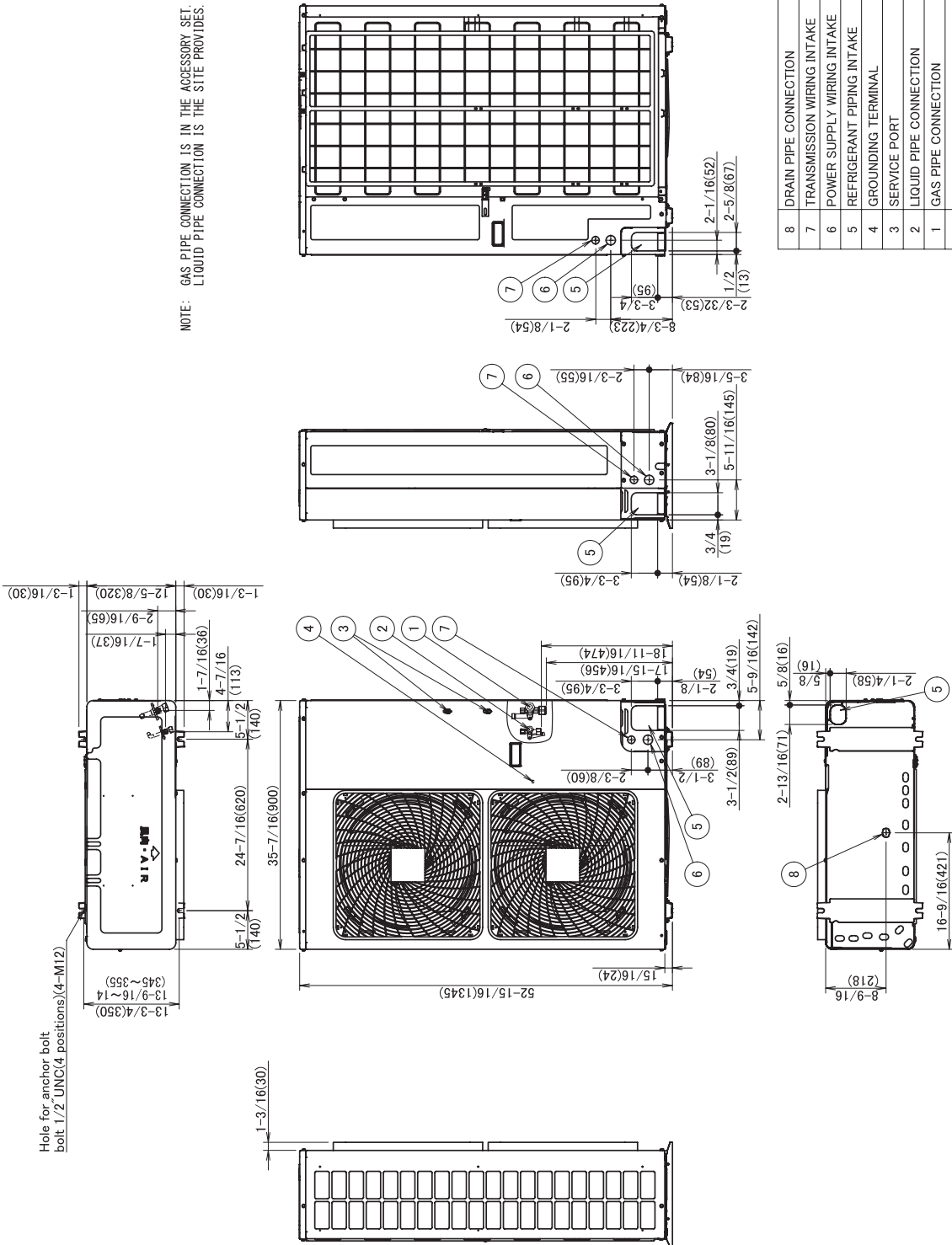

Hole for anchor bolt.
bolt: 1/2 UNC(4 positions)(4-M12)

NO.	PARTS NAME	REMARKS
1	GAS PIPE CONNECTION	Φ5/8(15.9) FLARE
2	LIQUID PIPE CONNECTION	Φ3/8(9.5) FLARE
3	SERVICE PORT	INSIDE OF UNIT
4	GROUNDING TERMINAL	INSIDE OF CONTROL BOX(M5)
5	REFRIGERANT PIPING INTAKE	KNOCKOUT
6	POWER SUPPLY WIRING INTAKE	Φ1-5/16(34) KNOCKOUT
7	TRANSMISSION WIRING INTAKE	Φ1-1/16(27) KNOCKOUT
8	DRAIN PIPE CONNECTION	OUTSIDE DIAMETER Φ1(26)

3D126498

6. Installation Service Space

RZR18 - 24TBVJUA
RZQ18 - 24TBVJUA

REQUIRED INSTALLATION SPACE

The unit of the values is inch(mm).

1. Where there is an obstacle on the suction side:

(a) No obstacle above

- (1) Stand-alone installation
- Obstacle on the suction side only

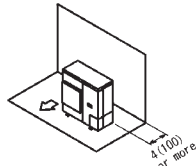

- Obstacle on both sides

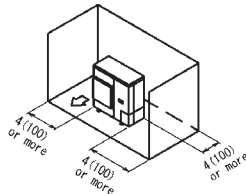

(2) Series installation

- (2 or more)
- Obstacle on both sides

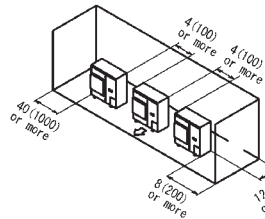

(b) Obstacle above, too

- (1) Stand-alone installation
- Obstacle on the suction side, too

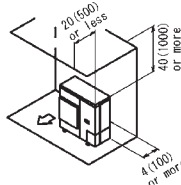

- Obstacle on the suction side and both sides

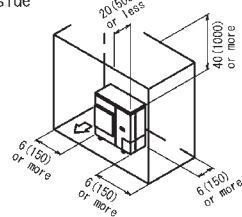

(2) Series installation

- (2 or more)
- Obstacle on the suction side and both sides

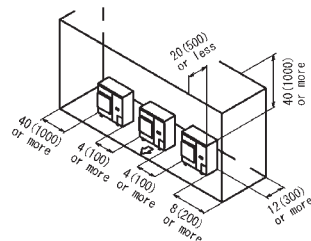

2. Where there is an obstacle on the discharge side:

(a) No obstacle above

- (1) Stand-alone installation

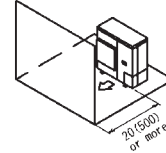

- (2) Series installation
- (2 or more)

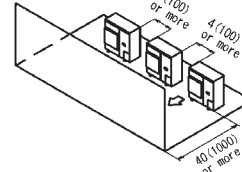

(b) Obstacle above, too

- (1) Stand-alone installation

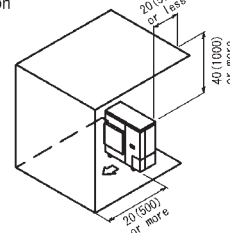

- (2) Series installation
- (2 or more)

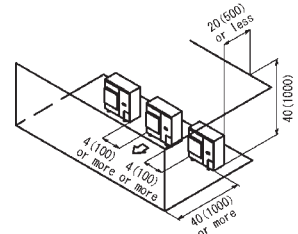

3. Where there are obstacles on both suction side and discharge sides:

Pattern 1

Where the obstacles on the discharge side is higher than the unit:
(There is no height limit for obstructions on the intake side.)

(a) No obstacle above

- (1) Stand-alone installation

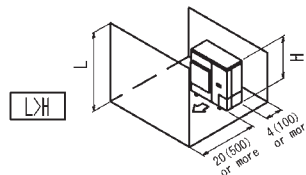

- (2) Series installation
- (2 or more)

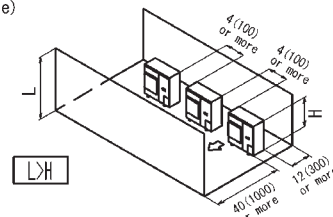

RZR18 - 24TBVJUA, continued
RZQ18 - 24TBVJUA, continued

(b) Obstacle above, too
 (1) Stand-alone installation

The relations between H, A and L are as follows:

	L	A
$L \leq H$	$0 < L \leq 1/2H$	30 (750)
	$1/2H < L \leq H$	40 (1000)
$H < L$	Set the stand as: $L \leq H$	

Close the bottom of the installation frame to prevent the discharged air from being bypassed.

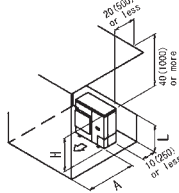

(2) Series installation
 (2 or more)

The relations between H, A and L are as follows:

	L	A
$L \leq H$	$0 < L \leq 1/2H$	40 (1000)
	$1/2H < L \leq H$	50 (1250)
$H < L$	Set the stand as: $L \leq H$	

Close the bottom of the installation frame to prevent the discharged air from being bypassed.

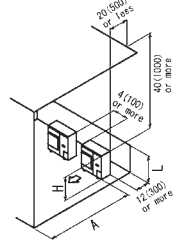

Only two units can be installed for this series.

Pattern Z

Where the obstacles on the discharge side is lower than the unit:
 (There is no height limit for obstructions on the intake side.)

(a) No obstacle above
 (1) Stand-alone installation



(2) Series installation
 (2 or more)

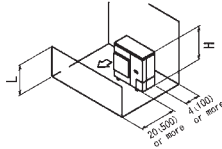

The relations between H, A and L are as follows:

	L	A
	$0 < L \leq 1/2H$	10 (250)
	$1/2H < L \leq H$	12 (300)

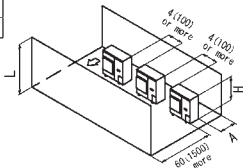

(b) Obstacle above, too
 (1) Stand-alone installation

The relations between H, A and L are as follows:

	L	A
$L \leq H$	$0 < L \leq 1/2H$	4 (100)
	$1/2H < L \leq H$	8 (200)
$H < L$	Set the stand as: $L \leq H$	

Close the bottom of the installation frame to prevent the discharged air from being bypassed.

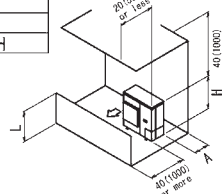

(2) Series installation

The relations between H, A and L are as follows:

	L	A
$L \leq H$	$0 < L \leq 1/2H$	10 (250)
	$1/2H < L \leq H$	12 (300)
$H < L$	Set the stand as: $L \leq H$	

Close the bottom of the installation frame to prevent the discharged air from being bypassed.

Only two units can be installed for this series.

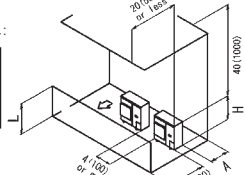

4. Double-decker installation

(a) Obstacle on the discharge side
 Close the gap Z (the gap between the upper and lower outdoor units) to prevent the discharged air from being bypassed.

Do not stack more than two unit.

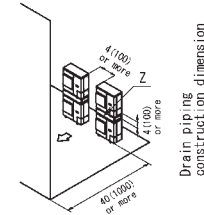

Drain piping construction dimension

(b) Obstacle on the suction side
 Close the gap Z (the gap between the upper and lower outdoor units) to prevent the discharged air from being bypassed.

Do not stack more than two unit.

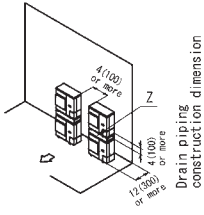

Drain piping construction dimension

5. Multiple rows of series installation (on the rooftop, etc.)

(a) One row of stand-alone installation

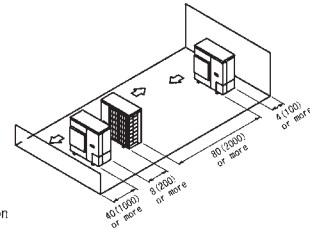

(b) Rows of series installation
 (2 or more)

The relations between H, A and L are as follows:

	L	A
$L \leq H$	$0 < L \leq 1/2H$	10 (250)
	$1/2H < L \leq H$	12 (300)
$H < L$	Cannot be installed	

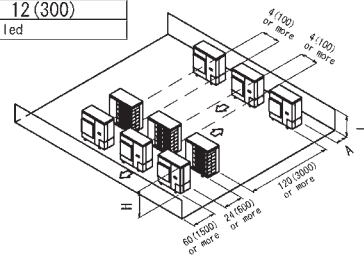

RZR30 - 48TBVJUA
RZQ30 - 48TBVJUA

REQUIRED INSTALLATION SPACE

The unit of the values is inch(mm).

1. Where there is an obstacle on the suction side:

(a) No obstacle above

- (1) Stand-alone installation
- Obstacle on the suction side only

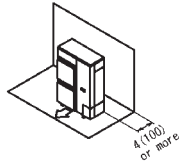

-Obstacle on both sides

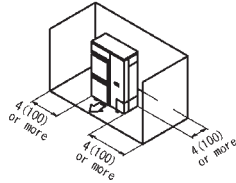

- (2) Series installation
- (2 or more)
- Obstacle on both sides

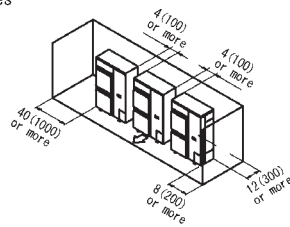

(b) Obstacle above, too

- (1) Stand-alone installation
- Obstacle on the suction side, too

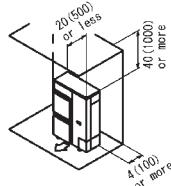

-Obstacle on the suction side and both sides

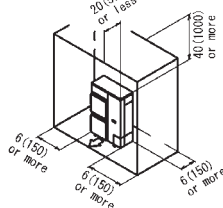

- (2) Series installation
- (2 or more) (NOTE)
- Obstacle on the suction side and both sides

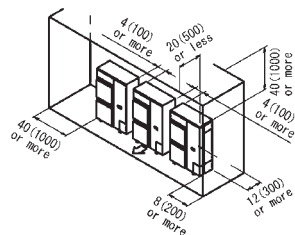

2. Where there is an obstacle on the discharge side:

(a) No obstacle above

- (1) Stand-alone installation

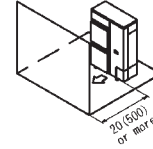

- (2) Series installation
- (2 or more)

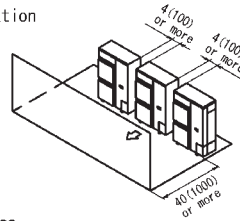

(b) Obstacle above, too

- (1) Stand-alone installation

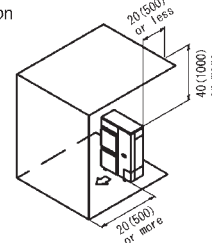

- (2) Series installation
- (2 or more) (NOTE)

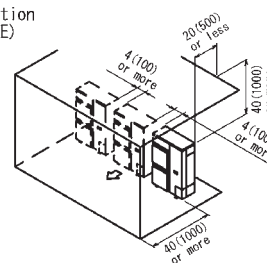

3. Where there are obstacles on both suction side and discharge sides:

Pattern 1

Where the obstacles on the discharge side is higher than the unit:
(There is no height limit for obstructions on the intake side.)

(a) No obstacle above

- (1) Stand-alone installation

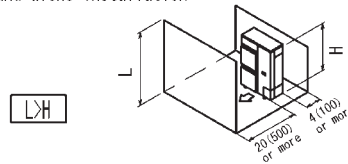

- (2) Series installation
- (2 or more) (NOTE)

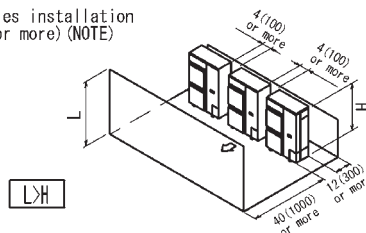

RZR30 - 48TBVJUA, continued
RZQ30 - 48TBVJUA, continued

(b) Obstacle above, too
 (1) Stand-alone installation

The relations between H, A and L are as follows:

	L	A
$L \leq H$	$0 < L \leq 1/2H$	30 (750)
	$1/2H < L \leq H$	40 (1000)
$H < L$	Set the stand as: $L \leq H$	

Close the bottom of the installation frame to prevent the discharged air from being bypassed.

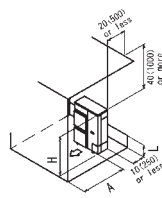

The relations between H, A and L are as follows:

	L	A
$L \leq H$	$0 < L \leq 1/2H$	40 (1000)
	$1/2H < L \leq H$	50 (1250)
$H < L$	Set the stand as: $L \leq H$	

Close the bottom of the installation frame to prevent the discharged air from being bypassed.

Only two units can be installed for this series.

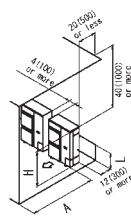

Pattern Z

Where the obstacles on the discharge side is lower than the unit:
 (There is no height limit for obstructions on the intake side.)

(a) No obstacle above
 (1) Stand-alone installation

$L \leq H$

(2) Series installation
 (2 or more) (NOTE)

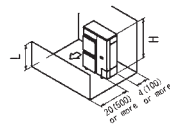

The relations between H, A and L are as follows:

	L	A
$L \leq H$	$0 < L \leq 1/2H$	10 (250)
	$1/2H < L \leq H$	12 (300)

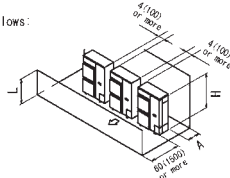

(b) Obstacle above, too
 (1) Stand-alone installation

The relations between H, A and L are as follows:

	L	A
$L \leq H$	$0 < L \leq 1/2H$	4 (100)
	$1/2H < L \leq H$	8 (200)
$H < L$	Set the stand as: $L \leq H$	

Close the bottom of the installation frame to prevent the discharged air from being bypassed.

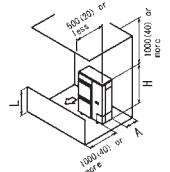

(NOTE) When install the units in a line, have to leave the distance over 4(100) between the two units.

(2) Series installation (NOTE)

The relations between H, A and L are as follows:

	L	A
$L \leq H$	$0 < L \leq 1/2H$	10 (250)
	$1/2H < L \leq H$	12 (300)
$H < L$	Set the stand as: $L \leq H$	

Close the bottom of the installation frame to prevent the discharged air from being bypassed.

Only two units can be installed for this series.

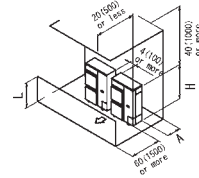

4. Double-decker installation

(a) Obstacle on the discharge side (NOTE)

Close the gap Z (the gap between the upper and lower outdoor units) to prevent the discharged air from being bypassed.

Do not stack more than two unit.

Set the board (field supply) as the detail A between two units to prevent the drainage from freezing.

Leave the enough space between the layer one and the board.

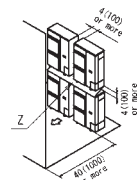

(b) Obstacle on the suction side (NOTE)

Close the gap Z (the gap between the upper and lower outdoor units) to prevent the discharged air from being bypassed.

Do not stack more than two unit.

Set the board (field supply) as the detail A between two units to prevent the drainage from freezing.

Leave the enough space between the layer one and the board.

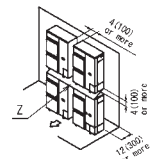

5. Multiple rows of series installation (on the rooftop, etc.)

(a) One row of stand-alone installation

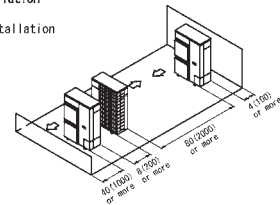

(b) Rows of series installation
 (2 or more)

The relations between H, A and L are as follows:

	L	A
$L \leq H$	$0 < L \leq 1/2H$	10 (250)
	$1/2H < L \leq H$	12 (300)
$H < L$	Cannot be installed	

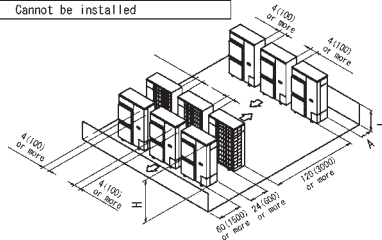

7. Center of Gravity

7.1 Indoor Unit

FCQ18 - 48AAVJU

Unit : in. (mm)

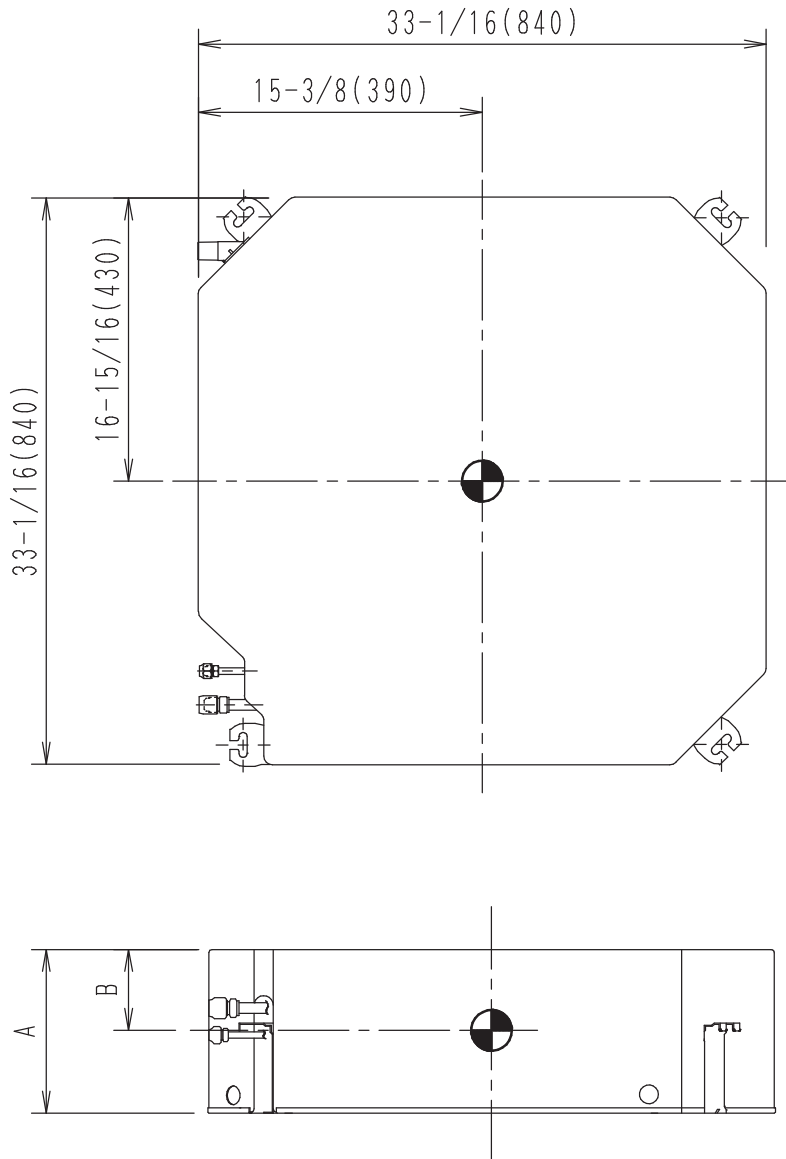

MODEL NAME	A	B
FXFQ07~24AAVJU FCQ18・24AAVJU	9-11/16 (246)	3-9/16 (90)
FXFQ30~54AAVJU FCQ30~48AAVJU	11-5/16 (288)	4-3/4 (120)

FBQ18 - 48TBVJU

in. (mm)

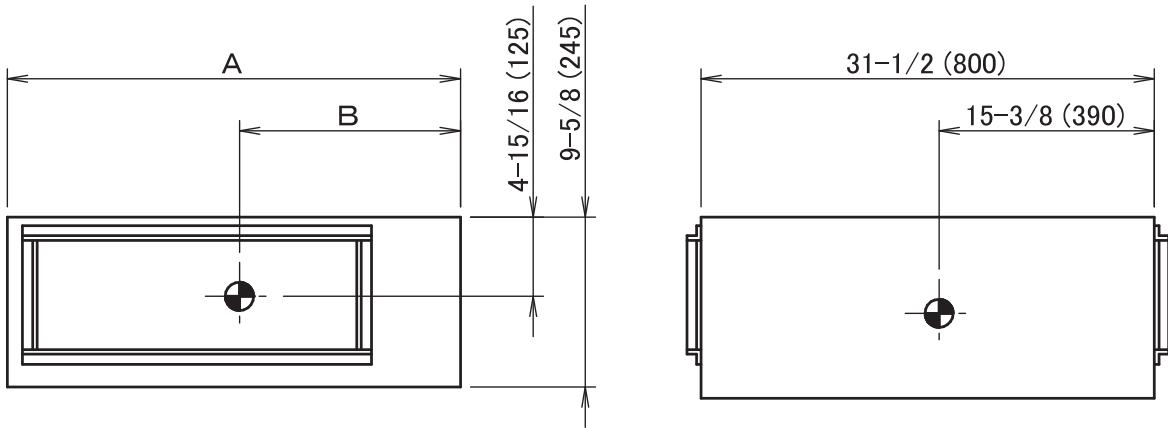

MODEL NAME	A	B
FBQ18 · 24TBVJU	39-3/8 (1000)	18-11/16 (475)
FBQ30 · 36 · 42 · 48TBVJU	55-1/8 (1400)	24-7/16 (620)

7.2 Outdoor Unit

RZR18 - 24TBVJUA
RZQ18 - 24TBVJUA

Unit: in. (mm)

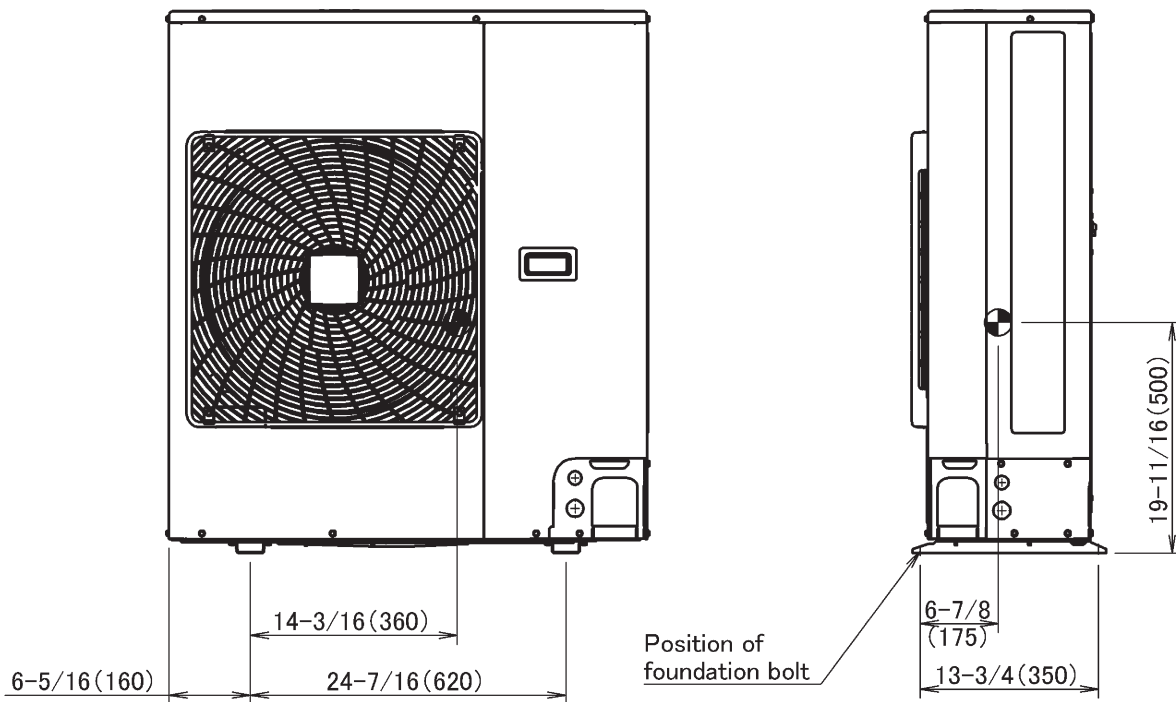

RZR30 - 48TBVJUA
RZQ30 - 48TBVJUA

Unit: in. (mm)

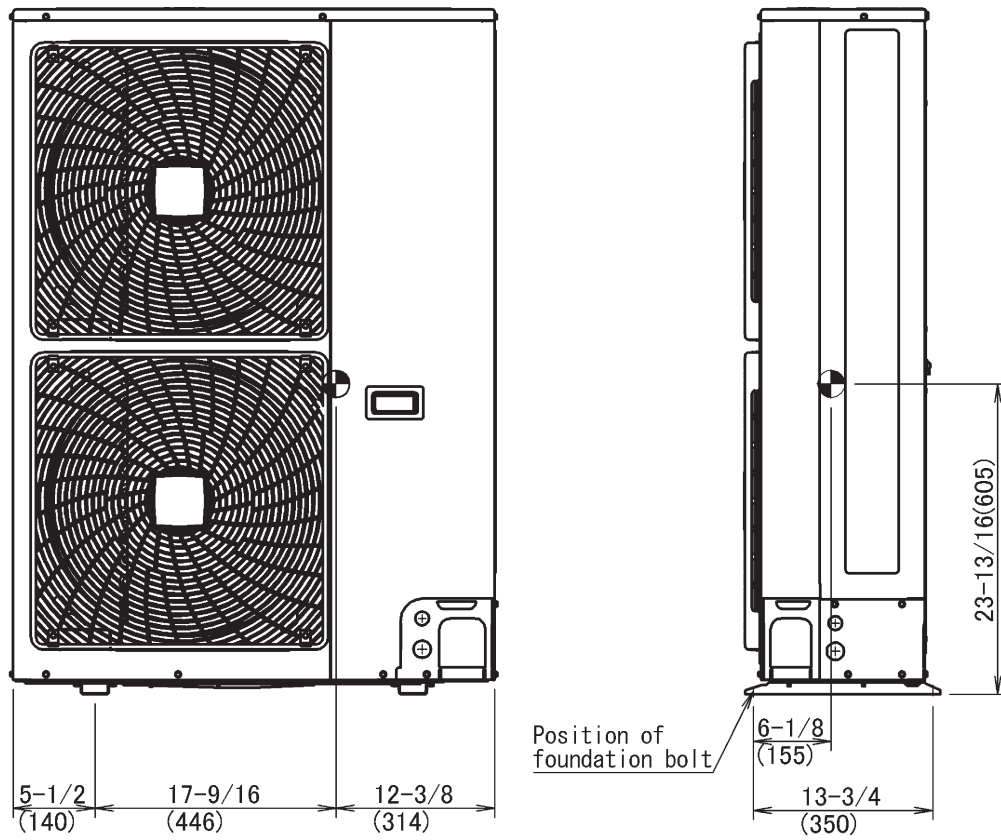

8. Piping Diagrams

8.1 Indoor Unit

FCQ18 - 48AAVJU

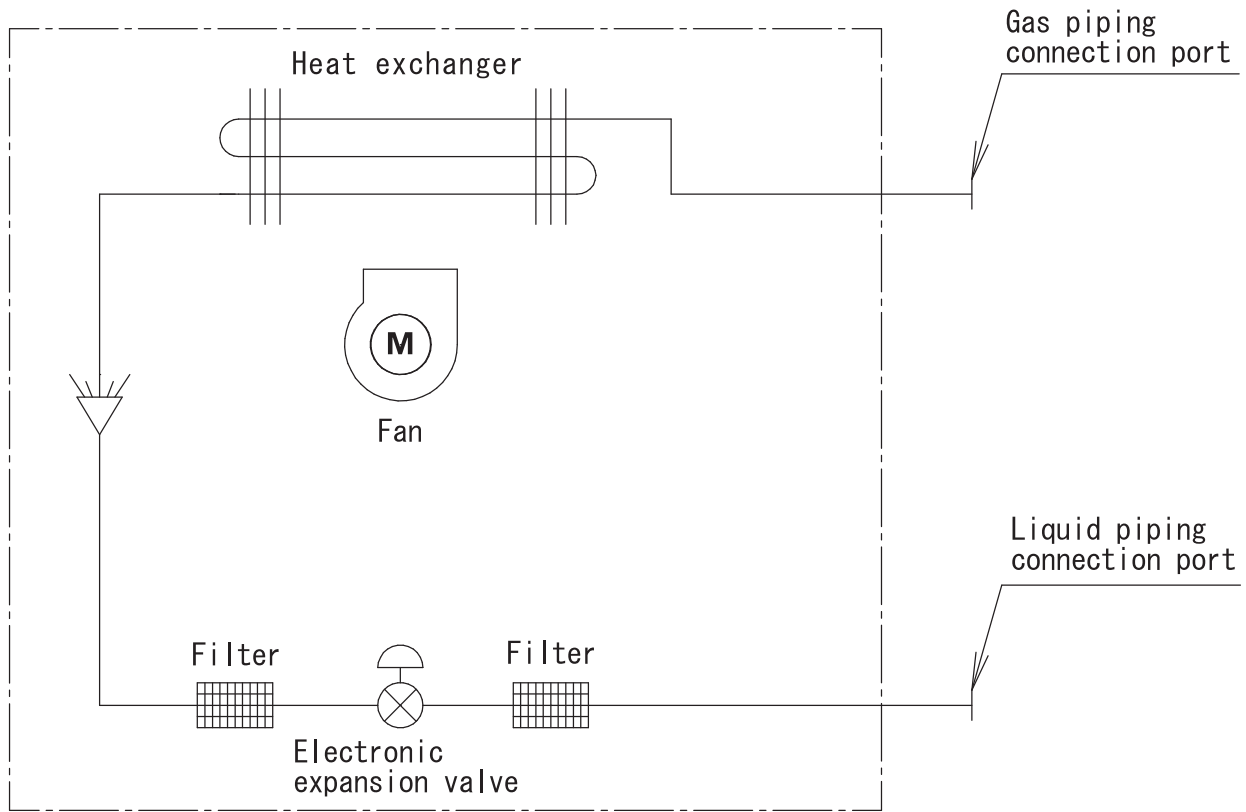

4D140941

Unit: in. (mm)

Model	Gas	Liquid
FCQ18 - 48AAVJU	φ5/8 (φ15.9)	φ3/8 (φ9.5)

FAQ18 - 24TAVJU

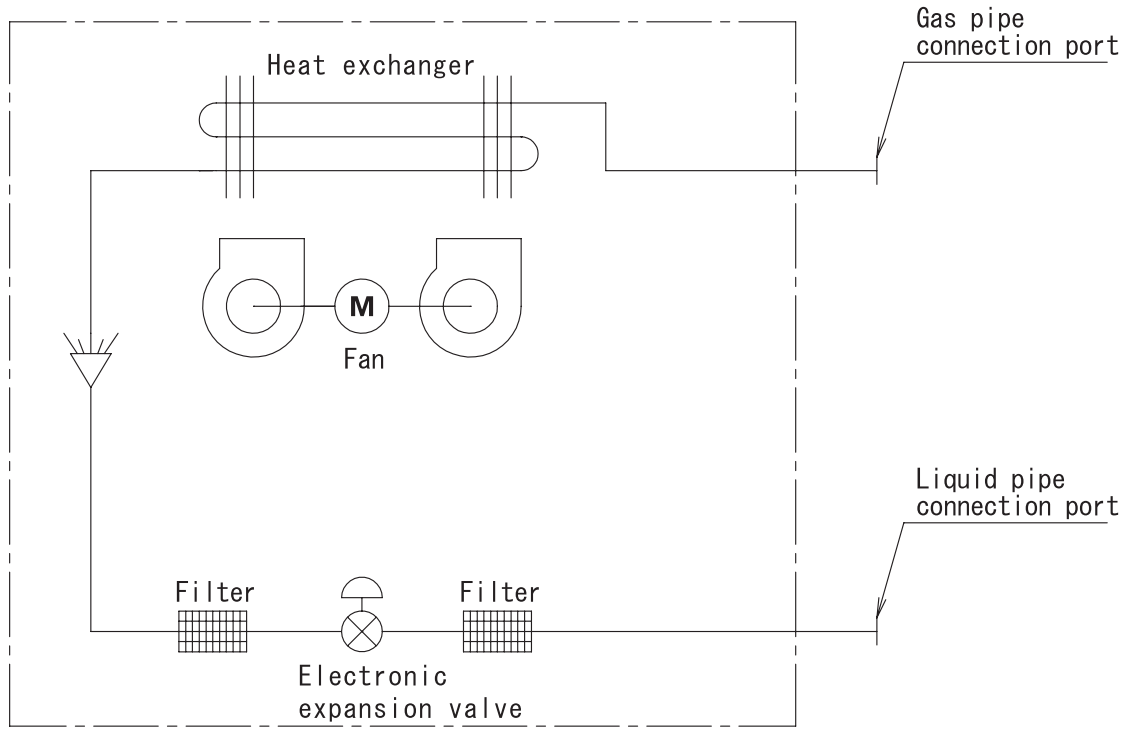

C: 4D034245R

Unit: in. (mm)

Model	Gas	Liquid
FAQ18 - 24TAVJU	$\phi 5/8$ $(\phi 15.9)$	$\phi 3/8$ $(\phi 9.5)$

FBQ18 - 48TBVJU

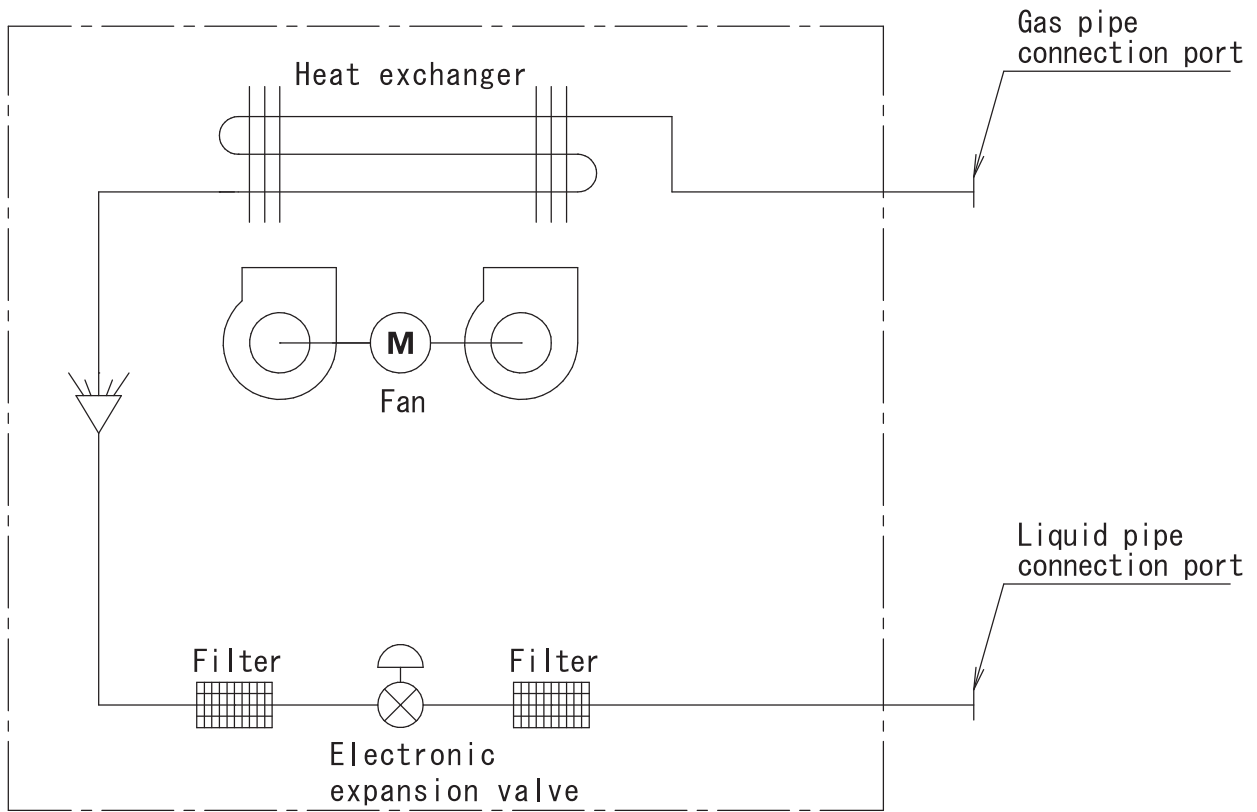

4D141716

Unit: in. (mm)

Model	Gas	Liquid
FBQ18 - 48TBVJU	ϕ5/8 (ϕ15.9)	ϕ3/8 (ϕ9.5)

FTQ18 - 48TAVJUD
FTQ18 - 48TAVJUA

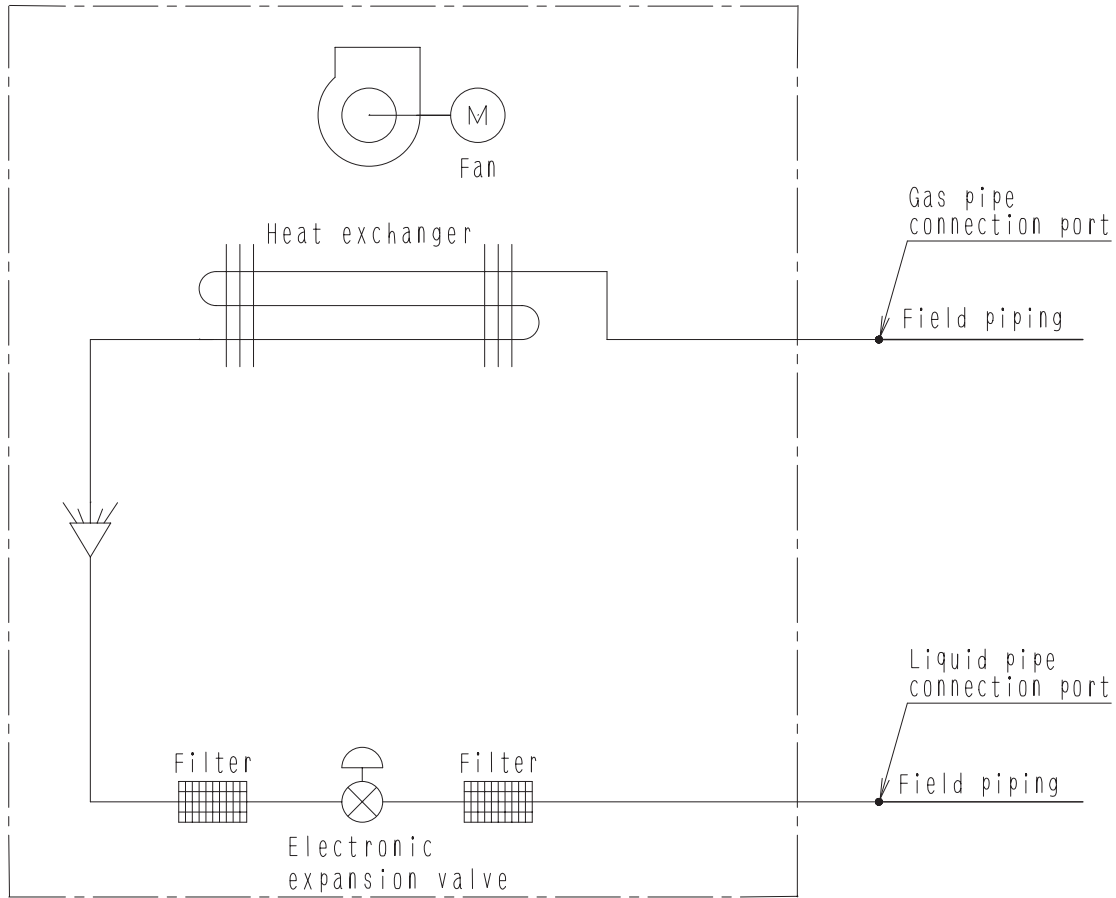

APPLICABLE MODEL

FTQ_TA

C: 4D068194

Unit: in. (mm)

Model	Gas	Liquid
FTQ18 - 48TAVJUD	φ5.8	φ3.8
FTQ18 - 48TAVJUA	(φ15.9)	(φ9.5)

8.2 Outdoor Unit
RZR18 - 24TBVJUA
RZQ18 - 24TBVJUA

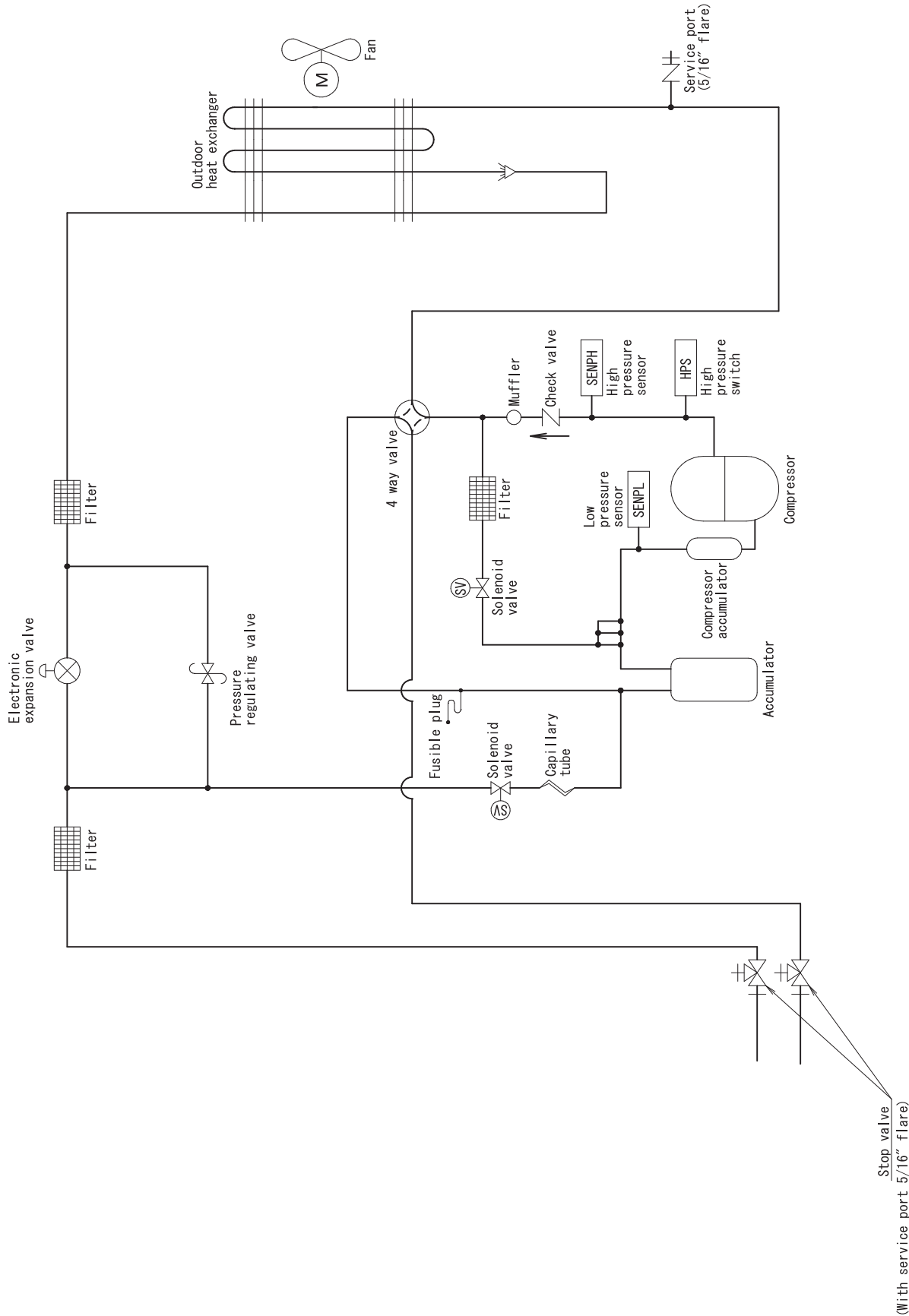

3D132130

RZR30 - 48TBVJUA
RZQ30 - 48TBVJUA

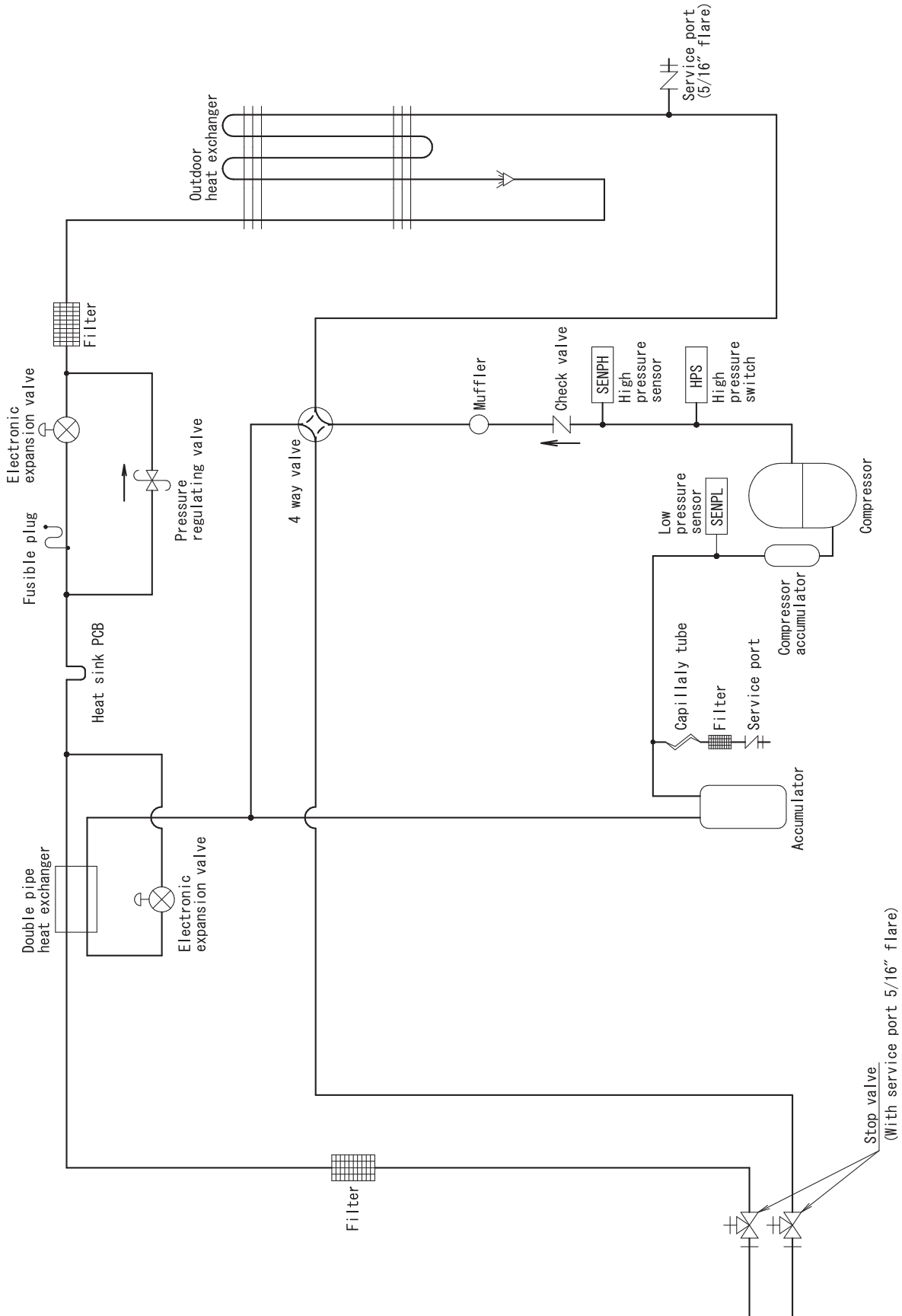

3D132132

9. Wiring Diagrams

9.1 Indoor Unit FCQ18 - 48AAVJU

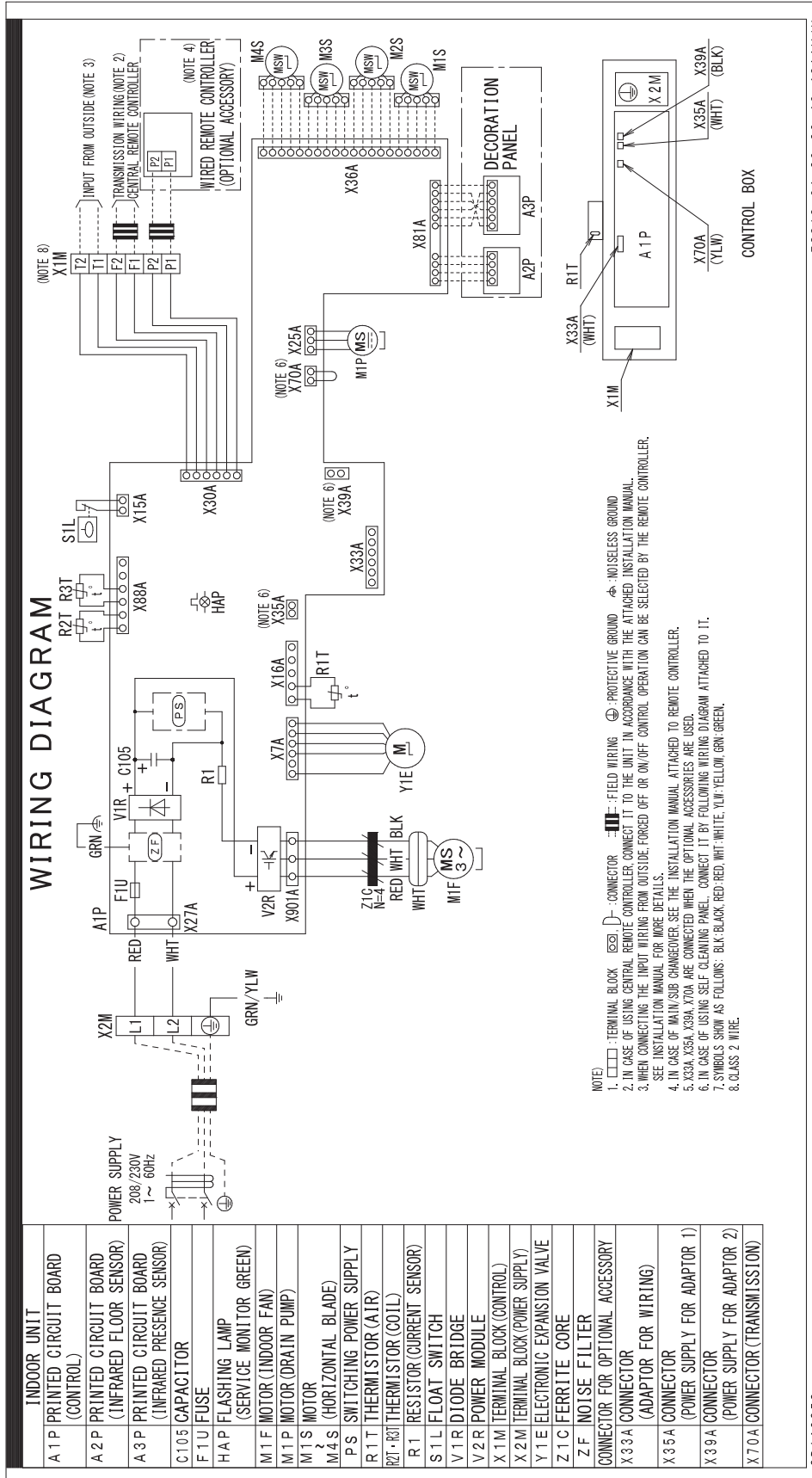

3D142358

FAQ18 - 24TAVJU

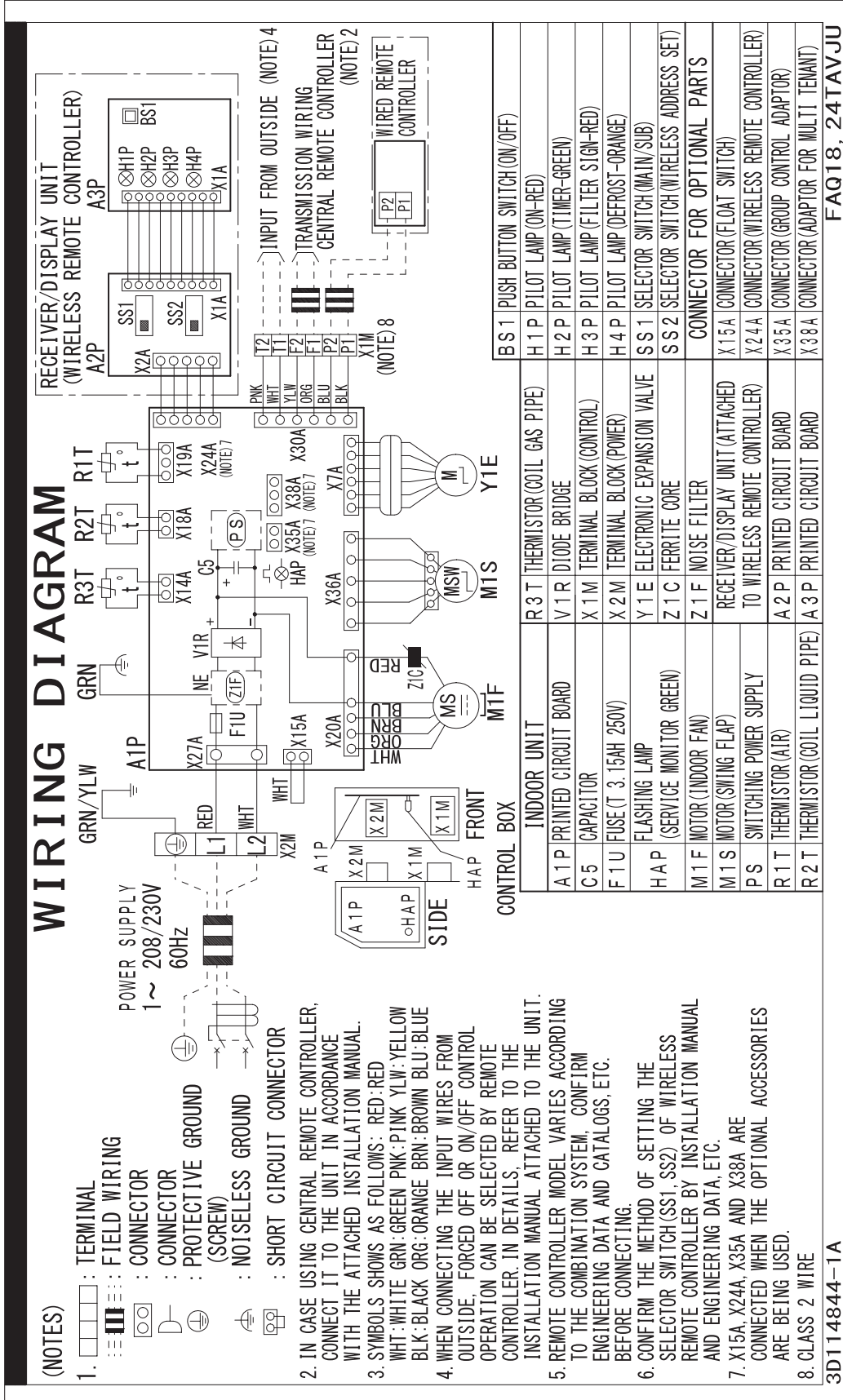

(NOTES)

1. □ : TERMINAL
 □ : FIELD WIRING
 ○ : CONNECTOR
 ○ : CONNECTOR
 ⊕ : PROTECTIVE GROUND (SCREW)
 ⊕ : NOISELESS GROUND
 ⊕ : SHORT CIRCUIT CONNECTOR
2. IN CASE USING CENTRAL REMOTE CONTROLLER, CONNECT IT TO THE UNIT IN ACCORDANCE WITH THE ATTACHED INSTALLATION MANUAL.
3. SYMBOLS SHOWS AS FOLLOWS: RED:RED WHT:WHITE GRN:GREEN PNK:PINK YLW:YELLOW BLK:BLACK ORG:ORANGE BRN:BROWN BLU:BLUE
4. WHEN CONNECTING THE INPUT WIRES FROM OUTSIDE, FORCED OFF OR ON/OFF CONTROL OPERATION CAN BE SELECTED BY REMOTE CONTROLLER. IN DETAILS, REFER TO THE INSTALLATION MANUAL ATTACHED TO THE UNIT.
5. REMOTE CONTROLLER MODEL VARIES ACCORDING TO THE COMBINATION SYSTEM, CONFIRM ENGINEERING DATA AND CATALOGS, ETC. BEFORE CONNECTING.
6. CONFIRM THE METHOD OF SETTING THE SELECTOR SWITCH (SS1, SS2) OF WIRELESS REMOTE CONTROLLER BY INSTALLATION MANUAL AND ENGINEERING DATA, ETC.
7. X15A, X24A, X35A AND X38A ARE CONNECTED WHEN THE OPTIONAL ACCESSORIES ARE BEING USED.
8. CLASS 2 WIRE

INDOOR UNIT	CONTROL BOX	RECEIVER/DISPLAY UNIT (WIRELESS REMOTE CONTROLLER)	CENTRAL REMOTE CONTROLLER (NOTE) 2	WIRED REMOTE CONTROLLER
A 1 P PRINTED CIRCUIT BOARD	A 1 P	A2P	T2	P2
C 5 CAPACITOR	X 2 M	SS1	F2	P1
F 1 U FUSE (T 3.15AH 250V)	X 1 M	SS2	F1	P1
H A P FLASHING LAMP (SERVICE MONITOR GREEN)	H A P FRONT	X1A	T1	
M 1 F MOTOR (INDOOR FAN)	X 2 M	X2A		
M 1 S MOTOR (SWING FLAP)	X 1 M	X19A		
P S SWITCHING POWER SUPPLY	H A P	X18A		
R 1 T THERMISTOR (AIR)	X 1 M	X14A		
R 2 T THERMISTOR (COIL LIQUID PIPE)	X 2 M	X19A		
R 3 T THERMISTOR (COIL GAS PIPE)	X 1 M	X24A		
V 1 R DIODE BRIDGE	X 1 M	X36A		
X 1 M TERMINAL BLOCK (CONTROL)	X 2 M	X35A		
X 2 M TERMINAL BLOCK (POWER)	X 1 M	X38A		
Y 1 E ELECTRONIC EXPANSION VALVE	X 1 M	H A P		
Z 1 C FERRITE CORE	X 1 M	X30A		
Z 1 F NOISE FILTER	X 1 M	X7A		
RECEIVER/DISPLAY UNIT (ATTACHED TO WIRELESS REMOTE CONTROLLER)	X 1 M	X7A		
A 2 P PRINTED CIRCUIT BOARD	X 1 M	X7A		
A 3 P PRINTED CIRCUIT BOARD	X 1 M	X7A		
X 3 8 A CONNECTOR (ADAPTOR FOR MULTI-TENANT)	X 1 M	X7A		

FAQ18, 24TAVJU

C: 3D114844B

FBQ18 - 48TBVJU

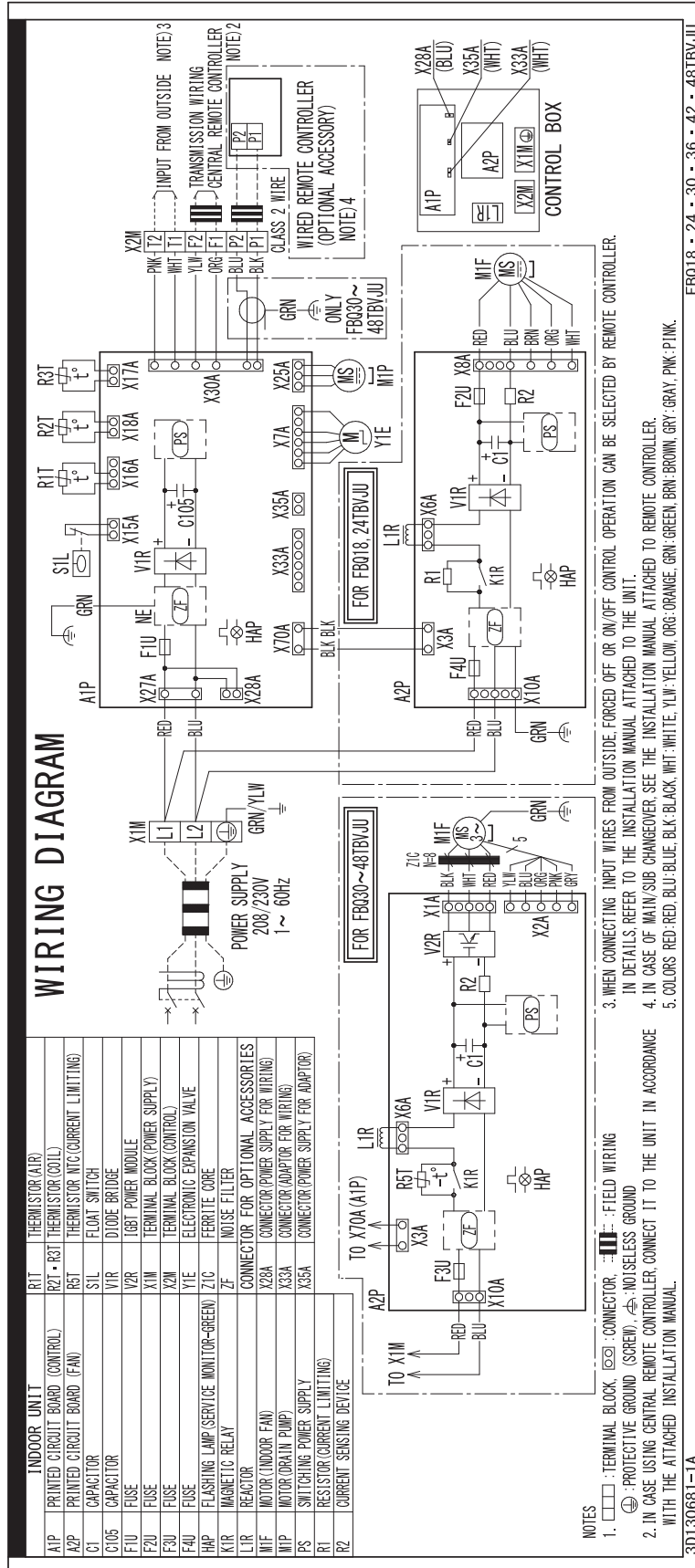

C: 3D130681B

FTQ18 - 48TAVJUD
FTQ18 - 48TAVJUA

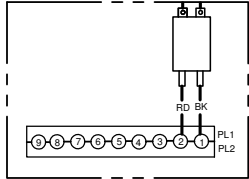
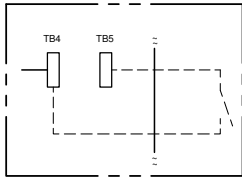
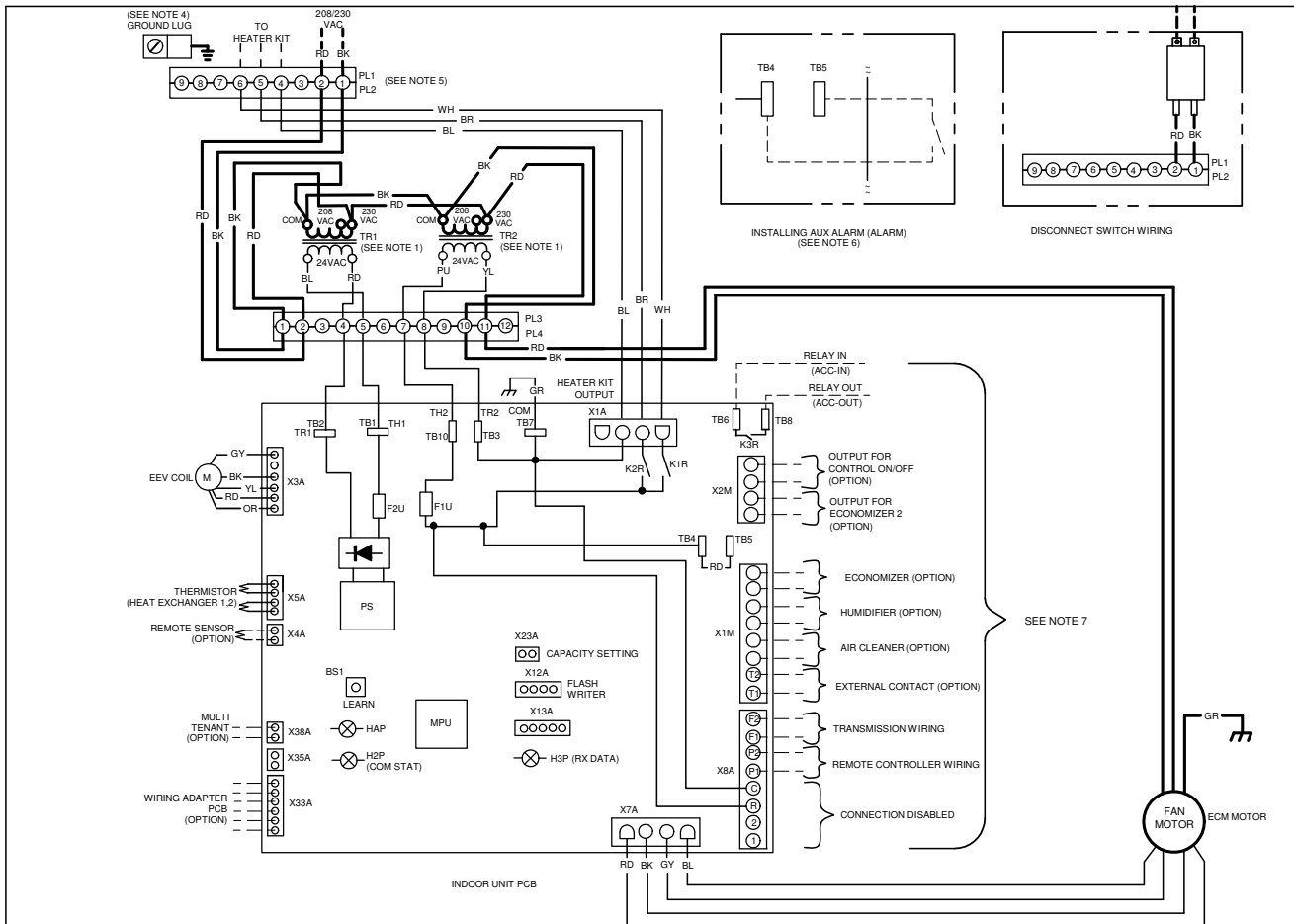

- NOTES:**
- PLACE RED WIRES ON 208 V TERMINAL OF 2-TRANSFORMER (TR1/TR2) FOR 208 VAC OPERATION.
 - MANUFACTURER'S SPECIFIED REPLACEMENT PARTS MUST BE USED WHEN SERVICING.
 - IF ANY OF THE ORIGINAL WIRES AS SUPPLIED WITH THIS UNIT MUST BE REPLACED, IT MUST BE REPLACED WITH WIRING MATERIAL HAVING A TEMPERATURE RATING OF AT LEAST 105°C. USE COPPER CONDUCTORS ONLY.
 - UNIT MUST BE PERMANENTLY GROUNDED AND CONFIRM TO N.E.C AND LOCAL CODES.
 - DISCARD CONNECTOR PL1 WHEN INSTALLING OPTIONAL HEAT KIT.
 - REMOVE SHORT RED CIRCUITING WIRE AND PUT AUX ALARM SWITCH WHEN INSTALLING AUX. ALARM SWITCH.
 - USE N.E.C CLASS 2 WIRE.

- INTEGRATED CONTROL:**
- LOW VOLTAGE ———
 - LOW VOLTAGE FIELD - - -
 - HIGH VOLTAGE ———
 - HIGH VOLTAGE FIELD - - -
 - JUNCTION ●
 - TERMINAL □
 - PLUG CONNECTION □/□
 - EQUIPMENT GND ⚡
 - FIELD GROUND ⊥

- COLOR CODES:**
- BL - BLUE
 - RD - RED
 - YL - YELLOW
 - OR - ORANGE
 - BK - BLACK
 - GY - GREY
 - BR - BROWN
 - GR - GREEN
 - WH - WHITE
 - PU - PURPLE

- COMPONENT CODES:**
- PL1, PL2 — POWER/HEATER KIT/ DISCONNECT SWITCH CONNECTOR
 - TR1, TR2 — TRANSFORMER
 - F1U, F2U — FUSE LINK
 - PL3, PL4 — TRANSFORMER CONNECTOR



0140A00500-B

9.2 Outdoor Unit
RZR18 - 24TBVJUA
RZQ18 - 24TBVJUA

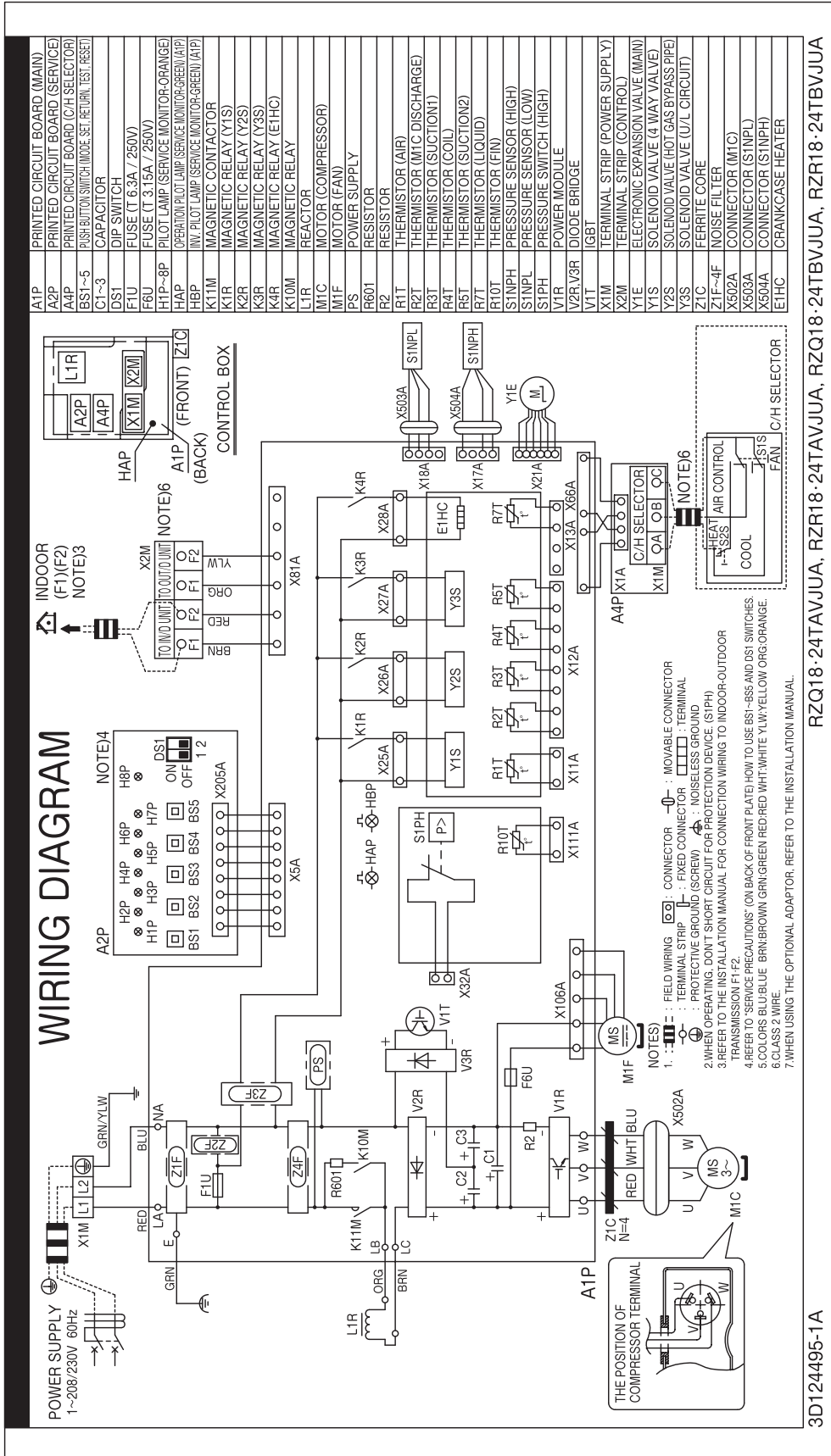

C: 3D124495B

RZR30 - 48TBVJUA
RZQ30 - 48TBVJUA

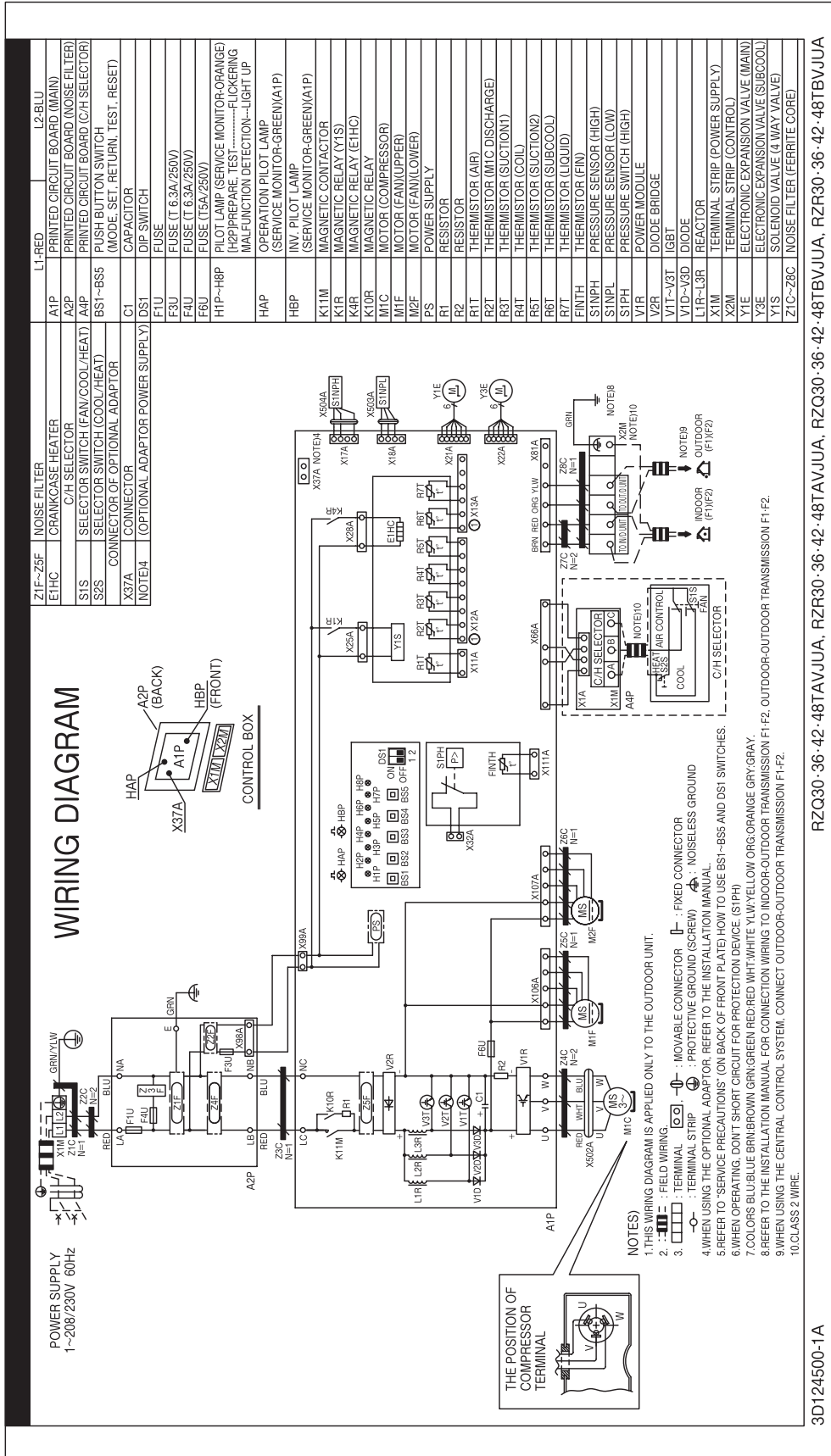

C: 3D124500B

10. Field Wiring

RZR18 - 24TBVJUA RZQ18 - 24TBVJUA

- Notes
- 1) All wiring, components and materials to be procured on the site must comply with the applicable local and national codes.
 - 2) Use copper conductors only.
 - 3) As for details, see wiring diagram.
 - 4) Install circuit breaker for safety.
 - 5) All field wiring and components must be provided by licensed electrician.
 - 6) Unit shall be grounded in compliance with the applicable local and national codes.
 - 7) Wiring shown is general points-of-connection guides only and is not intended for or to include all details for a specific installation.
 - 8) Be sure to install the switch and the fuse/breaker to the power line of each equipment.

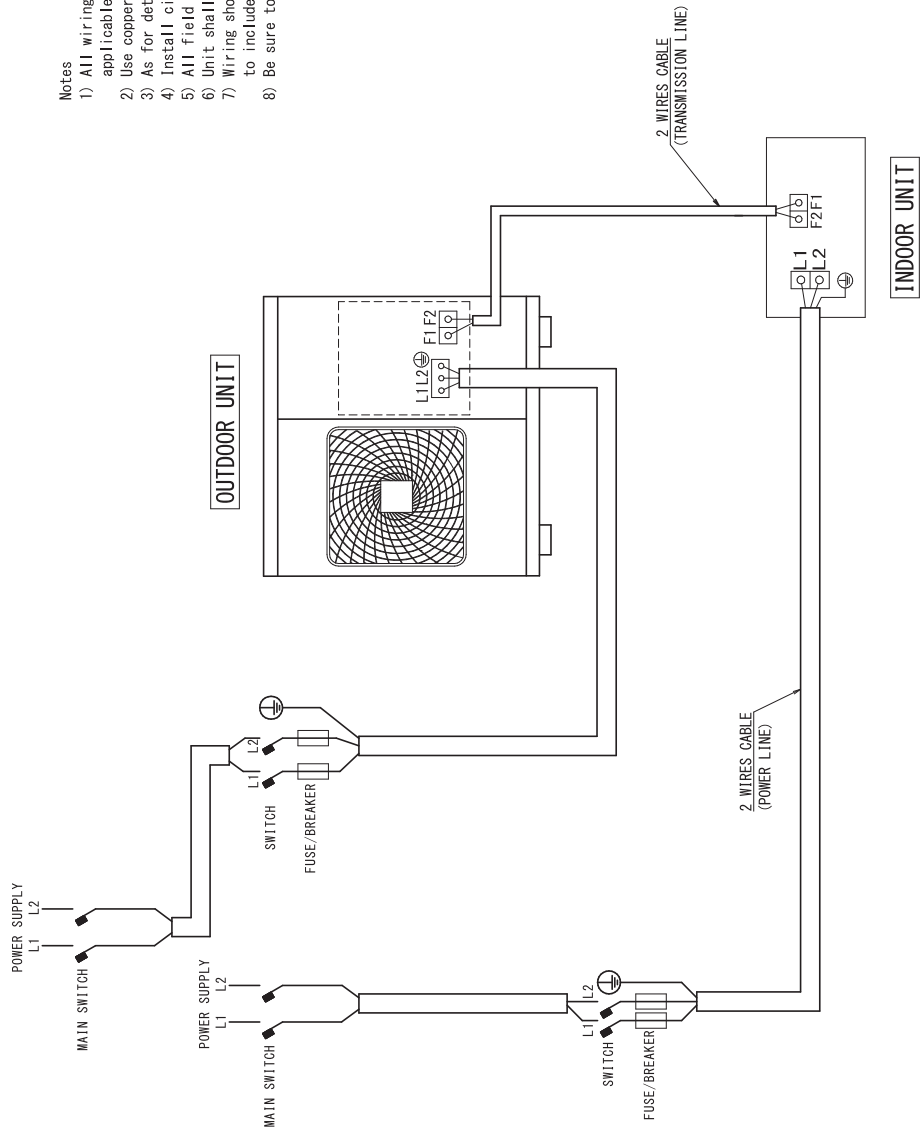

RZR30 - 48TBVJUA
RZQ30 - 48TBVJUA

- Notes
- 1) All wiring, components and materials to be procured on the site must comply with the applicable local and national codes.
 - 2) Use copper conductors only.
 - 3) As for details, see wiring diagram.
 - 4) Install circuit breaker for safety.
 - 5) All field wiring and components must be provided by licensed electrician.
 - 6) Unit shall be grounded in compliance with the applicable local and national codes.
 - 7) Wiring shown is general points-of-connection guides only and is not intended for or to include all details for a specific installation.
 - 8) Be sure to install the switch and the fuse/breaker to the power line of each equipment.

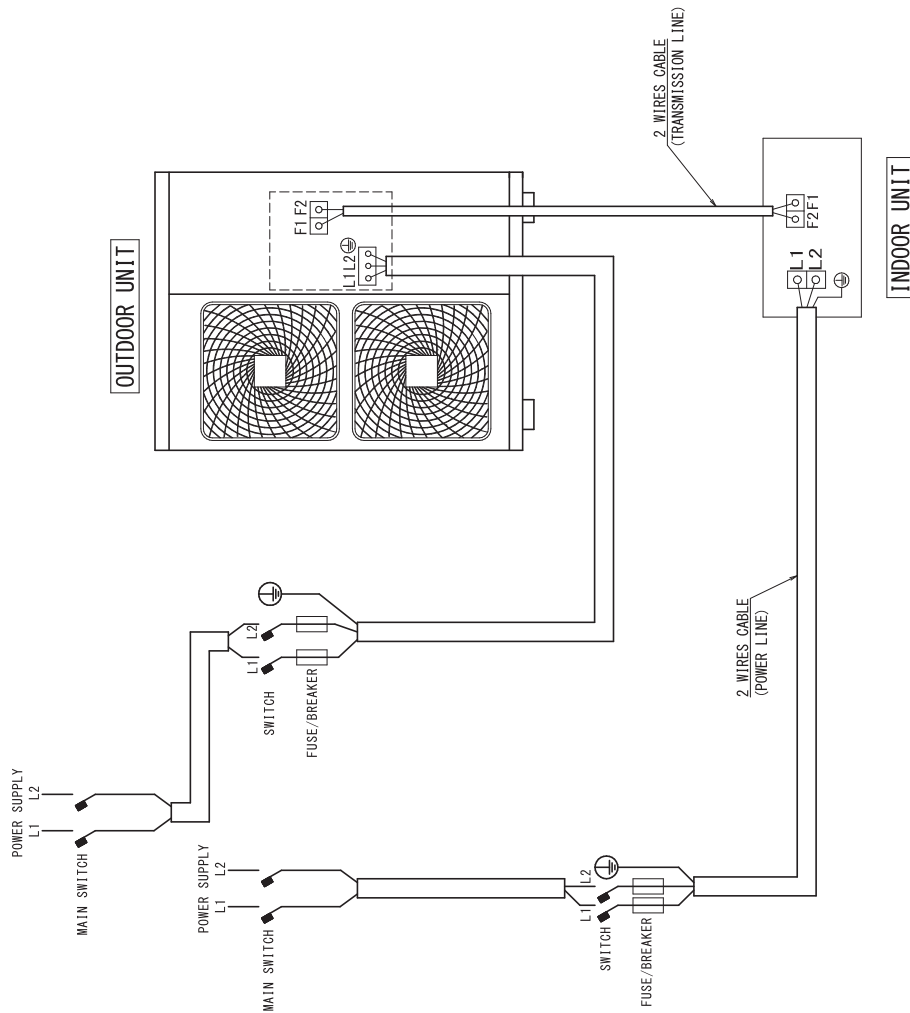

11. Electrical Characteristics

11.1 Indoor Unit

FCQ18 - 48AAVJU

Model	Power supply					IFM		Input (W)		SCCR
	Hz	Volts	Voltage range	MCA	MOP	HP	FLA	Cooling	Heating	
FCQ18AAVJU	60	208/230 V	Max. 253 V Min. 187 V	0.5	15	0.07 (53)	0.4	72	68	SCCR kA rms, Symmetrical @600V MAX:5
FCQ24AAVJU				0.5	15	0.07 (53)	0.4	72	68	
FCQ30AAVJU				1.0	15	0.14 (106)	0.8	128	110	
FCQ36AAVJU				1.6	15	0.14 (106)	1.3	217	207	
FCQ42AAVJU				1.6	15	0.14 (106)	1.3	217	207	
FCQ48AAVJU				1.6	15	0.14 (106)	1.3	217	207	

Symbol:

MCA: Minimum Circuit Ampacity (A)

MOP: Maximum Overcurrent Protective Device (A)

HP: Fan Motor Rated Output (HP (W))

FLA: Full Load Ampere (A)

IFM: Indoor Fan Motor

SCCR: Short-Circuit Current Rating

Note:

1. Voltage range

Units are suitable for use on electrical systems where voltage supplied to unit terminals is not below or above listed range limits.

2. Maximum allowable voltage unbalance between phases is 2%.

3. MCA / MOP

 $MCA = 1.25 \times FLA$
 $MOP \leq 4 \times FLA$

(Next lower standard fuse rating is minimum 15 A.)

4. Select wiring size based on the MCA.

5. Cooling power input value includes power required to operate the built-in drain pump.

C: 4D140938

Model	FCQ18AAVJU	FCQ24AAVJU	FCQ30AAVJU	FCQ36AAVJU	FCQ42AAVJU	FCQ48AAVJU							
Operation mode	Cooling	Heating	Cooling	Heating	Cooling	Heating							
Input power (W)	H	70	66	72	68	128	110	217	207	217	207	217	207
	M	44	42	44	42	89	83	101	91	115	103	115	103
	L	25	24	25	24	51	46	51	46	64	59	64	59

C: 3D140939

FAQ18 - 24TAVJU

Model	Power Supply				IFM		Input (W)		
	Hz	Volts	Voltage range	MCA	MOP	KW	FLA	Cooling	Heating
FAQ18TAVJU	60	208/230 V	Max. 253 V Min. 187 V	0.5	15	0.043	0.4	33	39
FAQ24TAVJU				0.6	15	0.043	0.5	50	60

Symbol:

MCA: Minimum Circuit Ampacity (A)

MOP: Maximum Overcurrent Protective Device (A)

KW: Fan Motor Rated Output (kW)

FLA: Full Load Ampere (A)

IFM: Indoor Fan Motor

Note:

1. Voltage range

Units are suitable for use on electrical systems where voltage supplied to unit terminals is not below or above listed range limits.

2. Maximum allowable voltage unbalance between phases is 2%.

3. MCA / MOP

MCA = 1.25 × FLA

MOP ≤ 4 × FLA

(Next lower standard fuse rating is minimum 15 A.)

4. Select wiring size based on the MCA.

5. Either a fuse or a circuit breaker is acceptable.

C: 4D115411

FBQ18 - 48TBVJU

Model	Power Supply					IFM		Input (W)		SCCR
	Hz	Volts	Voltage range	MCA	MOP	HP	FLA	Cooling	Heating	
FBQ18TBVJU	60	208/230 V	Max. 253 V Min. 187 V	1.9	15	0.31 (230)	1.5	262	256	SCCR kA rms, Symmetrical @600V MAX:5
FBQ24TBVJU				1.9	15	0.31 (230)	1.5	257	251	
FBQ30TBVJU				3.0	15	0.49 (364)	2.4	397	391	
FBQ36TBVJU				3.1	15	0.49 (364)	2.5	401	395	
FBQ42TBVJU				3.6	15	0.49 (364)	2.9	464	458	
FBQ48TBVJU				3.6	15	0.49 (364)	2.9	464	458	

Symbol:

MCA: Minimum Circuit Ampacity (A)
MOP: Maximum Overcurrent Protective Device (A)
HP: Fan Motor Rated Output (Hp (W))
FLA: Full Load Ampere (A)
IFM: Indoor Fan Motor
SCCR: Short-Circuit Current Rating

Note:

- Voltage range
Units are suitable for use on electrical systems where voltage supplied to unit terminals is not below or above listed range limits.
- Maximum allowable voltage unbalance between phases is 2%.
- MCA / MOP
 $MCA = 1.25 \times FLA$
 $MOP \leq 4 \times FLA$
(Next lower standard fuse rating is minimum 15 A.)
- Select wiring size based on the MCA.
- Instead of fuse, use circuit breaker.
- Cooling power input value includes power required to operate the built-in drain pump.

C: 4D140803

FTQ18 - 48TAVJUD
FTQ18 - 48TAVJUA

Model	Power Supply				IFM		Input (W)		
	Hz	Volts	Voltage range	MCA	MOP	HP	FLA	Cooling	Heating
FTQ18TAVJUD	60	208/230 V	Max. 229 V Min. 187 V <hr/> Max. 253 V Min. 209 V	4.9	15	1/2	3.9	215	215
FTQ24TAVJUD	60	208/230 V		4.9	15	1/2	3.9	273	273
FTQ30TAVJUD	60	208/230 V		4.9	15	1/2	3.9	407	407
FTQ36TAVJUD	60	208/230 V		4.9	15	1/2	3.9	436	436
FTQ42TAVJUD	60	208/230 V		6.5	15	3/4	5.2	473	473
FTQ48TAVJUD	60	208/230 V		6.5	15	3/4	5.2	518	518
FTQ18TAVJUA	60	208/230 V	Max. 229 V Min. 187 V <hr/> Max. 253 V Min. 209 V	4.9	15	1/2	3.9	215	215
FTQ24TAVJUA	60	208/230 V		4.9	15	1/2	3.9	273	273
FTQ30TAVJUA	60	208/230 V		4.9	15	1/2	3.9	407	407
FTQ36TAVJUA	60	208/230 V		4.9	15	1/2	3.9	436	436
FTQ42TAVJUA	60	208/230 V		6.5	15	3/4	5.2	473	473
FTQ48TAVJUA	60	208/230 V		6.5	15	3/4	5.2	518	518

Symbol:

MCA : Minimum Circuit Ampacity (A)

MOP : Maximum Overcurrent Protective Device (A)

IFM : Indoor Fan Motor

HP : Fan Motor Rated Output (HP)

FLA : Full Load Ampere (A)

Note:

1. Voltage range

Units are suitable for use on electrical systems where voltage supplied to unit terminals is not below or above listed range limits.

2. Maximum allowable voltage imbalance between phases is 2%.

3. Select wiring size based on the MCA.

11.2 Electric Heater

FTQ18 - 36TAVJUD

FTQ18 - 36TAVJUA

Model	CIRCUIT 1			CIRCUIT 2			SINGLE-POINT KIT	
	AMPS	MCA	MOP	AMPS	MCA	MOP	MCA	MOP
FTQ18TAVJUD FTQ18TAVJUA	0/0	4.9/4.9	15/15	—	—	—	—	—
HKS*03XC*	10.8/12.5	18.4/21	20/25	—	—	—	—	—
HKS*05XC*	17.3/20	27/29.9	30/30	—	—	—	—	—
HKS*06XC*	21.7/25	32/36.1	35/40	—	—	—	—	—
HKS*08XC*	28.9/33.3	41/46.5	45/50	—	—	—	—	—
HKS*10XC*	34.7/40	48/54.9	50/60	—	—	—	—	—
FTQ24TAVJUD FTQ24TAVJUA	0/0	4.9/4.9	15/15	—	—	—	—	—
HKS*03XC*	10.8/12.5	18.4/21	20/25	—	—	—	—	—
HKS*05XC*	17.3/20	27/29.9	30/30	—	—	—	—	—
HKS*06XC*	21.7/25	32/36.1	35/40	—	—	—	—	—
HKS*08XC*	28.9/33.3	41/46.5	45/50	—	—	—	—	—
HKS*10XC*	34.7/40	48/54.9	50/60	—	—	—	—	—
FTQ30TAVJUD FTQ30TAVJUA	0/0	4.9/4.9	15/15	—	—	—	—	—
HKS*03XC*	10.8/12.5	18.4/21	20/25	—	—	—	—	—
HKS*05XC*	17.3/20	27/29.9	30/30	—	—	—	—	—
HKS*06XC*	21.7/25	32/36.1	35/40	—	—	—	—	—
HKS*08XC*	28.9/33.3	41/46.5	45/50	—	—	—	—	—
HKS*10XC*	34.7/40	48/54.9	50/60	—	—	—	—	—
FTQ36TAVJUD FTQ36TAVJUA	0/0	4.9/4.9	15/15	—	—	—	—	—
HKS*03XC*	10.8/12.5	18.4/21	20/25	—	—	—	—	—
HKS*05XC*	17.3/20	27/29.9	30/30	—	—	—	—	—
HKS*06XC*	21.7/25	32/36.1	35/40	—	—	—	—	—
HKS*08XC*	28.9/33.3	41/46.5	45/50	—	—	—	—	—
HKS*10XC*	34.7/40	48/54.9	50/60	—	—	—	—	—

Note:

1. AMPS indicates heater amp draw.
2. Circuit 1 indicates single point power connection requirements when using a single stage electric heater. Circuit 1 powers both the FTQ printed circuit board as well as the 1st stage of heat.
3. Circuit 2 indicates the power requirements for a second power point connection when using a two stage heater (15 kW and above).
4. Consult installation manual when using electric heater with FTQ18 - 36TAVJUD models.

FTQ42 - 48TAVJUD**FTQ42 - 48TAVJUA**

Model	CIRCUIT 1			CIRCUIT 2			SINGLE-POINT KIT	
	AMPS	MCA	MOP	AMPS	MCA	MOP	MCA	MOP
FTQ42TAVJUD FTQ42TAVJUA	0/0	6.5/6.5	15/15	—	—	—	—	—
HKS*05XC*	17.3/20	28.2/32	30/35	—	—	—	—	—
HKS*06XC*	21.7/25	33.6/38	35/40	—	—	—	—	—
HKS*08XC*	28.9/33.3	42.6/48	45/50	—	—	—	—	—
HKS*10XC*	34.7/40	49.8/57	50/60	—	—	—	—	—
HKS*15*#*	34.7/40	49.8/57	50/60	17.3/20	21.7/25	25/25	71.5/81.5	80/90
HKSC19C*#*	34.7/40	49.8/57	50/60	34.7/40	43.3/50	45/50	93.2/106.5	100/110
FTQ48TAVJUD FTQ48TAVJUA	0/0	6.5/6.5	15/15	—	—	—	—	—
HKS*05XC*	17.3/20	28.2/32	30/35	—	—	—	—	—
HKS*06XC*	21.7/25	33.6/38	35/40	—	—	—	—	—
HKS*08XC*	28.9/33.3	42.6/48	45/50	—	—	—	—	—
HKS*10XC*	34.7/40	49.8/57	50/60	—	—	—	—	—
HKS*15*#*	34.7/40	49.8/57	50/60	17.3/20	21.7/25	25/25	71.5/81.5	80/90
HKSC19C*#*	34.7/40	49.8/57	50/60	34.7/40	43.3/50	45/50	93.2/106.5	100/110

Note:

1. AMPS indicates heater amp draw.
2. Circuit 1 indicates single point power connection requirements when using a single stage electric heater. Circuit 1 powers both the FTQ printed circuit board as well as the 1st stage of heat.
3. Circuit 2 indicates the power requirements for a second power point connection when using a two stage heater (15 kW and above).
4. Consult installation manual when using electric heater with FTQ42 - 48TAVJUD models.

11.3 Outdoor Unit

RZR18 - 48TBVJUA

RZQ18 - 48TBVJUA

Model		Units				Power supply		Comp.	OFM	
		Hz	Volts	Min.	Max.	MCA	MOP	RLA	KW	FLA
RZQ18TBVJUA	H/P	60	208/230	187	253	16.5	20	15.3	0.2	0.6
RZQ24TBVJUA										
RZR18TBVJUA	C/O									
RZR24TBVJUA										
RZQ30TBVJUA	H/P	60	208/230	187	253	29.1	35	19.0	0.070 + 0.070	0.3 + 0.3
RZQ36TBVJUA										
RZQ42TBVJUA										
RZQ48TBVJUA										
RZR30TBVJUA	C/O									
RZR36TBVJUA										
RZR42TBVJUA										
RZR48TBVJUA										

Symbol:

MCA: Minimum Circuit Ampacity (A)

MOP: Maximum Overcurrent Protective Device (See note 7) (A)

RLA: Rated Load Ampere (A)

OFM: Outdoor Fan Motor (A)

FLA: Full Load Ampere (A)

KW: Fan Motor Rated Output (kW)

Note:

1. RLA is based on the following conditions.

Power supply: 60 Hz 208/230 V

Cooling

Indoor temp. 80.0°FDB (26.7°CDB) / 67.0°FWB (19.4°CWB)

Outdoor temp. 95.0°FDB (35.0°CDB)

Heating

Indoor temp. 70.0°FDB (21.1°CDB)

Outdoor temp. 47.0°FDB (8.3°CDB) / 43.0°FWB (6.1°CWB)

2. Voltage range

Units are suitable for use on electrical systems where voltage supplied to unit terminal is not below or above listed range limits.

3. Maximum allowable voltage variation between phases is 2%.

4. MCA represents maximum input current.

5. MOP represents capacity which may accept MCA.

6. Select wiring size based on the MCA.

7. MOP is used to select a fuse, circuit breaker, or ground fault circuit interrupter.

C: 3D143221A

12. Operation Limits

RZR18 - 48TBVJUA
RZQ18 - 48TBVJUA

Cooling

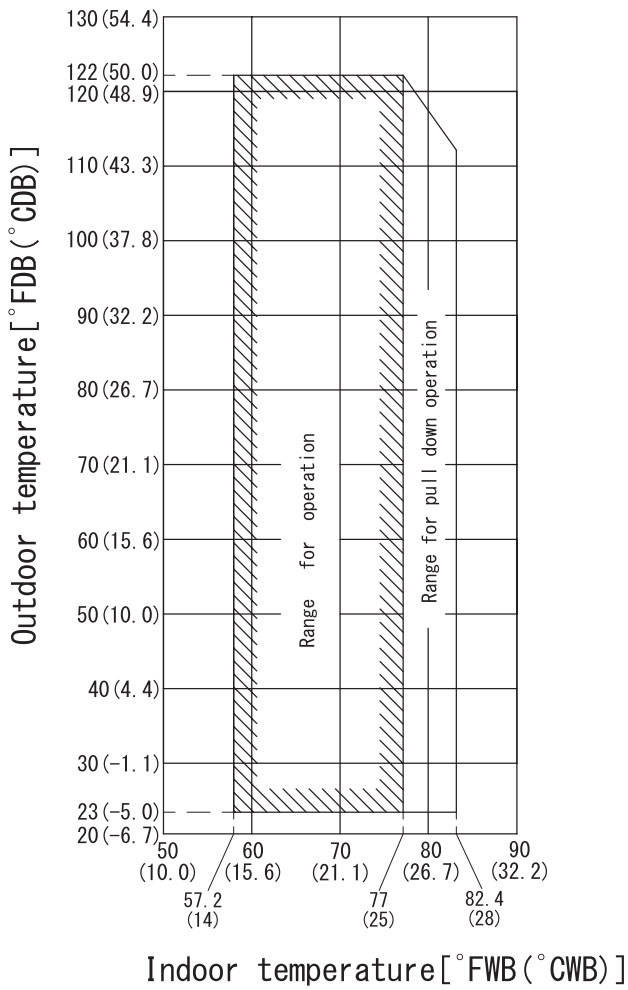

Heating

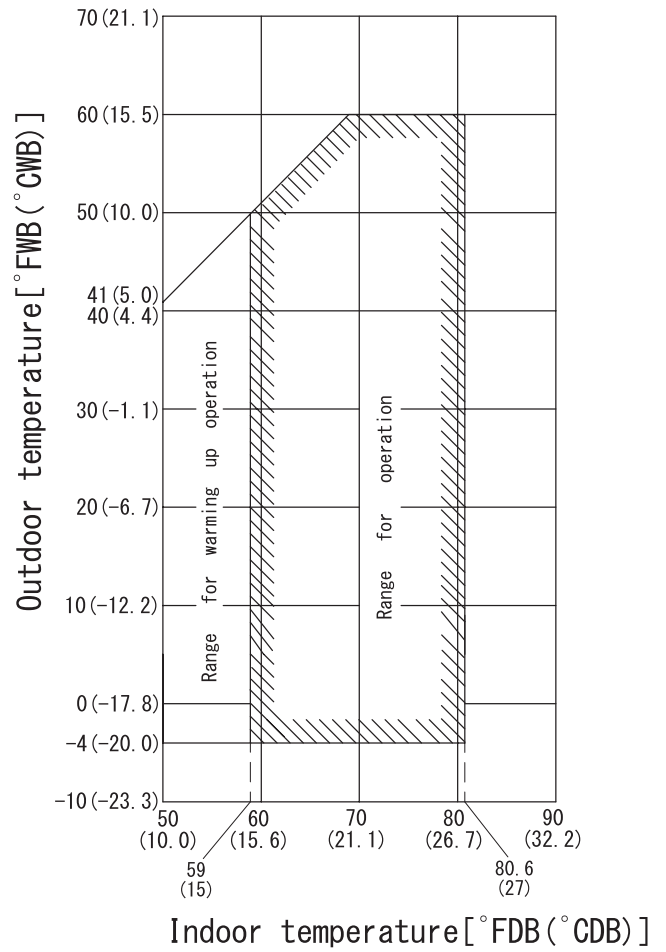

13. Sound Levels (Reference Data)

13.1 Indoor Unit

13.1.1 FCQ

FCQ18 - 24AAVJU

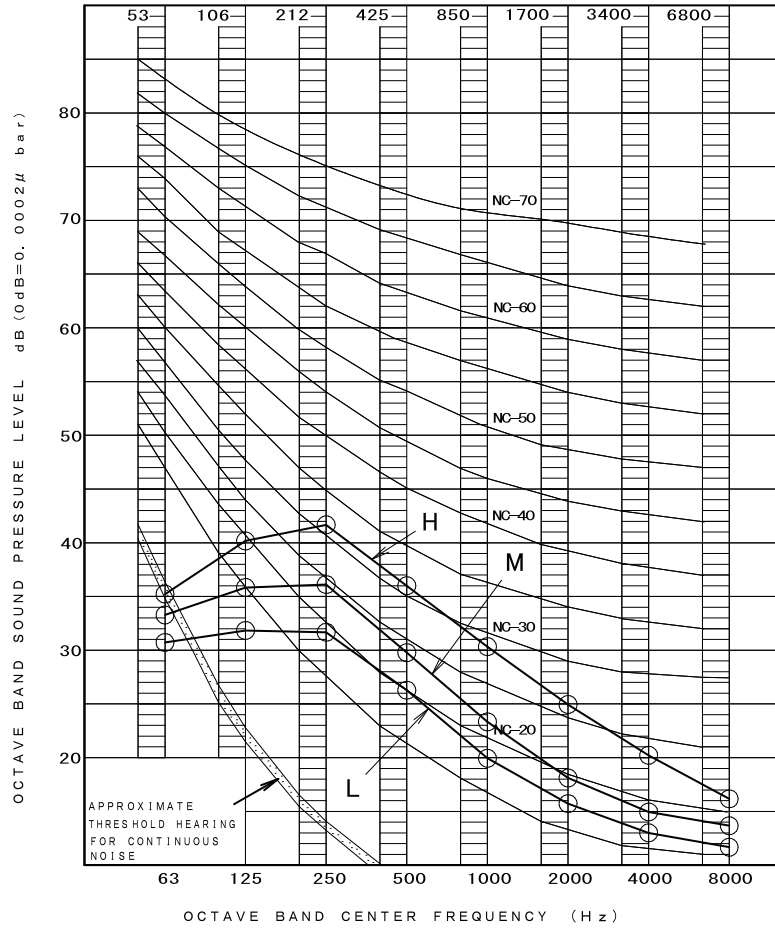

OVER ALL (dB)

SCALE	H	M	L
A	38.0	32.0	28.0

(B. G. N IS ALREADY RECTIFIED)

OPERATING CONDITIONS

POWER SOURCE 208/230V 60Hz

COOLING RETURN AIR TEMPERATURE: 80.0°F (26.7°C) DB, 67.0°F (19.4°C) WB

OUTDOOR TEMPERATURE: 95.0°F (35.0°C) DB, 75.0°F (23.9°C) WB

HEATING RETURN AIR TEMPERATURE: 70.0°F (21.1°C) DB, 60.0°F (15.6°C) WB

OUTDOOR TEMPERATURE: 47.0°F (8.3°C) DB, 43.0°F (6.1°C) WB

LOCATION OF MICROPHONE

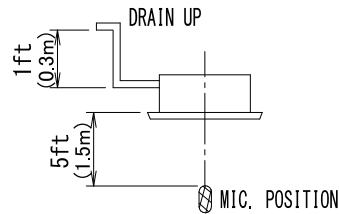

MEASURING PLACE

ANECHOIC CHAMBER

NOTE: OPERATION NOISE DIFFERS WITH OPERATION AND AMBIENT CONDITIONS.

FCQ30AAVJU

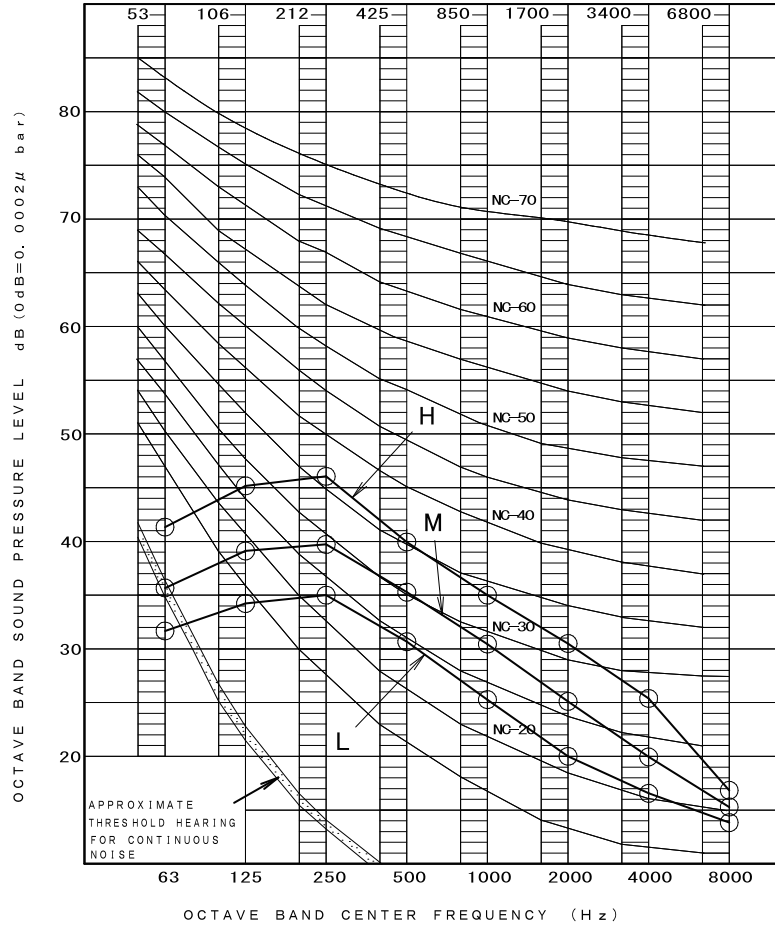

OVER ALL (dB)

SCALE	H	M	L
A	42.0	37.0	32.0

(B. G. N IS ALREADY RECTIFIED)

OPERATING CONDITIONS

POWER SOURCE 208/230V 60Hz

COOLING RETURN AIR TEMPERATURE: 80.0°F (26.7°C) DB, 67.0°F (19.4°C) WB

OUTDOOR TEMPERATURE: 95.0°F (35.0°C) DB, 75.0°F (23.9°C) WB

HEATING RETURN AIR TEMPERATURE: 70.0°F (21.1°C) DB, 60.0°F (15.6°C) WB

OUTDOOR TEMPERATURE: 47.0°F (8.3°C) DB, 43.0°F (6.1°C) WB

LOCATION OF MICROPHONE

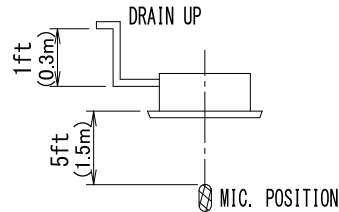

MEASURING PLACE

ANECHOIC CHAMBER

NOTE: OPERATION NOISE DIFFERS WITH OPERATION AND AMBIENT CONDITIONS.

FCQ36AAVJU

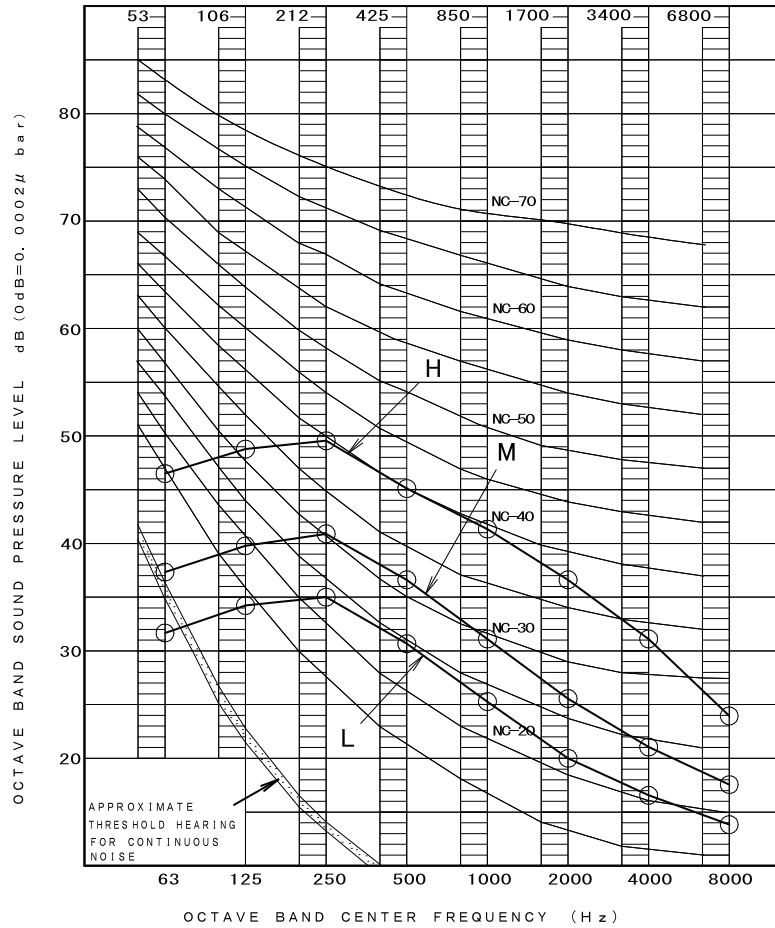

OVER ALL (dB)

SCALE	H	M	L
A	47.0	38.0	32.0

(B. G. N IS ALREADY RECTIFIED)

OPERATING CONDITIONS

POWER SOURCE 208/230V 60Hz

COOLING RETURN AIR TEMPERATURE: 80.0°F (26.7°C) DB, 67.0°F (19.4°C) WB

OUTDOOR TEMPERATURE: 95.0°F (35.0°C) DB, 75.0°F (23.9°C) WB

HEATING RETURN AIR TEMPERATURE: 70.0°F (21.1°C) DB, 60.0°F (15.6°C) WB

OUTDOOR TEMPERATURE: 47.0°F (8.3°C) DB, 43.0°F (6.1°C) WB

LOCATION OF MICROPHONE

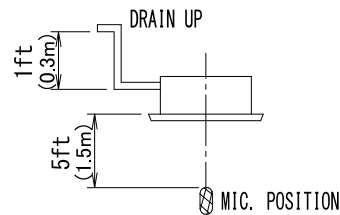

MEASURING PLACE

ANECHOIC CHAMBER

NOTE: OPERATION NOISE DIFFERS WITH OPERATION AND AMBIENT CONDITIONS.

FCQ42 - 48AAVJU

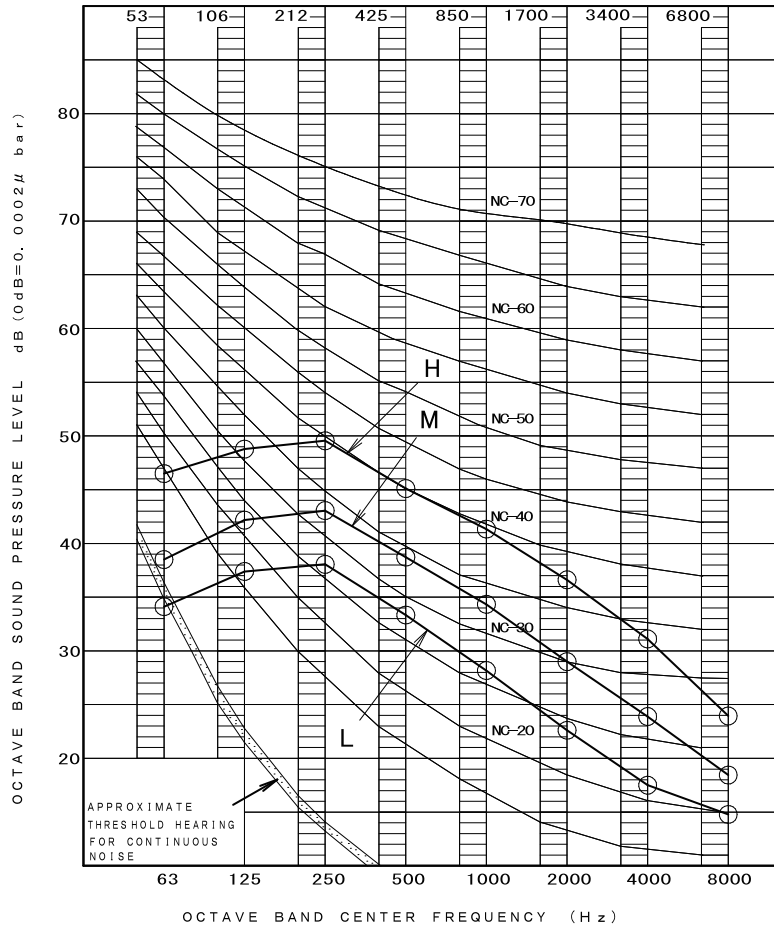

OVER ALL (dB)

SCALE	H	M	L
A	47.0	40.0	35.0

(B. G. N IS ALREADY RECTIFIED)

OPERATING CONDITIONS

POWER SOURCE 208/230V 60Hz

COOLING RETURN AIR TEMPERATURE: 80.0°F (26.7°C) DB, 67.0°F (19.4°C) WB

OUTDOOR TEMPERATURE: 95.0°F (35.0°C) DB, 75.0°F (23.9°C) WB

HEATING RETURN AIR TEMPERATURE: 70.0°F (21.1°C) DB, 60.0°F (15.6°C) WB

OUTDOOR TEMPERATURE: 47.0°F (8.3°C) DB, 43.0°F (6.1°C) WB

LOCATION OF MICROPHONE

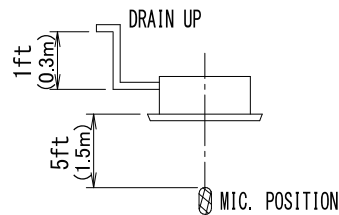

MEASURING PLACE

ANECHOIC CHAMBER

NOTE: OPERATION NOISE DIFFERS WITH OPERATION AND AMBIENT CONDITIONS.

13.1.2 FAQ
FAQ18TAVJU

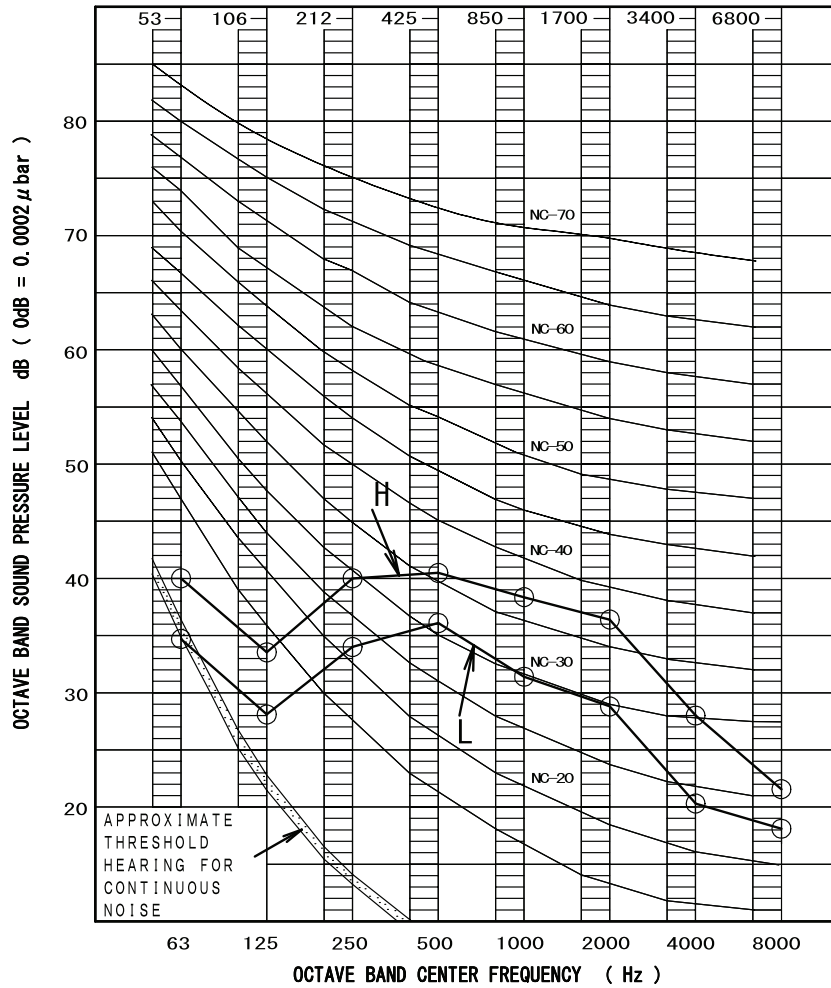

OVER ALL (dB)

SCALE	M O D E	
	H	L
A	43.0	37.0

(B. G. N IS ALREADY RECTIFIED)

OPERATING CONDITIONS

POWER SOURCE 208/230V, 60Hz

STANDARD CONDITION (JIS)

LOCATION OF MICROPHONE

MEASURING PLACE

MEASURE IN ANECHOIC ROOM

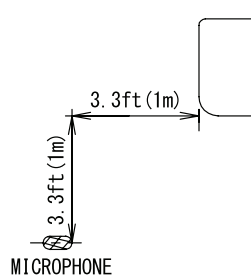

NOTE: Operation noise differs with operation and ambient conditions.

FAQ24TAVJU

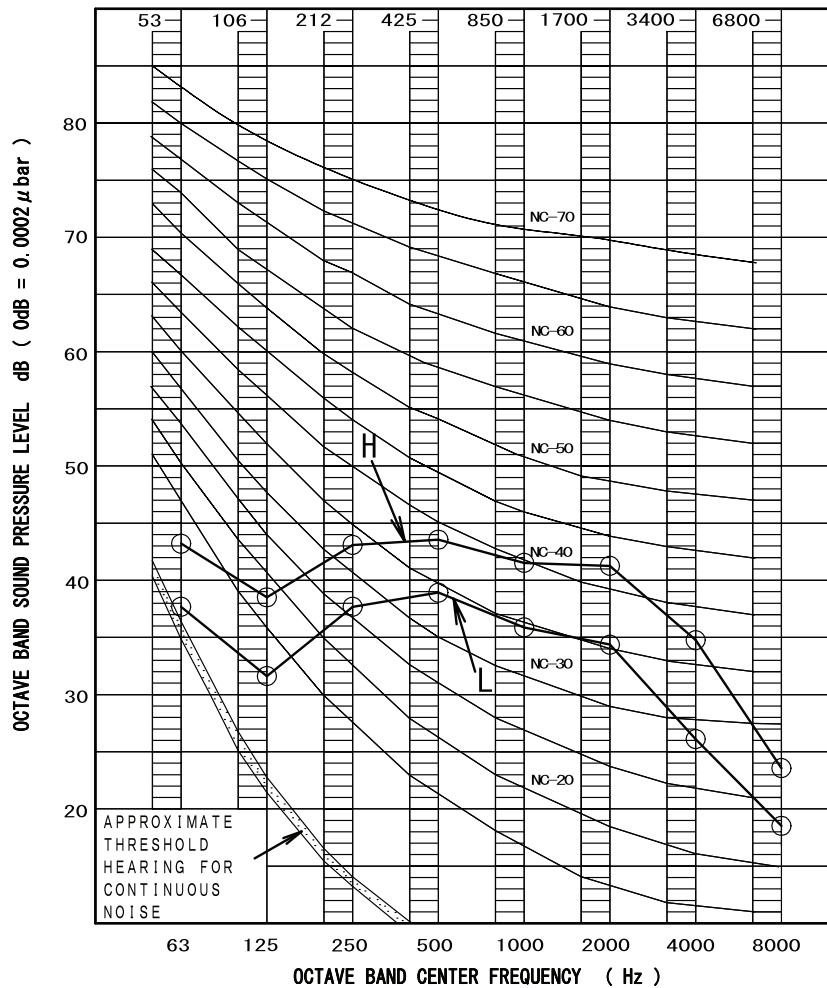

OVER ALL (dB)

SCALE	M O D E	
	H	L
A	47.0	41.0

(B. G. N IS ALREADY RECTIFIED)

OPERATING CONDITIONS

POWER SOURCE 208/230V, 60Hz

STANDARD CONDITION (JIS)

LOCATION OF MICROPHONE

MEASURING PLACE

MEASURE IN ANECHOIC ROOM

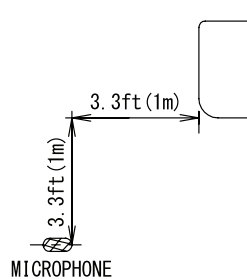

NOTE: Operation noise differs with operation and ambient conditions.

13.1.3 FBQ
FBQ18TBVJU

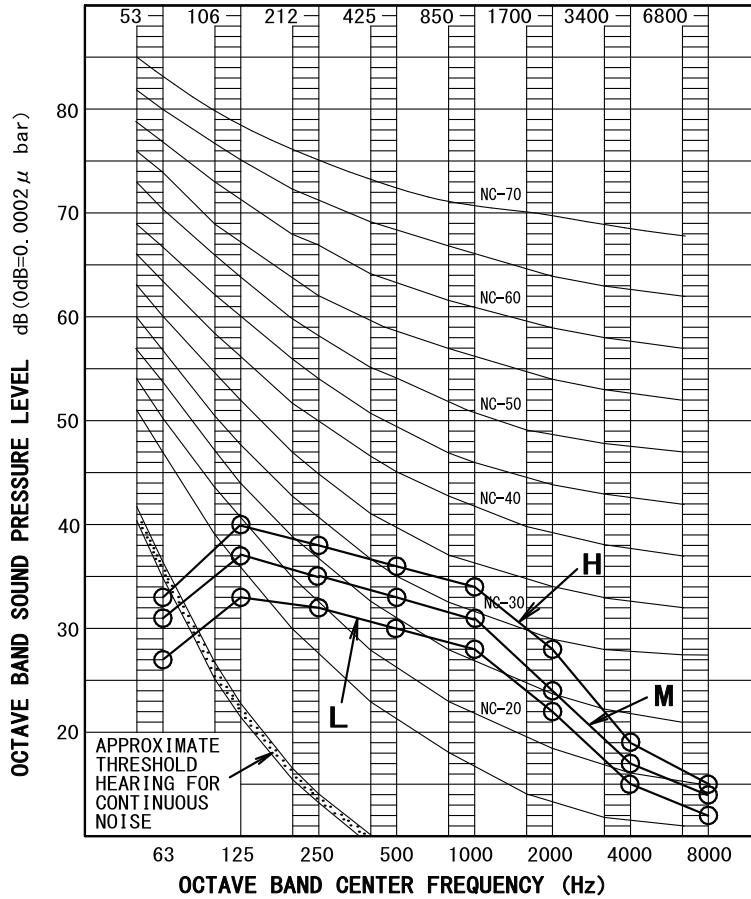

OVER ALL (dB)

OPERATING CONDITIONS

SCALE	AIRFLOW RATE		
	H	M	L
A	38.0	35.0	32.0

(B. G. N IS ALREADY RECTIFIED)

MEASURING PLACE

ANECHOIC CHAMBER

POWER SOURCE	208 / 230V 60Hz
COOLING	RETURN AIR TEMPERATURE: 80.0° F (26.7°C) DB, 67.0° F (19.4°C) WB OUTDOOR TEMPERATURE : 95.0° F (35.0°C) DB, 75.0° F (23.9°C) WB
HEATING	RETURN AIR TEMPERATURE: 70.0° F (21.1°C) DB, 60.0° F (15.6°C) WB OUTDOOR TEMPERATURE : 47.0° F (8.3°C) DB, 43.0° F (6.1°C) WB
EXTERNAL STATIC PRESSURE	0.4 in. WG (100Pa)

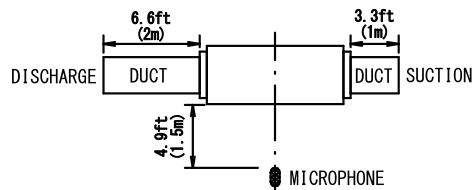

NOTE: OPERATION NOISE DIFFERS WITH OPERATION AND AMBIENT CONDITIONS.

FBQ24TBVJU

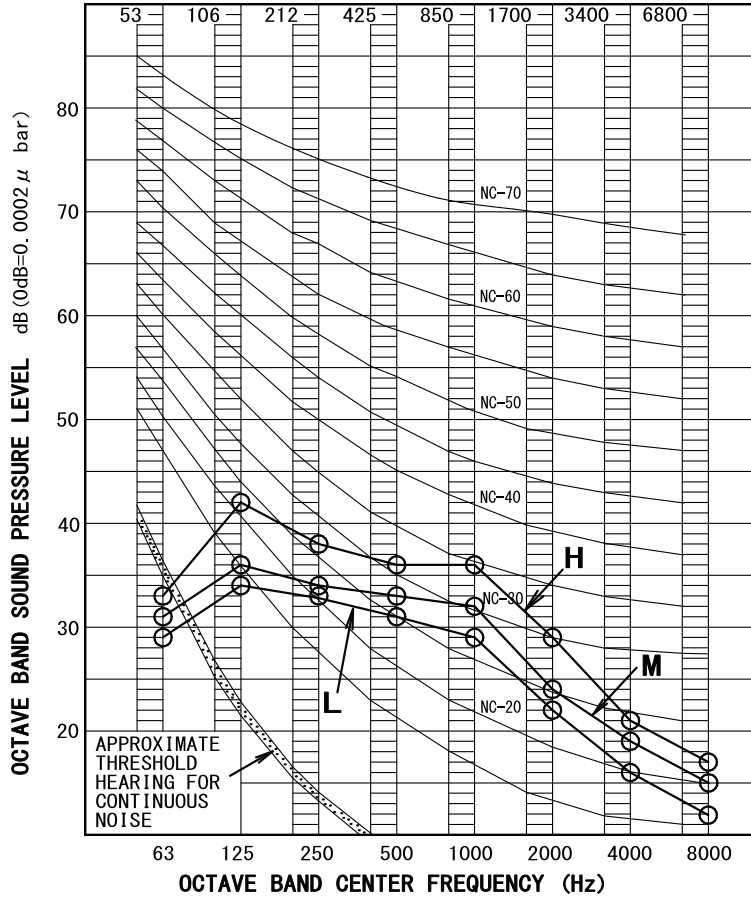

OVER ALL (dB)

OPERATING CONDITIONS

SCALE	AIRFLOW RATE		
	H	M	L
A	39.0	35.0	33.0

(B. G. N IS ALREADY RECTIFIED)

MEASURING PLACE

ANECHOIC CHAMBER

POWER SOURCE 208 / 230V 60Hz

COOLING

RETURN AIR TEMPERATURE: 80.0° F (26.7°C) DB, 67.0° F (19.4°C) WB
 OUTDOOR TEMPERATURE : 95.0° F (35.0°C) DB, 75.0° F (23.9°C) WB

HEATING

RETURN AIR TEMPERATURE: 70.0° F (21.1°C) DB, 60.0° F (15.6°C) WB
 OUTDOOR TEMPERATURE : 47.0° F (8.3°C) DB, 43.0° F (6.1°C) WB

EXTERNAL STATIC PRESSURE 0.4 in. WG (100Pa)

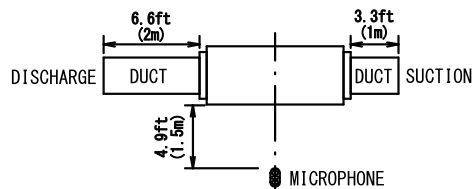

NOTE: OPERATION NOISE DIFFERS WITH OPERATION AND AMBIENT CONDITIONS.

FBQ30TBVJU

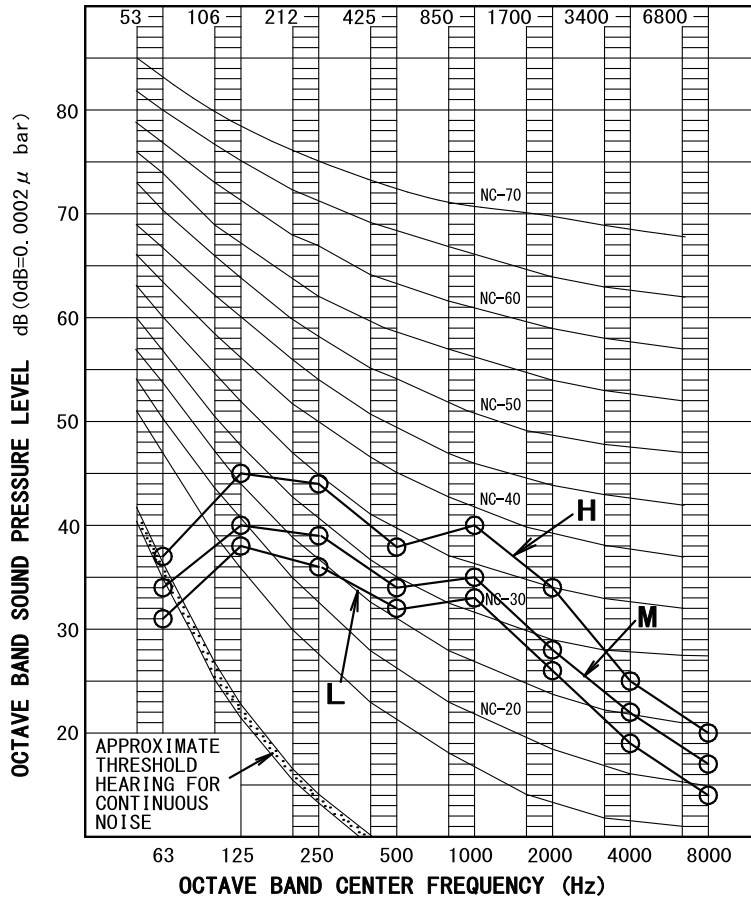

OVER ALL (dB)

OPERATING CONDITIONS

SCALE	AIRFLOW RATE		
	H	M	L
A	43.0	38.0	36.0

(B. G. N IS ALREADY RECTIFIED)

MEASURING PLACE

ANECHOIC CHAMBER

POWER SOURCE	208 / 230V 60Hz
COOLING	RETURN AIR TEMPERATURE: 80.0° F (26.7°C) DB, 67.0° F (19.4°C) WB OUTDOOR TEMPERATURE : 95.0° F (35.0°C) DB, 75.0° F (23.9°C) WB
HEATING	RETURN AIR TEMPERATURE: 70.0° F (21.1°C) DB, 60.0° F (15.6°C) WB OUTDOOR TEMPERATURE : 47.0° F (8.3°C) DB, 43.0° F (6.1°C) WB
EXTERNAL STATIC PRESSURE	0.4 in. WG (100Pa)

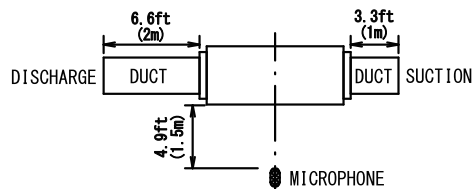

NOTE: OPERATION NOISE DIFFERS WITH OPERATION AND AMBIENT CONDITIONS.

FBQ36TBVJU

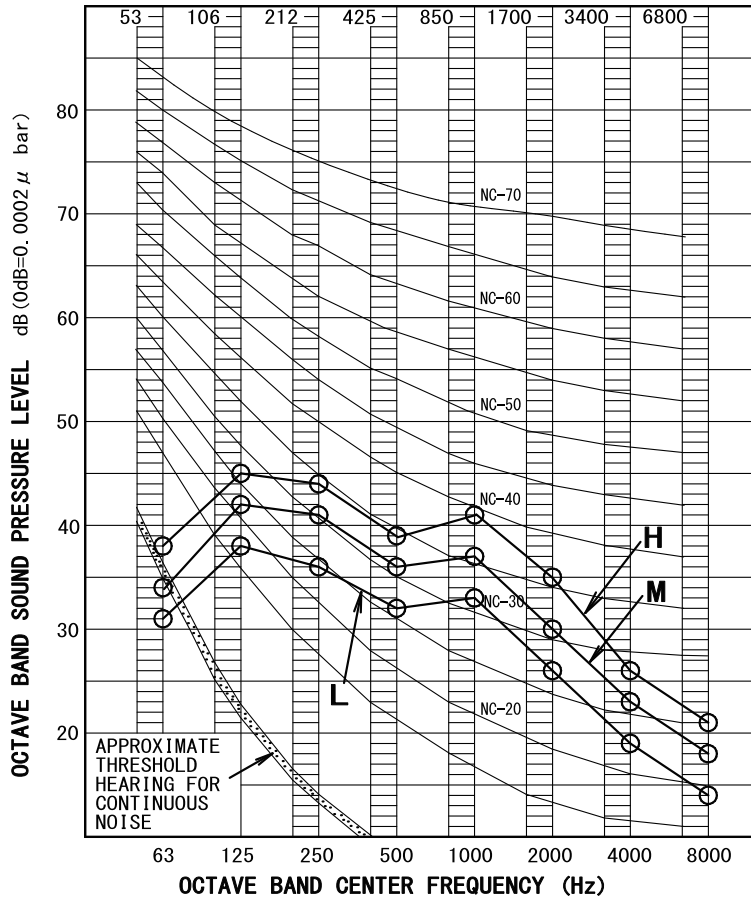

OVER ALL (dB)

OPERATING CONDITIONS

SCALE	AIRFLOW RATE		
	H	M	L
A	44.0	40.0	36.0

(B. G. N IS ALREADY RECTIFIED)

MEASURING PLACE

ANECHOIC CHAMBER

POWER SOURCE 208 / 230V 60Hz

COOLING

RETURN AIR TEMPERATURE: 80.0° F (26.7°C) DB, 67.0° F (19.4°C) WB
 OUTDOOR TEMPERATURE : 95.0° F (35.0°C) DB, 75.0° F (23.9°C) WB

HEATING

RETURN AIR TEMPERATURE: 70.0° F (21.1°C) DB, 60.0° F (15.6°C) WB
 OUTDOOR TEMPERATURE : 47.0° F (8.3°C) DB, 43.0° F (6.1°C) WB

EXTERNAL STATIC PRESSURE 0.4 in. WG (100Pa)

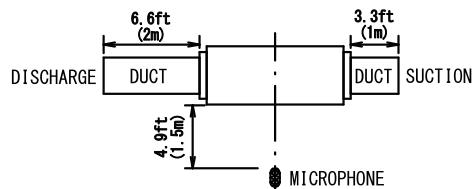

NOTE: OPERATION NOISE DIFFERS WITH OPERATION AND AMBIENT CONDITIONS.

FBQ42TBVJU

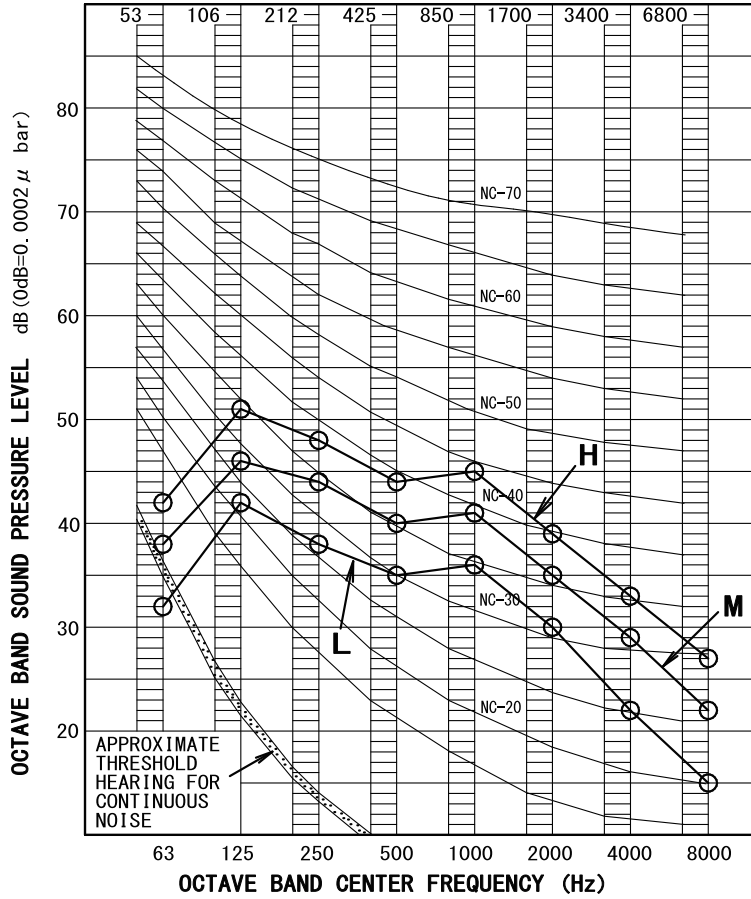

OVER ALL (dB)

OPERATING CONDITIONS

SCALE	AIRFLOW RATE		
	H	M	L
A	48.0	44.0	39.0

(B. G. N IS ALREADY RECTIFIED)

MEASURING PLACE

ANECHOIC CHAMBER

POWER SOURCE	208 / 230V 60Hz
COOLING	RETURN AIR TEMPERATURE: 80.0° F (26.7°C) DB, 67.0° F (19.4°C) WB OUTDOOR TEMPERATURE : 95.0° F (35.0°C) DB, 75.0° F (23.9°C) WB
HEATING	RETURN AIR TEMPERATURE: 70.0° F (21.1°C) DB, 60.0° F (15.6°C) WB OUTDOOR TEMPERATURE : 47.0° F (8.3°C) DB, 43.0° F (6.1°C) WB
EXTERNAL STATIC PRESSURE	0.4 in. WG (100Pa)

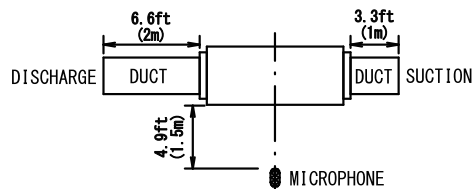

NOTE: OPERATION NOISE DIFFERS WITH OPERATION AND AMBIENT CONDITIONS.

FBQ48TBVJU

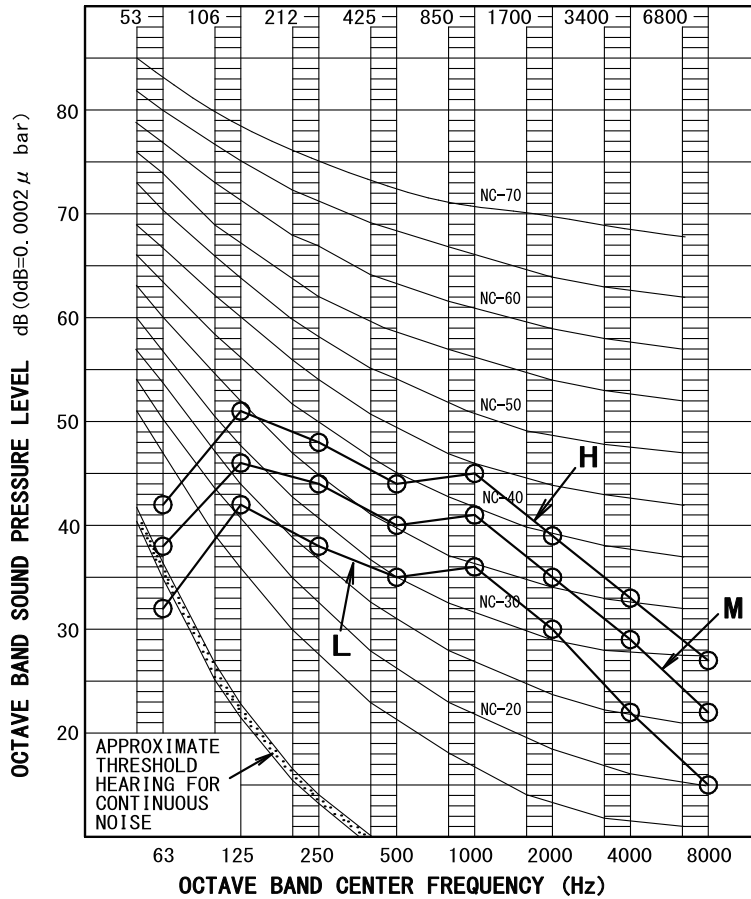

OVER ALL (dB)

OPERATING CONDITIONS

SCALE	AIRFLOW RATE		
	H	M	L
A	48.0	44.0	39.0

(B. G. N IS ALREADY RECTIFIED)

MEASURING PLACE

ANECHOIC CHAMBER

POWER SOURCE 208 / 230V 60Hz

COOLING

RETURN AIR TEMPERATURE: 80.0° F (26.7°C) DB, 67.0° F (19.4°C) WB

OUTDOOR TEMPERATURE : 95.0° F (35.0°C) DB, 75.0° F (23.9°C) WB

HEATING

RETURN AIR TEMPERATURE: 70.0° F (21.1°C) DB, 60.0° F (15.6°C) WB

OUTDOOR TEMPERATURE : 47.0° F (8.3°C) DB, 43.0° F (6.1°C) WB

EXTERNAL STATIC PRESSURE 0.4 in. WG (100Pa)

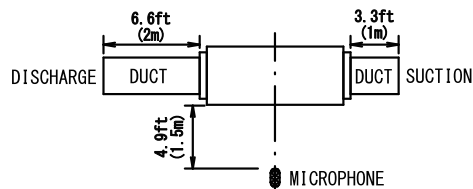

NOTE: OPERATION NOISE DIFFERS WITH OPERATION AND AMBIENT CONDITIONS.

**13.1.4 FTQ
FTQ18TAVJUD
FTQ18TAVJUA**

Sound levels tested in accordance with AHRI 260.

Ducted Inlet

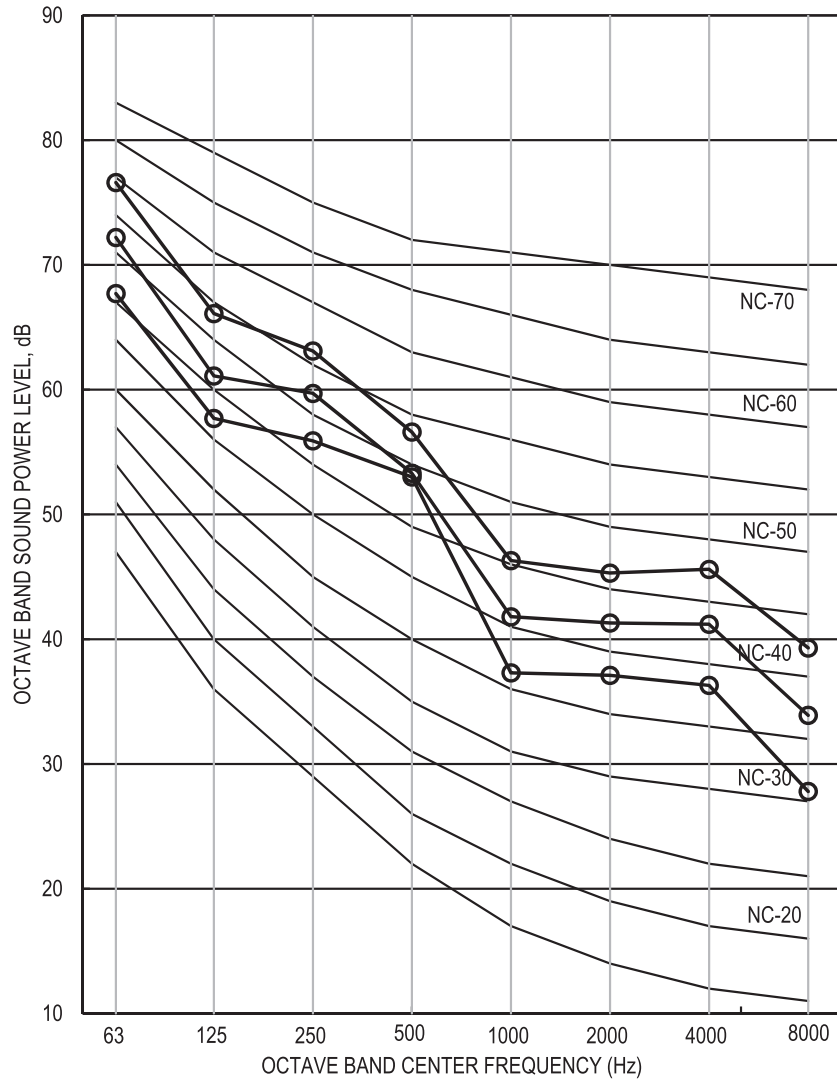

OVER ALL (dB)

TYPE	SCALE	H	M	L
Sound Power (Lw)	A	59	55.2	51.3
Sound Pressure (Lp)	A	50.7	46.8	44.1

**FTQ18TAVJUD
FTQ18TAVJUA**

Sound levels tested in accordance with AHRI 260.

Ducted Discharge

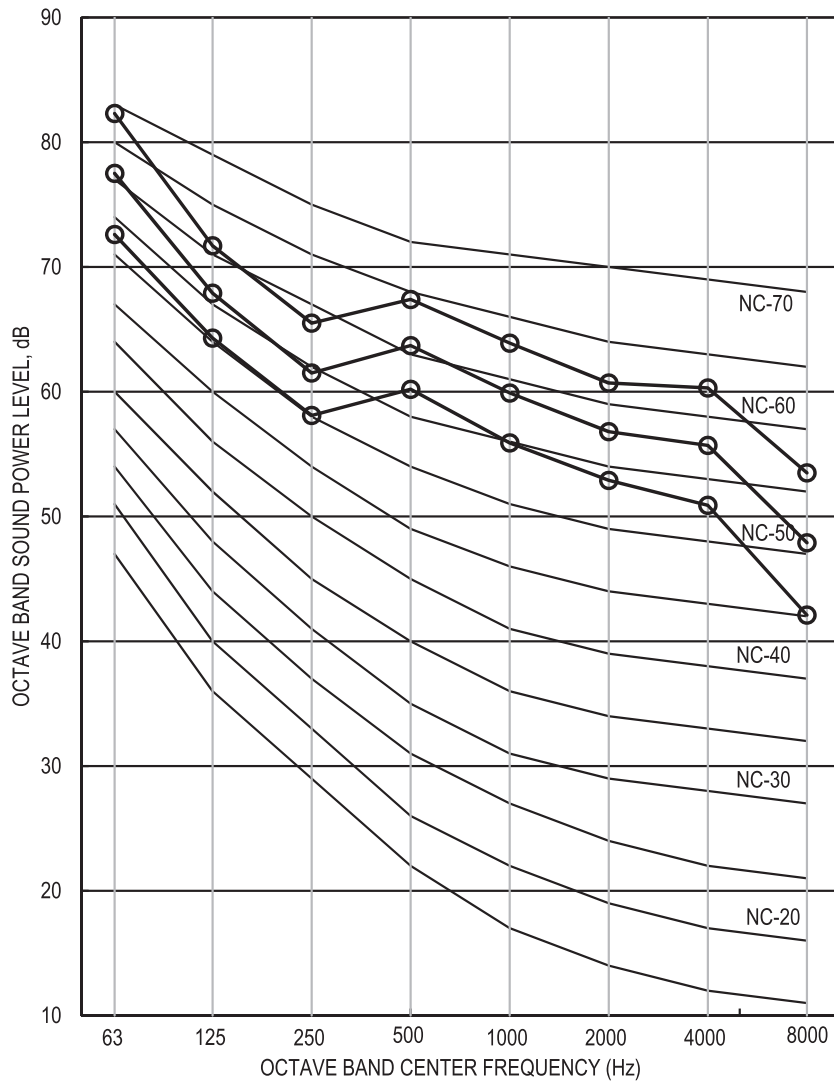

OVER ALL (dB)

TYPE	SCALE	H	M	L
Sound Power (Lw)	A	69.6	65.6	61.7
Sound Pressure (Lp)	A	59.9	55.9	52

**FTQ18TAVJUD
FTQ18TAVJUA**

Sound levels tested in accordance with AHRI 260.

Casing Radiated

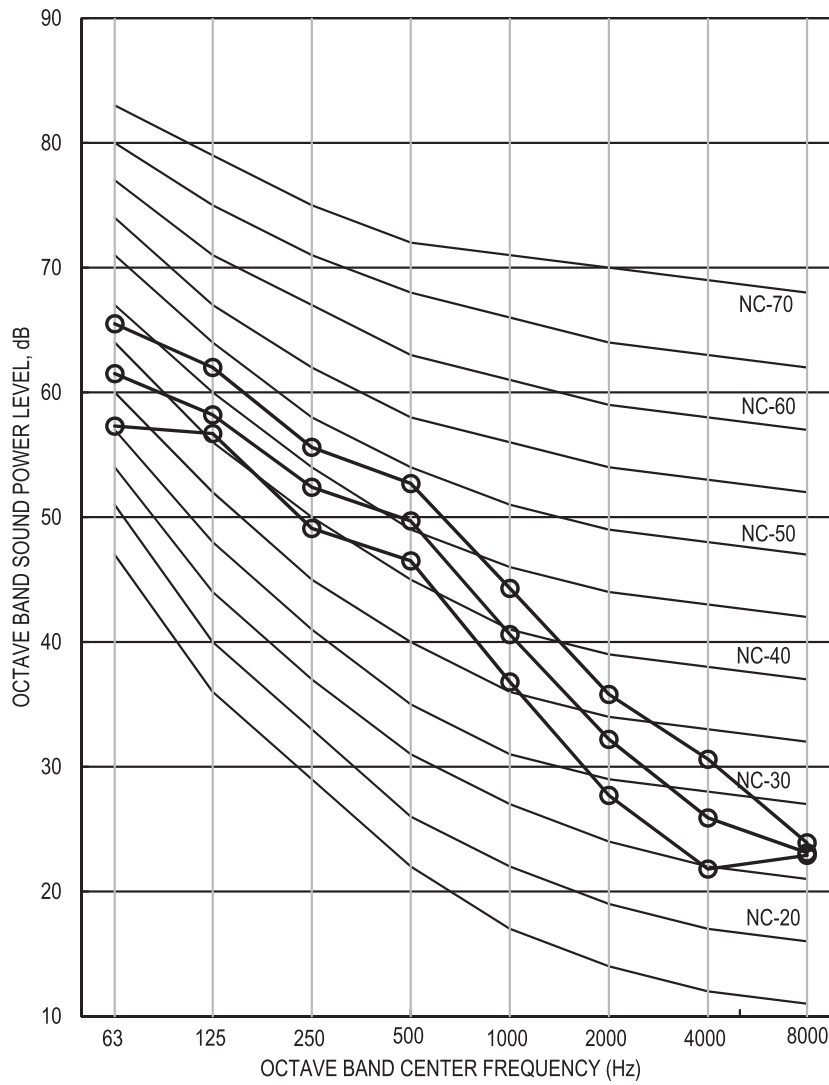

OVER ALL (dB)

TYPE	SCALE	H	M	L
Sound Power (Lw)	A	53.2	49.8	46.6
Sound Pressure (Lp)	A	44.6	41.3	38.4

**FTQ24TAVJUD
FTQ24TAVJUA**

Sound levels tested in accordance with AHRI 260.

Ducted Inlet

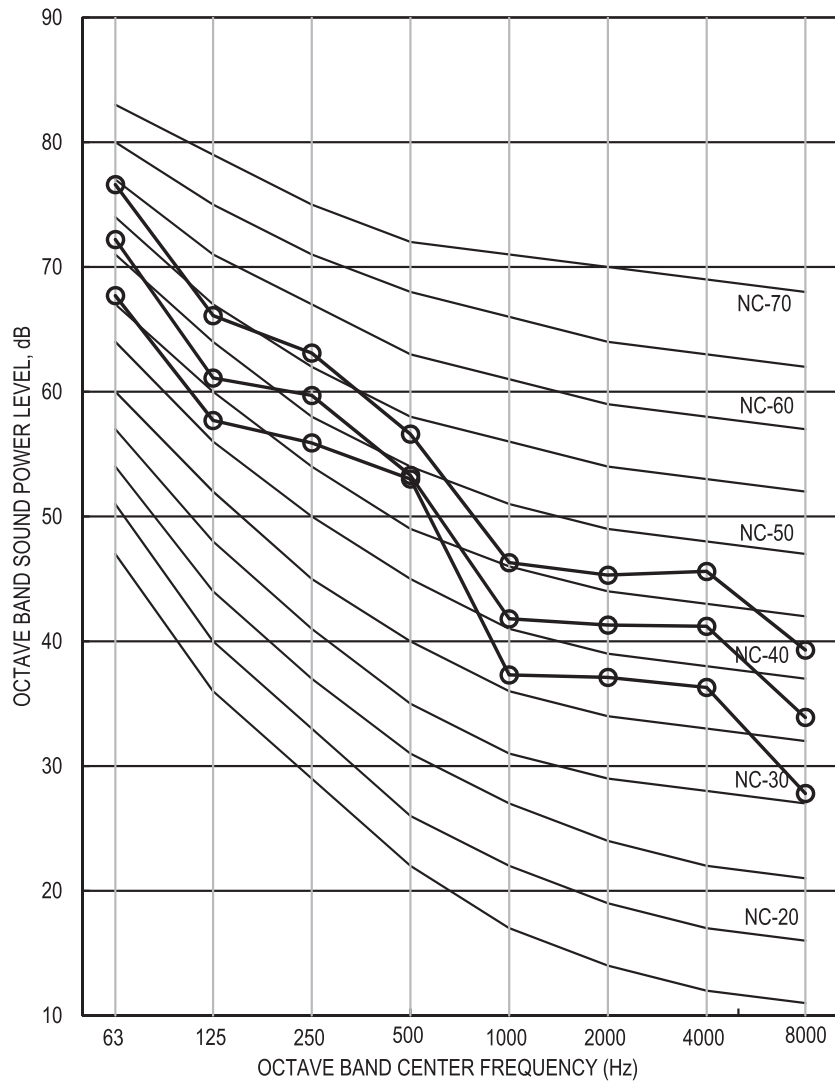

OVER ALL (dB)

TYPE	SCALE	H	M	L
Sound Power (Lw)	A	59	55.2	51.3
Sound Pressure (Lp)	A	50.7	46.8	44.1

**FTQ24TAVJUD
FTQ24TAVJUA**

Sound levels tested in accordance with AHRI 260.

Ducted Discharge

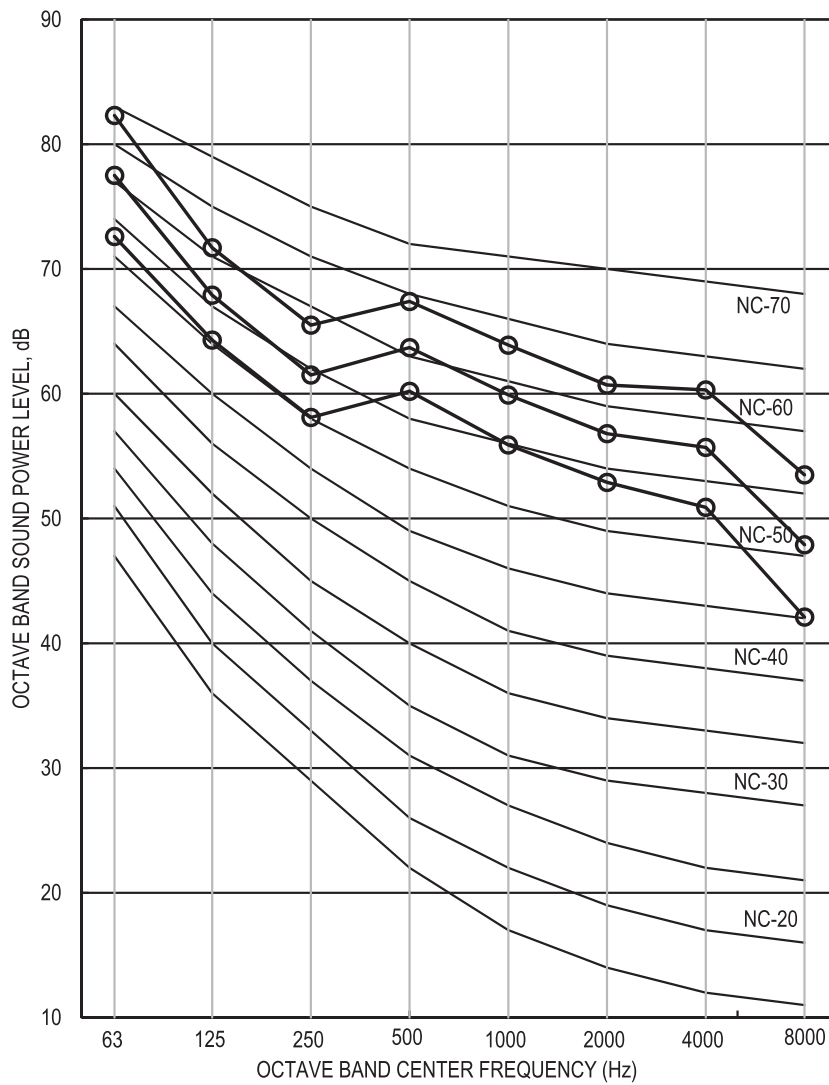

OVER ALL (dB)

TYPE	SCALE	H	M	L
Sound Power (Lw)	A	69.6	65.6	61.7
Sound Pressure (Lp)	A	59.9	55.9	52

**FTQ24TAVJUD
FTQ24TAVJUA**

Sound levels tested in accordance with AHRI 260.

Casing Radiated

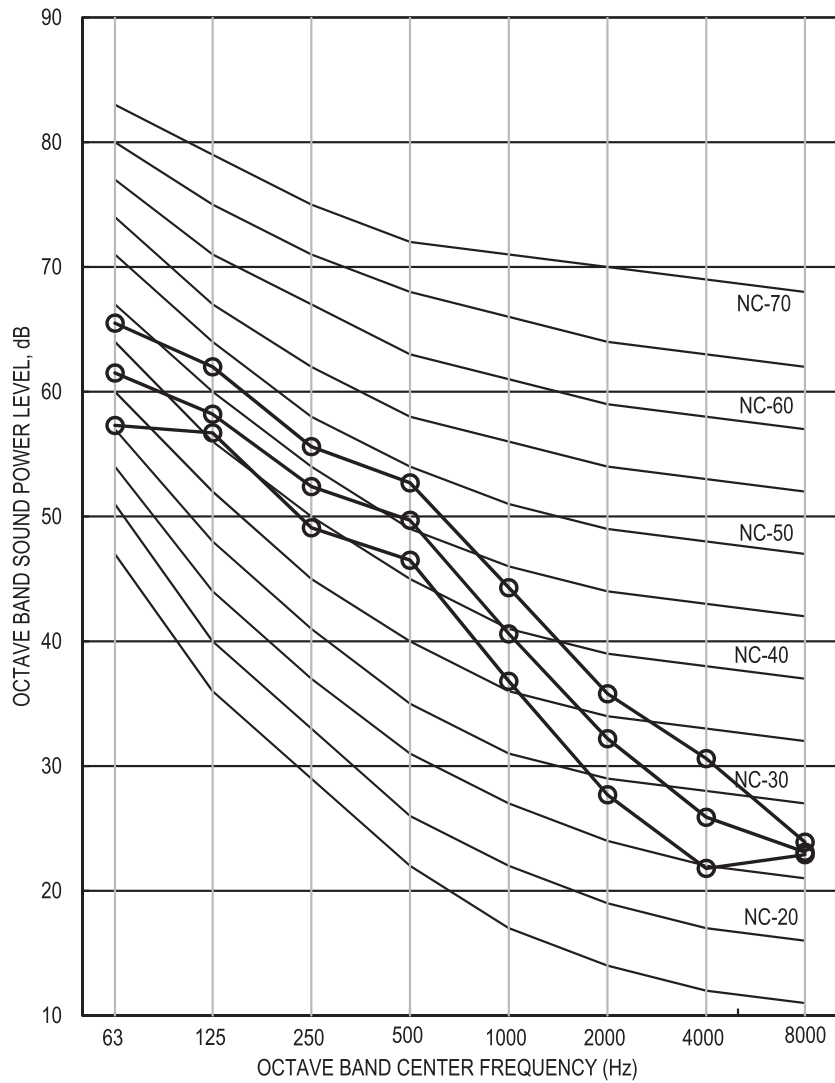

OVER ALL (dB)

TYPE	SCALE	H	M	L
Sound Power (Lw)	A	53.2	49.8	46.6
Sound Pressure (Lp)	A	44.6	41.3	38.4

**FTQ30TAVJUD
FTQ30TAVJUA**

Sound levels tested in accordance with AHRI 260.

Ducted Inlet

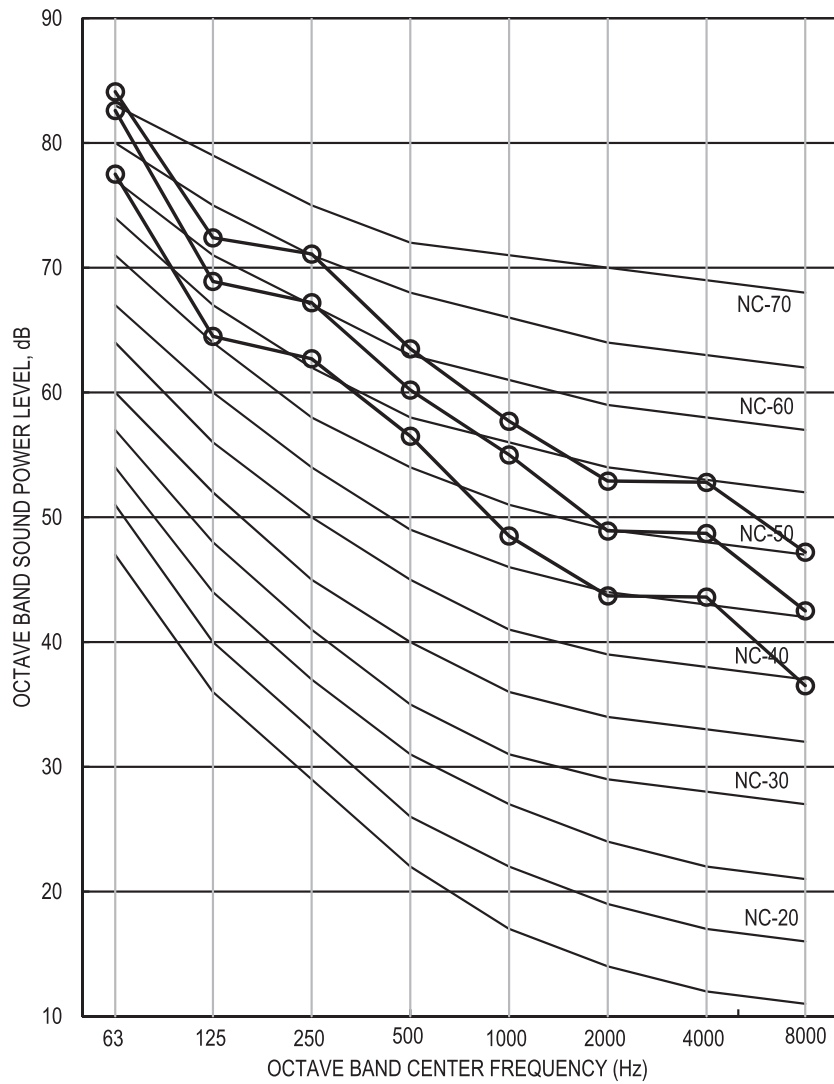

OVER ALL (dB)

TYPE	SCALE	H	M	L
Sound Power (Lw)	A	66.6	63.2	58.5
Sound Pressure (Lp)	A	58.3	55.2	50.6

**FTQ30TAVJUD
FTQ30TAVJUA**

Sound levels tested in accordance with AHRI 260.

Ducted Discharge

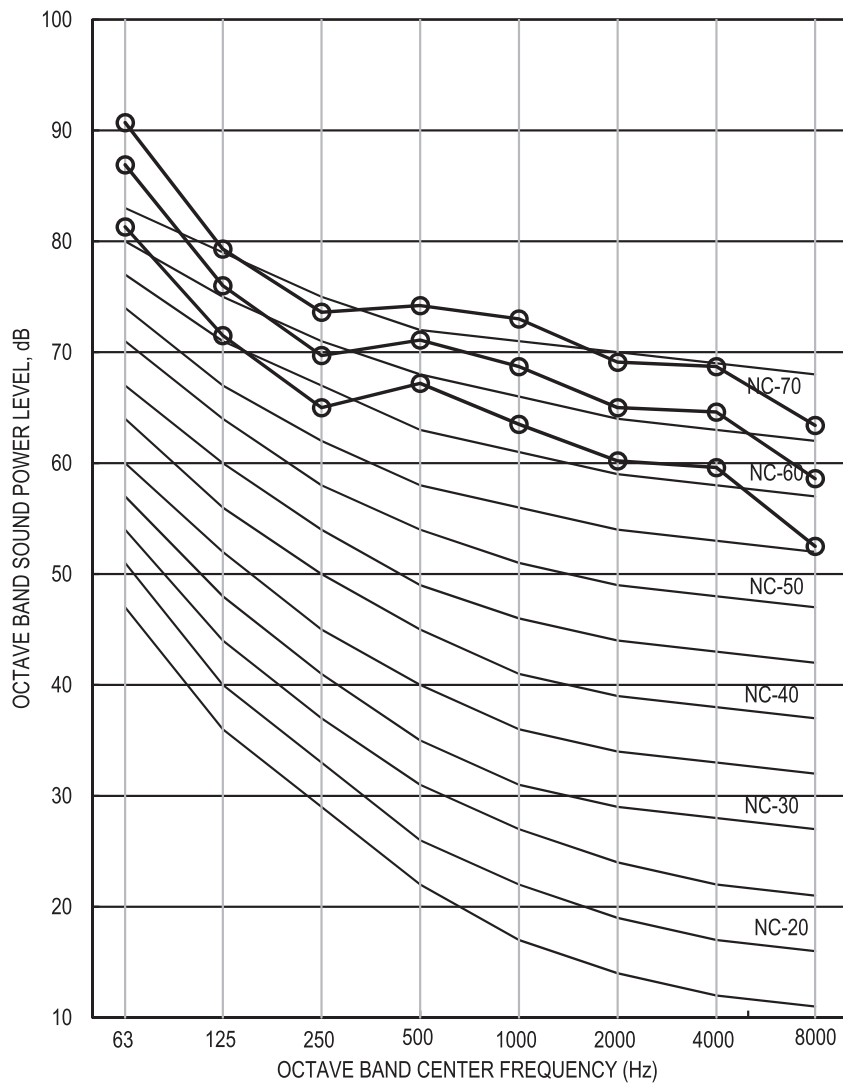

OVER ALL (dB)

TYPE	SCALE	H	M	L
Sound Power (Lw)	A	77.8	73.9	69.3
Sound Pressure (Lp)	A	68	64.1	59.5

FTQ30TAVJUD
FTQ30TAVJUA

Sound levels tested in accordance with AHRI 260.

Casing Radiated

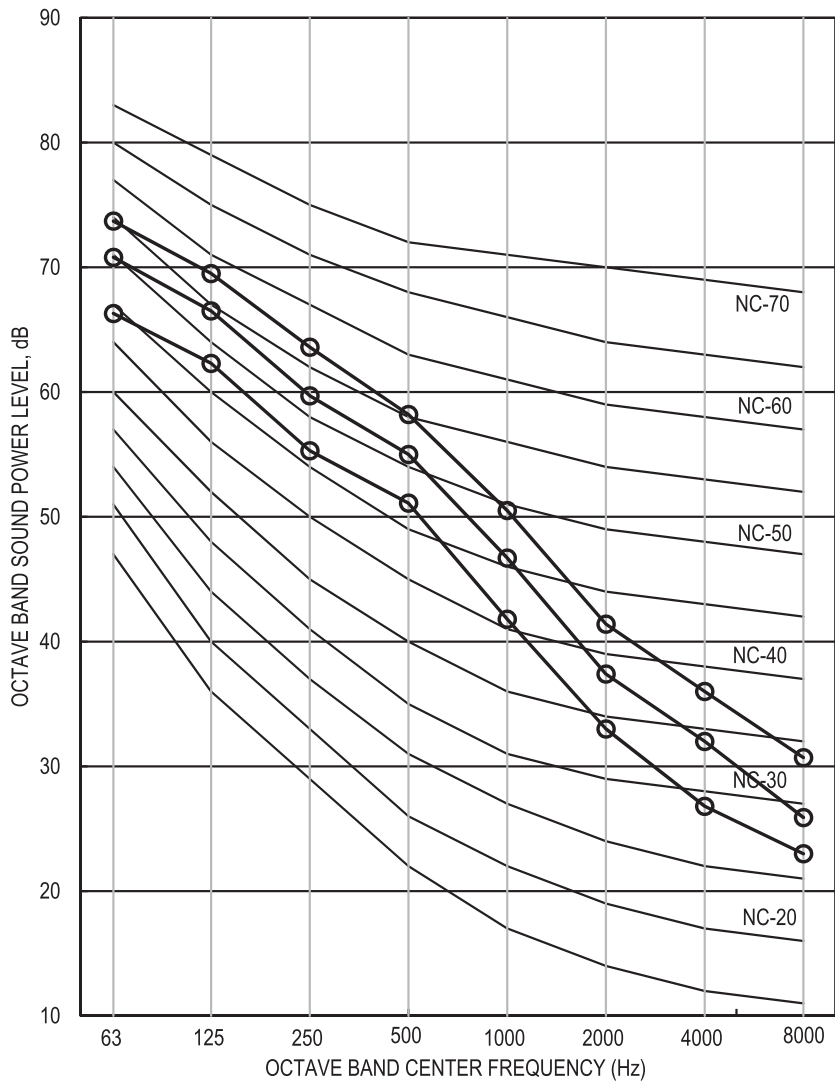

OVER ALL (dB)

TYPE	SCALE	H	M	L
Sound Power (Lw)	A	59.8	56.3	52.1
Sound Pressure (Lp)	A	51.6	48.2	44

**FTQ36TAVJUD
FTQ36TAVJUA**

Sound levels tested in accordance with AHRI 260.

Ducted Inlet

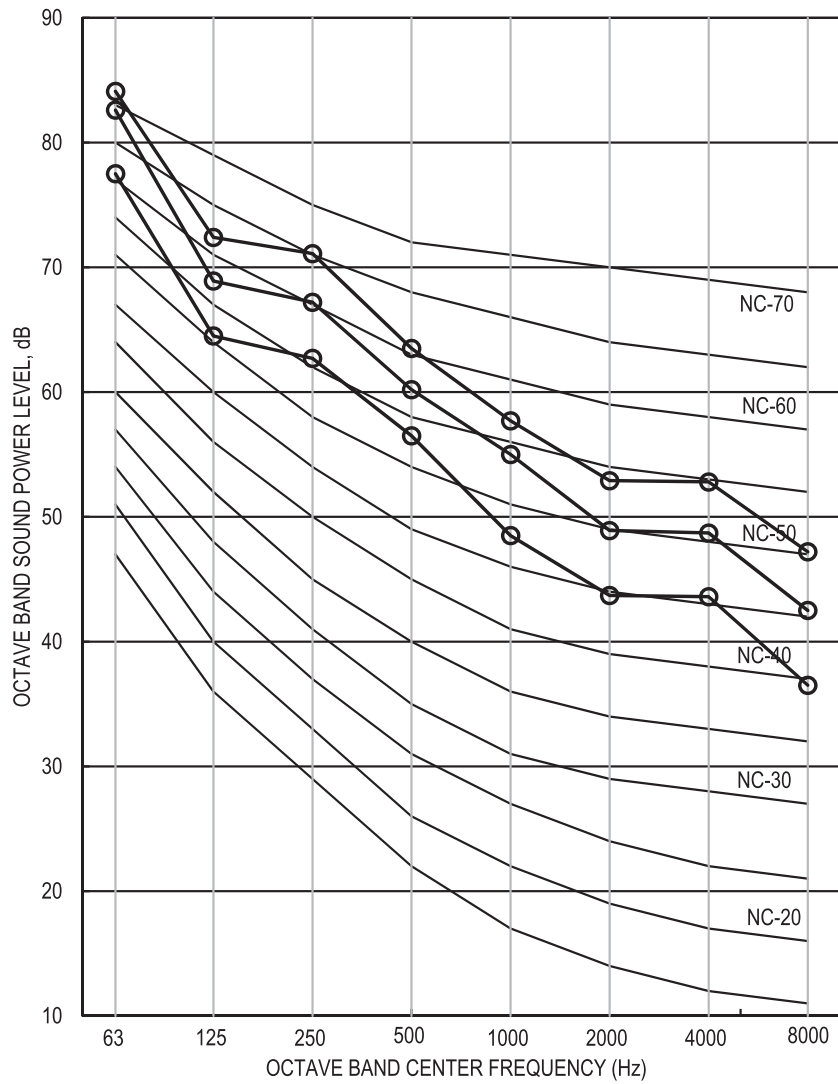

OVER ALL (dB)

TYPE	SCALE	H	M	L
Sound Power (Lw)	A	66.6	63.2	58.5
Sound Pressure (Lp)	A	58.3	55.2	50.6

**FTQ36TAVJUD
FTQ36TAVJUA**

Sound levels tested in accordance with AHRI 260.

Ducted Discharge

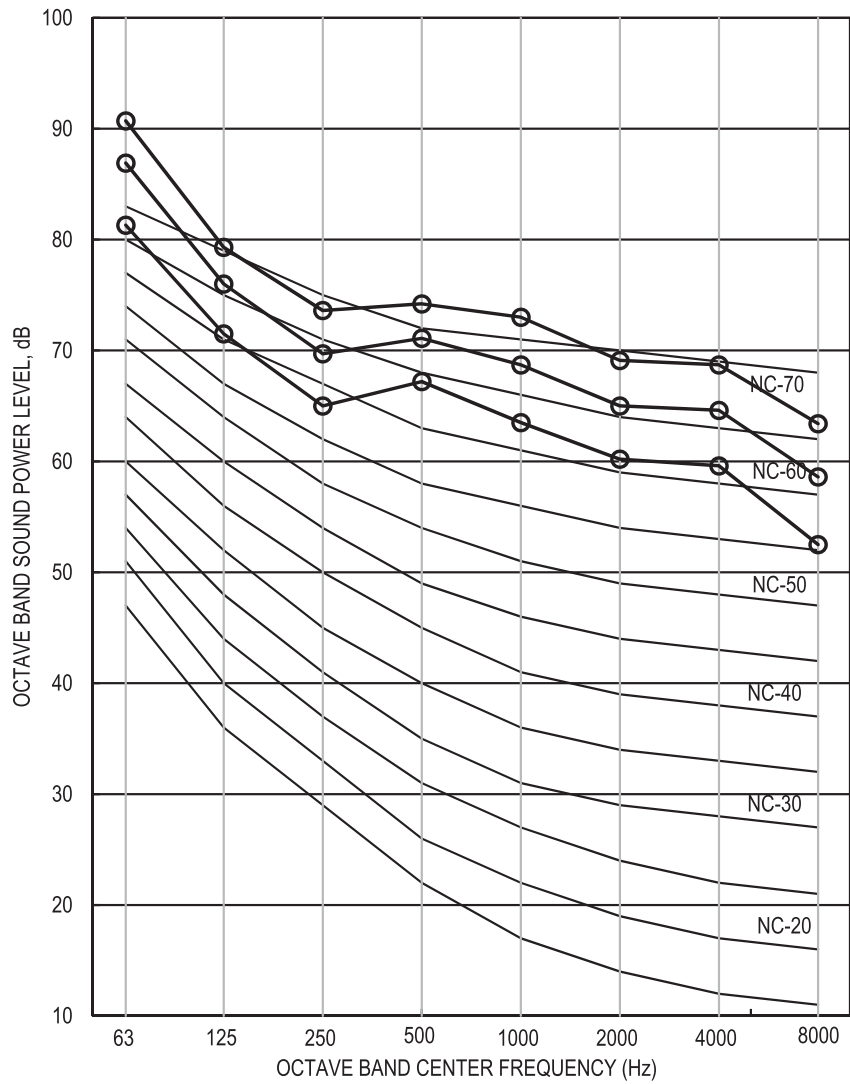

OVER ALL (dB)

TYPE	SCALE	H	M	L
Sound Power (Lw)	A	77.8	73.9	69.3
Sound Pressure (Lp)	A	68	64.1	59.5

**FTQ36TAVJUD
FTQ36TAVJUA**

Sound levels tested in accordance with AHRI 260.

Casing Radiated

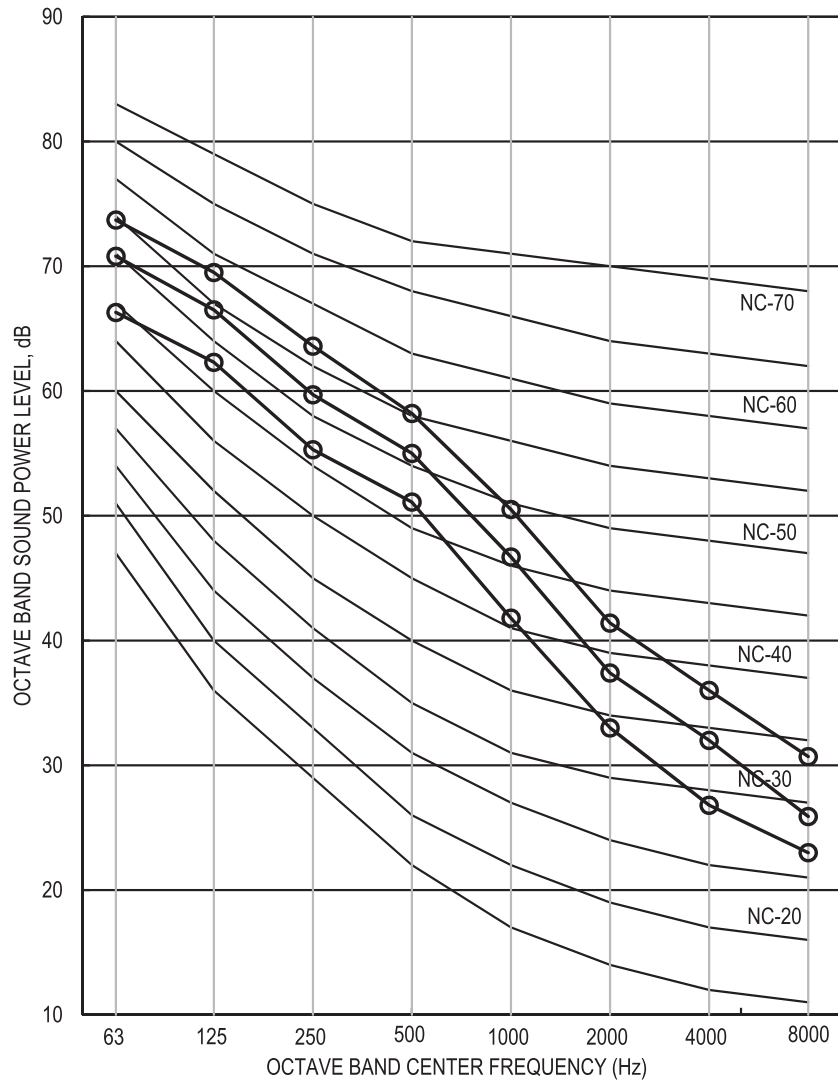

OVER ALL (dB)

TYPE	SCALE	H	M	L
Sound Power (Lw)	A	59.8	56.3	52.1
Sound Pressure (Lp)	A	51.6	48.2	44

**FTQ42TAVJUD
FTQ42TAVJUA**

Sound levels tested in accordance with AHRI 260.

Ducted Inlet

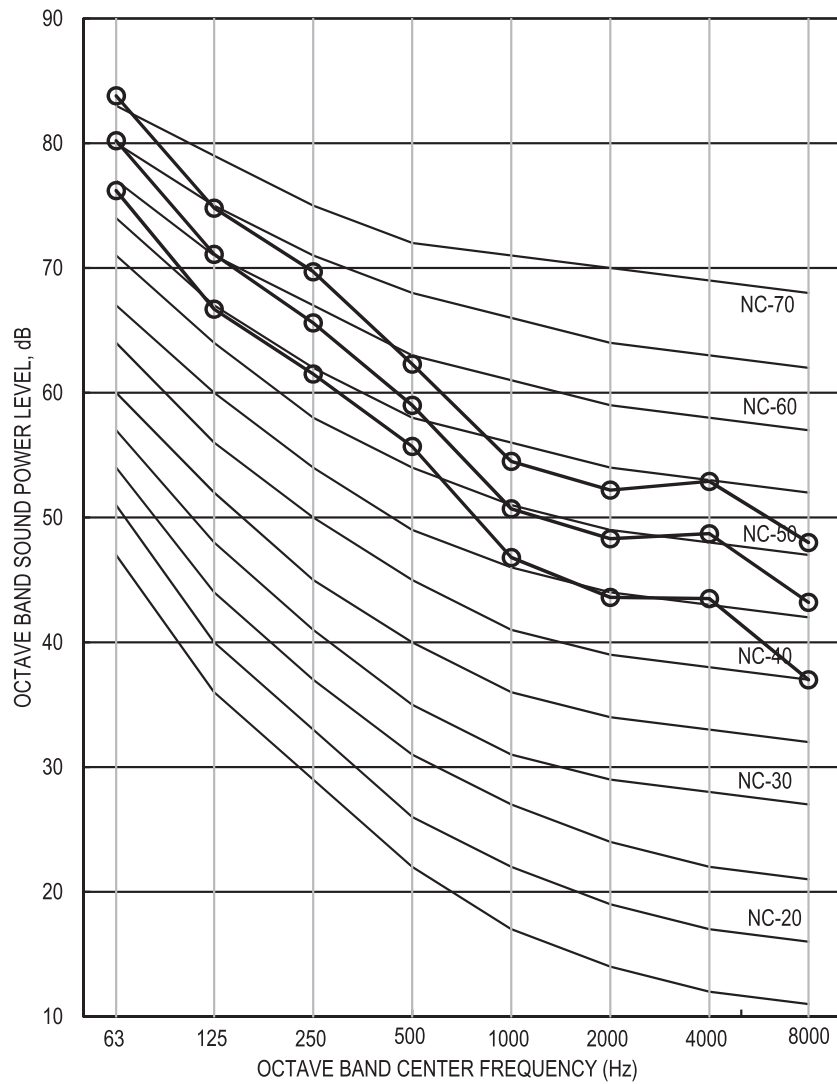

OVER ALL (dB)

TYPE	SCALE	H	M	L
Sound Power (Lw)	A	65.7	61.9	57.9
Sound Pressure (Lp)	A	57.7	54	50

**FTQ42TAVJUD
FTQ42TAVJUA**

Sound levels tested in accordance with AHRI 260.

Ducted Discharge

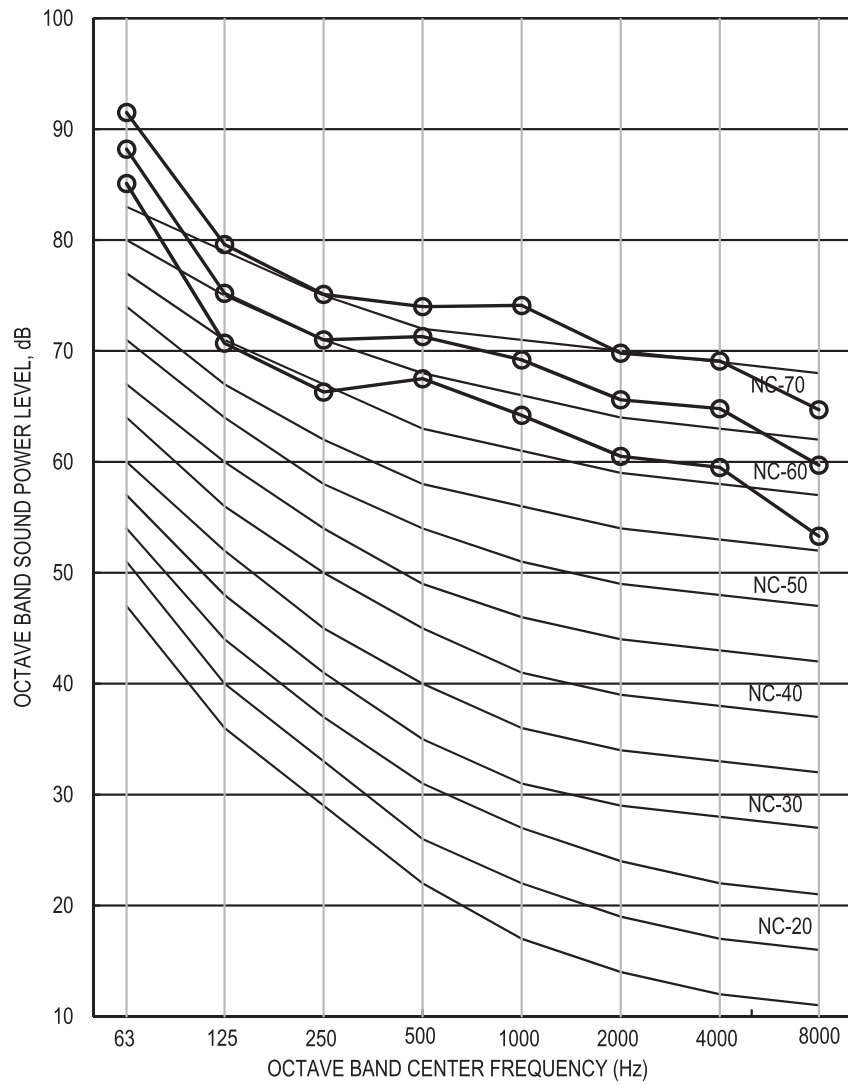

OVER ALL (dB)

TYPE	SCALE	H	M	L
Sound Power (Lw)	A	78.4	74.3	69.5
Sound Pressure (Lp)	A	68.6	64.6	60.2

**FTQ42TAVJUD
FTQ42TAVJUA**

Sound levels tested in accordance with AHRI 260.

Casing Radiated

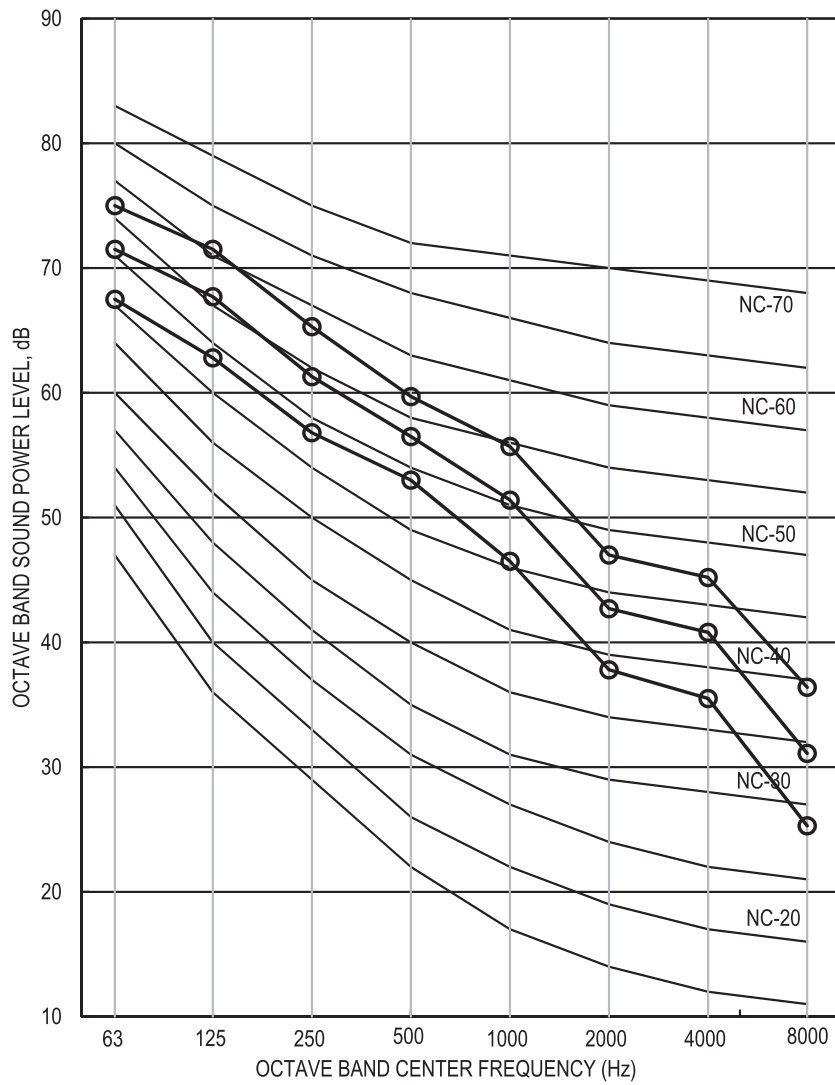

OVER ALL (dB)

TYPE	SCALE	H	M	L
Sound Power (Lw)	A	62.2	58.5	54.2
Sound Pressure (Lp)	A	53.8	50	45.6

**FTQ48TAVJUD
FTQ48TAVJUA**

Sound levels tested in accordance with AHRI 260.

Ducted Inlet

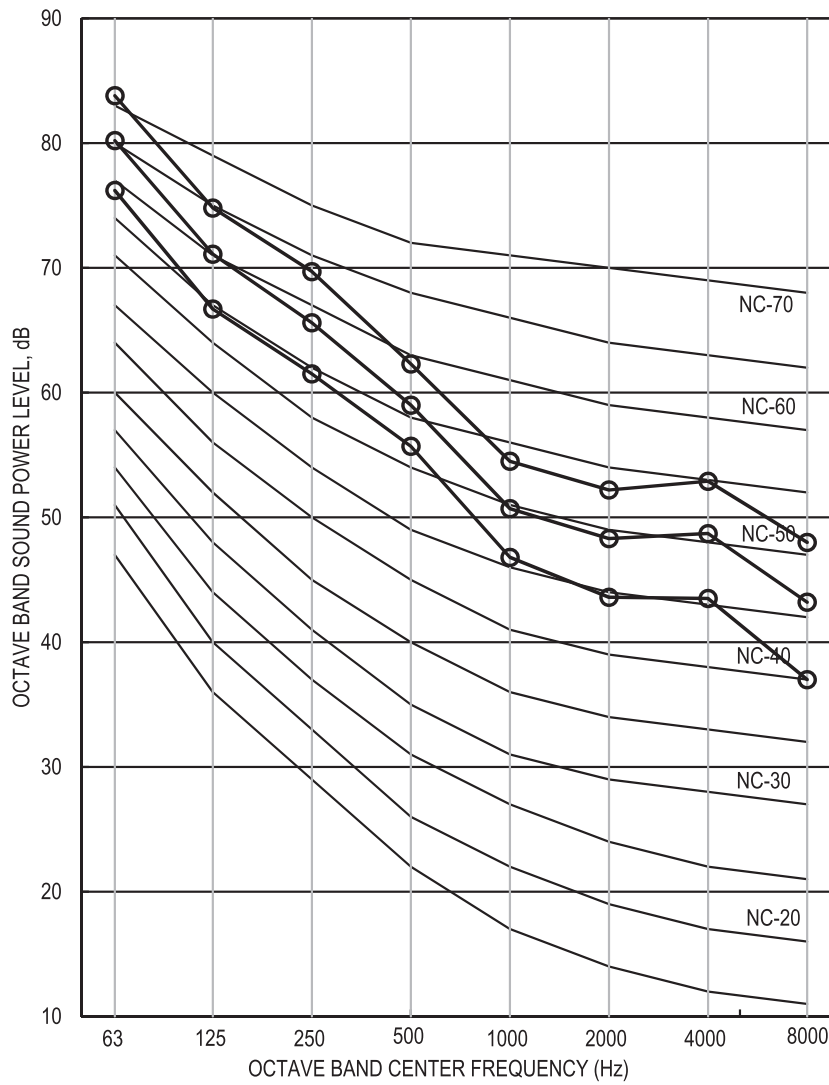

OVER ALL (dB)

TYPE	SCALE	H	M	L
Sound Power (Lw)	A	65.7	61.9	57.9
Sound Pressure (Lp)	A	57.7	54	50

**FTQ48TAVJUD
FTQ48TAVJUA**

Sound levels tested in accordance with AHRI 260.

Ducted Discharge

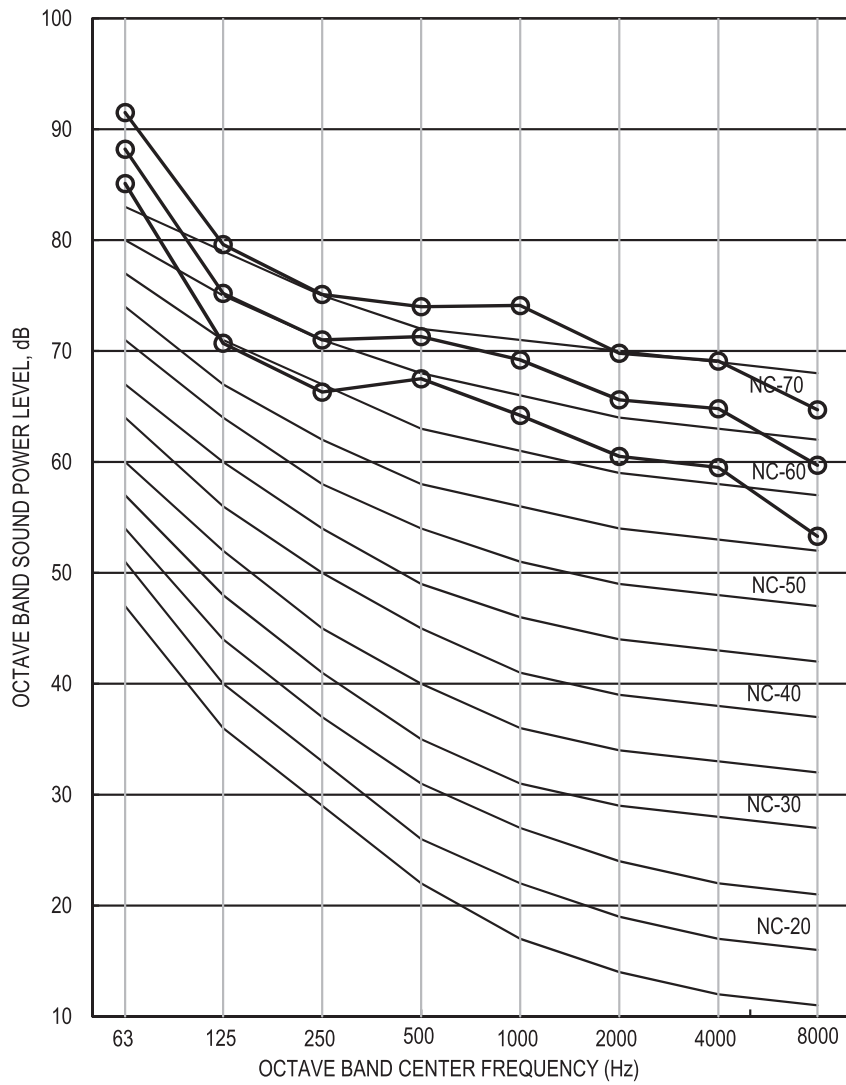

OVER ALL (dB)

TYPE	SCALE	H	M	L
Sound Power (Lw)	A	78.4	74.3	69.5
Sound Pressure (Lp)	A	68.6	64.6	60.2

**FTQ48TAVJUD
FTQ48TAVJUA**

Sound levels tested in accordance with AHRI 260.

Casing Radiated

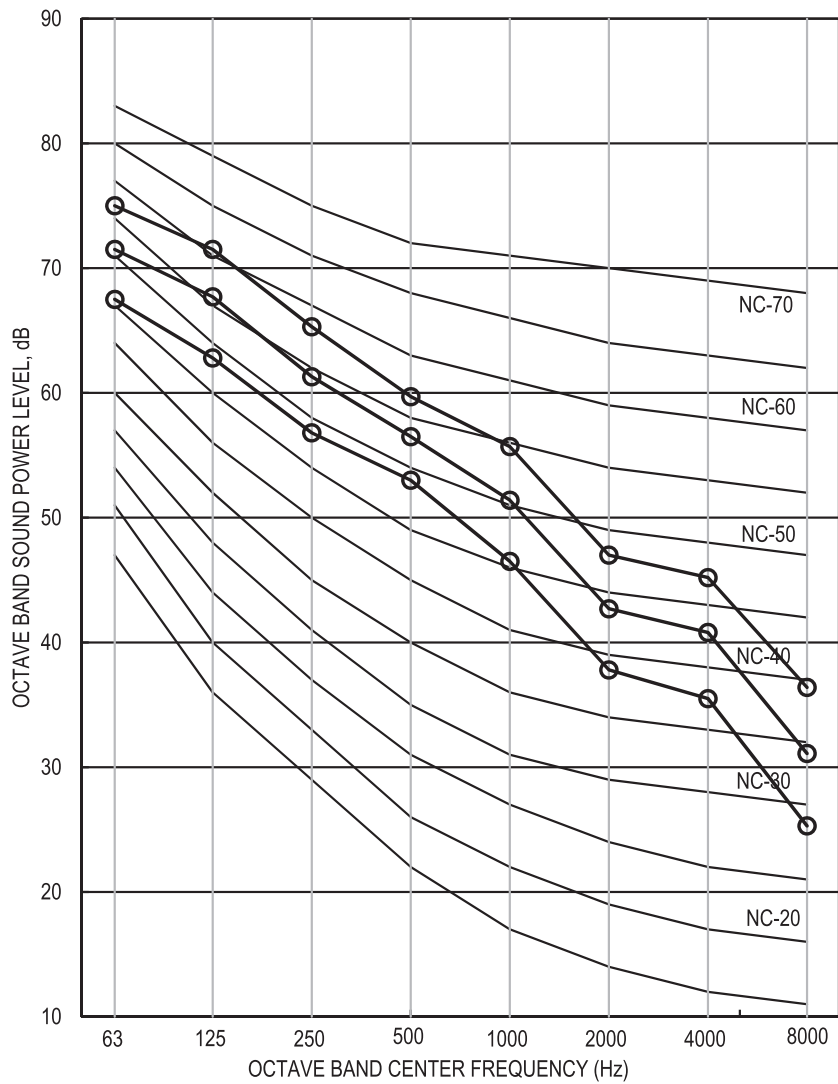

OVER ALL (dB)

TYPE	SCALE	H	M	L
Sound Power (Lw)	A	62.2	58.5	54.2
Sound Pressure (Lp)	A	53.8	50	45.6

13.2 Outdoor Unit (Cooling Only) RZR18 - 24TBVJUA

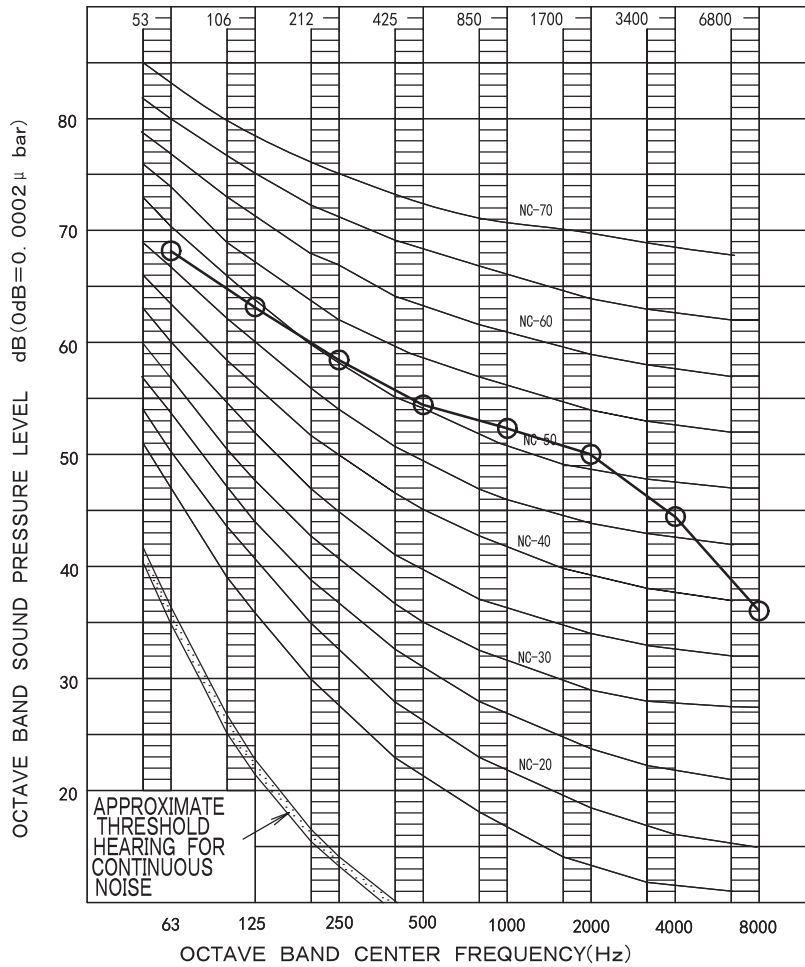

OVER ALL (dB)

SCALE	A	58
-------	---	----

OPERATING CONDITIONS

POWER SOURCE 208/230V 60Hz

COOLING RETURN AIR TEMPERATURE: 80.0°FDB (26.7°CDB), 67.0°FWB (19.4°CWB)
OUTDOOR TEMPEARATURE: 95.0°FDB (35.0°CDB), 75.0°FWB (23.9°CWB)

(B. G. N IS ALREADY RECTIFIED)

MEASURING PLACE

ANECHOIC CHAMBER

LOCATION OF MICROPHONE

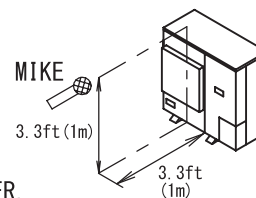

NOTE: THE OPERATING SOUND IS MEASURED IN ANECHOIC CHAMBER,
IF IT IS MEASURED UNDER THE ACTUAL INSTALLATION CONDITIONS,
IT IS NORMALLY OVER THE SET VALUE DUE TO ENVIRONMENTAL NOISE AND SOUND REFLECTION.

RZR30 - 48TBVJUA

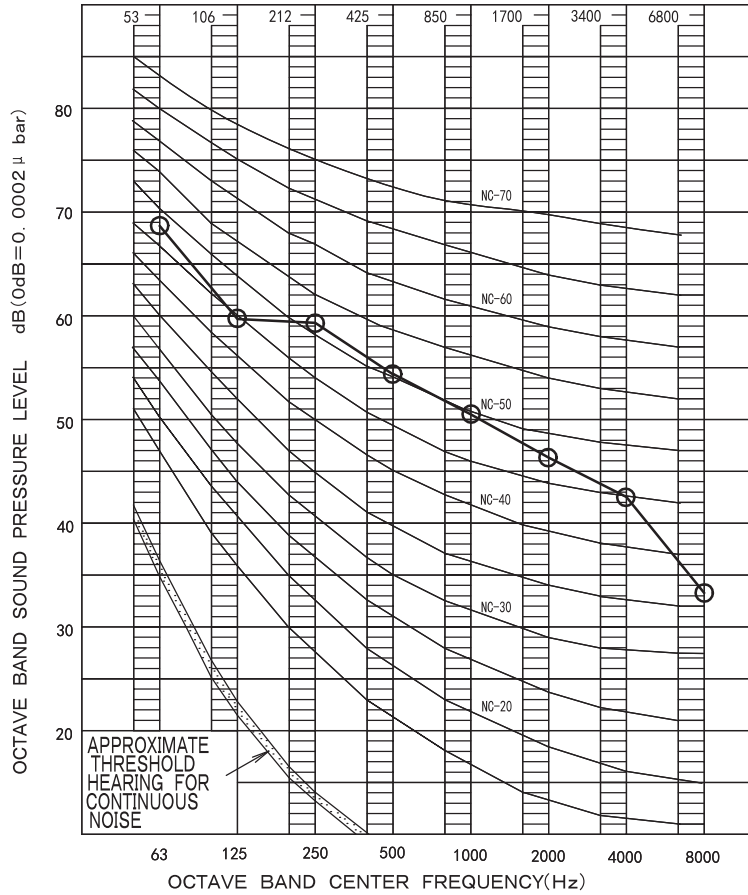

OVER ALL (dB)

SCALE	A	57
-------	---	----

OPERATING CONDITIONS

POWER SOURCE 208/230V 60Hz

COOLING RETURN AIR TEMPERATURE: 80.0°FDB (26.7°CDB), 67.0°FWB (19.4°CWB)
 OUTDOOR TEMPEARATURE: 95.0°FDB (35.0°CDB), 75.0°FWB (23.9°CWB)

(B. G. N IS ALREADY RECTIFIED)

MEASURING PLACE

ANECHOIC CHAMBER

LOCATION OF MICROPHONE

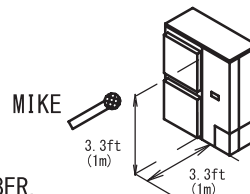

NOTE: THE OPERATING SOUND IS MEASURED IN ANECHOIC CHAMBER.
 IF IT IS MEASURED UNDER THE ACTUAL INSTALLATION CONDITIONS,
 IT IS NORMALLY OVER THE SET VALUE DUE TO ENVIRONMENTAL NOISE AND SOUND REFLECTION.

13.3 Outdoor Unit (Heat Pump) RZQ18 - 24TBVJUA (cooling)

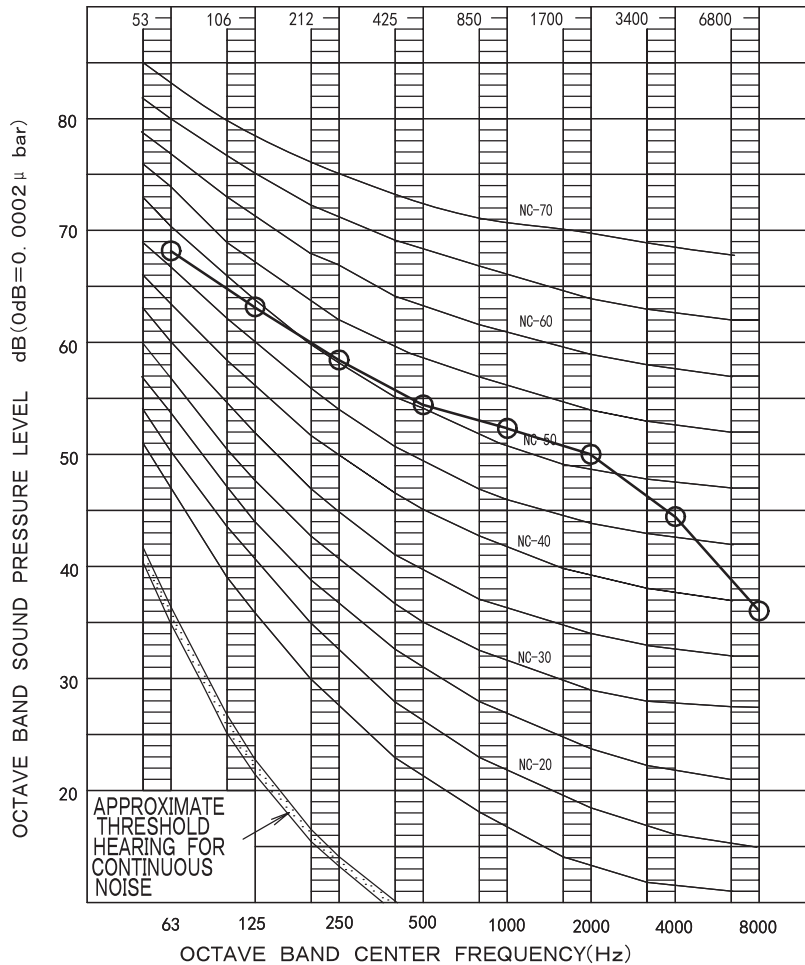

OVER ALL (dB)

SCALE	A	58
-------	---	----

OPERATING CONDITIONS

POWER SOURCE 208/230V 60Hz

COOLING RETURN AIR TEMPERATURE: 80.0°FDB (26.7°CDB), 67.0°FWB (19.4°CWB)
OUTDOOR TEMPEARATURE: 95.0°FDB (35.0°CDB), 75.0°FWB (23.9°CWB)

(B. G. N IS ALREADY RECTIFIED)

MEASURING PLACE

ANECHOIC CHAMBER

LOCATION OF MICROPHONE

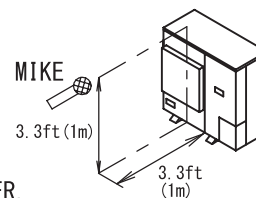

NOTE: THE OPERATING SOUND IS MEASURED IN ANECHOIC CHAMBER, IF IT IS MEASURED UNDER THE ACTUAL INSTALLATION CONDITIONS, IT IS NORMALLY OVER THE SET VALUE DUE TO ENVIRONMENTAL NOISE AND SOUND REFLECTION.

RZQ18 - 24TBVJUA (heating)

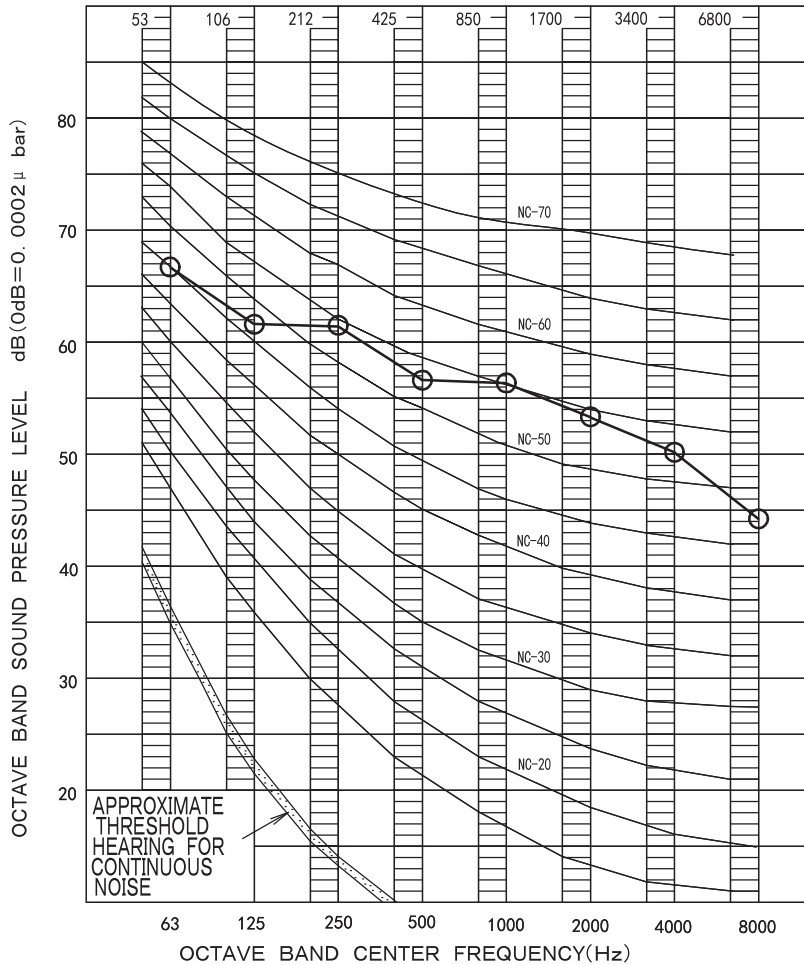

OVER ALL (dB)

SCALE	A	61
-------	---	----

OPERATING CONDITIONS

POWER SOURCE 208/230V 60Hz

HEATING RETURN AIR TEMPERATURE: 70.0°FDB (21.1°CDB)
 OUTDOOR TEMPEARATURE: 47.0°FDB (8.3°CDB), 43.0°FWB (6.1°CWB)

(B. G. N IS ALREADY RECTIFIED)

MEASURING PLACE

ANECHOIC CHAMBER

LOCATION OF MICROPHONE

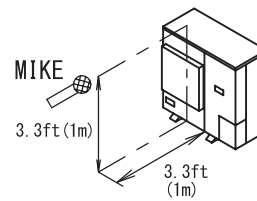

NOTE: THE OPERATING SOUND IS MEASURED IN ANECHOIC CHAMBER.
 IF IT IS MEASURED UNDER THE ACTUAL INSTALLATION CONDITIONS,
 IT IS NORMALLY OVER THE SET VALUE DUE TO ENVIRONMENTAL NOISE AND SOUND REFLECTION.
 WHEN FROSTING ON COIL, OPERATING SOUND MAY BECOME LARGER THAN THE ABOVE VALUE.

RZQ30 - 48TBVJUA (cooling)

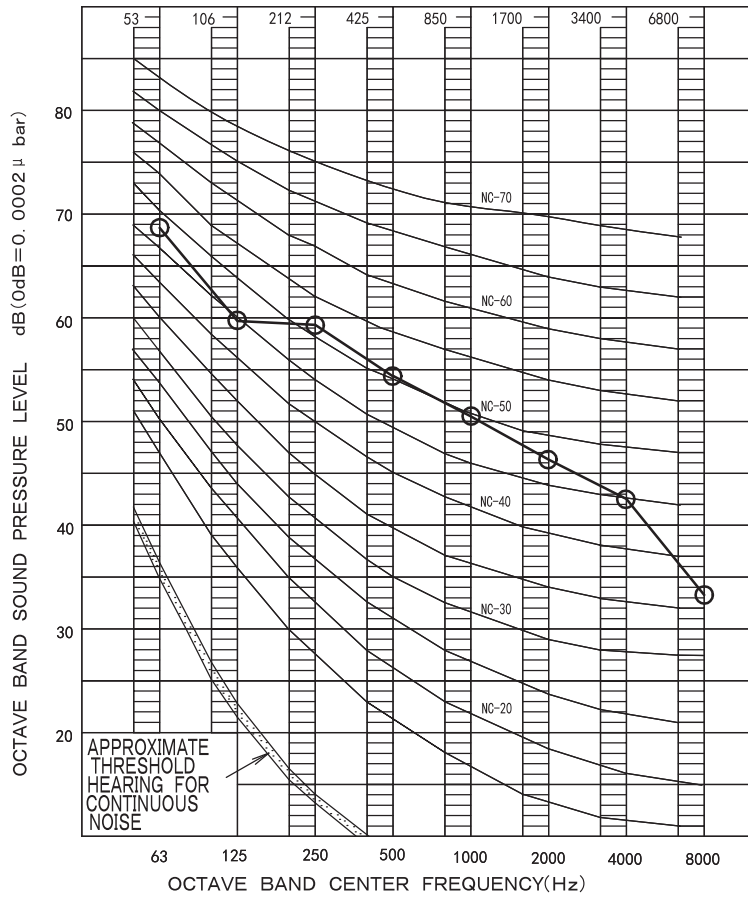

OVER ALL (dB)

SCALE	A	57
-------	---	----

OPERATING CONDITIONS

POWER SOURCE 208/230V 60Hz

COOLING RETURN AIR TEMPERATURE: 80.0°FDB (26.7°CDB), 67.0°FWB (19.4°CWB)
OUTDOOR TEMPEARATURE: 95.0°FDB (35.0°CDB), 75.0°FWB (23.9°CWB)

(B. G. N IS ALREADY RECTIFIED)

MEASURING PLACE

ANECHOIC CHAMBER

LOCATION OF MICROPHONE

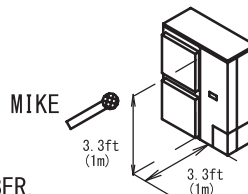

NOTE: THE OPERATING SOUND IS MEASURED IN ANECHOIC CHAMBER.
IF IT IS MEASURED UNDER THE ACTUAL INSTALLATION CONDITIONS,
IT IS NORMALLY OVER THE SET VALUE DUE TO ENVIRONMENTAL NOISE AND SOUND REFLECTION.

RZQ30 - 48TBVJUA (heating)

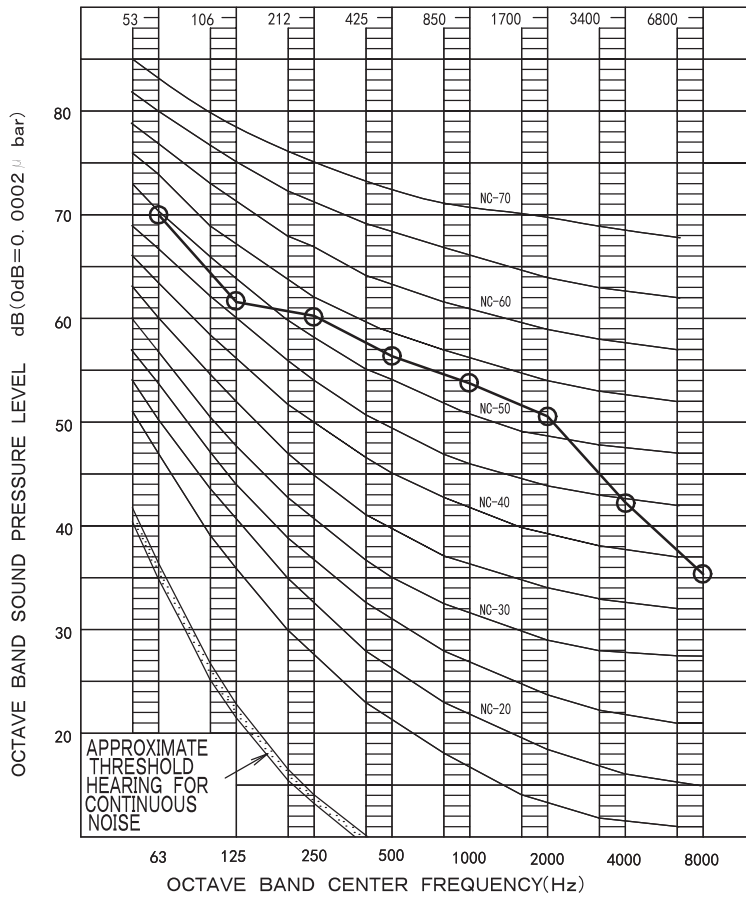

OVER ALL (dB)

SCALE	A	59
-------	---	----

OPERATING CONDITIONS

POWER SOURCE 208/230V 60Hz

HEATING RETURN AIR TEMPERATURE: 70.0°FDB (21.1°CDB)
 OUTDOOR TEMPEARATURE: 47.0°FDB (8.3°CDB), 43.0°FWB (6.1°CWB)

(B. G. N IS ALREADY RECTIFIED)

MEASURING PLACE

ANECHOIC CHAMBER

LOCATION OF MICROPHONE

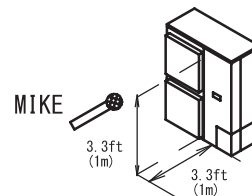

NOTE: THE OPERATING SOUND IS MEASURED IN ANECHOIC CHAMBER, IF IT IS MEASURED UNDER THE ACTUAL INSTALLATION CONDITIONS, IT IS NORMALLY OVER THE SET VALUE DUE TO ENVIRONMENTAL NOISE AND SOUND REFLECTION. WHEN FROSTING ON COIL, OPERATING SOUND MAY BECOME LARGER THAN THE ABOVE VALUE.

14. Accessories

14.1 Indoor Unit

14.1.1 FCQ

Optional accessories (for unit)

Item		Note	Model			
			FCQ18 - 24AAVJU	FCQ30 - 48AAVJU	FCQ18 - 24AAVJU	FCQ30 - 48AAVJU
Type of panel			Self-cleaning filter panel		Standard sensing decoration panel	
Self-cleaning filter panel			BYCQ54EEGFU		—	
Connection pipe (for dust recovery)			KKHAP55B160		—	
L-shape extension pipe			KKHAP55A160		—	
Standard sensing decoration panel			—		BYCQ54EEFU	
Sealing material for air discharge outlet		For 1 outlet	KDBH551C160			
		For 2 outlets	—		KDBH552C160	
Panel spacer			KDB55J160F			
Fresh air intake kit	Chamber type	Without T-shape pipe	—		KDDP55C160	
		With T-shape pipe	—		KDDP55C160K	
	Direct installation type		—		KDDP55X160A	
Filter chamber			—		KDDFP55C160	
Replacement long life filter			—		KAF551D160	
Ultra long life filter unit			—		KAF555D160	
Replacement ultra long life filter			—		KAF550D160	
Self-cleaning filter panel replacement filter			KAF554D160		—	
Branch duct chamber			KDJP55C80	KDJP55C160	KDJP55C80	KDJP55C160

C: 3D141052A

Optional accessories (for controls)

Item		Note	Model			
			FCQ18 - 24AAVJU	FCQ30 - 48AAVJU	FCQ18 - 24AAVJU	FCQ30 - 48AAVJU
Remote controller	Wired type	Navigation	BRC1E73			
		MADOKA	BRC1H71W			
		Daikin One+ Smart Thermostat	DTST-ONE-ADA-A			
Wireless type			—			
intelligent Touch Manager			DCM601B71, DCM601A72			
Wiring adaptor PCB		1	KRP1C77			
Wiring adaptor for electrical appendices		1	KRP4A74			
External control adaptor for outdoor unit		1	DTA104A62			
DIII-NET expander adaptor			DTA109A51			
Remote sensor			KRCS01-5B			
Installation box for adaptor PCB		2, 3	KRP1J98A		KRP1H98A	

C: 3D141052A

Note:

1. Installation box for adaptor printed circuit board (KRP1J98A/KRP1H98A) is necessary.
2. Up to two adaptors can be fixed for each installation box.
3. Only one installation box can be installed to each indoor unit.

14.1.2 FAQ

Optional accessories (for controls)

No.	Item		Model	
			FAQ18TAVJU	FAQ24TAVJU
1	Remote controller	Wired type	Navigation	BRC1E73
			MADOKA	BRC1H71W
			Daikin One+ Smart Thermostat	DTST-ONE-ADA-A
		Wireless type	BRC7E818	
2	Remote sensor (for wireless remote controller)		KRCS01-1B	
3	intelligent Touch Manager		DCM601B71, DCM601A72	
4	DIII-NET expander adaptor		DTA109A51	
5	Wiring adaptor PCB		—	
6	Wiring adaptor for electrical appendices		KRP4A71	

C: 3D155535

14.1.3 FBQ

Optional accessories (for unit)

Item	Model	
	FBQ18 - 24TBVJU	FBQ30 - 48TBVJU
Shield plate for side plate	KDBD63A160	

C: 3D140816

Optional accessories (for controls)

No.	Item		Model	
			FBQ18 - 24TBVJU	FBQ30 - 48TBVJU
1	Remote controller	Wired type	Navigation	BRC1E73
			MADOKA	BRC1H71W
			Daikin One+ Smart Thermostat	DTST-ONE-ADA-A
		Wireless type	BRC082A43	
2	Remote sensor (for wireless remote controller)		KRCS01-6B	
3	intelligent Touch Manager		DCM601B71, DCM601A72	
4	DIII-NET expander adaptor		DTA109A51	
5	Wiring adaptor PCB		★ KRP1C76	
6	External control adaptor for outdoor unit		★ DTA104A61	
7	Wiring adaptor for electrical appendices		★ KRP4A71	
8	Fixing plate		KRP4A98	

C: 3D140814

Note:

1. Fixing plate (No.8) is necessary for each adaptor marked ★.
2. Up to 2 adaptor printed circuit boards can be installed in the fixing plate (No. 8).
3. Only 1 fixing plate can be installed for each indoor unit.

14.1.4 FTQ

Optional accessories (for unit)

Model	Electric heater capacity						
	HKS*03XC*	HKS*05XC*	HKS*06XC*	HKS*08XC*	HKS*10XC*	HKS*15*##* (Note 1)	HKSC19C*##* (Note 1)
FTQ18TAVJUD FTQ18TAVJUA	✓	✓	✓	✓	✓	×	×
FTQ24TAVJUD FTQ24TAVJUA	✓	✓	✓	✓	✓	×	×
FTQ30TAVJUD FTQ30TAVJUA	✓	✓	✓	✓	✓	×	×
FTQ36TAVJUD FTQ36TAVJUA	✓	✓	✓	✓	✓	×	×
FTQ42TAVJUD FTQ42TAVJUA	×	✓	✓	✓	✓	✓	✓
FTQ48TAVJUD FTQ48TAVJUA	×	✓	✓	✓	✓	✓	✓

Note:

- Two-stage heater control.
- All combinations of indoor unit capacity & heater capacity may be configured as either Auxiliary Heat or Heat Pump Lockout Heat. Refer to the installation manual for more detail regarding the Auxiliary Heat control sequence.

Optional accessories (for controls)

No.	Item		Model						
			FTQ18TAVJUD FTQ18TAVJUA	FTQ24TAVJUD FTQ24TAVJUA	FTQ30TAVJUD FTQ30TAVJUA	FTQ36TAVJUD FTQ36TAVJUA	FTQ42TAVJUD FTQ42TAVJUA	FTQ48TAVJUD FTQ48TAVJUA	
1	Remote controller	Wired type	Navigation	BRC1E73					
			MADOKA	BRC1H71W					
		Wireless type	Daikin One+ Smart Thermostat	DTST-ONE-ADA-A					
				BRC4C82					
2	Remote sensor		KRCS01-2UA						
3	Wiring adaptor for electrical appendices		KRP4A74 (Note 1)						
4	Installation box for adaptor printed circuit board		KRP1BB101						
5	External control adaptor for outdoor unit (Must be installed on indoor units)		DTA104A53 (Note 1)						
6	Wiring adaptor PCB		KRP1C75 (Note 1)						
7	DIII-NET expander adaptor		DTA109A51						
8	intelligent Touch Manager		DCM601B71, DCM601A72						
9	Adaptor printed circuit board for multi tenant		DTA114A61 (Note 1)						
10	Downflow kit		DFK-B			DFK-C			
11	Washable air filter		ALFH16201E			ALFH1912201E			

Note:

- Installation box (No.4) is required for adaptor (No.3/5/6/9).

14.2 Outdoor Unit

Optional accessories (for unit)

Item	Model	
	RZR18 - 24TBVJUA RZQ18 - 24TBVJUA	RZR30 - 48TBVJUA RZQ30 - 48TBVJUA
ABC I/P printed circuit board kit	—	BRP2A82

C: 4D143167

15. Caution Label

15.1 RZR18 - 24TBVJUA, RZQ18 - 24TBVJUA

Service precautions



Warning



Caution to electric shock

◎ Precautions for servicing control box

1. Before service inspection, be sure to measure the power supply terminal (X1M) with a multimeter and confirm the power supply is turned off.
2. Be careful not to touch the high-temperature components.
There is a possibility that each component within the control box can generate high temperature.
3. Be careful not to touch the live parts.
Do not touch the live parts before making sure the residual voltage is less than 50V.
 - ① After turning off the power supply, leave the units unused for 10 minutes.
 - ② To prevent a damage of the PC board, always touch the ground terminal with your hands to discharge the static electricity on your body.
 - ③ Do not touch the live parts. Measure the residual voltage of the measuring position using the multimeter.
 - ④ After confirming the residual voltage, pull out the connector for the fan motor in the outdoor unit immediately. (If the fan in the outdoor unit rotates by strong headwinds, it may cause storage of electricity in the capacitor and electric shock.)

※ After completing service work, plug in the connector for the fan motor in the outdoor unit.

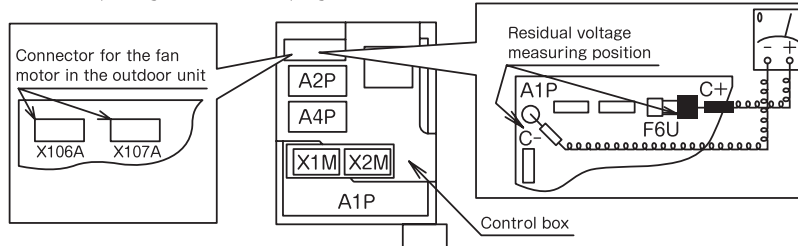

Precautions to Cool/Heat remote controller wiring

- The setting should be carried out only when the changeover of Cool/Heat is set by the remote controller installed in the outdoor unit.
- ① Wire the Cool/Heat changeover remote controller (optional accessory) to the terminals (A, B and C) on the PC board (A4P) of the outdoor unit.
 - ② Set the Cool/Heat changeover setting switch DSI-1 on the PC board (A2P) of the outdoor unit from IN (factory setting) to OUT.

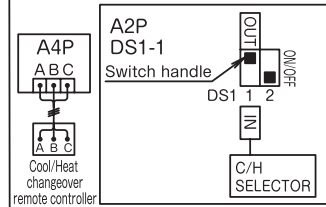

If you get confused in the setting process, push the MODE button (BS1) to return to the [SETTING MODE 1] (H1P: Light OFF).

(The LED display on the left side shows the factory setting state)

LED display ● : Light OFF ☀ : Light ON ⚡ : Flashing * : Light ON or Light OFF

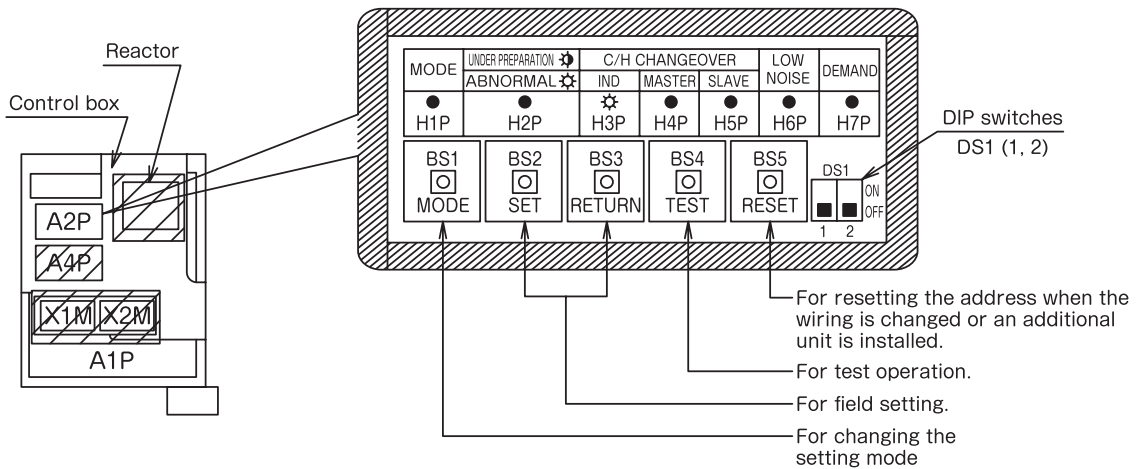

⚠ When performing the operations such as inspection, to prevent electric shocks, protect the shaded area of the electrical components using the insulating tape.

Changing the setting mode

The setting mode can be changed by the MODE button (BS1) according to the following procedure.

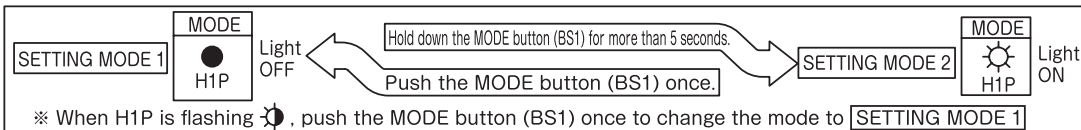

⚠ Caution

For selecting low noise operation by an outside order, demand operation and operation mode setting with a Cool/Heat central remote controller, the external control adapter for outdoor unit (optional accessory) is required. For details, see the instruction attached to the adapter.

Make settings (Cool/Heat selection setting) in the SETTING MODE 1 (H1P: Light OFF)

Setting procedure	Description	Example of LED display and its position						
		H1P	H2P	H3P	H4P	H5P	H6P	H7P
① Push the SET button (BS2) and adjust the LED display to the example shown on the right.	When setting Cool/Heat selection for each outdoor system individually (factory setting)	●	●	☀	●	●	●	●
	For the master unit, when setting Cool/Heat selection for multiple outdoor systems together ※	●	●	☀	☀	●	●	●
	For the slave unit, when setting Cool/Heat selection for multiple outdoor systems together ※	●	●	☀	●	☀	●	●
② Push the RETURN button (BS3) to define the setting.								

Items marked “※” mean the external control adapter (optional accessory) for the outdoor unit should be configured separately. See the operation manual of the adapter for details.

Make settings in the SETTING MODE 2 (H1P: Light ON)

Settings of the following items (A ~ F) can be carried out.

Setting procedure	Details of setting	Example of LED display and its position							
		H1P	H2P	H3P	H4P	H5P	H6P	H7P	
① Push the SET button (BS2) and adjust the LED display to the example shown on the right according to the required setting (A ~ F).	(A) Additional refrigerant charging operation setting	☀	●	☀	●	☀	●	●	
	(B) Refrigerant recovery/Evacuation mode setting	☀	●	☀	●	☀	●	☀	
	(C) Night-time automatic low noise setting	☀	●	☀	●	☀	●	●	
	(D) External low noise standard setting	☀	●	☀	☀	●	●	☀	
	(E) Demand standard setting	☀	●	☀	☀	☀	●	●	
	(F) External low noise demand setting	☀	●	●	☀	☀	●	●	
② Push the RETURN button (BS3) to indicate the present setting. (Refer to ③)									
③ Setting values For (A) (B) (F) -- ON and OFF For (C) -- OFF, Level 1~3 For (D) (E) -- Level 1~3 Push the SET button (BS2) and adjust the LED display to the example shown on the right according to the above required setting. ※ For (C) and (D), operation noise: Level 1 > Level 2 > Level 3 For (E), power consumption: Level 1 < Level 2 < Level 3 (See the service manual for details.)	(A) (B)	ON	☀	●	●	●	●	☀	
	(F)	OFF (Factory setting)	☀	●	●	●	●	☀	
	(C)	OFF (Factory setting)	☀	●	●	●	●	●	☀
		Level 1	☀	●	●	●	●	●	☀
		Level 2	☀	●	●	●	●	●	☀
	(D) (E)	Level 3	☀	●	●	●	●	●	☀
		Level 1	☀	●	●	●	●	●	☀
Level 2 (Factory setting)		☀	●	●	●	●	●	☀	
Level 3	☀	●	●	●	●	●	☀		
④ Push the RETURN button (BS3) to define the setting. (Light ON instead of flashing for H1P.)									
⑤ Push the RETURN button (BS3) again to start the operation according to the setting.									

※ For settings other than the above, see the service manual.

Confirmation of setting items The following items can be confirmed in the **SETTING MODE 1**.

Confirming items	Example of LED display	Example of LED display and its position						
		H1P	H2P	H3P	H4P	H5P	H6P	H7P
The present operating state	● :Normal ☀ :Abnormal ☀ :Under preparation or check operation	●	●	☀	●	●	●	●
Cool/Heat selection setting	When setting Cool/Heat selection for each outdoor system individually (factory setting)	●	●	☀	●	●	●	●
	For the master unit, when setting Cool/Heat selection for multiple outdoor systems together	●	●	☀	☀	●	●	●
	For the slave unit, when setting Cool/Heat selection for multiple outdoor systems together	●	●	☀	●	☀	●	●
Low noise operating state	● Under normal operation (factory setting) ☀ Under low noise operation	●	●	☀	●	●	●	●
Demand operating state	● Under normal operation (factory setting) ☀ Under demand operation	●	●	☀	●	●	●	●

Precautions for test operation

※ After the power supply is turned on, do not operate the air conditioner before the UNDER PREPARATION (H2P) indicator is OFF (maximum for 12 minutes).

- Check the stop valves. Make sure to completely open the stop valve on the gas side and the stop valve on the liquid side.
- Make sure to carry out test operation after the first installation. Otherwise, the malfunction code "U3" will be displayed and normal operation cannot be carried out.

- ① To protect the compressor, make sure to turn on the power supply for 6 hours before starting operation.
- ② Enter the **SETTING MODE 1** (H1P: Light OFF).
- ③ In the stopped status, hold down the TEST button (BS4) for more than 5 seconds to start test operation.

(H2P will flash up and "Test Operation" and **CENTRAL CONTROL** will be displayed in the remote controller.)
 It may take about 10 minutes to bring the state of refrigerant stable before the compressor starts, but this is not malfunction.

Test operation is automatically carried out in the cooling mode.

(※ The refrigerant running sound or the magnetic sound of a solenoid valve may become loud during this operation.)

Following items can be automatically checked.

- Incorrect wiring checking
- Unopened stop valve checking
- Piping length auto determination

To discontinue the operation, push the RETURN button (BS3). The system will stop after operation for 30 seconds around.

(During the test operation, it is impossible to stop the unit from the remote controller.)

- ④ Close the front panel.
- ⑤ The system will stop automatically after running 30 minutes around (maximum 1 hour). Check the operation results by the outdoor unit LED display.

<See the table shown below>

	H1P	H2P	H3P	H4P	H5P	H6P	H7P
Normal	●	●	☀	●	●	●	●
Abnormal	●	☀	☀	●	●	●	●

< Caution >

- After the operation is finished, start the normal operation from the remote controller and check.
- The LED display will change during this operation, but this is not malfunction.
- To prevent electric shock during this operation, install the front panel firmly.

[Measures for abnormal finish]

1. Confirm the malfunction code by the remote controller.
2. Correct the abnormality. (See the installation manual, operation manual or service manual, or contact your dealer.)
3. After correcting the abnormality, push the RETURN button (BS3) to reset the malfunction code.
4. Carry out the test operation again and confirm the abnormality is properly corrected.

※ If there is no malfunction code displayed in the remote controller, the system will carry out normal operation after about 5 minutes.

Precautions to service mode operation

※ After turning on the power supply, the unit can not start service mode until H2P goes off (maximum for 12 minutes around).

• **For internal evacuation** (At the first installation, this internal evacuation is not required. It is only required for service.)

- ① When the unit is at standstill, set Ⓑ Refrigerant recovery/Evacuation mode to ON in the **SETTING MODE 2**.
(After the setting is defined, do not reset the **SETTING MODE 2** until the evacuation is completed.)
(If "Test Operation" and **CENTRAL CONTROL** are displayed in the remote controller, the operation will be rejected.)
- ② Evacuate the system with a vacuum pump.
- ③ Push the MODE button (BS1) to reset the **SETTING MODE 2**.

• **For refrigerant recovery by refrigerant reclaimer**

- ① When the unit is at standstill, set Ⓑ Refrigerant recovery/Evacuation mode to ON in the **SETTING MODE 2**.
(The expansion valves in the indoor and outdoor units will be opened completely. Some of the solenoid valves are ON.)
(If "Test Operation" and **CENTRAL CONTROL** are displayed in the remote controller, the operation will be rejected.)
- ② Recover the refrigerant by a refrigerant reclaimer in accordance with the local laws and regulations.
- ③ Push the MODE button (BS1) to reset the **SETTING MODE 2**.

Caution Do not shut off the power supply of the outdoor unit when recovering the refrigerant.
(Otherwise, the solenoid valves will be closed and the refrigerant of the outdoor unit can not be recovered.)

Precautions for charging additional refrigerant

※ When the outdoor unit is stopped and the entire quantity of refrigerant can not be charged, make sure to charge the remaining quantity of refrigerant using this procedure. Otherwise, the unit may malfunction.

- ① Turn on the power supply of the indoor unit and outdoor unit.
- ② Completely open the stop valve on the gas side and the stop valve on the liquid side.
- ③ Connect the service port to the charge hose (gas stop valve).
- ④ When the unit is at standstill and under the **SETTING MODE 2** (H1P: Light ON), set Ⓐ "Additional refrigerant charging mode" to "ON".
- ⑤ The operation is automatically started. (H2P flickers, and "Test Operation" and **CENTRAL CONTROL** are displayed in the remote controller.)
- ⑥ After charging the specified quantity of refrigerant, push the RETURN button (BS3) to stop the operation.

(The operation is stopped within 30 minutes around.
If refrigerant charging is not completed within 30 minutes, set Ⓐ "Additional refrigerant charging mode" to ON and perform this operation again.
If this operation is stopped soon after restarting, the refrigerant may be overcharged. Stop charging extra refrigerant.)

- ⑦ Disconnect the refrigerant charge hose.

1. Record of setting details

After performing settings to Ⓒ ~ Ⓔ in the **SETTING MODE 2**, make a record by marking ○ in the table below.

Ⓒ Night-time automatic low noise setting	Ⓓ External low noise standard setting	Ⓔ Demand standard setting
OFF Level 1 Level 2 Level 3	Level 1 Level 2 Level 3	Level 1 Level 2 Level 3

(Be sure to fill in the table by the after-sales service staff.)

2. Record of additional refrigerant charging amount

Refrigerant equivalent to 25ft. (7.6m) liquid piping is factory-charged in the outdoor unit. Calculate the refrigerant charging amount based on the following formula.

• If the liquid piping length is 25ft. (7.6m) or less (lbs)

indoor unit type	Additional refrigerant charging amount [A]	indoor unit type	Additional refrigerant charging amount [A]
FAQ,FBQ18	0.15	FCQ18,24	0.36
FBQ24	0.20	FTQ18,24	0.46

• If the liquid piping length is more than 25ft. (7.6m)

$$\frac{[A]}{\text{lbs}} + \frac{(\text{Liquid piping length}-25) \text{ ft.} \times 0.036}{\text{lbs}} = \frac{\text{Additional refrigerant charging amount}}{\text{lbs}}$$

3. Record of indoor unit model name and installation location

Model name	
Installation location	

15.2 RZR30 - 48TBVJUA, RZQ30 - 48TBVJUA

Service precautions



Warning



Caution to electric shock

◎ Precautions for servicing control box

1. Before service inspection, be sure to measure the power supply terminal (X1M) with a multimeter and confirm the power supply is turned off.
2. Be careful not to touch the high-temperature components.
There is a possibility that each component within the control box can generate high temperature.
3. Be careful not to touch the live parts.
Do not touch the live parts before making sure the residual voltage is less than 50V.
 - ① After turning off the power supply, leave the units unused for 10 minutes.
 - ② To prevent a damage of the PC board, always touch the ground terminal with your hands to discharge the static electricity on your body.
 - ③ Do not touch the live parts. Measure the residual voltage of the measuring position using the multimeter.
 - ④ After confirming the residual voltage, pull out the connector for the fan motor in the outdoor unit immediately.
(If the fan in the outdoor unit rotates by strong headwinds, it may cause storage of electricity in the capacitor and electric shock.)

※ After completing service work, plug in the connector for the fan motor in the outdoor unit, then restore the insulating film to its state as delivered.

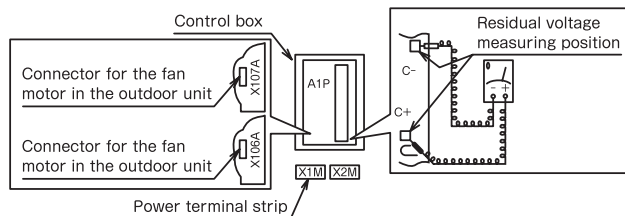

LED display ● : Light OFF ☀ : Light ON ⚡ : Flashing * : Light ON or Light OFF

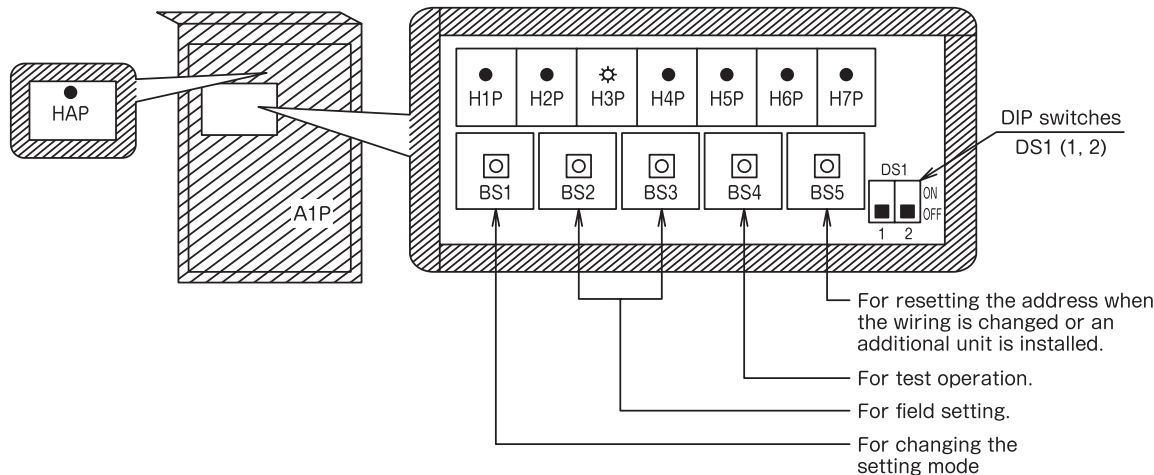

⚠ While performing check and other operations, do not uncover the insulating film or remove the P board protective cover to avoid electric shock and injury!

Changing the setting mode

The setting mode can be changed by the MODE button (BS1) according to the following procedure.

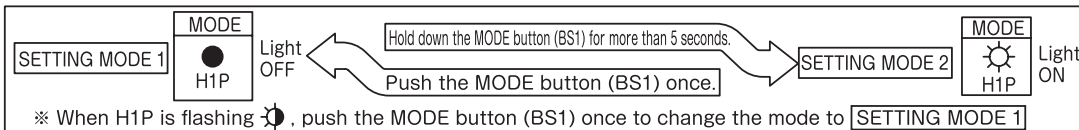

< Caution >

For selecting low noise operation by an outside order, demand operation and operation mode setting with a Cool/Heat central remote controller, the external control adapter for outdoor unit (optional accessory) is required. For details, see the instruction attached to the adapter.

Make settings (Cool/Heat selection setting) in the SETTING MODE 1 (H1P: Light OFF)

Setting procedure	Description	Example of LED display and its position						
		H1P	H2P	H3P	H4P	H5P	H6P	H7P
① Push the SET button (BS2) and adjust the LED display to the example shown on the right.	When setting Cool/Heat selection for each outdoor system individually (factory setting)	●	●	☀	●	●	●	●
	For the master unit, when setting Cool/Heat selection for multiple outdoor systems together ※	●	●	☀	☀	●	●	●
	For the slave unit, when setting Cool/Heat selection for multiple outdoor systems together ※	●	●	☀	●	☀	●	●
② Push the RETURN button (BS3) to define the setting.								

Items marked “※” mean the external control adapter (optional accessory) for the outdoor unit should be configured separately. See the operation manual of the adapter for details.

Make settings in the SETTING MODE 2 (H1P: Light ON)

Settings of the following items (A ~ F) can be carried out.

Setting procedure	Details of setting	Example of LED display and its position							
		H1P	H2P	H3P	H4P	H5P	H6P	H7P	
① Push the SET button (BS2) and adjust the LED display to the example shown on the right according to the required setting (A ~ F).	(A) Additional refrigerant charging operation setting	☀	●	☀	●	☀	●	●	
	(B) Refrigerant recovery/Evacuation mode setting	☀	●	☀	●	☀	●	☀	
	(C) Night-time automatic low noise setting	☀	●	☀	●	☀	●	●	
	(D) External low noise standard setting	☀	●	☀	☀	●	●	☀	
	(E) Demand standard setting	☀	●	☀	☀	☀	●	●	
	(F) External low noise demand setting	☀	●	●	☀	☀	●	●	
② Push the RETURN button (BS3) to indicate the present setting. (Refer to ③)									
③ Setting values For (A) (B) (F) -- ON and OFF For (C) -- OFF, Level 1~3 For (D) (E) -- Level 1~3 Push the SET button (BS2) and adjust the LED display to the example shown on the right according to the above required setting. ※ For (C) and (D), operation noise: Level 1 > Level 2 > Level 3 For (E), power consumption: Level 1 < Level 2 < Level 3 (See the service manual for details.)	(A) (B)	ON	☀	●	●	●	●	☀	
	(F)	OFF (Factory setting)	☀	●	●	●	●	☀	
	(C)	OFF (Factory setting)	☀	●	●	●	●	●	☀
		Level 1	☀	●	●	●	●	●	☀
		Level 2	☀	●	●	●	●	☀	●
	(D) (E)	Level 3	☀	●	●	●	●	☀	☀
		Level 1	☀	●	●	●	●	●	☀
Level 2 (Factory setting)		☀	●	●	●	●	☀	●	
Level 3	☀	●	●	●	☀	●	●		
④ Push the RETURN button (BS3) to define the setting. (Light ON instead of flashing for H1P.)									
⑤ Push the RETURN button (BS3) again to start the operation according to the setting.									

※ For settings other than the above, see the service manual.

Confirmation of setting items The following items can be confirmed in the SETTING MODE 1.

Confirming items	Example of LED display	Example of LED display and its position						
		H1P	H2P	H3P	H4P	H5P	H6P	H7P
The present operating state	● :Normal ☀ :Abnormal ☀ :Under preparation or check operation	●	●	☀	●	●	●	●
Cool/Heat selection setting	When setting Cool/Heat selection for each outdoor system individually (factory setting)	●	●	☀	●	●	●	●
	For the master unit, when setting Cool/Heat selection for multiple outdoor systems together	●	●	☀	☀	●	●	●
	For the slave unit, when setting Cool/Heat selection for multiple outdoor systems together	●	●	☀	●	☀	●	●
Low noise operating state	● Under normal operation (factory setting) ☀ Under low noise operation	●	●	☀	●	●	●	●
Demand operating state	● Under normal operation (factory setting) ☀ Under demand operation	●	●	☀	●	●	●	●

Precautions for test operation

※ After the power supply is turned on, do not operate the air conditioner before the UNDER PREPARATION (H2P) indicator is OFF (maximum for 12 minutes).

- Check the stop valves. Make sure to completely open the stop valve on the gas side and the stop valve on the liquid side.
- Make sure to carry out test operation after the first installation. Otherwise, the malfunction code "U3" will be displayed and normal operation cannot be carried out.
- ① To protect the compressor, make sure to turn on the power supply for 6 hours before starting operation.
- ② Enter the **SETTING MODE 1** (H1P: Light OFF).
- ③ In the stopped status, hold down the TEST button (BS4) for more than 5 seconds to start test operation.

(H2P will flash up and "Test Operation" and **CENTRAL CONTROL** will be displayed in the remote controller.)
 (It may take about 10 minutes to bring the state of refrigerant stable before the compressor starts, but this is not malfunction.)

Test operation is automatically carried out in the cooling mode.

(※ The refrigerant running sound or the magnetic sound of a solenoid valve may become loud during this operation.)

Following items can be automatically checked.

- Incorrect wiring checking
- Unopened stop valve checking
- Piping length auto determination

To discontinue the operation, push the RETURN button (BS3). The system will stop after operation for 30 seconds around.

(During the test operation, it is impossible to stop the unit from the remote controller.)

- ④ Close the front panel.
- ⑤ The system will stop automatically after running 30 minutes around (maximum 1 hour). Check the operation results by the outdoor unit LED display.

<See the table shown below>

	H1P	H2P	H3P	H4P	H5P	H6P	H7P
Normal	●	●	☀	●	●	●	●
Abnormal	●	☀	☀	●	●	●	●

< Caution >

- After the operation is finished, start the normal operation from the remote controller and check.
- The LED display will change during this operation, but this is not malfunction.
- To prevent electric shock during this operation, install the front panel firmly.

[Measures for abnormal finish]

1. Confirm the malfunction code by the remote controller.
2. Correct the abnormality. (See the installation manual, operation manual or service manual, or contact your dealer.)
3. After correcting the abnormality, push the RETURN button (BS3) to reset the malfunction code.
4. Carry out the test operation again and confirm the abnormality is properly corrected.

※ If there is no malfunction code displayed in the remote controller, the system will carry out normal operation after about 5 minutes.

Precautions to service mode operation

※ After turning on the power supply, the unit can not start service mode until H2P goes off (maximum for 12 minutes around).

• **For internal evacuation** (At the first installation, this internal evacuation is not required. It is only required for service.)

- ① When the unit is at standstill, set Ⓑ Refrigerant recovery/Evacuation mode to ON in the **SETTING MODE 2**.
(After the setting is defined, do not reset the **SETTING MODE 2** until the evacuation is completed.)
(If "Test Operation" and **CENTRAL CONTROL** are displayed in the remote controller, the operation will be rejected.)
- ② Evacuate the system with a vacuum pump.
- ③ Push the MODE button (BS1) to reset the **SETTING MODE 2**.

• **For refrigerant recovery by refrigerant reclaimer**

- ① When the unit is at standstill, set Ⓑ Refrigerant recovery/Evacuation mode to ON in the **SETTING MODE 2**.
(The expansion valves in the indoor and outdoor units will be opened completely. Some of the solenoid valves are ON.)
(If "Test Operation" and **CENTRAL CONTROL** are displayed in the remote controller, the operation will be rejected.)
- ② Recover the refrigerant by a refrigerant reclaimer in accordance with the local laws and regulations.
- ③ Push the MODE button (BS1) to reset the **SETTING MODE 2**.

Caution Do not shut off the power supply of the outdoor unit when recovering the refrigerant.
(Otherwise, the solenoid valves will be closed and the refrigerant of the outdoor unit can not be recovered.)

Precautions for charging additional refrigerant

※ When the outdoor unit is stopped and the entire quantity of refrigerant can not be charged, make sure to charge the remaining quantity of refrigerant using this procedure. Otherwise, the unit may malfunction.

- ① Turn on the power supply of the indoor unit and outdoor unit.
- ② Completely open the stop valve on the gas side and the stop valve on the liquid side.
- ③ Connect the service port (for additionally charging the refrigerant) to the charge hose.
- ④ When the unit is at standstill and under the **SETTING MODE 2** (H1P: Light ON), set Ⓐ "Additional refrigerant charging mode" to "ON".
- ⑤ The operation is automatically started. (H2P flickers, and "Test Operation" and **CENTRAL CONTROL** are displayed in the remote controller.)
- ⑥ After charging the specified quantity of refrigerant, push the RETURN button (BS3) to stop the operation.
(The operation is stopped within 30 minutes around.
If refrigerant charging is not completed within 30 minutes, set Ⓐ "Additional refrigerant charging mode" to ON and perform this operation again.
If this operation is stopped soon after restarting, the refrigerant may be overcharged. Stop charging extra refrigerant.)
- ⑦ Disconnect the refrigerant charge hose.

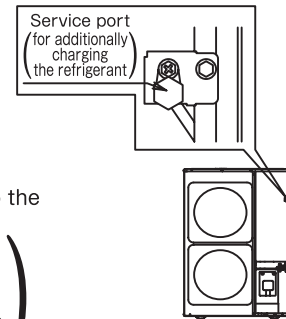

1. Record of setting details

After performing settings to Ⓒ ~ Ⓔ in the **SETTING MODE 2**, make a record by marking ○ in the table below.

Ⓒ Night-time automatic low noise setting	Ⓓ External low noise standard setting	Ⓔ Demand standard setting
OFF Level 1 Level 2 Level 3	Level 1 Level 2 Level 3	Level 1 Level 2 Level 3

(Be sure to fill in the table by the after-sales service staff.)

2. Record of additional refrigerant charging amount

Refrigerant equivalent to 25ft. (7.6m) liquid piping is factory-charged in the outdoor unit. Calculate the refrigerant charging amount based on the following formula.

• If the liquid piping length is 25ft. (7.6m) or less (lbs)

indoor unit type	Additional refrigerant charging amount [A]	indoor unit type	Additional refrigerant charging amount [A]
FBQ30,36,42,48	0	FTQ30,36	1.07
FCQ30,36,42,48		FTQ42,48	1.41

• If the liquid piping length is more than 25ft. (7.6m)

$$\frac{[A]}{\text{lbs}} + \frac{(\text{Liquid piping length}-25) \text{ ft.} \times 0.036}{\text{lbs}} = \frac{\text{Additional refrigerant charging amount}}{\text{lbs}}$$

3. Record of indoor unit model name and installation location

Model name	
Installation location	

16. Caution for Refrigerant Leaks

16.1 Introduction

Points to note in connection with refrigerant leaks

The installer and system specialist shall secure safety against leakage according to local regulations or standards. The following standards may be applicable if local regulations are not available.

The SPLIT System, like other air conditioning systems, uses R410A as refrigerant. R410A itself is an entirely safe non-toxic, non-combustible refrigerant. Nevertheless care must be taken to ensure that air conditioning facilities are installed in a room which is sufficiently large. This assures that the maximum concentration level of refrigerant gas is not exceeded, in the unlikely event of major leak in the system and this in accordance to the local applicable regulations and standards.

Maximum concentration level

The maximum charge of refrigerant and the calculation of the maximum concentration of refrigerant is directly related to the humanly occupied space in to which it could leak.

The unit of measurement of the concentration is lb./1000 ft.^3 (the weight in lbs. of the refrigerant gas in 1 ft.^3 volume of the occupied space). Compliance to the local applicable regulations and standards for the maximum allowable concentration level is required.

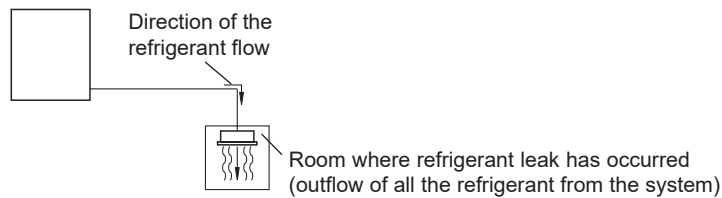

Pay special attention to places, such as basements, etc. where refrigerant can stay, since refrigerant is heavier than air.

16.2 Procedure for Checking Maximum Concentration

Check the maximum concentration level in accordance with steps 1 to 4 below and take whatever action is necessary to comply.

Step 1: Calculate the amount of refrigerant (lbs.) charged to each system separately.

$$\begin{array}{l} \text{Amount of refrigerant in the unit} \\ \text{system (amount of refrigerant with} \\ \text{which the system is charged before} \\ \text{leaving the factory)} \end{array} + \begin{array}{l} \text{Additional charging amount (amount} \\ \text{of refrigerant added locally in} \\ \text{accordance with the length or diameter} \\ \text{of the refrigerant piping and type of} \\ \text{indoor unit)} \end{array} = \begin{array}{l} \text{Total amount of refrigerant (lbs.)} \\ \text{in the system} \end{array}$$



Note:

Where a single refrigerant facility is divided into 2 entirely independent refrigerant systems then use the amount of refrigerant with which each separate system is charged.

Step 2: Calculate a room volume (ft.³)

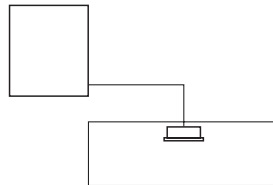

Step 3: Calculating the refrigerant concentration by using the results of the calculations in steps 1 and 2 above.

$$\frac{\text{total amount of refrigerant in the} \\ \text{refrigerant system}}{\text{volume (ft}^3\text{) of the room in which} \\ \text{there is an indoor unit installed}} \leq \text{maximum concen-} \\ \text{tration level (lb./ft}^3\text{)}$$

Step 4: Dealing with the situations where the result exceeds the maximum concentration level.

Where the installation of a facility results in a concentration in excess of the maximum concentration level then it will be necessary to revise the system.

Please consult your dealer.

17. Safety Devices List

17.1 FCQ

Model		FCQ18AAVJU	FCQ24AAVJU	FCQ30AAVJU	FCQ36AAVJU	FCQ42AAVJU	FCQ48AAVJU
Printed circuit board fuse		250 V, 3.15 A	250 V, 3.15 A	250 V, 3.15 A	250 V, 3.15 A	250 V, 3.15 A	250 V, 3.15 A
Fan motor thermal fuse	°F (°C)	—	—	—	—	—	—
Fan motor thermal protector	°F (°C)	—	—	—	—	—	—
Drain pump thermal fuse	°F (°C)	—	—	—	—	—	—

C: 4D140940

17.2 FAQ

Model		FAQ18TAVJU	FAQ24TAVJU
Printed circuit board fuse		250 V, 3.15 A	250 V, 3.15 A
Fan motor thermal fuse	°F	—	—
Fan motor thermal protector	°F	—	—

C: 4D047085D

17.3 FBQ

Model		FBQ18TBVJU	FBQ24TBVJU	FBQ30TBVJU	FBQ36TBVJU	FBQ42TBVJU	FBQ48TBVJU
Printed circuit board fuse		250 V, 3.15 A	250 V, 3.15 A	250 V, 3.15 A	250 V, 3.15 A	250 V, 3.15 A	250 V, 3.15 A
Printed circuit board fuse (fan driver)		250 V, 6.3 A	250 V, 6.3 A	250 V, 6.3 A	250 V, 6.3 A	250 V, 6.3 A	250 V, 6.3 A
Drain pump thermal fuse	°F (°C)	—	—	—	—	—	—

C: 3D140812

17.4 FTQ

Model	FTQ18TAVJUD FTQ18TAVJUA	FTQ24TAVJUD FTQ24TAVJUA	FTQ30TAVJUD FTQ30TAVJUA	FTQ36TAVJUD FTQ36TAVJUA
Printed circuit board fuse (Main)	T, 3.15 A, 250 V	T, 3.15 A, 250 V	T, 3.15 A, 250 V	T, 3.15 A, 250 V
Printed circuit board fuse (Fan)	T, 6.3 A, 250 V	T, 6.3 A, 250 V	T, 6.3 A, 250 V	T, 6.3 A, 250 V
Printed circuit board fuse (Option)	T, 3.15 A, 250 V	T, 3.15 A, 250 V	T, 3.15 A, 250 V	T, 3.15 A, 250 V

C: 3D075604

Model	FTQ42TAVJUD FTQ42TAVJUA	FTQ48TAVJUD FTQ48TAVJUA
Printed circuit board fuse (Main)	T, 3.15 A, 250 V	T, 3.15 A, 250 V
Printed circuit board fuse (Fan)	T, 6.3 A, 250 V	T, 6.3 A, 250 V
Printed circuit board fuse (Option)	T, 3.15 A, 250 V	T, 3.15 A, 250 V

C: 3D075604

18. Fan Performances

18.1 FBQ FBQ18TBVJU

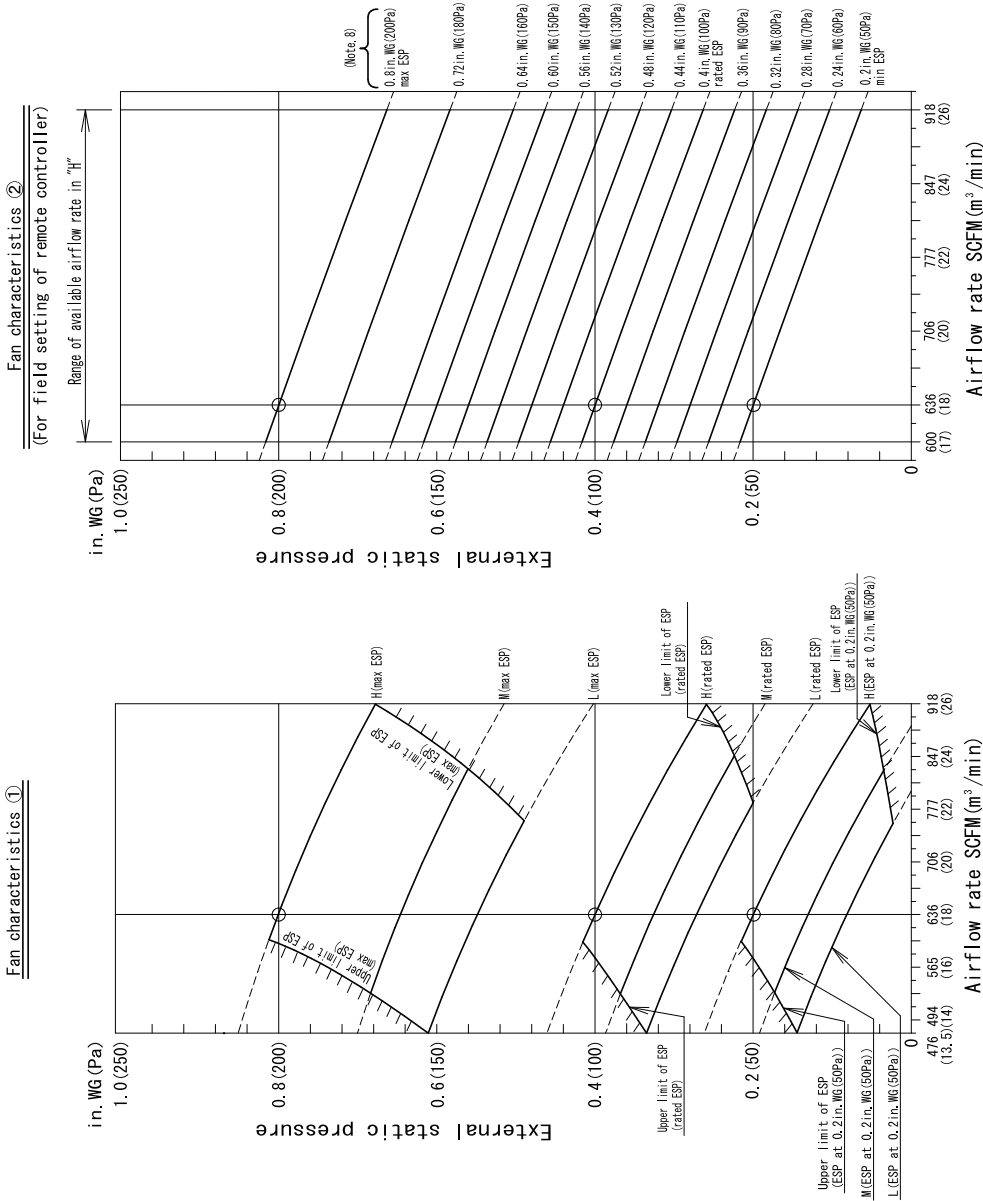

- Notes:
1. Fan characteristics at the time of rear suction and bottom suction are similar.
 2. Fan characteristics ① shows a representative of fan characteristics at the time of "Maximum ESP", "Rated ESP" and "ESP at 0.2 in. WG (50Pa)".
 3. A remote controller can be used to change airflow rate of "H", "M" and "L".
 4. Set ESP on suction side to 0.4 in. WG (100Pa) or less.
 5. Fan characteristics ② (for field setting of remote controller) shows fan characteristics of airflow rate "H" which can be changed in the field setting by a remote controller.
 6. Select ESP setting in accordance with resistance of the connected duct by referring to Fan characteristics ① and ②. (Factory setting of ESP is 0.2 in. WG (100Pa). See installation manual for ESP setting procedure.)
 7. The ESP setting of this unit can be changed into 14 levels.
 8. The value of fan characteristics ② mentioned in this drawing shows ESP at the rated airflow rate.

FBQ24TBVJU

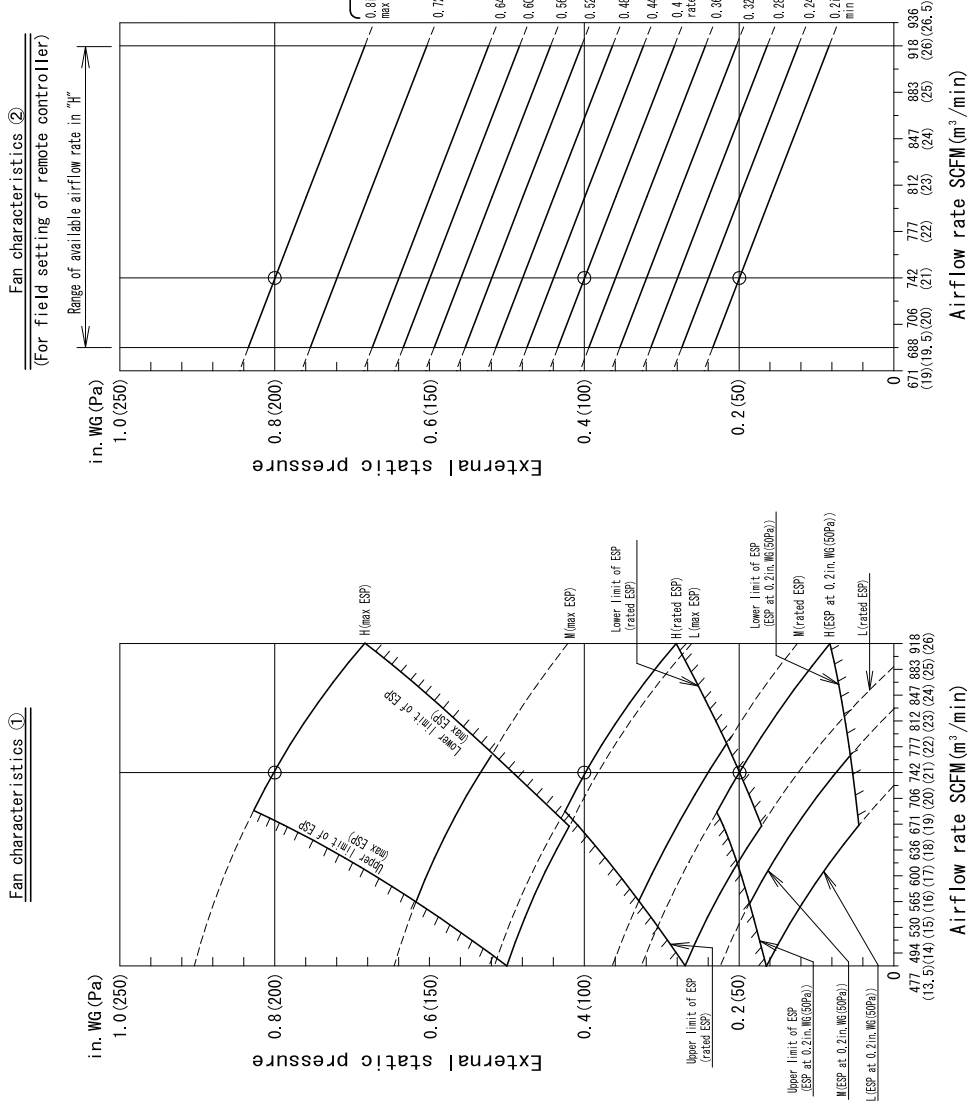

- Notes:
1. Fan characteristics at the time of rear suction and bottom suction are similar.
 2. Fan characteristics ① shows a representative of fan characteristics at the time of "Maximum ESP", "Rated ESP" and "ESP at 0.2 in. WG (50Pa)".
 3. A remote controller can be used to change airflow rate of "H", "M" and "L".
 4. Set ESP on suction side to 0.4 in. WG (100Pa) or less.
 5. Fan characteristics ② (for field setting of remote controller) shows fan characteristics of airflow rate "H" which can be changed in the field setting by a remote controller.
 6. Select ESP setting in accordance with resistance of the connected duct by referring to Fan characteristics ① and ②. (Factory setting of ESP is 0.2 in. WG (100Pa).)
 7. See installation manual for ESP setting procedure.)
 8. The ESP setting of this unit can be changed into 14 levels. The value of fan characteristics ② mentioned in this drawing shows ESP at the rated airflow rate.

3D143367

FBQ30TBVJU

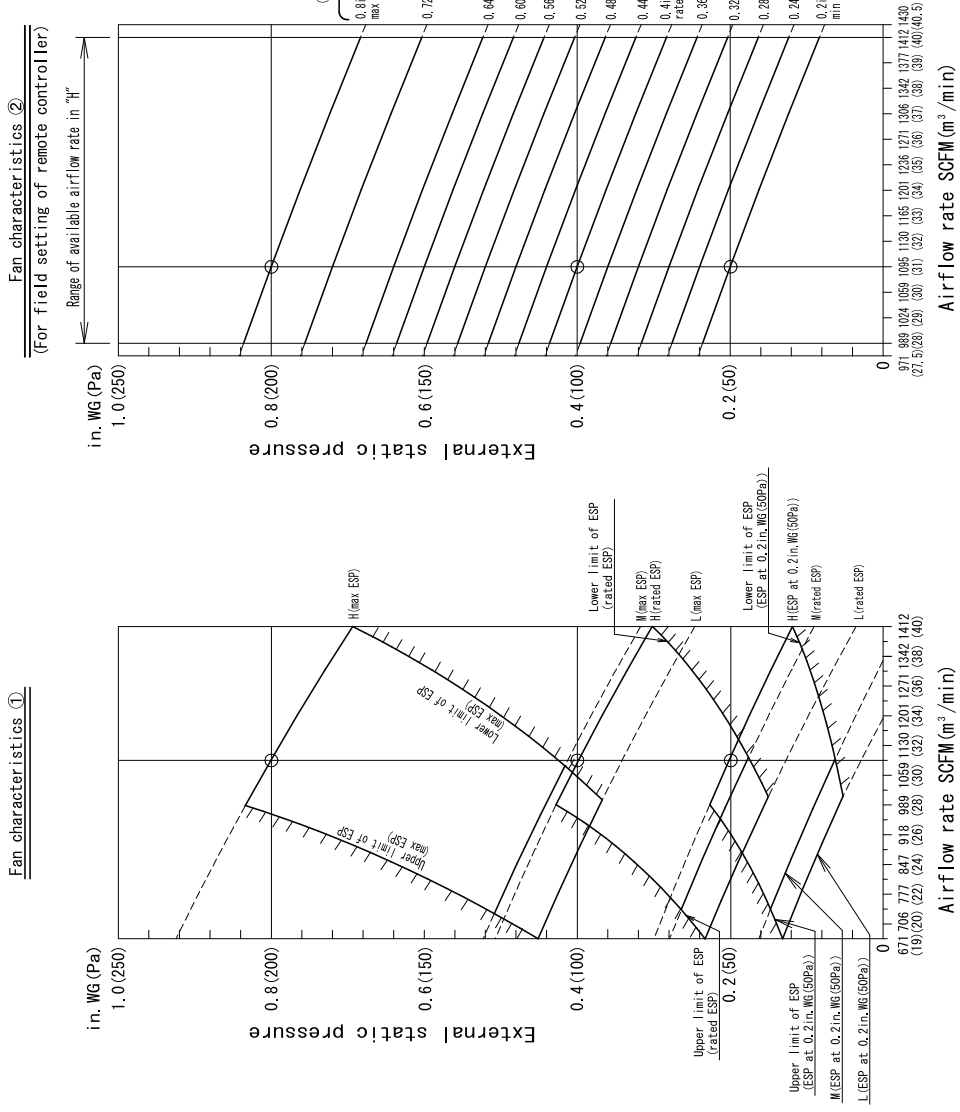

- Notes:
1. Fan characteristics at the time of rear suction and bottom suction are similar.
 2. Fan characteristics ① shows a representative of fan characteristics at the time of "Maximum ESP", "Rated ESP" and "ESP at 0.2 in. WG (50Pa)".
 3. A remote controller can be used to change airflow rate of "H", "M" and "L".
 4. Set ESP on suction side to 0.4 in. WG (100Pa) or less.
 5. Fan characteristics ② (for field setting of remote controller) shows fan characteristics of airflow rate "H" which can be changed in the field setting by a remote controller.
 6. Select ESP setting in accordance with resistance of the connected duct by referring to Fan characteristics ① and ②. (Factory setting of ESP is 0.2 in. WG (100Pa). See installation manual for ESP setting procedure.)
 7. The ESP setting of this unit can be changed into 14 levels.
 8. The value of fan characteristics ② mentioned in this drawing shows ESP at the rated airflow rate.

3D143368

FBQ36TBVJU

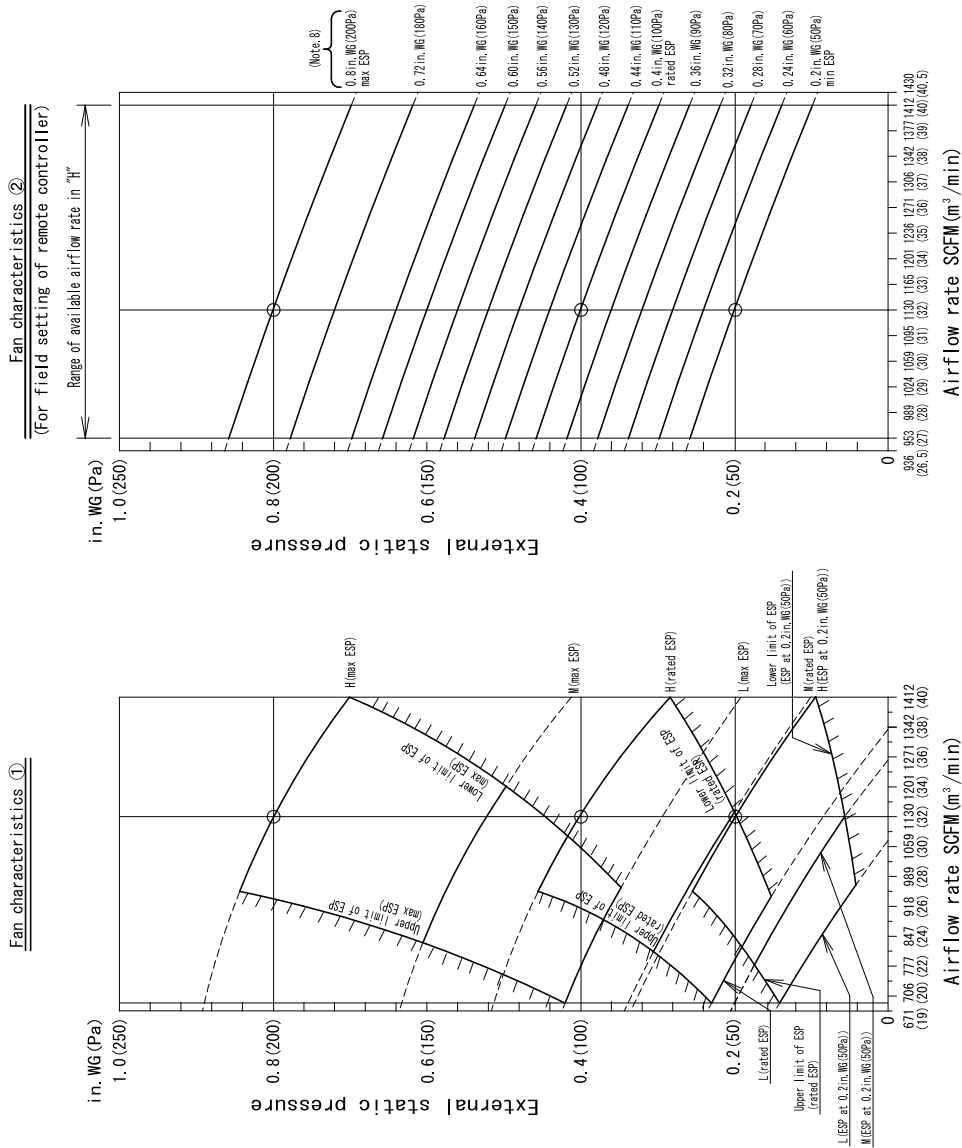

- Notes:
1. Fan characteristics at the time of rear suction and bottom suction are similar.
 2. Fan characteristics ① shows a representative of fan characteristics at the time of "Maximum ESP", "Rated ESP" and "ESP at 0.2 in. WG (50Pa)", "H", "M" and "L".
 3. A remote controller can be used to change airflow rate of "H", "M" and "L".
 4. Set ESP on suction side to 0.4 in. WG (100Pa) or less.
 5. Fan characteristics ② (for field setting of remote controller) shows fan characteristics of airflow rate "H" which can be changed in the field setting by a remote controller.
 6. Select ESP setting in accordance with resistance of the connected duct by referring to Fan characteristics ① and ②. (Factory setting of ESP is 0.2 in. WG (100Pa). See installation manual for ESP setting procedure.)
 7. The ESP setting of this unit can be changed into 14 levels.
 8. The value of fan characteristics ② mentioned in this drawing shows ESP at the rated airflow rate.

FBQ42 - 48TBVJU

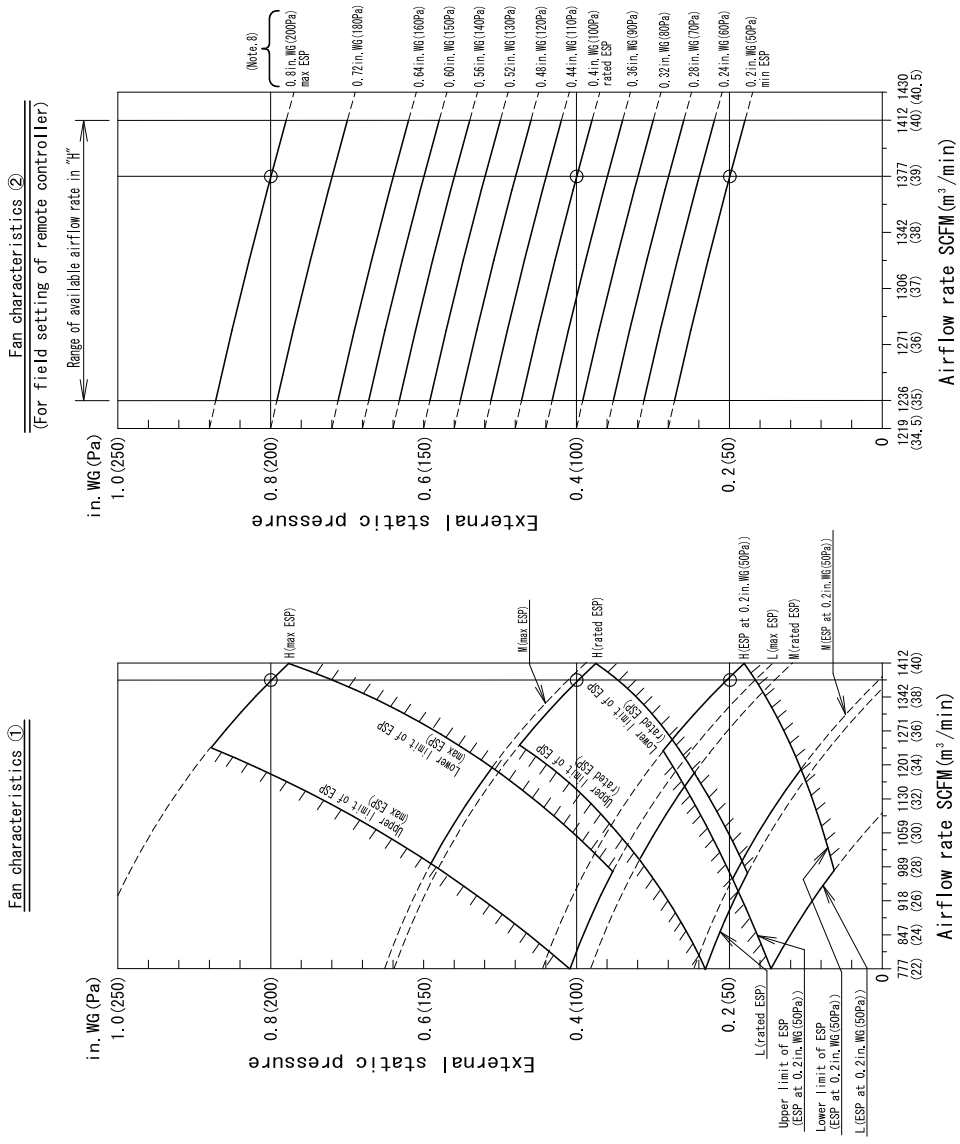

- Notes:
1. Fan characteristics at the time of rear suction and bottom suction are similar.
 2. Fan characteristics ① shows a representative of fan characteristics at the time of "Maximum ESP", "Rated ESP" and "ESP at 0.2 in. WG (50Pa)".
 3. A remote controller can be used to change airflow rate of "H", "M" and "L".
 4. Set ESP on suction side to 0.4 in. WG (100Pa) or less.
 5. Fan characteristics ② (for field setting of remote controller) shows fan characteristics of airflow rate "H" which can be changed in the field setting by a remote controller.
 6. Select ESP setting in accordance with resistance of the connected duct by referring to Fan characteristics ① and ②. (Factory setting of ESP is 0.2 in. WG (100Pa). See installation manual for ESP setting procedure.)
 7. The ESP setting of this unit can be changed into 14 levels.
 8. The value of fan characteristics ② mentioned in this drawing shows ESP at the rated airflow rate.

3D143370

19. Airflow Auto Adjustment Characteristics

19.1 FBQ FBQ18TBVJU

Notes:

1. This indoor unit has the "Airflow automatic adjustment" function, which automatically adjusts the airflow rate so as to be approximately in the range of $\pm 10\%$ of the rated value at the time of installation.
2. After duct construction completion, perform field setting "Airflow automatic adjustment" by remote controller.
3. About the field setting method of the "Airflow automatic adjustment", refer to the installation manual attached to indoor unit.
4. External static pressure that can be adjusted by "Airflow automatic adjustment" function is 0.2 in. WG - 0.8 in. WG (50Pa - 200Pa) (When airflow rate is "H").
5. If the unit is used beyond the range of the above external static pressure, the airflow rate can not be well-adjusted automatically, and the unit will operate with the airflow rate different from the rated value.
6. This figure shows fan characteristics at the time of "H", "M" and "L".
7. The remote controller can be used to change airflow rate of "H", "M" and "L".
8. ESP: External static pressure

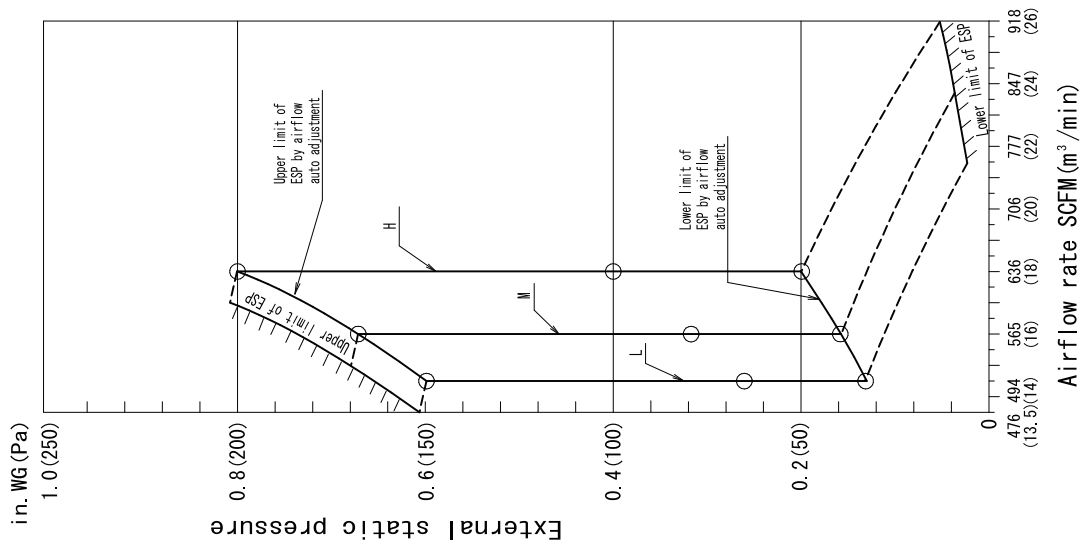

FBQ24TBVJU

- Notes:
1. This indoor unit has the "Airflow automatic adjustment" function, which automatically adjusts the airflow rate so as to be approximately in the range of $\pm 10\%$ of the rated value at the time of installation.
 2. After duct construction completion, perform field setting "Airflow automatic adjustment" by remote controller.
 3. About the field setting method of the "Airflow automatic adjustment", refer to the installation manual attached to indoor unit.
 4. External static pressure that can be adjusted by "Airflow automatic adjustment" function is 0.2in.WG - 0.8in.WG (50Pa - 200Pa) (When airflow rate is "H").
 5. If the unit is used beyond the range of the above external static pressure, the airflow rate can not be well-adjusted automatically, and the unit will operate with the airflow rate different from the rated value.
 6. This figure shows fan characteristics at the time of "H", "M" and "L".
 7. The remote controller can be used to change airflow rate of "H", "M" and "L".
 8. ESP: External static pressure

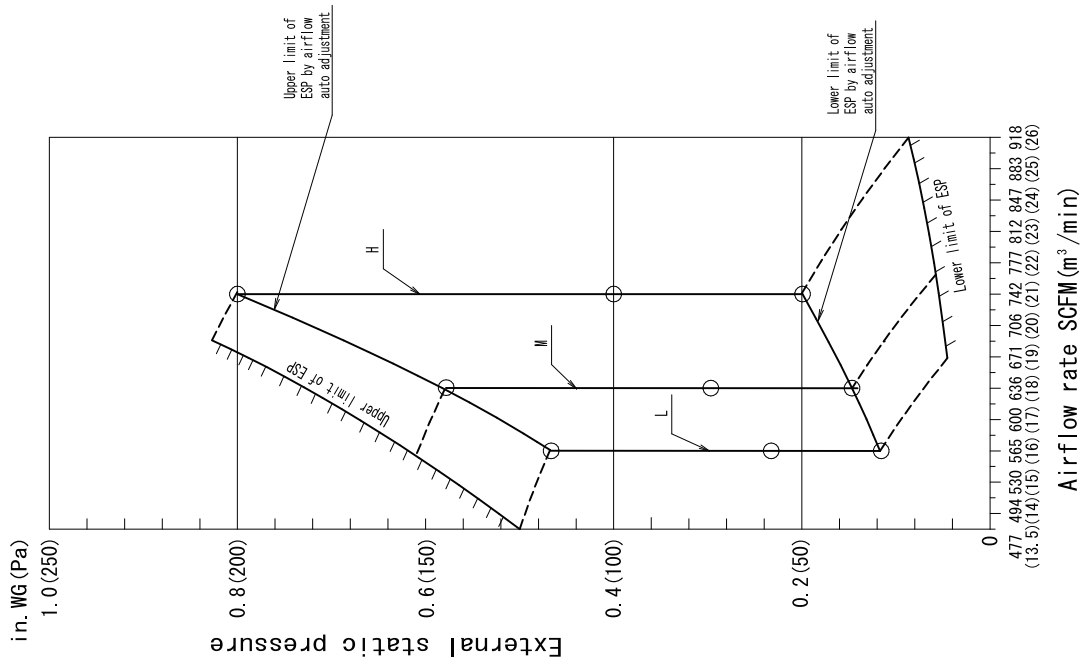

FBQ30TBVJU

Notes:

1. This indoor unit has the "Airflow automatic adjustment" function, which automatically adjusts the airflow rate so as to be approximately in the range of $\pm 10\%$ of the rated value at the time of installation.
2. After duct construction completion, perform field setting "Airflow automatic adjustment" by remote controller.
3. About the field setting method of the "Airflow automatic adjustment", refer to the installation manual attached to indoor unit.
4. External static pressure that can be adjusted by "Airflow automatic adjustment" function is 0.2in.WG - 0.8in.WG (50Pa - 200Pa) (When airflow rate is "H").
5. If the unit is used beyond the range of the above external static pressure, the airflow rate can not be well-adjusted automatically, and the unit will operate with the airflow rate different from the rated value.
6. This figure shows fan characteristics at the time of "H", "M" and "L".
7. The remote controller can be used to change airflow rate of "H", "M" and "L".
8. ESP: External static pressure

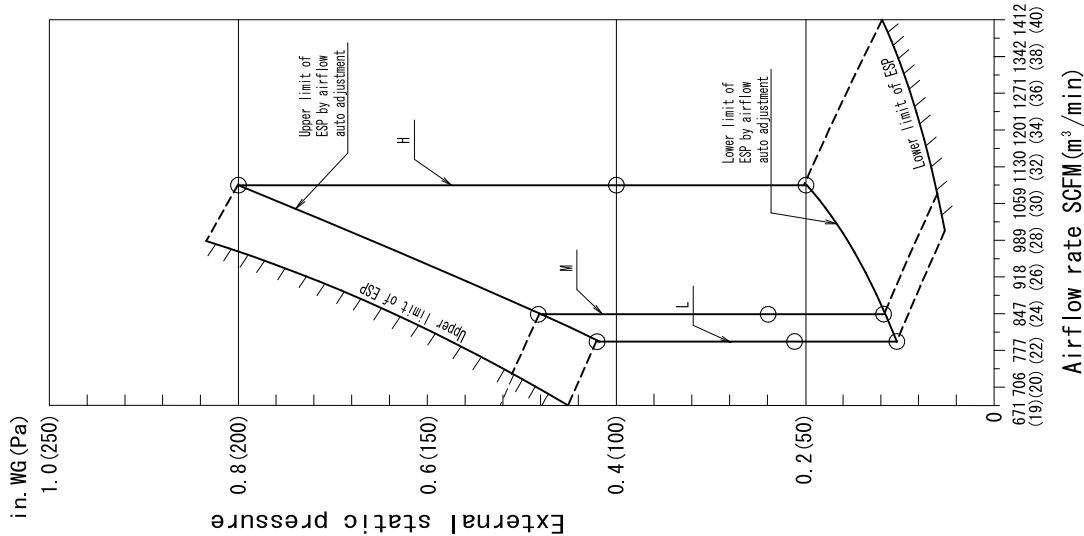

FBQ36TBVJU

Notes:

1. This indoor unit has the "Airflow automatic adjustment" function, which automatically adjusts the airflow rate so as to be approximately in the range of $\pm 10\%$ of the rated value at the time of installation.
2. After duct construction completion, perform field setting "Airflow automatic adjustment" by remote controller.
3. About the field setting method of the "Airflow automatic adjustment", refer to the installation manual attached to indoor unit.
4. External static pressure that can be adjusted by "Airflow automatic adjustment" function is 0.2in.WG - 0.8in.WG (50Pa - 200Pa) (When airflow rate is "H").
5. If the unit is used beyond the range of the above external static pressure, the airflow rate can not be well-adjusted automatically, and the unit will operate with the airflow rate different from the rated value.
6. This figure shows fan characteristics at the time of "H", "M" and "L".
7. The remote controller can be used to change airflow rate of "H", "M" and "L".
8. ESP: External static pressure

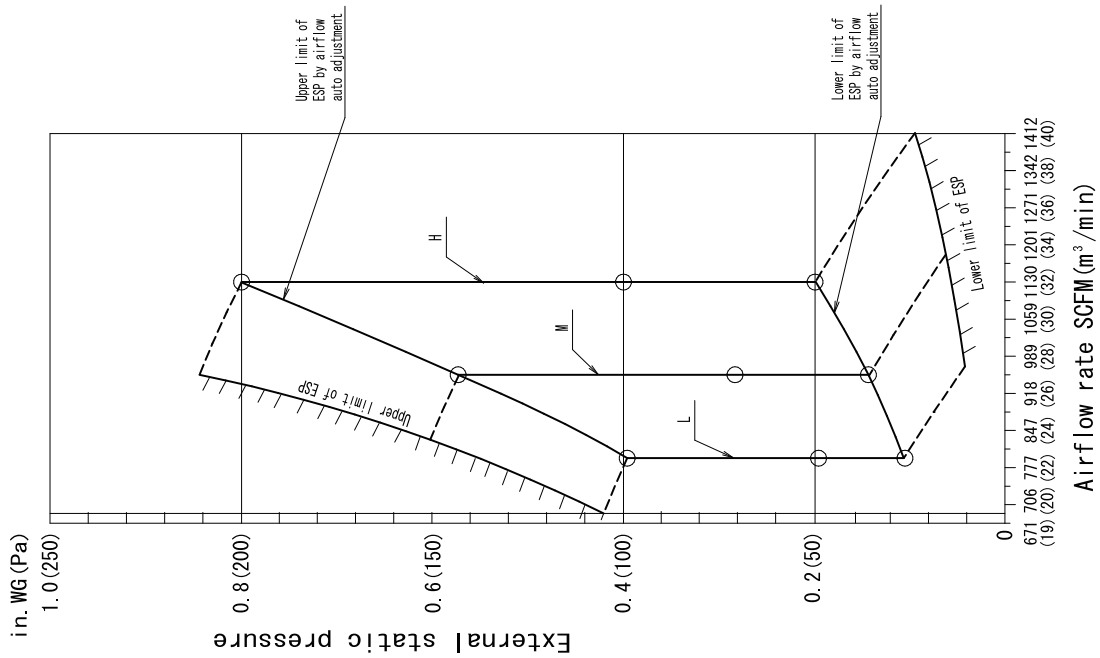

FBQ42 - 48TBVJU

Notes:

1. This indoor unit has the "Airflow automatic adjustment" function, which automatically adjusts the airflow rate so as to be approximately in the range of $\pm 10\%$ of the rated value at the time of installation.
2. After duct construction completion, perform field setting "Airflow automatic adjustment" by remote controller.
3. About the field setting method of the "Airflow automatic adjustment", refer to the installation manual attached to indoor unit.
4. External static pressure that can be adjusted by "Airflow automatic adjustment" function is 0.2in.WG - 0.8in.WG (50Pa - 200Pa) (When airflow rate is "H").
5. If the unit is used beyond the range of the above external static pressure, the airflow rate can not be well-adjusted automatically, and the unit will operate with the airflow rate different from the rated value.
6. This figure shows fan characteristics at the time of "H", "M" and "L".
7. The remote controller can be used to change airflow rate of "H", "M" and "L".
8. ESP: External static pressure

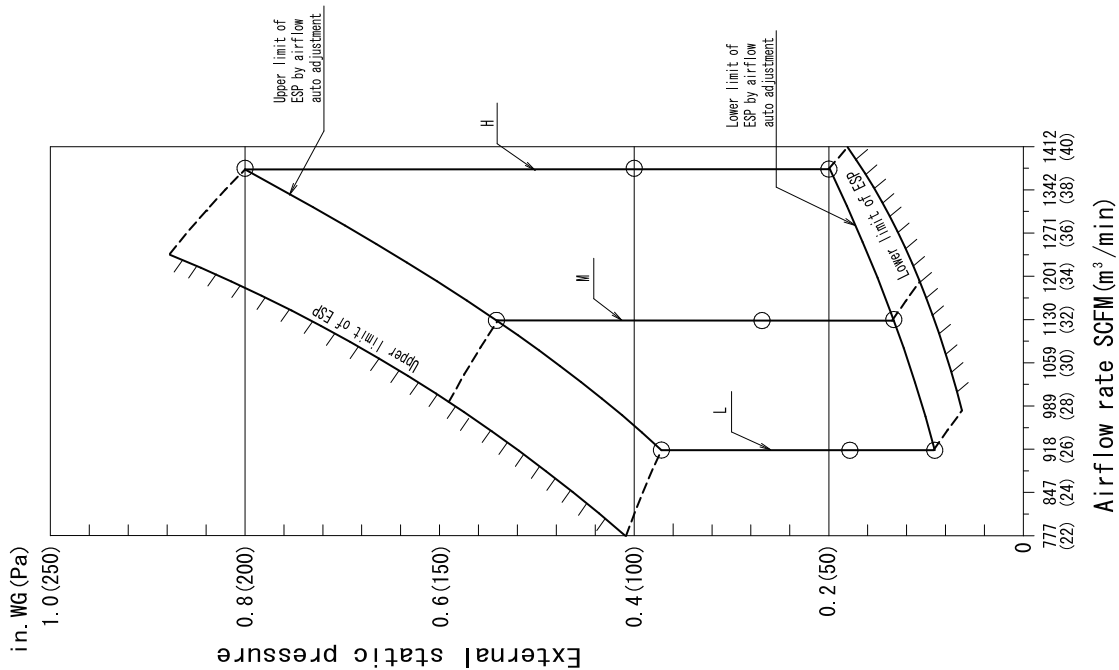

19.2 FTQ
FTQ18TAVJUD
FTQ18TAVJUA

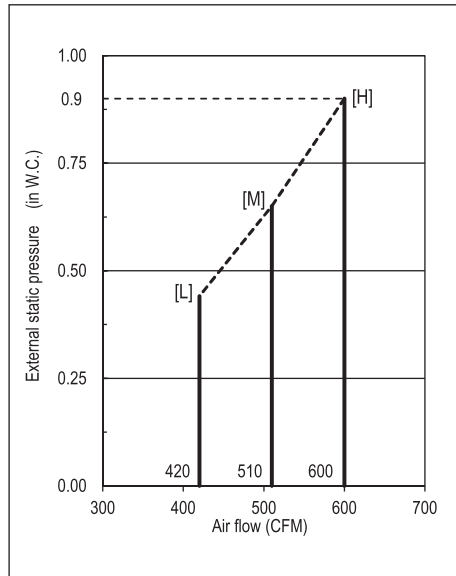

FTQ24TAVJUD
FTQ24TAVJUA

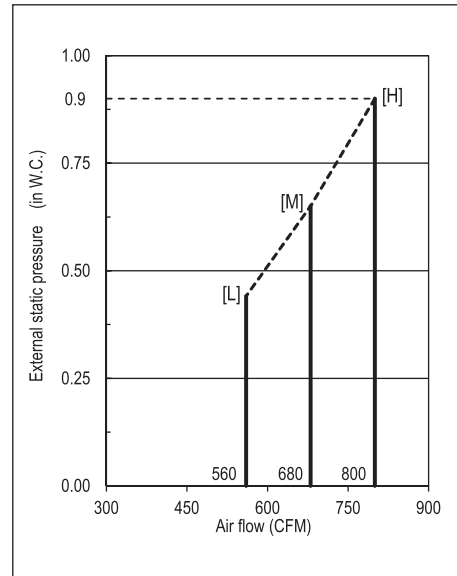

FTQ30TAVJUD
FTQ30TAVJUA

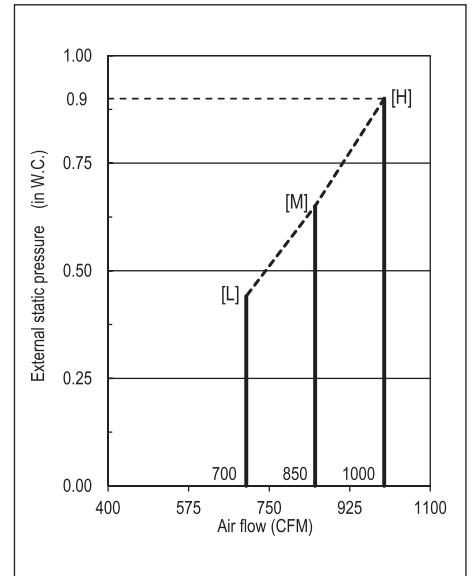

FTQ36TAVJUD
FTQ36TAVJUA

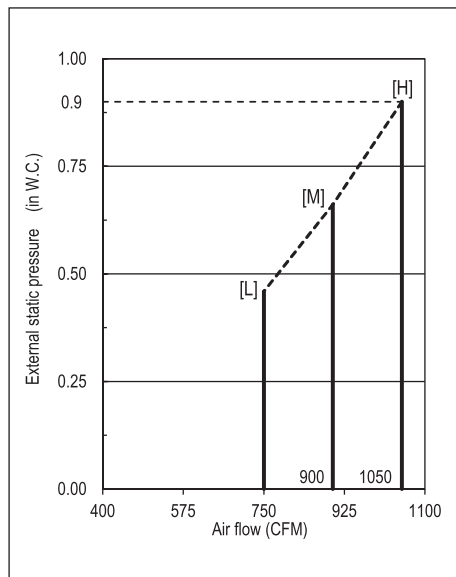

FTQ42TAVJUD
FTQ42TAVJUA

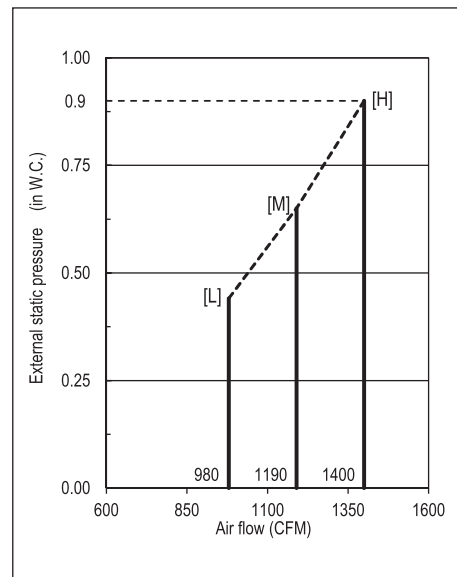

FTQ48TAVJUD
FTQ48TAVJUA

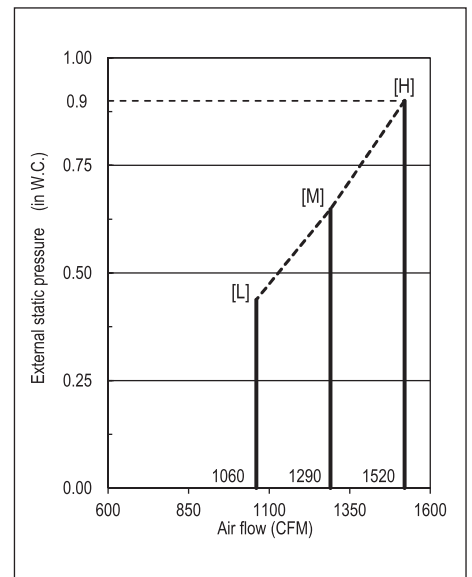

Note:

1. If the airflow is less than 10% of the rated air volume, it is automatically adjusted to the rated air volume.
2. The unit automatically adjusts the external static pressure between 0.0 in. W.C. - 0.9 in. W.C.
3. Airflow cannot operate at the rated value if it is outside the ESP range in the above graph.
4. Fan speed is changeable by using the remote controller.



Warning ● Ask a qualified installer or contractor to install this product. Do not try to install the product yourself.



Improper installation can result in water or refrigerant leakage, electrical shock, fire or explosion.

- Use only those parts and accessories supplied or specified by Daikin. Ask a qualified installer or contractor to install those parts and accessories. Use of unauthorised parts and accessories or improper installation of parts and accessories can result in water or refrigerant leakage, electrical shock, fire or explosion.
- Read the user's manual carefully before using this product. The user's manual provides important safety instructions and warnings. Be sure to follow these instructions and warnings.

If you have any inquiries, please contact your local importer, distributor and/or retailer.

Cautions on product corrosion

1. Air conditioners should not be installed in areas where corrosive gases, such as acid gas or alkaline gas, are produced.
2. If the outdoor unit is to be installed close to the sea shore, direct exposure to the sea breeze should be avoided. If you need to install the outdoor unit close to the sea shore, contact your local distributor.