



SiUS281811EB

R-410A

Service Manual

SkyAir



RZR-TA/TB, RZQ-TA/TB Series

**Cooling Only 60 Hz
Heat Pump 60 Hz**

Introduction	1
1. Safety Cautions	2
1.1 Warnings and Cautions Regarding Safety of Workers	2
1.2 Warnings and Cautions Regarding Safety of Users	4
2. Icons Used	7
3. Revision History	8
Part 1 General Information	9
1. Model Names and Power Supply	10
1.1 Cooling Only	10
1.2 Heat Pump	12
2. External Appearance	14
2.1 Indoor Unit	14
2.2 Outdoor Unit	16
2.3 Remote Controller	17
3. Specifications	18
3.1 Cooling Only	18
3.2 Heat Pump	54
Part 2 Refrigerant Circuit	90
1. Refrigerant Circuit (Piping Diagrams)	91
1.1 Outdoor Unit	91
1.2 Indoor Unit	97
2. Functional Parts Layout	99
2.1 RZR18/24TAVJU, RZQ18/24TAVJU	99
2.2 RZR18/24TAVJUA, RZQ18/24TAVJUA, RZR18/24TBVJUA, RZQ18/24TBVJUA	101
2.3 RZR30-48TAVJU, RZQ30-48TAVJU	103
2.4 RZR30-48TAVJUA, RZQ30-48TAVJUA, RZR30-48TBVJUA, RZQ30-48TBVJUA	105
Part 3 Remote Controller	107
1. Applicable Models	108
2. Names and Functions	109
2.1 BRC1E73	109
2.2 BRC1H71W	112
2.3 Simplified Remote Controller	120
2.4 Wireless Remote Controller	121
3. Main/Sub Setting	123
3.1 Wired Remote Controller (BRC1E73)	123
3.2 Wired Remote Controller (BRC1H71W)	124
3.3 When Wireless Remote Controller is Used Together	126
4. Address Setting for Wireless Remote Controller	127
5. Centralized Control Group No. Setting	130
5.1 BRC1E73	130

5.2	BRC1H71W.....	132
5.3	Wireless Remote Controller	133
6.	Service Settings Menu, Maintenance Menu.....	134
6.1	BRC1E73	134
6.2	Wireless Remote Controller	138
7.	Administrator Menu, Installer Menu	139
7.1	BRC1H71W.....	139

Part 4 Functions and Control 140

1.	Operation Mode	141
2.	Basic Control	142
2.1	Normal Operation	142
2.2	Compressor PI Control	143
2.3	Electronic Expansion Valve PI Control.....	145
2.4	Cooling Operation Fan Control.....	145
3.	Special Control.....	146
3.1	Startup Control	146
3.2	Oil Return Control.....	148
3.3	Defrost Control	150
3.4	Pump Down Residual Control	151
3.5	Restart Standby.....	152
3.6	Stop Control	152
4.	Protection Control	153
4.1	High Pressure Protection Control.....	153
4.2	Low Pressure Protection Control.....	154
4.3	Discharge Pipe Temperature Protection Control.....	155
4.4	Inverter Protection Control	156
5.	Other Control.....	158
5.1	Demand Operation	158
5.2	Heating Operation Prohibition	158
6.	Outline of Control (Indoor Unit)	159
6.1	Remote Controller Thermistor	159
6.2	Thermostat Control.....	161
6.3	Thermostat Control with Operation Mode Set to AUTO	163
6.4	List of Swing Flap Operations	164
6.5	Hot Start Control (In Heating Operation Only).....	165
6.6	Louver Control for Preventing Ceiling Dirt (FCQ Models Only).....	166
6.7	Drain Pump Control.....	167
6.8	Freeze-Up Prevention	169
6.9	Heater Control (Except FTQ-TA Models).....	171
6.10	Heater Control (FTQ-TA Models).....	172
6.11	3-Step Thermostat Processing (FTQ-TA Models).....	175
6.12	Fan Control (Heater Residual) (FTQ-TA Models)	176
6.13	Interlocked with External Equipment (FTQ-TA Models).....	176

Part 5 Field Settings and Test Operation 178

1. Field Setting from Remote Controller	179
1.1 Wired Remote Controller	179
1.2 Simplified Remote Controller	184
1.3 Wireless Remote Controller	185
1.4 List of Field Settings for Indoor Unit	186
1.5 Details of Field Settings for Indoor Unit	190
1.6 Operation Control Mode	205
2. Field Settings from Outdoor Unit	206
2.1 Setting Mode and Monitor Mode	206
2.2 Setting Mode 1	207
2.3 Setting Mode 2	208
2.4 Monitor Mode	212
2.5 Setting of Low Noise Operation and Demand Operation	214
2.6 Setting of Refrigerant Recovery Mode	217
2.7 Setting of Vacuuming Mode	217
2.8 Check Operation	218
2.9 Setting of Auxiliary Heater Control	219
2.10 Setting of Heat Pump Lockout and Emergency Heat Mode	220
3. Test Operation	222
3.1 Check Work Prior to Turning Power Supply ON	222
3.2 Turn Power ON	222
3.3 Test Operation	223
3.4 Error Codes and Corresponding Measures	226
3.5 When Turning ON Power First Time	228
3.6 When Turning ON Power the Second Time and Subsequent	228
3.7 When an Indoor Unit or Outdoor Unit has been Added, or Indoor or Outdoor Unit PCB has been Changed	228

Part 6 Service Diagnosis 229

1. Servicing Items to be Confirmed	232
1.1 Troubleshooting	232
1.2 Precautions for Maintenance	232
1.3 Refrigerant Properties (R-410A)	234
2. Symptom-based Troubleshooting	235
2.1 Indoor Unit Overall	235
2.2 With Infrared Presence/Floor Sensor	238
3. Error Code via Remote Controller	239
3.1 Wired Remote Controller	239
3.2 Wireless Remote Controller	240
4. Error Code Indication by Outdoor Unit PCB	242
5. Troubleshooting by Error Codes	246
5.1 Error Codes and Description	246
5.2 Error Codes - Sub Codes	248
5.3 External Protection Device Abnormality (Except FTQ-TA)	249
5.4 External Protection Device Abnormality (FTQ-TA Only)	250
5.5 Indoor Unit PCB Abnormality	251

5.6	Drain Level Control System (S1L) Abnormality	252
5.7	Indoor Fan Motor (M1F) Lock, Overload	254
5.8	Indoor Fan Motor Abnormality	256
5.9	Blower Motor Not Running	262
5.10	Indoor Fan Motor Status Abnormality	263
5.11	Low Indoor Airflow	264
5.12	Swing Flap Motor Abnormality	265
5.13	Power Supply Voltage Abnormality	267
5.14	Blower Motor Stops for Over/Under Voltage	268
5.15	Electronic Expansion Valve Coil Abnormality, Dust Clogging	269
5.16	Drain Level Above Limit	270
5.17	Self-Cleaning Decoration Panel Abnormality	271
5.18	Defective Capacity Setting	282
5.19	Transmission Abnormality (between Indoor Unit PCB and Fan PCB)	283
5.20	Blower Motor Communication Error	285
5.21	Thermistor Abnormality	286
5.22	Combination Abnormality (between Indoor Unit PCB and Fan PCB)	287
5.23	Blower Motor HP Mismatch	288
5.24	Indoor Blower Does Not Have Required Parameters to Function	289
5.25	Remote Sensor Abnormality	290
5.26	Infrared Presence/Floor Sensor Error	291
5.27	Remote Controller Thermistor Abnormality	296
5.28	Outdoor Main PCB Abnormality	297
5.29	Activation of High Pressure Switch	298
5.30	Activation of Low Pressure Sensor	300
5.31	Compressor Motor Lock	302
5.32	Outdoor Fan Motor Abnormality	304
5.33	Electronic Expansion Valve Coil Abnormality	306
5.34	Discharge Pipe Temperature Abnormality	307
5.35	Refrigerant Overcharged	308
5.36	Thermistor Abnormality	309
5.37	High Pressure Sensor Abnormality	310
5.38	Low Pressure Sensor Abnormality	311
5.39	Inverter PCB Abnormality	312
5.40	Radiation Fin Temperature Rise Abnormality	313
5.41	Compressor Instantaneous Overcurrent	314
5.42	Compressor Overcurrent	315
5.43	Compressor Startup Abnormality	316
5.44	Transmission Error between Microcomputers on Outdoor Unit Main PCB	317
5.45	Inverter Circuit Capacitor High Voltage	318
5.46	Radiation Fin Thermistor Abnormality	319
5.47	Refrigerant Shortage	320
5.48	Power Supply Insufficient or Instantaneous Abnormality	322
5.49	Check Operation Not Executed	324
5.50	Transmission Error between Indoor Units and Outdoor Units	325
5.51	Transmission Error between Remote Controller and Indoor Unit	327
5.52	Transmission Error between Main and Sub Remote Controllers	328

5.53	Transmission Error between Indoor and Outdoor Units in the Same System	329
5.54	Improper Combination of Indoor and Outdoor Units, Indoor Units and Remote Controller	330
5.55	Incorrect Electric Heater Capacity Setting.....	332
5.56	Address Duplication of Centralized Controller.....	333
5.57	Transmission Error between Centralized Controller and Indoor Unit.....	334
5.58	System Not Set	335
5.59	System Abnormality, Refrigerant System Address Undefined	336
6.	Check	337
6.1	High Pressure Check	337
6.2	Low Pressure Check	338
6.3	Superheat Operation Check.....	340
6.4	Power Transistor Check.....	342
6.5	Refrigerant Overcharge Check.....	343
6.6	Refrigerant Shortage Check.....	344
6.7	Vacuumping and Dehydration Procedure	345
6.8	List of Inverter-Related Error Codes.....	346
6.9	Concept of Inverter-Related Error Codes.....	347
6.10	Thermistor Check	348
6.11	Pressure Sensor Check	351
6.12	Broken Wire Check of the Relay Wires	352
6.13	Fan Motor Connector Check	353
6.14	Electronic Expansion Valve Coil Check	355
6.15	Fan Motor Connector Check for FTQ-TA.....	358

Part 7 Appendix..... 362

1.	Wiring Diagrams.....	363
1.1	Outdoor Unit.....	363
1.2	Indoor Unit.....	367

Introduction

1. Safety Cautions.....	2
1.1 Warnings and Cautions Regarding Safety of Workers.....	2
1.2 Warnings and Cautions Regarding Safety of Users.....	4
2. Icons Used	7
3. Revision History	8

1. Safety Cautions

Be sure to read the following safety cautions before conducting repair work. After the repair work is complete, be sure to conduct a test operation to ensure that the equipment operates normally, and explain the cautions for operating the product to the customer.

	This manual is for the person in charge of maintenance and inspection.
---	--







Caution Items







The caution items are classified into **Warning** and **Caution**. The **Warning** items are especially important since death or serious injury can result if they are not followed closely. The **Caution** items can also lead to serious accidents under some conditions if they are not followed. Therefore, be sure to observe all the safety caution items described below.







Pictograms



- △ This symbol indicates an item for which caution must be exercised. The pictogram shows the item to which attention must be paid.
- This symbol indicates a prohibited action. The prohibited item or action is shown in the illustration or near the symbol.
- This symbol indicates an action that must be taken, or an instruction. The instruction is shown in the illustration or near the symbol.

1.1 Warnings and Cautions Regarding Safety of Workers









 Warning	
<p>Do not store equipment in a room with fire sources (e.g., naked flames, gas appliances, electric heaters).</p>	
<p>Be sure to disconnect the power cable from the socket before disassembling equipment for repair. Working on equipment that is connected to the power supply may cause an electrical shock. If it is necessary to supply power to the equipment to conduct the repair or inspect the circuits, do not touch any electrically charged sections of the equipment.</p>	
<p>If refrigerant gas is discharged during repair work, do not touch the discharged refrigerant gas. Refrigerant gas may cause frostbite.</p>	
<p>When disconnecting the suction or discharge pipe of the compressor at the welded section, evacuate the refrigerant gas completely at a well-ventilated place first. If there is gas remaining inside the compressor, the refrigerant gas or refrigerating machine oil discharges when the pipe is disconnected, and it may cause injury.</p>	
<p>If refrigerant gas leaks during repair work, ventilate the area. Refrigerant gas may generate toxic gases when it contacts flames.</p>	







 Warning	
<p>Be sure to discharge the capacitor completely before conducting repair work. The step-up capacitor supplies high-voltage electricity to the electrical components of the outdoor unit. A charged capacitor may cause an electrical shock.</p>	
<p>Do not turn the air conditioner on or off by plugging in or unplugging the power cable. Plugging in or unplugging the power cable to operate the equipment may cause an electrical shock or fire.</p>	
<p>Be sure to wear a safety helmet, gloves, and a safety belt when working in a high place (more than 2 m (6.5 ft)). Insufficient safety measures may cause a fall.</p>	
<p>In case of R-410A refrigerant models, be sure to use pipes, flare nuts and tools intended for the exclusive use with the R-410A refrigerant. The use of materials for other refrigerant models may cause a serious accident, such as damage to the refrigerant cycle or equipment failure.</p>	
<p>Do not mix air or gas other than the specified refrigerant (R-410A) in the refrigerant system. If air enters the refrigerant system, an excessively high pressure results, causing equipment damage and injury.</p>	







 Caution	
<p>Do not repair electrical components with wet hands. Working on the equipment with wet hands may cause an electrical shock.</p>	
<p>Do not clean the air conditioner with water. Washing the unit with water may cause an electrical shock.</p>	
<p>Be sure to provide an earth / grounding when repairing the equipment in a humid or wet place, to avoid electrical shocks.</p>	
<p>Be sure to turn off the power switch and unplug the power cable when cleaning the equipment. The internal fan rotates at a high speed, and may cause injury.</p>	
<p>Be sure to conduct repair work with appropriate tools. The use of inappropriate tools may cause injury.</p>	





 Caution	
Be sure to check that the refrigerating cycle section has cooled down enough before conducting repair work. Working on the unit when the refrigerating cycle section is hot may cause burns.	
Conduct welding work in a well-ventilated place. Using the welder in an enclosed room may cause oxygen deficiency.	

1.2 Warnings and Cautions Regarding Safety of Users

 Warning	
Do not store the equipment in a room with fire sources (e.g., naked flames, gas appliances, electric heaters).	
Be sure to use parts listed in the service parts list of the applicable model and appropriate tools to conduct repair work. Never attempt to modify the equipment. The use of inappropriate parts or tools may cause an electrical shock, excessive heat generation or fire.	
If the power cable and lead wires are scratched or have deteriorated, be sure to replace them. Damaged cable and wires may cause an electrical shock, excessive heat generation or fire.	
Do not use a joined power cable or extension cable, or share the same power outlet with other electrical appliances, since it may cause an electrical shock, excessive heat generation or fire.	
Be sure to use an exclusive power circuit for the equipment, and follow the local technical standards related to the electrical equipment, the internal wiring regulations, and the instruction manual for installation when conducting electrical work. Insufficient power circuit capacity and improper electrical work may cause an electrical shock or fire.	
Be sure to use the specified cable for wiring between the indoor and outdoor units. Make the connections securely and route the cable properly so that there is no force pulling the cable at the connection terminals. Improper connections may cause excessive heat generation or fire.	
When wiring between the indoor and outdoor units, make sure that the terminal cover does not lift off or dismount because of the cable. If the cover is not mounted properly, the terminal connection section may cause an electrical shock, excessive heat generation or fire.	
Do not damage or modify the power cable. Damaged or modified power cables may cause an electrical shock or fire. Placing heavy items on the power cable, or heating or pulling the power cable may damage it.	





 Warning	
<p>Do not mix air or gas other than the specified refrigerant (R-410A) in the refrigerant system. If air enters the refrigerant system, an excessively high pressure results, causing equipment damage and injury.</p>	
<p>If the refrigerant gas leaks, be sure to locate the leaking point and repair it before charging the refrigerant. After charging the refrigerant, make sure that there is no leak. If the leaking point cannot be located and the repair work must be stopped, be sure to pump-down, and close the service valve, to prevent refrigerant gas from leaking into the room. Refrigerant gas itself is harmless, but it may generate toxic gases when it contacts flames, such as those from fan type and other heaters, stoves and ranges.</p>	
<p>When relocating the equipment, make sure that the new installation site has sufficient strength to withstand the weight of the equipment. If the installation site does not have sufficient strength or the installation work is not conducted securely, the equipment may fall and cause injury.</p>	
<p>Check to make sure that the power cable plug is not dirty or loose, then insert the plug into a power outlet securely. If the plug is dusty or has a loose connection, it may cause an electrical shock or fire.</p>	
<p>When replacing the coin battery in the remote controller, be sure to dispose of the old battery to prevent children from swallowing it. If a child swallows the coin battery, see a doctor immediately.</p>	

 Caution	
<p>Installation of a leakage breaker is necessary in some cases depending on the conditions of the installation site, to prevent electrical shocks.</p>	
<p>Do not install the equipment in a place where there is a possibility of combustible gas leaks. If combustible gas leaks and remains around the unit, it may cause a fire.</p>	
<p>Check to see if parts and wires are mounted and connected properly, and if connections at the soldered or crimped terminals are secure. Improper installation and connections may cause excessive heat generation, fire or an electrical shock.</p>	
<p>If the installation platform or frame has corroded, replace it. A corroded installation platform or frame may cause the unit to fall, resulting in injury.</p>	
<p>Check the earth / grounding, and repair it if the equipment is not properly earthed / grounded. Improper earth / grounding may cause an electrical shock.</p>	

 Caution	
<p>Be sure to measure insulation resistance after the repair, and make sure that the resistance is 1 MΩ or greater. Faulty insulation may cause an electrical shock.</p>	
<p>Be sure to check the drainage of the indoor unit after the repair. Faulty drainage may cause water to enter the room and wet the furniture and floor.</p>	
<p>Do not tilt the unit when removing it. The water inside the unit may spill and wet the furniture and floor.</p>	

2. Icons Used

The following icons are used to attract the attention of the reader to specific information.

Icon	Type of Information	Description
 Warning	Warning	Warning is used when there is danger of personal injury.
 Caution	Caution	Caution is used when there is danger that the reader, through incorrect manipulation, may damage equipment, lose data, get an unexpected result or have to restart (part of) a procedure.
 Note	Note	Note provides information that is not indispensable, but may nevertheless be valuable to the reader, such as tips and tricks.
 Reference	Reference	Reference guides the reader to other places in this binder or in this manual, where he/she will find additional information on a specific topic.

3. Revision History

Month / Year	Version	Revised contents
04 / 2019	SiUS281811E	First edition
03 / 2020	SiUS281811EA	Model addition: RZR18-48TAVJUA, RZQ18-48TAVJUA
12 / 2022	SiUS281811EB	Model addition: RZR18-48TBVJUA, RZQ18-48TBVJUA, FCQ18-48AAVJU, FBQ18-48TBVJU, BRC1H71W

Part 1

General Information

1. Model Names and Power Supply	10
1.1 Cooling Only	10
1.2 Heat Pump	12
2. External Appearance.....	14
2.1 Indoor Unit.....	14
2.2 Outdoor Unit.....	16
2.3 Remote Controller	17
3. Specifications	18
3.1 Cooling Only.....	18
3.2 Heat Pump	54

1. Model Names and Power Supply

1.1 Cooling Only

Indoor unit		Outdoor unit	Power supply
Ceiling mounted cassette type (Round flow with sensing panel)	FCQ18TAVJU	RZR18TAVJU	Indoor unit: 1 phase, 208/230 V, 60 Hz Outdoor unit: 1 phase, 208/230 V, 60 Hz
	FCQ24TAVJU	RZR24TAVJU	
	FCQ30TAVJU	RZR30TAVJU	
	FCQ36TAVJU	RZR36TAVJU	
	FCQ42TAVJU	RZR42TAVJU	
	FCQ48TAVJU	RZR48TAVJU	
	FCQ18TAVJUA	RZR18TAVJUA	
	FCQ24TAVJUA	RZR24TAVJUA	
	FCQ30TAVJUA	RZR30TAVJUA	
	FCQ36TAVJUA	RZR36TAVJUA	
	FCQ42TAVJUA	RZR42TAVJUA	
	FCQ48TAVJUA	RZR48TAVJUA	
	FCQ18AAVJU	RZR18TBVJUA	
	FCQ24AAVJU	RZR24TBVJUA	
	FCQ30AAVJU	RZR30TBVJUA	
	FCQ36AAVJU	RZR36TBVJUA	
FCQ42AAVJU	RZR42TBVJUA		
FCQ48AAVJU	RZR48TBVJUA		
Ceiling suspended type	FHQ18PVJU	RZR18TAVJU	
	FHQ24PVJU	RZR24TAVJU	
	FHQ30PVJU	RZR30TAVJU	
	FHQ36MVJU	RZR36TAVJU	
	FHQ42MVJU	RZR42TAVJU	
	FHQ18PVJUA	RZR18TAVJUA	
	FHQ24PVJUA	RZR24TAVJUA	
	FHQ30PVJUA	RZR30TAVJUA	
	FHQ36MVJUA	RZR36TAVJUA	
	FHQ42MVJUA	RZR42TAVJUA	
Wall mounted type	FAQ18TAVJU	RZR18TAVJU	
	FAQ24TAVJU	RZR24TAVJU	
	FAQ18TAVJUA	RZR18TAVJUA	
	FAQ24TAVJUA	RZR24TAVJUA	
	FAQ18TAVJUA	RZR18TBVJUA	
	FAQ24TAVJUA	RZR24TBVJUA	
HSP ceiling mounted duct type	FBQ18PVJU	RZR18TAVJU	
	FBQ24PVJU	RZR24TAVJU	
	FBQ30PVJU	RZR30TAVJU	
	FBQ36PVJU	RZR36TAVJU	
	FBQ42PVJU	RZR42TAVJU	
	FBQ48PVJU	RZR48TAVJU	
	FBQ18PVJUA	RZR18TAVJUA	
	FBQ24PVJUA	RZR24TAVJUA	
	FBQ30PVJUA	RZR30TAVJUA	
	FBQ36PVJUA	RZR36TAVJUA	
	FBQ42PVJUA	RZR42TAVJUA	
	FBQ48PVJUA	RZR48TAVJUA	

Indoor unit		Outdoor unit	Power supply
HSP ceiling mounted duct type	FBQ18TBVJU	RZR18TBVJUA	Indoor unit: 1 phase, 208/230 V, 60 Hz Outdoor unit: 1 phase, 208/230 V, 60 Hz
	FBQ24TBVJU	RZR24TBVJUA	
	FBQ30TBVJU	RZR30TBVJUA	
	FBQ36TBVJU	RZR36TBVJUA	
	FBQ42TBVJU	RZR42TBVJUA	
	FBQ48TBVJU	RZR48TBVJUA	
Multi position air handling unit	FTQ18TAVJUD	RZR18TAVJU	
	FTQ24TAVJUD	RZR24TAVJU	
	FTQ30TAVJUD	RZR30TAVJU	
	FTQ36TAVJUD	RZR36TAVJU	
	FTQ42TAVJUD	RZR42TAVJU	
	FTQ48TAVJUD	RZR48TAVJU	
	FTQ18TAVJUA	RZR18TAVJUA	
	FTQ24TAVJUA	RZR24TAVJUA	
	FTQ30TAVJUA	RZR30TAVJUA	
	FTQ36TAVJUA	RZR36TAVJUA	
	FTQ42TAVJUA	RZR42TAVJUA	
	FTQ48TAVJUA	RZR48TAVJUA	
	FTQ18TAVJUD	RZR18TBVJUA	
	FTQ24TAVJUD	RZR24TBVJUA	
	FTQ30TAVJUD	RZR30TBVJUA	
	FTQ36TAVJUD	RZR36TBVJUA	
	FTQ42TAVJUD	RZR42TBVJUA	
	FTQ48TAVJUD	RZR48TBVJUA	
	FTQ18TAVJUA	RZR18TAVJU	
	FTQ24TAVJUA	RZR24TAVJU	
	FTQ30TAVJUA	RZR30TAVJU	
	FTQ36TAVJUA	RZR36TAVJU	
	FTQ42TAVJUA	RZR42TAVJU	
	FTQ48TAVJUA	RZR48TAVJU	
	FTQ18TAVJUA	RZR18TAVJUA	
	FTQ24TAVJUA	RZR24TAVJUA	
	FTQ30TAVJUA	RZR30TAVJUA	
	FTQ36TAVJUA	RZR36TAVJUA	
	FTQ42TAVJUA	RZR42TAVJUA	
	FTQ48TAVJUA	RZR48TAVJUA	
FTQ18TAVJUA	RZR18TBVJUA		
FTQ24TAVJUA	RZR24TBVJUA		
FTQ30TAVJUA	RZR30TBVJUA		
FTQ36TAVJUA	RZR36TBVJUA		
FTQ42TAVJUA	RZR42TBVJUA		
FTQ48TAVJUA	RZR48TBVJUA		

**Note(s)**

1. Power supply intake: outdoor unit
 2. VJ: 1 phase, 208/230 V, 60 Hz
- U (VJU): Standard symbol
A: Minor revision

1.2 Heat Pump

Indoor unit	Outdoor unit	Power supply	
Ceiling mounted cassette type (Round flow with sensing panel)	FCQ18TAVJU	RZQ18TAVJU	Indoor unit: 1 phase, 208/230 V, 60 Hz Outdoor unit: 1 phase, 208/230 V, 60 Hz
	FCQ24TAVJU	RZQ24TAVJU	
	FCQ30TAVJU	RZQ30TAVJU	
	FCQ36TAVJU	RZQ36TAVJU	
	FCQ42TAVJU	RZQ42TAVJU	
	FCQ48TAVJU	RZQ48TAVJU	
	FCQ18TAVJU	RZQ18TAVJUA	
	FCQ24TAVJU	RZQ24TAVJUA	
	FCQ30TAVJU	RZQ30TAVJUA	
	FCQ36TAVJU	RZQ36TAVJUA	
	FCQ42TAVJU	RZQ42TAVJUA	
	FCQ48TAVJU	RZQ48TAVJUA	
	FCQ18AAVJU	RZQ18TBVJUA	
	FCQ24AAVJU	RZQ24TBVJUA	
	FCQ30AAVJU	RZQ30TBVJUA	
	FCQ36AAVJU	RZQ36TBVJUA	
	FCQ42AAVJU	RZQ42TBVJUA	
FCQ48AAVJU	RZQ48TBVJUA		
Ceiling suspended type	FHQ18PVJU	RZQ18TAVJU	
	FHQ24PVJU	RZQ24TAVJU	
	FHQ30PVJU	RZQ30TAVJU	
	FHQ36MVJU	RZQ36TAVJU	
	FHQ42MVJU	RZQ42TAVJU	
	FHQ18PVJU	RZQ18TAVJUA	
	FHQ24PVJU	RZQ24TAVJUA	
	FHQ30PVJU	RZQ30TAVJUA	
	FHQ36MVJU	RZQ36TAVJUA	
	FHQ42MVJU	RZQ42TAVJUA	
Wall mounted type	FAQ18TAVJU	RZQ18TAVJU	
	FAQ24TAVJU	RZQ24TAVJU	
	FAQ18TAVJU	RZQ18TAVJUA	
	FAQ24TAVJU	RZQ24TAVJUA	
	FAQ18TAVJU	RZQ18TBVJUA	
	FAQ24TAVJU	RZQ24TBVJUA	
HSP ceiling mounted duct type	FBQ18PVJU	RZQ18TAVJU	
	FBQ24PVJU	RZQ24TAVJU	
	FBQ30PVJU	RZQ30TAVJU	
	FBQ36PVJU	RZQ36TAVJU	
	FBQ42PVJU	RZQ42TAVJU	
	FBQ48PVJU	RZQ48TAVJU	
	FBQ18PVJU	RZQ18TAVJUA	
	FBQ24PVJU	RZQ24TAVJUA	
	FBQ30PVJU	RZQ30TAVJUA	
	FBQ36PVJU	RZQ36TAVJUA	
	FBQ42PVJU	RZQ42TAVJUA	
	FBQ48PVJU	RZQ48TAVJUA	

Indoor unit		Outdoor unit	Power supply
HSP ceiling mounted duct type	FBQ18TBVJU	RZQ18TBVJUA	Indoor unit: 1 phase, 208/230 V, 60 Hz Outdoor unit: 1 phase, 208/230 V, 60 Hz
	FBQ24TBVJU	RZQ24TBVJUA	
	FBQ30TBVJU	RZQ30TBVJUA	
	FBQ36TBVJU	RZQ36TBVJUA	
	FBQ42TBVJU	RZQ42TBVJUA	
	FBQ48TBVJU	RZQ48TBVJUA	
Multi position air handling unit	FTQ18TAVJUD	RZQ18TAVJU	
	FTQ24TAVJUD	RZQ24TAVJU	
	FTQ30TAVJUD	RZQ30TAVJU	
	FTQ36TAVJUD	RZQ36TAVJU	
	FTQ42TAVJUD	RZQ42TAVJU	
	FTQ48TAVJUD	RZQ48TAVJU	
	FTQ18TAVJUA	RZQ18TAVJUA	
	FTQ24TAVJUA	RZQ24TAVJUA	
	FTQ30TAVJUA	RZQ30TAVJUA	
	FTQ36TAVJUA	RZQ36TAVJUA	
	FTQ42TAVJUA	RZQ42TAVJUA	
	FTQ48TAVJUA	RZQ48TAVJUA	
	FTQ18TAVJUD	RZQ18TBVJUA	
	FTQ24TAVJUD	RZQ24TBVJUA	
	FTQ30TAVJUD	RZQ30TBVJUA	
	FTQ36TAVJUD	RZQ36TBVJUA	
	FTQ42TAVJUD	RZQ42TBVJUA	
	FTQ48TAVJUD	RZQ48TBVJUA	
	FTQ18TAVJUA	RZQ18TAVJU	
	FTQ24TAVJUA	RZQ24TAVJU	
	FTQ30TAVJUA	RZQ30TAVJU	
	FTQ36TAVJUA	RZQ36TAVJU	
	FTQ42TAVJUA	RZQ42TAVJU	
	FTQ48TAVJUA	RZQ48TAVJU	
	FTQ18TAVJUA	RZQ18TAVJUA	
	FTQ24TAVJUA	RZQ24TAVJUA	
	FTQ30TAVJUA	RZQ30TAVJUA	
	FTQ36TAVJUA	RZQ36TAVJUA	
	FTQ42TAVJUA	RZQ42TAVJUA	
	FTQ48TAVJUA	RZQ48TAVJUA	
FTQ18TAVJUA	RZQ18TBVJUA		
FTQ24TAVJUA	RZQ24TBVJUA		
FTQ30TAVJUA	RZQ30TBVJUA		
FTQ36TAVJUA	RZQ36TBVJUA		
FTQ42TAVJUA	RZQ42TBVJUA		
FTQ48TAVJUA	RZQ48TBVJUA		

**Note(s)**

1. Power supply intake: outdoor unit
 2. VJ: 1 phase, 208/230 V, 60 Hz
- U (VJU): Standard symbol
A: Minor revision

2. External Appearance

2.1 Indoor Unit

Ceiling Mounted Cassette Type (Round Flow with Sensing Panel)

FCQ18TAVJU
FCQ24TAVJU
FCQ30TAVJU
FCQ36TAVJU
FCQ42TAVJU
FCQ48TAVJU



Shown with BYCQ125B-W1

FCQ18AAVJU
FCQ24AAVJU
FCQ30AAVJU
FCQ36AAVJU
FCQ42AAVJU
FCQ48AAVJU



Shown with BYCQ54EEFU

Ceiling Suspended Type

FHQ18PVJU
FHQ24PVJU
FHQ30PVJU
FHQ36MVJU
FHQ42MVJU



Wall Mounted Type

FAQ18TAVJU
FAQ24TAVJU



HSP Ceiling Mounted Duct Type

FBQ18PVJU
FBQ24PVJU
FBQ30PVJU
FBQ36PVJU
FBQ42PVJU
FBQ48PVJU



FBQ18TBVJU
FBQ24TBVJU
FBQ30TBVJU
FBQ36TBVJU
FBQ42TBVJU
FBQ48TBVJU

**Multi Position Air Handling Unit**

FTQ18TAVJUD FTQ18TAVJUA
FTQ24TAVJUD FTQ24TAVJUA
FTQ30TAVJUD FTQ30TAVJUA
FTQ36TAVJUD FTQ36TAVJUA
FTQ42TAVJUD FTQ42TAVJUA
FTQ48TAVJUD FTQ48TAVJUA



2.2 Outdoor Unit

RZR18TAVJU RZR18TAVJUA
RZR24TAVJU RZR24TAVJUA

RZQ18TAVJU RZQ18TAVJUA
RZQ24TAVJU RZQ24TAVJUA



RZR18TBVJUA
RZR24TBVJUA

RZQ18TBVJUA
RZQ24TBVJUA



RZR30TAVJU RZR30TAVJUA
RZR36TAVJU RZR36TAVJUA
RZR42TAVJU RZR42TAVJUA
RZR48TAVJU RZR48TAVJUA

RZQ30TAVJU RZQ30TAVJUA
RZQ36TAVJU RZQ36TAVJUA
RZQ42TAVJU RZQ42TAVJUA
RZQ48TAVJU RZQ48TAVJUA



RZR30TBVJUA
RZR36TBVJUA
RZR42TBVJUA
RZR48TBVJUA

RZQ30TBVJUA
RZQ36TBVJUA
RZQ42TBVJUA
RZQ48TBVJUA



2.3 Remote Controller

Wired remote controller

Navigation: BRC1E73

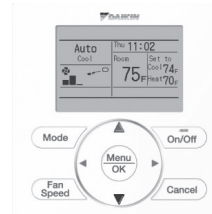

Madoka: BRC1H71W



Wireless remote controller

BRC7E83 (FHQ)

BRC7E818 (FAQ)

BRC4C82 (FBQ-P (*1), FTQ)

BRC082A43 (FBQ-P (*1), FBQ-TB)



- *1. For FBQ-P series, the fan step control is different according to the wireless remote controller used.
 BRC4C82 (Fan: 2 steps)
 BRC082A43 (Fan: 3 steps)

3. Specifications

3.1 Cooling Only

3.1.1 Ceiling Mounted Cassette Type (Round Flow with Sensing Panel)

Model name	Indoor unit		FCQ18TAVJU	FCQ24TAVJU
	Outdoor unit		RZR18TAVJU	RZR24TAVJU
Power supply			1 phase, 208/230 V, 60 Hz	1 phase, 208/230 V, 60 Hz
★1 ★2 Cooling capacity	Btu/h (kW)		18,000 (5.3)	24,000 (7.0)
SEER (Rated)			18.6	18.5
EER (Rated)	Btu/h·W		13.0	12.0
Indoor unit			FCQ18TAVJU	FCQ24TAVJU
Casing color			Galvanized steel plate	Galvanized steel plate
Dimensions: (H×W×D)	in (mm)		10-1/16 × 33-1/16 × 33-1/16 (256 × 840 × 840)	10-1/16 × 33-1/16 × 33-1/16 (256 × 840 × 840)
Coil	Type		Cross fin coil	Cross fin coil
	Rows×Stages×FPI		3 × (12 + 15 × 2) × (20 + 21 × 2)	3 × (12 + 15 × 2) × (20 + 21 × 2)
	Face area	ft ² (m ²)	4.59 (0.427)	4.59 (0.427)
Fan	Model		QTS48C15M	QTS48C15M
	Type		Turbo fan	Turbo fan
	Motor output	W	48	48
	Airflow rate (H/M/L)	cfm (m ³ /min)	742/618/477 (21.0/17.5/13.5)	777/618/477 (22.0/17.5/13.5)
Sound pressure level (H/M/L)	dB(A)		35.5/32.0/28.0	36.0/32.0/28.0
Air filter			—	—
Weight	lbs (kg)		63 (28.5)	63 (28.5)
Connecting Pipes	Liquid Pipe	in (mm)	φ3/8 (φ9.5) (Flare connection)	φ3/8 (φ9.5) (Flare connection)
	Gas Pipe	in (mm)	φ5/8 (φ15.9) (Flare connection)	φ5/8 (φ15.9) (Flare connection)
	Drain Pipe	in (mm)	VP25 (External dia. 1-1/4 (32), internal dia. 1 (26))	VP25 (External dia. 1-1/4 (32), internal dia. 1 (26))
Remote controller (option)	Wired		BRC1E73, BRC2A71	BRC1E73, BRC2A71
	Wireless		—	—
Decoration panels (option)	Model		BYCQ125B-W1 / BYCQ125BGW1	BYCQ125B-W1 / BYCQ125BGW1
	Color		Fresh white	Fresh white
	Dimensions: (H×W×D)	in (mm)	2 × 37-3/8 × 37-3/8 / 5-1/8 × 37-3/8 × 37-3/8 (50 × 950 × 950 / 130 × 950 × 950)	2 × 37-3/8 × 37-3/8 / 5-1/8 × 37-3/8 × 37-3/8 (50 × 950 × 950 / 130 × 950 × 950)
	Air filter		Resin net (with mold resistance)	Resin net (With mold resistance)
	Weight	lbs (kg)	12.2 (5.5) / 22.1 (10.0)	12.2 (5.5) / 22.1 (10.0)
Outdoor unit			RZR18TAVJU	RZR24TAVJU
Casing color			Ivory white	Ivory white
Dimensions: (H×W×D)	in (mm)		39 × 37 × 12-5/8 (990 × 940 × 320)	39 × 37 × 12-5/8 (990 × 940 × 320)
Coil	Type		Cross fin coil	Cross fin coil
	Rows×Stages×FPI		2 × 44 × 19	2 × 44 × 19
	Face area	ft ² (m ²)	9.5 (0.88)	9.5 (0.88)
Compressor	Model		2YC63ABXDD	2YC63ABXDD
	Type		Hermetically sealed swing type	Hermetically sealed swing type
	Motor output	kW	1.9	1.9
Fan	Model		P51J11F	P51J11F
	Type		Propeller fan	Propeller fan
	Motor output	W	200	200
	Airflow rate	cfm (m ³ /min)	2,682 (76)	2,682 (76)
Weight	lbs (kg)		172 (78)	172 (78)
Sound pressure level	dB(A)		58	58
Connecting Pipes	Liquid Pipe	in (mm)	φ3/8 (φ9.5) (Flare connection)	φ3/8 (φ9.5) (Flare connection)
	Gas Pipe	in (mm)	φ5/8 (φ15.9) (Flare connection)	φ5/8 (φ15.9) (Flare connection)
	Drain Pipe	in (mm)	φ1 (φ26) (Hole)	φ1 (φ26) (Hole)
Safety devices			High pressure switch, Outdoor fan driver overload protector, Inverter overload protector, Fusible plugs, Fuse	High pressure switch, Outdoor fan driver overload protector, Inverter overload protector, Fusible plugs, Fuse
Capacity Control	%		14-100	14-100
Refrigerant control			Electronic expansion valve	Electronic expansion valve
Ref. piping	Standard length	ft (m)	25 (7.6)	25 (7.6)
	Max. length	ft (m)	164 (50)	164 (50)
	Max. height difference	ft (m)	98 (30)	98 (30)
Refrigerant	Model		R-410A	R-410A
	Charge	lbs (kg)	6.4 (2.9)	6.4 (2.9)
Ref. oil	Model		DAPHNE FVC50K	DAPHNE FVC50K
	Charge	L	1.08	1.08
Drawing No.	Specification		C: 4D115509	C: 4D115509
	Sound (indoor)		C: 4D087483B	C: 4D087474B
	Sound (outdoor)		C: 4D101947D	C: 4D101947D
Notes:				
★1 Indoor temp. : 80°FDB (26.7°CDB), 67°FWB (19.4°CWB) / outdoor temp. : 95°FDB (35.0°CDB) / Equivalent piping length : 25 ft (7.6 m), level difference : 0 ft (0 m).				
★2 Capacities are net, including a deduction for cooling for indoor fan motor heat.				

Model name	Indoor unit		FCQ30TAVJU	FCQ36TAVJU
	Outdoor unit		RZR30TAVJU	RZR36TAVJU
Power supply			1 phase, 208/230 V, 60 Hz	1 phase, 208/230 V, 60 Hz
★1 ★2 Cooling capacity	Btu/h (kW)		30,000 (8.8)	36,000 (10.6)
SEER (Rated)			17.2	17.6
EER (Rated)	Btu/h-W		9.3	11.4
Indoor unit		FCQ30TAVJU		FCQ36TAVJU
Casing color			Galvanized steel plate	Galvanized steel plate
Dimensions: (H×W×D)	in (mm)		11-23/32 × 33-1/16 × 33-1/16 (298 × 840 × 840)	11-23/32 × 33-1/16 × 33-1/16 (298 × 840 × 840)
Coil	Type		Cross fin coil	Cross fin coil
	Rows×Stages×FPI		3 × 18 × (20 + 21 × 2)	3 × 18 × (20 + 21 × 2)
	Face area	ft ² (m ²)	5.92 (0.550)	5.92 (0.550)
Fan	Model		QTS48C15M	QTS48C15M
	Type		Turbo fan	Turbo fan
	Motor output	W	106	106
	Airflow rate (H/M/L)	cfm (m ³ /min)	1,112/918/671 (31.5/26.0/19.0)	1,165/918/671 (33.0/26.0/19.0)
Sound pressure level (H/M/L)	dB(A)	43.5/38.0/32.0	44.0/38.0/32.0	
Air filter			—	—
Weight	lbs (kg)		70 (31.5)	70 (31.5)
Connecting Pipes	Liquid Pipe	in (mm)	φ3/8 (φ9.5) (Flare connection)	φ3/8 (φ9.5) (Flare connection)
	Gas Pipe	in (mm)	φ5/8 (φ15.9) (Flare connection)	φ5/8 (φ15.9) (Flare connection)
	Drain Pipe	in (mm)	VP25 (External dia. 1-1/4 (32), internal dia. 1 (26))	VP25 (External dia. 1-1/4 (32), internal dia. 1 (26))
Remote controller (option)	Wired		BRC1E73, BRC2A71	BRC1E73, BRC2A71
	Wireless		—	—
Decoration panels (option)	Model		BYCQ125B-W1 / BYCQ125BGW1	BYCQ125B-W1 / BYCQ125BGW1
	Color		Fresh white	Fresh white
	Dimensions: (H×W×D)	in (mm)	2 × 37-3/8 × 37-3/8 / 5-1/8 × 37-3/8 × 37-3/8 (50 × 950 × 950 / 130 × 950 × 950)	2 × 37-3/8 × 37-3/8 / 5-1/8 × 37-3/8 × 37-3/8 (50 × 950 × 950 / 130 × 950 × 950)
	Air filter		Resin net (with mold resistance)	Resin net (with mold resistance)
	Weight	lbs (kg)	12.2 (5.5) / 22.1 (10.0)	12.2 (5.5) / 22.1 (10.0)
Outdoor unit		RZR30TAVJU		RZR36TAVJU
Casing color			Ivory white	Ivory white
Dimensions: (H×W×D)	in (mm)		52-15/16 × 35-7/16 × 12-5/8 (1,345 × 900 × 320)	52-15/16 × 35-7/16 × 12-5/8 (1,345 × 900 × 320)
Coil	Type		Cross fin coil	Cross fin coil
	Rows×Stages×FPI		2 × 60 × 19	2 × 60 × 19
	Face area	ft ² (m ²)	12.2 (1.134)	12.2 (1.134)
Compressor	Model		2YC90GXD#D	2YC90GXD#D
	Type		Hermetically sealed swing type	Hermetically sealed swing type
	Motor output	kW	3.5	3.5
Fan	Model		P47N	P47N
	Type		Propeller fan	Propeller fan
	Motor output	W	70 × 2	70 × 2
	Airflow rate	cfm (m ³ /min)	3,741 (106)	3,741 (106)
Weight	lbs (kg)		225 (102)	225 (102)
Sound pressure level	dB(A)		57	57
Connecting Pipes	Liquid Pipe	in (mm)	φ3/8 (φ9.5) (Flare connection)	φ3/8 (φ9.5) (Flare connection)
	Gas Pipe	in (mm)	φ5/8 (φ15.9) (Flare connection)	φ5/8 (φ15.9) (Flare connection)
	Drain Pipe	in (mm)	φ1 (φ26) (Hole)	φ1 (φ26) (Hole)
Safety devices			High pressure switch, Outdoor fan driver overload protector, Inverter overload protector, Fusible plugs, Fuse	High pressure switch, Outdoor fan driver overload protector, Inverter overload protector, Fusible plugs, Fuse
Capacity Control	%		14-100	14-100
Refrigerant control			Electronic expansion valve	Electronic expansion valve
Ref. piping	Standard length	ft (m)	25 (7.6)	25 (7.6)
	Max. length	ft (m)	230 (70)	230 (70)
	Max. height difference	ft (m)	98 (30)	98 (30)
Refrigerant	Model		R-410A	R-410A
	Charge	lbs (kg)	7.9 (3.6)	7.9 (3.6)
Ref. oil	Model		DAPHNE FVC50K	DAPHNE FVC50K
	Charge	L	1.52	1.52
Drawing No.	Specification		C: 4D115511	C: 4D115511
	Sound (indoor)		C: 4D087479B	C: 4D087475B
	Sound (outdoor)		C: 4D101949D	C: 4D101949D
Notes:				
★1 Indoor temp. : 80°FDB (26.7°CDB), 67°FWB (19.4°CWB) / outdoor temp. : 95°FDB (35.0°CDB) / Equivalent piping length : 25 ft (7.6 m), level difference : 0 ft (0 m).				
★2 Capacities are net, including a deduction for cooling for indoor fan motor heat.				

Model name	Indoor unit		FCQ42TAVJU	FCQ48TAVJU
	Outdoor unit		RZR42TAVJU	RZR48TAVJU
Power supply			1 phase, 208/230 V, 60 Hz	1 phase, 208/230 V, 60 Hz
★1 ★2 Cooling capacity	Btu/h (kW)		42,000 (12.3)	48,000 (14.1)
SEER (Rated)			17.0	17.0
EER (Rated)	Btu/h-W		10.3	9.0
Indoor unit			FCQ42TAVJU	FCQ48TAVJU
Casing color			Galvanized steel plate	Galvanized steel plate
Dimensions: (H×W×D)			in (mm) 11-23/32 × 33-1/16 × 33-1/16 (298 × 840 × 840)	11-23/32 × 33-1/16 × 33-1/16 (298 × 840 × 840)
Coil	Type		Cross fin coil	Cross fin coil
	Rows×Stages×FPI		3 × 18 × (20 + 21 × 2)	3 × 18 × (20 + 21 × 2)
	Face area	ft ² (m ²)	5.92 (0.550)	5.92 (0.550)
Fan	Model		QTS48C15M	QTS48C15M
	Type		Turbo fan	Turbo fan
	Motor output	W	106	106
	Airflow rate (H/M/L)	cfm (m ³ /min)	1,218/971/742 (34.5/27.5/21.0)	1,218/971/742 (34.5/27.5/21.0)
Sound pressure level (H/M/L)			45.0/40.0/35.0	45.0/40.0/35.0
Air filter			—	—
Weight			lbs (kg) 70 (31.5)	70 (31.5)
Connecting Pipes	Liquid Pipe	in (mm)	φ3/8 (φ9.5) (Flare connection)	φ3/8 (φ9.5) (Flare connection)
	Gas Pipe	in (mm)	φ5/8 (φ15.9) (Flare connection)	φ5/8 (φ15.9) (Flare connection)
	Drain Pipe	in (mm)	VP25 (External dia. 1-1/4 (32), internal dia. 1 (26))	VP25 (External dia. 1-1/4 (32), internal dia. 1 (26))
Remote controller (option)	Wired		BRC1E73, BRC2A71	BRC1E73, BRC2A71
	Wireless		—	—
Decoration panels (option)	Model		BYCQ125B-W1 / BYCQ125BGW1	BYCQ125B-W1 / BYCQ125BGW1
	Color		Fresh white	Fresh white
	Dimensions: (H×W×D)	in (mm)	2 × 37-3/8 × 37-3/8 / 5-1/8 × 37-3/8 × 37-3/8 (50 × 950 × 950 / 130 × 950 × 950)	2 × 37-3/8 × 37-3/8 / 5-1/8 × 37-3/8 × 37-3/8 (50 × 950 × 950 / 130 × 950 × 950)
	Air filter		Resin net (with mold resistance)	Resin net (with mold resistance)
	Weight	lbs (kg)	12.2 (5.5) / 22.1 (10.0)	12.2 (5.5) / 22.1 (10.0)
Outdoor unit			RZR42TAVJU	RZR48TAVJU
Casing color			Ivory white	Ivory white
Dimensions: (H×W×D)			in (mm) 52-15/16 × 35-7/16 × 12-5/8 (1,345 × 900 × 320)	52-15/16 × 35-7/16 × 12-5/8 (1,345 × 900 × 320)
Coil	Type		Cross fin coil	Cross fin coil
	Rows×Stages×FPI		2 × 60 × 19	2 × 60 × 19
	Face area	ft ² (m ²)	12.2 (1.134)	12.2 (1.134)
Compressor	Model		2YC90GXD#D	2YC90GXD#D
	Type		Hermetically sealed swing type	Hermetically sealed swing type
	Motor output	kW	3.5	3.5
Fan	Model		P47N	P47N
	Type		Propeller fan	Propeller fan
	Motor output	W	70 × 2	70 × 2
	Airflow rate	cfm (m ³ /min)	3,741 (106)	3,741 (106)
Weight			lbs (kg) 225 (102)	225 (102)
Sound pressure level			dB(A) 57	57
Connecting Pipes	Liquid Pipe	in (mm)	φ3/8 (φ9.5) (Flare connection)	φ3/8 (φ9.5) (Flare connection)
	Gas Pipe	in (mm)	φ5/8 (φ15.9) (Flare connection)	φ5/8 (φ15.9) (Flare connection)
	Drain Pipe	in (mm)	φ1 (φ26) (Hole)	φ1 (φ26) (Hole)
Safety devices			High pressure switch, Outdoor fan driver overload protector, Inverter overload protector, Fusible plugs, Fuse	High pressure switch, Outdoor fan driver overload protector, Inverter overload protector, Fusible plugs, Fuse
Capacity Control			% 14-100	14-100
Refrigerant control			Electronic expansion valve	Electronic expansion valve
Ref. piping	Standard length	ft (m)	25 (7.6)	25 (7.6)
	Max. length	ft (m)	230 (70)	230 (70)
	Max. height difference	ft (m)	98 (30)	98 (30)
Refrigerant	Model		R-410A	R-410A
	Charge	lbs (kg)	7.9 (3.6)	7.9 (3.6)
Ref. oil	Model		DAPHNE FVC50K	DAPHNE FVC50K
	Charge	L	1.52	1.52
Drawing No.	Specification		C: 4D115511	C: 4D115511
	Sound (indoor)		C: 4D087476B	C: 4D087476B
	Sound (outdoor)		C: 4D101949D	C: 4D101949D

Notes:

★1 Indoor temp. : 80°FDB (26.7°CDB), 67°FWB (19.4°CWB) / outdoor temp. : 95°FDB (35.0°CDB) / Equivalent piping length : 25 ft (7.6 m), level difference : 0 ft (0 m).
 ★2 Capacities are net, including a deduction for cooling for indoor fan motor heat.

Model name		Indoor unit	FCQ18TAVJU	FCQ24TAVJU
		Outdoor unit	RZR18TAVJUA	RZR24TAVJUA
Power supply			1 phase, 208/230 V, 60 Hz	1 phase, 208/230 V, 60 Hz
★1 ★2 Cooling capacity	Btu/h (kW)		18,000 (5.3)	24,000 (7.0)
SEER (Rated)			18.6	18.5
EER (Rated)	Btu/h-W		13.0	12.0
Indoor unit		FCQ18TAVJU	FCQ24TAVJU	
Casing color			Galvanized steel plate	Galvanized steel plate
Dimensions: (H×W×D)		in (mm)	10-1/16 × 33-1/16 × 33-1/16 (256 × 840 × 840)	10-1/16 × 33-1/16 × 33-1/16 (256 × 840 × 840)
Coil	Type		Cross fin coil	Cross fin coil
	Rows×Stages×FPI		3 × (12 + 15 × 2) × (20 + 21 × 2)	3 × (12 + 15 × 2) × (20 + 21 × 2)
	Face area	ft ² (m ²)	4.59 (0.427)	4.59 (0.427)
Fan	Model		QTS48C15M	QTS48C15M
	Type		Turbo fan	Turbo fan
	Motor output	W	48	48
	Airflow rate (H/M/L)	cfm (m ³ /min)	742/618/477 (21.0/17.5/13.5)	777/618/477 (22.0/17.5/13.5)
Sound pressure level (H/M/L)	dB(A)		35.5/32.0/28.0	36.0/32.0/28.0
Air filter			—	—
Weight		lbs (kg)	63 (28.5)	63 (28.5)
Connecting Pipes	Liquid Pipe	in (mm)	φ3/8 (φ9.5) (Flare connection)	φ3/8 (φ9.5) (Flare connection)
	Gas Pipe	in (mm)	φ5/8 (φ15.9) (Flare connection)	φ5/8 (φ15.9) (Flare connection)
	Drain Pipe	in (mm)	VP25 (External dia. 1-1/4 (32), internal dia. 1 (26))	VP25 (External dia. 1-1/4 (32), internal dia. 1 (26))
Remote controller (option)	Wired		BRC1E73, BRC2A71	BRC1E73, BRC2A71
	Wireless		—	—
Decoration panels (option)	Model		BYCQ125B-W1 / BYCQ125BGW1	BYCQ125B-W1 / BYCQ125BGW1
	Color		Fresh white	Fresh white
	Dimensions: (H×W×D)	in (mm)	2 × 37-3/8 × 37-3/8 / 5-1/8 × 37-3/8 × 37-3/8 (50 × 950 × 950 / 130 × 950 × 950)	2 × 37-3/8 × 37-3/8 / 5-1/8 × 37-3/8 × 37-3/8 (50 × 950 × 950 / 130 × 950 × 950)
	Air filter		Resin net (with mold resistance)	Resin net (With mold resistance)
	Weight	lbs (kg)	12.2 (5.5) / 22.1 (10.0)	12.2 (5.5) / 22.1 (10.0)
Outdoor unit		RZR18TAVJUA	RZR24TAVJUA	
Casing color			Ivory white	Ivory white
Dimensions: (H×W×D)		in (mm)	39 × 37 × 12-5/8 (990 × 940 × 320)	39 × 37 × 12-5/8 (990 × 940 × 320)
Coil	Type		Cross fin coil	Cross fin coil
	Rows×Stages×FPI		2 × 44 × 19	2 × 44 × 19
	Face area	ft ² (m ²)	9.5 (0.88)	9.5 (0.88)
Compressor	Model		2YC63TXD#A	2YC63TXD#A
	Type		Hermetically sealed swing type	Hermetically sealed swing type
	Motor output	kW	1.9	1.9
Fan	Model		P51J11F	P51J11F
	Type		Propeller fan	Propeller fan
	Motor output	W	200	200
	Airflow rate	cfm (m ³ /min)	2,682 (76)	2,682 (76)
Weight		lbs (kg)	172 (78)	172 (78)
Sound pressure level		dB(A)	58	58
Connecting Pipes	Liquid Pipe	in (mm)	φ3/8 (φ9.5) (Flare connection)	φ3/8 (φ9.5) (Flare connection)
	Gas Pipe	in (mm)	φ5/8 (φ15.9) (Flare connection)	φ5/8 (φ15.9) (Flare connection)
	Drain Pipe	in (mm)	φ1 (φ26) (Hole)	φ1 (φ26) (Hole)
Safety devices			High pressure switch, Outdoor fan driver overload protector, Inverter overload protector, Fusible plugs, Fuse	High pressure switch, Outdoor fan driver overload protector, Inverter overload protector, Fusible plugs, Fuse
Capacity Control		%	14-100	14-100
Refrigerant control			Electronic expansion valve	Electronic expansion valve
Ref. piping	Standard length	ft (m)	25 (7.6)	25 (7.6)
	Max. length	ft (m)	164 (50)	164 (50)
	Max. height difference	ft (m)	98 (30)	98 (30)
Refrigerant	Model		R-410A	R-410A
	Charge	lbs (kg)	6.4 (2.9)	6.4 (2.9)
Ref. oil	Model		DAPHNE FVC50K	DAPHNE FVC50K
	Charge	L	1.08	1.08
Drawing No.	Specification		C: 4D126347	C: 4D126347
	Sound (indoor)		C: 4D087483B	C: 4D087474B
	Sound (outdoor)		C: 4D101947D	C: 4D101947D
Notes:				
★1 Indoor temp. : 80°FDB (26.7°CDB), 67°FWB (19.4°CWB) / outdoor temp. : 95°FDB (35.0°CDB) / Equivalent piping length : 25 ft (7.6 m), level difference : 0 ft (0 m).				
★2 Capacities are net, including a deduction for cooling for indoor fan motor heat.				

Model name		Indoor unit	FCQ30TAVJU	FCQ36TAVJU
		Outdoor unit	RZR30TAVJUA	RZR36TAVJUA
Power supply			1 phase, 208/230 V, 60 Hz	1 phase, 208/230 V, 60 Hz
★1 ★2 Cooling capacity	Btu/h (kW)		30,000 (8.8)	36,000 (10.6)
SEER (Rated)			17.2	17.6
EER (Rated)	Btu/h-W		9.3	11.4
Indoor unit			FCQ30TAVJU	FCQ36TAVJU
Casing color			Galvanized steel plate	Galvanized steel plate
Dimensions: (H×W×D)		in (mm)	11-23/32 × 33-1/16 × 33-1/16 (298 × 840 × 840)	11-23/32 × 33-1/16 × 33-1/16 (298 × 840 × 840)
Coil	Type		Cross fin coil	Cross fin coil
	Rows×Stages×FPI		3 × 18 × (20 + 21 × 2)	3 × 18 × (20 + 21 × 2)
	Face area	ft ² (m ²)	5.92 (0.550)	5.92 (0.550)
Fan	Model		QTS48C15M	QTS48C15M
	Type		Turbo fan	Turbo fan
	Motor output	W	106	106
	Airflow rate (H/M/L)	cfm (m ³ /min)	1,112/918/671 (31.5/26.0/19.0)	1,165/918/671 (33.0/26.0/19.0)
Sound pressure level (H/M/L)	dB(A)		43.5/38.0/32.0	44.0/38.0/32.0
Air filter			—	—
Weight		lbs (kg)	70 (31.5)	70 (31.5)
Connecting Pipes	Liquid Pipe	in (mm)	φ3/8 (φ9.5) (Flare connection)	φ3/8 (φ9.5) (Flare connection)
	Gas Pipe	in (mm)	φ5/8 (φ15.9) (Flare connection)	φ5/8 (φ15.9) (Flare connection)
	Drain Pipe	in (mm)	VP25 (External dia. 1-1/4 (32), internal dia. 1 (26))	VP25 (External dia. 1-1/4 (32), internal dia. 1 (26))
Remote controller (option)	Wired		BRC1E73, BRC2A71	BRC1E73, BRC2A71
	Wireless		—	—
Decoration panels (option)	Model		BYCQ125B-W1 / BYCQ125BGW1	BYCQ125B-W1 / BYCQ125BGW1
	Color		Fresh white	Fresh white
	Dimensions: (H×W×D)	in (mm)	2 × 37-3/8 × 37-3/8 / 5-1/8 × 37-3/8 × 37-3/8 (50 × 950 × 950 / 130 × 950 × 950)	2 × 37-3/8 × 37-3/8 / 5-1/8 × 37-3/8 × 37-3/8 (50 × 950 × 950 / 130 × 950 × 950)
	Air filter		Resin net (with mold resistance)	Resin net (with mold resistance)
	Weight	lbs (kg)	12.2 (5.5) / 22.1 (10.0)	12.2 (5.5) / 22.1 (10.0)
Outdoor unit			RZR30TAVJUA	RZR36TAVJUA
Casing color			Ivory white	Ivory white
Dimensions: (H×W×D)		in (mm)	52-15/16 × 35-7/16 × 12-5/8 (1,345 × 900 × 320)	52-15/16 × 35-7/16 × 12-5/8 (1,345 × 900 × 320)
Coil	Type		Cross fin coil	Cross fin coil
	Rows×Stages×FPI		2 × 60 × 19	2 × 60 × 19
	Face area	ft ² (m ²)	12.2 (1.134)	12.2 (1.134)
Compressor	Model		2YC90FXD#A	2YC90FXD#A
	Type		Hermetically sealed swing type	Hermetically sealed swing type
	Motor output	kW	3.5	3.5
Fan	Model		P47N	P47N
	Type		Propeller fan	Propeller fan
	Motor output	W	70 × 2	70 × 2
	Airflow rate	cfm (m ³ /min)	3,741 (106)	3,741 (106)
Weight		lbs (kg)	225 (102)	225 (102)
Sound pressure level		dB(A)	57	57
Connecting Pipes	Liquid Pipe	in (mm)	φ3/8 (φ9.5) (Flare connection)	φ3/8 (φ9.5) (Flare connection)
	Gas Pipe	in (mm)	φ5/8 (φ15.9) (Flare connection)	φ5/8 (φ15.9) (Flare connection)
	Drain Pipe	in (mm)	φ1 (φ26) (Hole)	φ1 (φ26) (Hole)
Safety devices			High pressure switch, Outdoor fan driver overload protector, Inverter overload protector, Fusible plugs, Fuse	High pressure switch, Outdoor fan driver overload protector, Inverter overload protector, Fusible plugs, Fuse
Capacity Control		%	14-100	14-100
Refrigerant control			Electronic expansion valve	Electronic expansion valve
Ref. piping	Standard length	ft (m)	25 (7.6)	25 (7.6)
	Max. length	ft (m)	230 (70)	230 (70)
	Max. height difference	ft (m)	98 (30)	98 (30)
Refrigerant	Model		R-410A	R-410A
	Charge	lbs (kg)	7.9 (3.6)	7.9 (3.6)
Ref. oil	Model		DAPHNE FVC50K	DAPHNE FVC50K
	Charge	L	1.52	1.52
Drawing No.	Specification		C: 4D126348	C: 4D126348
	Sound (indoor)		C: 4D087479B	C: 4D087475B
	Sound (outdoor)		C: 4D101949D	C: 4D101949D
Notes:				
★1 Indoor temp. : 80°FDB (26.7°CDB), 67°FWB (19.4°CWB) / outdoor temp. : 95°FDB (35.0°CDB) / Equivalent piping length : 25 ft (7.6 m), level difference : 0 ft (0 m).				
★2 Capacities are net, including a deduction for cooling for indoor fan motor heat.				

Model name	Indoor unit		FCQ42TAVJU	FCQ48TAVJU
	Outdoor unit		RZR42TAVJUA	RZR48TAVJUA
Power supply			1 phase, 208/230 V, 60 Hz	1 phase, 208/230 V, 60 Hz
★1 ★2 Cooling capacity	Btu/h (kW)		42,000 (12.3)	48,000 (14.1)
SEER (Rated)			17.0	17.0
EER (Rated)	Btu/h-W		10.3	9.0
Indoor unit			FCQ42TAVJU	FCQ48TAVJU
Casing color			Galvanized steel plate	Galvanized steel plate
Dimensions: (H×W×D)	in (mm)		11-23/32 × 33-1/16 × 33-1/16 (298 × 840 × 840)	11-23/32 × 33-1/16 × 33-1/16 (298 × 840 × 840)
Coil	Type		Cross fin coil	Cross fin coil
	Rows×Stages×FPI		3 × 18 × (20 + 21 × 2)	3 × 18 × (20 + 21 × 2)
	Face area	ft ² (m ²)	5.92 (0.550)	5.92 (0.550)
Fan	Model		QTS48C15M	QTS48C15M
	Type		Turbo fan	Turbo fan
	Motor output	W	106	106
	Airflow rate (H/M/L)	cfm (m ³ /min)	1,218/971/742 (34.5/27.5/21.0)	1,218/971/742 (34.5/27.5/21.0)
Sound pressure level (H/M/L)	dB(A)		45.0/40.0/35.0	45.0/40.0/35.0
Air filter			—	—
Weight	lbs (kg)		70 (31.5)	70 (31.5)
Connecting Pipes	Liquid Pipe	in (mm)	φ3/8 (φ9.5) (Flare connection)	φ3/8 (φ9.5) (Flare connection)
	Gas Pipe	in (mm)	φ5/8 (φ15.9) (Flare connection)	φ5/8 (φ15.9) (Flare connection)
	Drain Pipe	in (mm)	VP25 (External dia. 1-1/4 (32), internal dia. 1 (26))	VP25 (External dia. 1-1/4 (32), internal dia. 1 (26))
Remote controller (option)	Wired		BRC1E73, BRC2A71	BRC1E73, BRC2A71
	Wireless		—	—
Decoration panels (option)	Model		BYCQ125B-W1 / BYCQ125BGW1	BYCQ125B-W1 / BYCQ125BGW1
	Color		Fresh white	Fresh white
	Dimensions: (H×W×D)	in (mm)	2 × 37-3/8 × 37-3/8 / 5-1/8 × 37-3/8 × 37-3/8 (50 × 950 × 950 / 130 × 950 × 950)	2 × 37-3/8 × 37-3/8 / 5-1/8 × 37-3/8 × 37-3/8 (50 × 950 × 950 / 130 × 950 × 950)
	Air filter		Resin net (with mold resistance)	Resin net (with mold resistance)
	Weight	lbs (kg)	12.2 (5.5) / 22.1 (10.0)	12.2 (5.5) / 22.1 (10.0)
Outdoor unit			RZR42TAVJUA	RZR48TAVJUA
Casing color			Ivory white	Ivory white
Dimensions: (H×W×D)	in (mm)		52-15/16 × 35-7/16 × 12-5/8 (1,345 × 900 × 320)	52-15/16 × 35-7/16 × 12-5/8 (1,345 × 900 × 320)
Coil	Type		Cross fin coil	Cross fin coil
	Rows×Stages×FPI		2 × 60 × 19	2 × 60 × 19
	Face area	ft ² (m ²)	12.2 (1.134)	12.2 (1.134)
Compressor	Model		2YC90FXD#A	2YC90FXD#A
	Type		Hermetically sealed swing type	Hermetically sealed swing type
	Motor output	kW	3.5	3.5
Fan	Model		P47N	P47N
	Type		Propeller fan	Propeller fan
	Motor output	W	70 × 2	70 × 2
	Airflow rate	cfm (m ³ /min)	3,741 (106)	3,741 (106)
Weight	lbs (kg)		225 (102)	225 (102)
Sound pressure level	dB(A)		57	57
Connecting Pipes	Liquid Pipe	in (mm)	φ3/8 (φ9.5) (Flare connection)	φ3/8 (φ9.5) (Flare connection)
	Gas Pipe	in (mm)	φ5/8 (φ15.9) (Flare connection)	φ5/8 (φ15.9) (Flare connection)
	Drain Pipe	in (mm)	φ1 (φ26) (Hole)	φ1 (φ26) (Hole)
Safety devices			High pressure switch, Outdoor fan driver overload protector, Inverter overload protector, Fusible plugs, Fuse	High pressure switch, Outdoor fan driver overload protector, Inverter overload protector, Fusible plugs, Fuse
Capacity Control	%		14-100	14-100
Refrigerant control			Electronic expansion valve	Electronic expansion valve
Ref. piping	Standard length	ft (m)	25 (7.6)	25 (7.6)
	Max. length	ft (m)	230 (70)	230 (70)
	Max. height difference	ft (m)	98 (30)	98 (30)
Refrigerant	Model		R-410A	R-410A
	Charge	lbs (kg)	7.9 (3.6)	7.9 (3.6)
Ref. oil	Model		DAPHNE FVC50K	DAPHNE FVC50K
	Charge	L	1.52	1.52
Drawing No.	Specification		C: 4D126348	C: 4D126348
	Sound (indoor)		C: 4D087476B	C: 4D087476B
	Sound (outdoor)		C: 4D101949D	C: 4D101949D
Notes:				
★1 Indoor temp. : 80°FDB (26.7°CDB), 67°FWB (19.4°CWB) / outdoor temp. : 95°FDB (35.0°CDB) / Equivalent piping length : 25 ft (7.6 m), level difference : 0 ft (0 m).				
★2 Capacities are net, including a deduction for cooling for indoor fan motor heat.				

Model name		Indoor unit	FCQ18AAVJU	FCQ24AAVJU
		Outdoor unit	RZR18TBVJUA	RZR24TBVJUA
Power supply			1 phase, 208/230 V, 60 Hz	1 phase, 208/230 V, 60 Hz
★1 ★2 Cooling capacity	Btu/h (kW)		18,000 (5.3)	24,000 (7.0)
Indoor unit			FCQ18AAVJU	FCQ24AAVJU
Casing color			Galvanized steel plate	Galvanized steel plate
Dimensions: (H×W×D)		in (mm)	9-11/16 × 33-1/16 × 33-1/16 (246 × 840 × 840)	9-11/16 × 33-1/16 × 33-1/16 (246 × 840 × 840)
Coil	Type		Cross fin coil	Cross fin coil
Fan	Type		Turbo fan	Turbo fan
	Motor output	W	53	53
	Airflow rate (H/M/L)	cfm (m³/min)	742/618/477 (21.0/17.5/13.5)	777/618/477 (22.0/17.5/13.5)
Sound pressure level (H/M/L)		dB(A)	38.0/32.0/28.0	38.0/32.0/28.0
Air filter			—	—
Weight		lbs (kg)	51 (23)	51 (23)
Connecting Pipes	Liquid Pipe	in (mm)	φ3/8 (φ9.5) (Flare connection)	φ3/8 (φ9.5) (Flare connection)
	Gas Pipe	in (mm)	φ5/8 (φ15.9) (Flare connection)	φ5/8 (φ15.9) (Flare connection)
	Drain Pipe	in (mm)	VP25 (External dia. 1-1/4 (32), internal dia. 1 (26))	VP25 (External dia. 1-1/4 (32), internal dia. 1 (26))
Remote controller (accessory)	Wired		BRC1E73, BRC1H71W	BRC1E73, BRC1H71W
	Wireless		—	—
Decoration panels (accessory)	Model		BYCQ54EEFU / BYCQ54EEGFU	BYCQ54EEFU / BYCQ54EEGFU
	Color		Fresh white	Fresh white
	Dimensions: (H×W×D)	in (mm)	2 × 37-3/8 × 37-3/8 / 5-1/8 × 37-3/8 × 37-3/8 (50 × 950 × 950 / 130 × 950 × 950)	2 × 37-3/8 × 37-3/8 / 5-1/8 × 37-3/8 × 37-3/8 (50 × 950 × 950 / 130 × 950 × 950)
	Air filter		Resin net (with mold resistance)	Resin net (With mold resistance)
	Weight	lbs (kg)	12 (5.5) / 22 (10.0)	12 (5.5) / 22 (10.0)
Outdoor unit			RZR18TBVJUA	RZR24TBVJUA
Casing color			Ivory white	Ivory white
Dimensions: (H×W×D)		in (mm)	39 × 37 × 12-5/8 (990 × 940 × 320)	39 × 37 × 12-5/8 (990 × 940 × 320)
Coil	Type		Cross fin coil	Cross fin coil
Compressor	Type		Hermetically sealed swing type	Hermetically sealed swing type
	Motor output	kW	1.9	1.9
Fan	Type		Propeller fan	Propeller fan
	Motor output	W	200	200
	Airflow rate	cfm (m³/min)	2,682 (76)	2,682 (76)
Weight		lbs (kg)	172 (78)	172 (78)
Sound pressure level		dB(A)	58	58
Connecting Pipes	Liquid Pipe	in (mm)	φ3/8 (φ9.5) (Flare connection)	φ3/8 (φ9.5) (Flare connection)
	Gas Pipe	in (mm)	φ5/8 (φ15.9) (Flare connection)	φ5/8 (φ15.9) (Flare connection)
	Drain Pipe	in (mm)	φ1 (φ26) (Hole)	φ1 (φ26) (Hole)
Safety devices			High pressure switch, Outdoor fan driver overload protector, Inverter overload protector, Fusible plug, Fuse	High pressure switch, Outdoor fan driver overload protector, Inverter overload protector, Fusible plug, Fuse
Capacity step	%		14-100	14-100
Refrigerant control			Electronic expansion valve	Electronic expansion valve
Ref. piping	Standard length	ft (m)	25 (7.6)	25 (7.6)
	Max. length	ft (m)	164 (50)	164 (50)
	Max. height difference	ft (m)	98 (30)	98 (30)
Refrigerant	Type		R-410A	R-410A
	Charge	lbs (kg)	6.4 (2.9)	6.4 (2.9)
Ref. oil	Type		DAPHNE FVC50K	DAPHNE FVC50K
	Charge	L	1.08	1.08
Drawing No.	Specification		4D143003B	4D143003B
	Sound (indoor)		4D140998	4D140998
	Sound (outdoor)		4D101947D	4D101947D
Notes:				
★1 Indoor temp. : 80°FDB (26.7°CDB), 67°FWB (19.4°CWB) / outdoor temp. : 95°FDB (35.0°CDB) / Equivalent piping length : 25 ft (7.6 m), height difference : 0 ft (0 m).				
★2 Capacities are net, including a deduction for cooling for indoor fan motor heat.				

Model name		Indoor unit		FCQ30AAVJU		FCQ36AAVJU	
		Outdoor unit		RZR30TBVJUA		RZR36TBVJUA	
Power supply				1 phase, 208/230 V, 60 Hz		1 phase, 208/230 V, 60 Hz	
★1 ★2 Cooling capacity		Btu/h (kW)		30,000 (8.8)		36,000 (10.6)	
Indoor unit				FCQ30AAVJU		FCQ36AAVJU	
Casing color				Galvanized steel plate		Galvanized steel plate	
Dimensions: (H×W×D)		in (mm)		11-11/32 × 33-1/16 × 33-1/16 (288 × 840 × 840)		11-11/32 × 33-1/16 × 33-1/16 (288 × 840 × 840)	
Coil	Type			Cross fin coil		Cross fin coil	
Fan	Type			Turbo fan		Turbo fan	
	Motor output	W		106		106	
	Airflow rate (H/M/L)	cfm (m ³ /min)		1,059/882/671 (30.0/25.0/19.0)		1,253/918/671 (35.5/26.0/19.0)	
Sound pressure level (H/M/L)		dB(A)		42.0/37.0/32.0		47.0/38.0/32.0	
Air filter				—		—	
Weight		lbs (kg)		58 (26)		58 (26)	
Connecting Pipes	Liquid Pipe	in (mm)		φ3/8 (φ9.5) (Flare connection)		φ3/8 (φ9.5) (Flare connection)	
	Gas Pipe	in (mm)		φ5/8 (φ15.9) (Flare connection)		φ5/8 (φ15.9) (Flare connection)	
	Drain Pipe	in (mm)		VP25 (External dia. 1-1/4 (32), internal dia. 1 (26))		VP25 (External dia. 1-1/4 (32), internal dia. 1 (26))	
Remote controller (accessory)	Wired			BRC1E73, BRC1H71W		BRC1E73, BRC1H71W	
	Wireless			—		—	
Decoration panels (accessory)	Model			BYCQ54EEFU / BYCQ54EEGFU		BYCQ54EEFU / BYCQ54EEGFU	
	Color			Fresh white		Fresh white	
	Dimensions: (H×W×D)	in (mm)		2 × 37-3/8 × 37-3/8 / 5-1/8 × 37-3/8 × 37-3/8 (50 × 950 × 950 / 130 × 950 × 950)		2 × 37-3/8 × 37-3/8 / 5-1/8 × 37-3/8 × 37-3/8 (50 × 950 × 950 / 130 × 950 × 950)	
	Air filter			Resin net (with mold resistance)		Resin net (with mold resistance)	
	Weight	lbs (kg)		12 (5.5) / 22 (10.0)		12 (5.5) / 22 (10.0)	
Outdoor unit				RZR30TBVJUA		RZR36TBVJUA	
Casing color				Ivory white		Ivory white	
Dimensions: (H×W×D)		in (mm)		52-15/16 × 35-7/16 × 12-5/8 (1,345 × 900 × 320)		52-15/16 × 35-7/16 × 12-5/8 (1,345 × 900 × 320)	
Coil	Type			Cross fin coil		Cross fin coil	
Compressor	Type			Hermetically sealed swing type		Hermetically sealed swing type	
	Motor output	kW		3.5		3.5	
Fan	Type			Propeller fan		Propeller fan	
	Motor output	W		70 × 2		70 × 2	
	Airflow rate	cfm (m ³ /min)		3,741 (106)		3,741 (106)	
Weight		lbs (kg)		225 (102)		225 (102)	
Sound pressure level		dB(A)		57		57	
Connecting Pipes	Liquid Pipe	in (mm)		φ3/8 (φ9.5) (Flare connection)		φ3/8 (φ9.5) (Flare connection)	
	Gas Pipe	in (mm)		φ5/8 (φ15.9) (Flare connection)		φ5/8 (φ15.9) (Flare connection)	
	Drain Pipe	in (mm)		φ1 (φ26) (Hole)		φ1 (φ26) (Hole)	
Safety devices				High pressure switch, Outdoor fan driver overload protector, Inverter overload protector, Fusible plug, Fuse		High pressure switch, Outdoor fan driver overload protector, Inverter overload protector, Fusible plug, Fuse	
Capacity step		%		14-100		14-100	
Refrigerant control				Electronic expansion valve		Electronic expansion valve	
Ref. piping	Standard length	ft (m)		25 (7.6)		25 (7.6)	
	Max. length	ft (m)		230 (70)		230 (70)	
	Max. height difference	ft (m)		98 (30)		98 (30)	
Refrigerant	Type			R-410A		R-410A	
	Charge	lbs (kg)		7.9 (3.6)		7.9 (3.6)	
Ref. oil	Type			DAPHNE FVC50K		DAPHNE FVC50K	
	Charge	L		1.52		1.52	
Drawing No.	Specification			4D143004B		4D143004B	
	Sound (indoor)			4D140999		4D141000	
	Sound (outdoor)			4D101949D		4D101949D	
Notes:							
★1 Indoor temp. : 80°FDB (26.7°CDB), 67°FWB (19.4°CWB) / outdoor temp. : 95°FDB (35.0°CDB) / Equivalent piping length : 25 ft (7.6 m), height difference : 0 ft (0 m).							
★2 Capacities are net, including a deduction for cooling for indoor fan motor heat.							

Model name		Indoor unit		FCQ42AAVJU		FCQ48AAVJU	
		Outdoor unit		RZR42TBVJUA		RZR48TBVJUA	
Power supply				1 phase, 208/230 V, 60 Hz		1 phase, 208/230 V, 60 Hz	
★1 ★2 Cooling capacity		Btu/h (kW)		42,000 (12.3)		48,000 (14.1)	
Indoor unit				FCQ42AAVJU		FCQ48AAVJU	
Casing color				Galvanized steel plate		Galvanized steel plate	
Dimensions: (H×W×D)		in (mm)		11-11/32 × 33-1/16 × 33-1/16 (288 × 840 × 840)		11-11/32 × 33-1/16 × 33-1/16 (288 × 840 × 840)	
Coil	Type			Cross fin coil		Cross fin coil	
Fan	Type			Turbo fan		Turbo fan	
	Motor output	W		106		106	
	Airflow rate (H/M/L)	cfm (m³/min)		1,253/971/741 (35.5/27.5/21.0)		1,253/971/741 (35.5/27.5/21.0)	
Sound pressure level (H/M/L)		dB(A)		47.0/40.0/35.0		47.0/40.0/35.0	
Air filter				—		—	
Weight		lbs (kg)		58 (26)		58 (26)	
Connecting Pipes	Liquid Pipe	in (mm)		φ3/8 (φ9.5) (Flare connection)		φ3/8 (φ9.5) (Flare connection)	
	Gas Pipe	in (mm)		φ5/8 (φ15.9) (Flare connection)		φ5/8 (φ15.9) (Flare connection)	
	Drain Pipe	in (mm)		VP25 (External dia. 1-1/4 (32), internal dia. 1 (26))		VP25 (External dia. 1-1/4 (32), internal dia. 1 (26))	
Remote controller (accessory)	Wired			BRC1E73, BRC1H71W		BRC1E73, BRC1H71W	
	Wireless			—		—	
Decoration panels (accessory)	Model			BYCQ54EEFU / BYCQ54EEGFU		BYCQ54EEFU / BYCQ54EEGFU	
	Color			Fresh white		Fresh white	
	Dimensions: (H×W×D)	in (mm)		2 × 37-3/8 × 37-3/8 / 5-1/8 × 37-3/8 × 37-3/8 (50 × 950 × 950 / 130 × 950 × 950)		2 × 37-3/8 × 37-3/8 / 5-1/8 × 37-3/8 × 37-3/8 (50 × 950 × 950 / 130 × 950 × 950)	
	Air filter			Resin net (with mold resistance)		Resin net (with mold resistance)	
	Weight	lbs (kg)		12 (5.5) / 22 (10.0)		12 (5.5) / 22 (10.0)	
Outdoor unit				RZR42TBVJUA		RZR48TBVJUA	
Casing color				Ivory white		Ivory white	
Dimensions: (H×W×D)		in (mm)		52-15/16 × 35-7/16 × 12-5/8 (1,345 × 900 × 320)		52-15/16 × 35-7/16 × 12-5/8 (1,345 × 900 × 320)	
Coil	Type			Cross fin coil		Cross fin coil	
Compressor	Type			Hermetically sealed swing type		Hermetically sealed swing type	
	Motor output	kW		3.5		3.5	
Fan	Type			Propeller fan		Propeller fan	
	Motor output	W		70 × 2		70 × 2	
	Airflow rate	cfm (m³/min)		3,741 (106)		3,741 (106)	
Weight		lbs (kg)		225 (102)		225 (102)	
Sound pressure level		dB(A)		57		57	
Connecting Pipes	Liquid Pipe	in (mm)		φ3/8 (φ9.5) (Flare connection)		φ3/8 (φ9.5) (Flare connection)	
	Gas Pipe	in (mm)		φ5/8 (φ15.9) (Flare connection)		φ5/8 (φ15.9) (Flare connection)	
	Drain Pipe	in (mm)		φ1 (φ26) (Hole)		φ1 (φ26) (Hole)	
Safety devices				High pressure switch, Outdoor fan driver overload protector, Inverter overload protector, Fusible plug, Fuse		High pressure switch, Outdoor fan driver overload protector, Inverter overload protector, Fusible plug, Fuse	
Capacity step		%		14-100		14-100	
Refrigerant control				Electronic expansion valve		Electronic expansion valve	
Ref. piping	Standard length	ft (m)		25 (7.6)		25 (7.6)	
	Max. length	ft (m)		230 (70)		230 (70)	
	Max. height difference	ft (m)		98 (30)		98 (30)	
Refrigerant	Type			R-410A		R-410A	
	Charge	lbs (kg)		7.9 (3.6)		7.9 (3.6)	
Ref. oil	Type			DAPHNE FVC50K		DAPHNE FVC50K	
	Charge	L		1.52		1.52	
Drawing No.	Specification			4D143004B		4D143004B	
	Sound (indoor)			4D141001		4D141001	
	Sound (outdoor)			4D101949D		4D101949D	
Notes:							
★1 Indoor temp. : 80°FDB (26.7°CDB), 67°FWB (19.4°CWB) / outdoor temp. : 95°FDB (35.0°CDB) / Equivalent piping length : 25 ft (7.6 m), height difference : 0 ft (0 m).							
★2 Capacities are net, including a deduction for cooling for indoor fan motor heat.							

3.1.2 Ceiling Suspended Type

Model name	Indoor unit		FHQ18PVJU	FHQ24PVJU
	Outdoor unit		RZR18TAVJU	RZR24TAVJU
Power supply			1 phase, 208/230 V, 60 Hz	1 phase, 208/230 V, 60 Hz
★1 ★2 Cooling capacity	Btu/h (kW)		18,000 (5.3)	24,000 (7.0)
SEER (Rated)			16.3	16.6
EER (Rated)	Btu/h-W		12.9	11.3
Indoor unit			FHQ18PVJU	FHQ24PVJU
Casing color			White (10Y9/0.5)	White (10Y9/0.5)
Dimensions: (H×W×D)	in (mm)		7-11/16 × 62-5/8 × 26-3/4 (195 × 1,590 × 680)	7-11/16 × 62-5/8 × 26-3/4 (195 × 1,590 × 680)
Coil	Type		Cross fin coil	Cross fin coil
	Rows×Stages×FPI		2 × 12 × 15 + 2 × 10 × 15	2 × 12 × 15 + 2 × 10 × 15
	Face area	ft ² (m ²)	3.66 (0.34) + 2.95 (0.27)	3.66 (0.34) + 2.95 (0.27)
Fan	Model		—	—
	Type		Sirocco fan	Sirocco fan
	Motor output	W	130	130
	Airflow rate (H/L)	cfm (m ³ /min)	790/670 (22.4/19.0)	790/670 (22.4/19.0)
Air filter			Resin net (with mold resistance)	Resin net (with mold resistance)
Weight	lbs (kg)		90 (19.8)	90 (19.8)
Connecting Pipes	Liquid Pipe	in (mm)	φ3/8 (φ9.5) (Flare connection)	φ3/8 (φ9.5) (Flare connection)
	Gas Pipe	in (mm)	φ5/8 (φ15.9) (Flare connection)	φ5/8 (φ15.9) (Flare connection)
	Drain Pipe	in (mm)	VP20 (External dia. 1 (26), internal dia. 3/4 (19.1))	VP20 (External dia. 1 (26), internal dia. 3/4 (19.1))
Remote controller (option)	Wired		BRC1E73	BRC1E73
	Wireless		BRC7E83	BRC7E83
Outdoor unit			RZR18TAVJU	RZR24TAVJU
Casing color			Ivory white	Ivory white
Dimensions: (H×W×D)	in (mm)		39 × 37 × 12-5/8 (990 × 940 × 320)	39 × 37 × 12-5/8 (990 × 940 × 320)
Coil	Type		Cross fin coil	Cross fin coil
	Rows×Stages×FPI		2 × 44 × 19	2 × 44 × 19
	Face area	ft ² (m ²)	9.5 (0.88)	9.5 (0.88)
Compressor	Model		2YC63ABXDD	2YC63ABXDD
	Type		Hermetically sealed swing type	Hermetically sealed swing type
	Motor output	kW	1.9	1.9
Fan	Model		P51J11F	P51J11F
	Type		Propeller fan	Propeller fan
	Motor output	W	200	200
	Airflow rate	cfm (m ³ /min)	2,682 (76)	2,682 (76)
Weight	lbs (kg)		172 (78)	172 (78)
Sound pressure level	dB(A)		58	58
Connecting Pipes	Liquid Pipe	in (mm)	φ3/8 (φ9.5) (Flare connection)	φ3/8 (φ9.5) (Flare connection)
	Gas Pipe	in (mm)	φ5/8 (φ15.9) (Flare connection)	φ5/8 (φ15.9) (Flare connection)
	Drain Pipe	in (mm)	φ1 (φ26) (Hole)	φ1 (φ26) (Hole)
Safety devices			High pressure switch, Outdoor fan driver overload protector, Inverter overload protector, Fusible plugs, Fuse	High pressure switch, Outdoor fan driver overload protector, Inverter overload protector, Fusible plugs, Fuse
Capacity Control	%		14-100	14-100
Refrigerant control			Electronic expansion valve	Electronic expansion valve
Ref. piping	Standard length	ft (m)	25 (7.6)	25 (7.6)
	Max. length	ft (m)	164 (50)	164 (50)
	Max. height difference	ft (m)	98 (30)	98 (30)
Refrigerant	Model		R-410A	R-410A
	Charge	lbs (kg)	6.4 (2.9)	6.4 (2.9)
Ref. oil	Model		DAPHNE FVC50K	DAPHNE FVC50K
	Charge	L	1.08	1.08
Drawing No.	Specification		C: 4D115558A	C: 4D115558A
	Sound (outdoor)		C: 4D101947D	C: 4D101947D

Notes:
★1 Indoor temp. : 80°FDB (26.7°CDB), 67°FWB (19.4°CWB) / outdoor temp. : 95°FDB (35.0°CDB) / Equivalent piping length : 25 ft (7.6 m), level difference : 0 ft (0 m).
★2 Capacities are net, including a deduction for cooling for indoor fan motor heat.

Model name		Indoor unit	FHQ30PVJU	FHQ36MVJU
		Outdoor unit	RZR30TAVJU	RZR36TAVJU
Power supply			1 phase, 208/230 V, 60 Hz	1 phase, 208/230 V, 60 Hz
★1 ★2 Cooling capacity	Btu/h (kW)		30,000 (8.8)	36,000 (10.6)
SEER (Rated)			16.0	14.0
EER (Rated)	Btu/h-W		10.5	9.5
Indoor unit			FHQ30PVJU	FHQ36MVJU
Casing color			White (10Y9/0.5)	White (10Y9/0.5)
Dimensions: (H×W×D)		in (mm)	7-11/16 × 62-5/8 × 26-3/4 (195 × 1,590 × 680)	7-11/16 × 62-5/8 × 26-3/4 (195 × 1,590 × 680)
Coil	Type		Cross fin coil	Cross fin coil
	Rows×Stages×FPI		2 × 12 × 15 + 2 × 10 × 15	2 × 12 × 15 + 2 × 10 × 15
	Face area	ft ² (m ²)	3.66 (0.34) + 2.95 (0.27)	3.66 (0.34) + 2.95 (0.27)
Fan	Model		—	—
	Type		Sirocco fan	Sirocco fan
	Motor output	W	130	130
	Airflow rate (H/L)	cfm (m ³ /min)	790/670 (22.4/19.0)	830/670 (23.5/19.0)
Air filter			Resin net (with mold resistance)	Resin net (with mold resistance)
Weight		lbs (kg)	90 (19.8)	90 (19.8)
Connecting Pipes	Liquid Pipe	in (mm)	φ3/8 (φ9.5) (Flare connection)	φ3/8 (φ9.5) (Flare connection)
	Gas Pipe	in (mm)	φ5/8 (φ15.9) (Flare connection)	φ5/8 (φ15.9) (Flare connection)
	Drain Pipe	in (mm)	VP20 (External dia. 1 (26), internal dia. 3/4 (19.1))	VP20 (External dia. 1 (26), internal dia. 3/4 (19.1))
Remote controller (option)	Wired		BRC1E73	BRC1E73
	Wireless		BRC7E83	BRC7E83
Outdoor unit			RZR30TAVJU	RZR36TAVJU
Casing color			Ivory white	Ivory white
Dimensions: (H×W×D)		in (mm)	52-15/16 × 35-7/16 × 12-5/8 (1,345 × 900 × 320)	52-15/16 × 35-7/16 × 12-5/8 (1,345 × 900 × 320)
Coil	Type		Cross fin coil	Cross fin coil
	Rows×Stages×FPI		2 × 60 × 19	2 × 60 × 19
	Face area	ft ² (m ²)	12.2 (1.134)	12.2 (1.134)
Compressor	Model		2YC90GXD#D	2YC90GXD#D
	Type		Hermetically sealed swing type	Hermetically sealed swing type
	Motor output	kW	3.5	3.5
Fan	Model		P47N	P47N
	Type		Propeller fan	Propeller fan
	Motor output	W	70 × 2	70 × 2
	Airflow rate	cfm (m ³ /min)	3,741 (106)	3,741 (106)
Weight		lbs (kg)	225 (102)	225 (102)
Sound pressure level		dB(A)	57	57
Connecting Pipes	Liquid Pipe	in (mm)	φ3/8 (φ9.5) (Flare connection)	φ3/8 (φ9.5) (Flare connection)
	Gas Pipe	in (mm)	φ5/8 (φ15.9) (Flare connection)	φ5/8 (φ15.9) (Flare connection)
	Drain Pipe	in (mm)	φ1 (φ26) (Hole)	φ1 (φ26) (Hole)
Safety devices			High pressure switch, Outdoor fan driver overload protector, Inverter overload protector, Fusible plugs, Fuse	High pressure switch, Outdoor fan driver overload protector, Inverter overload protector, Fusible plugs, Fuse
Capacity Control		%	14-100	14-100
Refrigerant control			Electronic expansion valve	Electronic expansion valve
Ref. piping	Standard length	ft (m)	25 (7.6)	25 (7.6)
	Max. length	ft (m)	230 (70)	230 (70)
	Max. height difference	ft (m)	98 (30)	98 (30)
Refrigerant	Model		R-410A	R-410A
	Charge	lbs (kg)	7.9 (3.6)	7.9 (3.6)
Ref. oil	Model		DAPHNE FVC50K	DAPHNE FVC50K
	Charge	L	1.52	1.52
Drawing No.	Specification		C: 4D115560A	C: 4D115560A
	Sound (outdoor)		C: 4D101949D	C: 4D101949D
Notes:				
★1 Indoor temp. : 80°FDB (26.7°CDB), 67°FWB (19.4°CWB) / outdoor temp. : 95°FDB (35.0°CDB) / Equivalent piping length : 25 ft (7.6 m), level difference : 0 ft (0 m).				
★2 Capacities are net, including a deduction for cooling for indoor fan motor heat.				

Model name		Indoor unit	FHQ42MVJU
		Outdoor unit	RZR42TAVJU
Power supply			1 phase, 208/230 V, 60 Hz
★1 ★2 Cooling capacity	Btu/h (kW)		40,500 (11.9)
SEER (Rated)			14.0
EER (Rated)	Btu/h-W		8.8
Indoor unit			FHQ42MVJU
Casing color			White (10Y9/0.5)
Dimensions: (H×W×D)		in (mm)	7-11/16 × 62-5/8 × 26-3/4 (195 × 1,590 × 680)
Coil	Type		Cross fin coil
	Rows×Stages×FPI		2 × 12 × 15 + 2 × 10 × 15
	Face area	ft ² (m ²)	3.66 (0.34) + 2.95 (0.27)
Fan	Model		—
	Type		Sirocco fan
	Motor output	W	130
	Airflow rate (H/L)	cfm (m ³ /min)	850/700 (24.1/19.8)
Air filter			Resin net (with mold resistance)
Weight		lbs (kg)	90 (19.8)
Connecting Pipes	Liquid Pipe	in (mm)	φ3/8 (φ9.5) (Flare connection)
	Gas Pipe	in (mm)	φ5/8 (φ15.9) (Flare connection)
	Drain Pipe	in (mm)	VP20 (External dia. 1 (26), internal dia. 3/4 (19.1))
Remote controller (option)	Wired		BRC1E73
	Wireless		BRC7E83
Outdoor unit			RZR42TAVJU
Casing color			Ivory white
Dimensions: (H×W×D)		in (mm)	52-15/16 × 35-7/16 × 12-5/8 (1,345 × 900 × 320)
Coil	Type		Cross fin coil
	Rows×Stages×FPI		2 × 60 × 19
	Face area	ft ² (m ²)	12.2 (1.134)
Compressor	Model		2YC90GXD#D
	Type		Hermetically sealed swing type
	Motor output	kW	3.5
Fan	Model		P47N
	Type		Propeller fan
	Motor output	W	70 × 2
	Airflow rate	cfm (m ³ /min)	3,741 (106)
Weight		lbs (kg)	225 (102)
Sound pressure level		dB(A)	57
Connecting Pipes	Liquid Pipe	in (mm)	φ3/8 (φ9.5) (Flare connection)
	Gas Pipe	in (mm)	φ5/8 (φ15.9) (Flare connection)
	Drain Pipe	in (mm)	φ1 (φ26) (Hole)
Safety devices			High pressure switch, Outdoor fan driver overload protector, Inverter overload protector, Fusible plugs, Fuse
Capacity Control		%	14-100
Refrigerant control			Electronic expansion valve
Ref. piping	Standard length	ft (m)	25 (7.6)
	Max. length	ft (m)	230 (70)
	Max. height difference	ft (m)	98 (30)
Refrigerant	Model		R-410A
	Charge	lbs (kg)	7.9 (3.6)
Ref. oil	Model		DAPHNE FVC50K
	Charge	L	1.52
Drawing No.	Specification		C: 4D115560A
	Sound (outdoor)		C: 4D101949D
Notes:			
★1 Indoor temp. : 80°FDB (26.7°CDB), 67°FWB (19.4°CWB) / outdoor temp. : 95°FDB (35.0°CDB) / Equivalent piping length : 25 ft (7.6 m), level difference : 0 ft (0 m).			
★2 Capacities are net, including a deduction for cooling for indoor fan motor heat.			

Model name	Indoor unit		FHQ18PVJU	FHQ24PVJU
	Outdoor unit		RZR18TAVJUA	RZR24TAVJUA
Power supply			1 phase, 208/230 V, 60 Hz	1 phase, 208/230 V, 60 Hz
★1 ★2 Cooling capacity	Btu/h (kW)		18,000 (5.3)	24,000 (7.0)
SEER (Rated)			16.3	16.6
EER (Rated)	Btu/h-W		12.9	11.3
Indoor unit			FHQ18PVJU	FHQ24PVJU
Casing color			White (10Y9/0.5)	White (10Y9/0.5)
Dimensions: (H×W×D)			in (mm) 7-11/16 × 62-5/8 × 26-3/4 (195 × 1,590 × 680)	7-11/16 × 62-5/8 × 26-3/4 (195 × 1,590 × 680)
Coil	Type		Cross fin coil	Cross fin coil
	Rows×Stages×FPI		2 × 12 × 15 + 2 × 10 × 15	2 × 12 × 15 + 2 × 10 × 15
	Face area	ft ² (m ²)	3.66 (0.34) + 2.95 (0.27)	3.66 (0.34) + 2.95 (0.27)
Fan	Model		—	—
	Type		Sirocco fan	Sirocco fan
	Motor output	W	130	130
	Airflow rate (H/L)	cfm (m ³ /min)	790/670 (22.4/19.0)	790/670 (22.4/19.0)
Air filter			Resin net (with mold resistance)	Resin net (with mold resistance)
Weight			lbs (kg) 90 (19.8)	90 (19.8)
Connecting Pipes	Liquid Pipe	in (mm)	φ3/8 (φ9.5) (Flare connection)	φ3/8 (φ9.5) (Flare connection)
	Gas Pipe	in (mm)	φ5/8 (φ15.9) (Flare connection)	φ5/8 (φ15.9) (Flare connection)
	Drain Pipe	in (mm)	VP20 (External dia. 1 (26), internal dia. 3/4 (19.1))	VP20 (External dia. 1 (26), internal dia. 3/4 (19.1))
Remote controller (option)	Wired		BRC1E73	BRC1E73
	Wireless		BRC7E83	BRC7E83
Outdoor unit			RZR18TAVJUA	RZR24TAVJUA
Casing color			Ivory white	Ivory white
Dimensions: (H×W×D)			in (mm) 39 × 37 × 12-5/8 (990 × 940 × 320)	39 × 37 × 12-5/8 (990 × 940 × 320)
Coil	Type		Cross fin coil	Cross fin coil
	Rows×Stages×FPI		2 × 44 × 19	2 × 44 × 19
	Face area	ft ² (m ²)	9.5 (0.88)	9.5 (0.88)
Compressor	Model		2YC63TXD#A	2YC63TXD#A
	Type		Hermetically sealed swing type	Hermetically sealed swing type
	Motor output	kW	1.9	1.9
Fan	Model		P51J11F	P51J11F
	Type		Propeller fan	Propeller fan
	Motor output	W	200	200
	Airflow rate	cfm (m ³ /min)	2,682 (76)	2,682 (76)
Weight			lbs (kg) 172 (78)	172 (78)
Sound pressure level			dB(A) 58	58
Connecting Pipes	Liquid Pipe	in (mm)	φ3/8 (φ9.5) (Flare connection)	φ3/8 (φ9.5) (Flare connection)
	Gas Pipe	in (mm)	φ5/8 (φ15.9) (Flare connection)	φ5/8 (φ15.9) (Flare connection)
	Drain Pipe	in (mm)	φ1 (φ26) (Hole)	φ1 (φ26) (Hole)
Safety devices			High pressure switch, Outdoor fan driver overload protector, Inverter overload protector, Fusible plugs, Fuse	High pressure switch, Outdoor fan driver overload protector, Inverter overload protector, Fusible plugs, Fuse
Capacity Control			% 14-100	14-100
Refrigerant control			Electronic expansion valve	Electronic expansion valve
Ref. piping	Standard length	ft (m)	25 (7.6)	25 (7.6)
	Max. length	ft (m)	164 (50)	164 (50)
	Max. height difference	ft (m)	98 (30)	98 (30)
Refrigerant	Model		R-410A	R-410A
	Charge	lbs (kg)	6.4 (2.9)	6.4 (2.9)
Ref. oil	Model		DAPHNE FVC50K	DAPHNE FVC50K
	Charge	L	1.08	1.08
Drawing No.	Specification		C: 4D126355	C: 4D126355
	Sound (outdoor)		C: 4D101947D	C: 4D101947D
Notes:				
★1 Indoor temp. : 80°FDB (26.7°CDB), 67°FWB (19.4°CWB) / outdoor temp. : 95°FDB (35.0°CDB) / Equivalent piping length : 25 ft (7.6 m), level difference : 0 ft (0 m).				
★2 Capacities are net, including a deduction for cooling for indoor fan motor heat.				

Model name		Indoor unit	FHQ30PVJU	FHQ36MVJU
		Outdoor unit	RZR30TAVJUA	RZR36TAVJUA
Power supply			1 phase, 208/230 V, 60 Hz	1 phase, 208/230 V, 60 Hz
★1 ★2 Cooling capacity	Btu/h (kW)		30,000 (8.8)	36,000 (10.6)
SEER (Rated)			16.0	14.0
EER (Rated)	Btu/h-W		10.5	9.5
Indoor unit			FHQ30PVJU	FHQ36MVJU
Casing color			White (10Y9/0.5)	White (10Y9/0.5)
Dimensions: (H×W×D)		in (mm)	7-11/16 × 62-5/8 × 26-3/4 (195 × 1,590 × 680)	7-11/16 × 62-5/8 × 26-3/4 (195 × 1,590 × 680)
Coil	Type		Cross fin coil	Cross fin coil
	Rows×Stages×FPI		2 × 12 × 15 + 2 × 10 × 15	2 × 12 × 15 + 2 × 10 × 15
	Face area	ft ² (m ²)	3.66 (0.34) + 2.95 (0.27)	3.66 (0.34) + 2.95 (0.27)
Fan	Model		—	—
	Type		Sirocco fan	Sirocco fan
	Motor output	W	130	130
	Airflow rate (H/L)	cfm (m ³ /min)	790/670 (22.4/19.0)	830/670 (23.5/19.0)
Air filter			Resin net (with mold resistance)	Resin net (with mold resistance)
Weight		lbs (kg)	90 (19.8)	90 (19.8)
Connecting Pipes	Liquid Pipe	in (mm)	φ3/8 (φ9.5) (Flare connection)	φ3/8 (φ9.5) (Flare connection)
	Gas Pipe	in (mm)	φ5/8 (φ15.9) (Flare connection)	φ5/8 (φ15.9) (Flare connection)
	Drain Pipe	in (mm)	VP20 (External dia. 1 (26), internal dia. 3/4 (19.1))	VP20 (External dia. 1 (26), internal dia. 3/4 (19.1))
Remote controller (option)	Wired		BRC1E73	BRC1E73
	Wireless		BRC7E83	BRC7E83
Outdoor unit			RZR30TAVJUA	RZR36TAVJUA
Casing color			Ivory white	Ivory white
Dimensions: (H×W×D)		in (mm)	52-15/16 × 35-7/16 × 12-5/8 (1,345 × 900 × 320)	52-15/16 × 35-7/16 × 12-5/8 (1,345 × 900 × 320)
Coil	Type		Cross fin coil	Cross fin coil
	Rows×Stages×FPI		2 × 60 × 19	2 × 60 × 19
	Face area	ft ² (m ²)	12.2 (1.134)	12.2 (1.134)
Compressor	Model		2YC90FXD#A	2YC90FXD#A
	Type		Hermetically sealed swing type	Hermetically sealed swing type
	Motor output	kW	3.5	3.5
Fan	Model		P47N	P47N
	Type		Propeller fan	Propeller fan
	Motor output	W	70 × 2	70 × 2
	Airflow rate	cfm (m ³ /min)	3,741 (106)	3,741 (106)
Weight		lbs (kg)	225 (102)	225 (102)
Sound pressure level		dB(A)	57	57
Connecting Pipes	Liquid Pipe	in (mm)	φ3/8 (φ9.5) (Flare connection)	φ3/8 (φ9.5) (Flare connection)
	Gas Pipe	in (mm)	φ5/8 (φ15.9) (Flare connection)	φ5/8 (φ15.9) (Flare connection)
	Drain Pipe	in (mm)	φ1 (φ26) (Hole)	φ1 (φ26) (Hole)
Safety devices			High pressure switch, Outdoor fan driver overload protector, Inverter overload protector, Fusible plugs, Fuse	High pressure switch, Outdoor fan driver overload protector, Inverter overload protector, Fusible plugs, Fuse
Capacity Control		%	14-100	14-100
Refrigerant control			Electronic expansion valve	Electronic expansion valve
Ref. piping	Standard length	ft (m)	25 (7.6)	25 (7.6)
	Max. length	ft (m)	230 (70)	230 (70)
	Max. height difference	ft (m)	98 (30)	98 (30)
Refrigerant	Model		R-410A	R-410A
	Charge	lbs (kg)	7.9 (3.6)	7.9 (3.6)
Ref. oil	Model		DAPHNE FVC50K	DAPHNE FVC50K
	Charge	L	1.52	1.52
Drawing No.	Specification		C: 4D126357	C: 4D126357
	Sound (outdoor)		C: 4D101949D	C: 4D101949D
Notes:				
★1 Indoor temp. : 80°FDB (26.7°CDB), 67°FWB (19.4°CWB) / outdoor temp. : 95°FDB (35.0°CDB) / Equivalent piping length : 25 ft (7.6 m), level difference : 0 ft (0 m).				
★2 Capacities are net, including a deduction for cooling for indoor fan motor heat.				

Model name		Indoor unit	FHQ42MVJU
		Outdoor unit	RZR42TAVJUA
Power supply			1 phase, 208/230 V, 60 Hz
★1 ★2 Cooling capacity	Btu/h (kW)		40,500 (11.9)
SEER (Rated)			14.0
EER (Rated)	Btu/h-W		8.8
Indoor unit			FHQ42MVJU
Casing color			White (10Y9/0.5)
Dimensions: (H×W×D)		in (mm)	7-11/16 × 62-5/8 × 26-3/4 (195 × 1,590 × 680)
Coil	Type		Cross fin coil
	Rows×Stages×FPI		2 × 12 × 15 + 2 × 10 × 15
	Face area	ft ² (m ²)	3.66 (0.34) + 2.95 (0.27)
Fan	Model		—
	Type		Sirocco fan
	Motor output	W	130
	Airflow rate (H/L)	cfm (m ³ /min)	850/700 (24.1/19.8)
Air filter			Resin net (with mold resistance)
Weight		lbs (kg)	90 (19.8)
Connecting Pipes	Liquid Pipe	in (mm)	ϕ3/8 (ϕ9.5) (Flare connection)
	Gas Pipe	in (mm)	ϕ5/8 (ϕ15.9) (Flare connection)
	Drain Pipe	in (mm)	VP20 (External dia. 1 (26), internal dia. 3/4 (19.1))
Remote controller (option)	Wired		BRC1E73
	Wireless		BRC7E83
Outdoor unit			RZR42TAVJUA
Casing color			Ivory white
Dimensions: (H×W×D)		in (mm)	52-15/16 × 35-7/16 × 12-5/8 (1,345 × 900 × 320)
Coil	Type		Cross fin coil
	Rows×Stages×FPI		2 × 60 × 19
	Face area	ft ² (m ²)	12.2 (1.134)
Compressor	Model		2YC90FXD#A
	Type		Hermetically sealed swing type
	Motor output	kW	3.5
Fan	Model		P47N
	Type		Propeller fan
	Motor output	W	70 × 2
	Airflow rate	cfm (m ³ /min)	3,741 (106)
Weight		lbs (kg)	225 (102)
Sound pressure level		dB(A)	57
Connecting Pipes	Liquid Pipe	in (mm)	ϕ3/8 (ϕ9.5) (Flare connection)
	Gas Pipe	in (mm)	ϕ5/8 (ϕ15.9) (Flare connection)
	Drain Pipe	in (mm)	ϕ1 (ϕ26) (Hole)
Safety devices			High pressure switch, Outdoor fan driver overload protector, Inverter overload protector, Fusible plugs, Fuse
Capacity Control		%	14-100
Refrigerant control			Electronic expansion valve
Ref. piping	Standard length	ft (m)	25 (7.6)
	Max. length	ft (m)	230 (70)
	Max. height difference	ft (m)	98 (30)
Refrigerant	Model		R-410A
	Charge	lbs (kg)	7.9 (3.6)
Ref. oil	Model		DAPHNE FVC50K
	Charge	L	1.52
Drawing No.	Specification		C: 4D126357
	Sound (outdoor)		C: 4D101949D
Notes:			
★1 Indoor temp. : 80°FDB (26.7°CDB), 67°FWB (19.4°CWB) / outdoor temp. : 95°FDB (35.0°CDB) / Equivalent piping length : 25 ft (7.6 m), level difference : 0 ft (0 m).			
★2 Capacities are net, including a deduction for cooling for indoor fan motor heat.			

3.1.3 Wall Mounted Type

Model name	Indoor unit		FAQ18TAVJU	FAQ24TAVJU
	Outdoor unit		RZR18TAVJU	RZR24TAVJU
Power supply			1 phase, 208/230 V, 60 Hz	1 phase, 208/230 V, 60 Hz
★1 ★2 Cooling capacity	Btu/h (kW)		18,000 (5.3)	24,000 (7.0)
SEER (Rated)			17.0	17.6
EER (Rated)	Btu/h-W		11.9	10.2
Indoor unit			FAQ18TAVJU	FAQ24TAVJU
Casing color			White (3.0Y8.5/0.5)	White (3.0Y8.5/0.5)
Dimensions: (H×W×D)	in (mm)		11-3/8 × 41-3/8 × 9-1/4 (290 × 1,050 × 238)	11-3/8 × 41-3/8 × 9-1/4 (290 × 1,050 × 238)
Coil	Type		Cross fin coil	Cross fin coil
	Rows×Stages×FPI		2 × 14 × 7	2 × 14 × 7
	Face area	ft ² (m ²)	1.73 (0.16)	1.73 (0.16)
Fan	Model		QCL9686M	QCL9686M
	Type		Cross flow fan	Cross flow fan
	Motor output	W	43	43
	Airflow rate (H/L)	cfm (m ³ /min)	500/400 (14/11)	635/470 (18/13)
Sound pressure level (H/L)			43.0/37.0	47.0/41.0
Air filter			Resin net (washable)	Resin net (washable)
Weight	lbs (kg)		31 (14)	31 (14)
Connecting Pipes	Liquid Pipe	in (mm)	φ3/8 (φ9.5) (Flare connection)	φ3/8 (φ9.5) (Flare connection)
	Gas Pipe	in (mm)	φ5/8 (φ15.9) (Flare connection)	φ5/8 (φ15.9) (Flare connection)
	Drain Pipe	in (mm)	VP13 (External dia. 11/16 (18), internal dia. 1/2 (13))	VP13 (External dia. 11/16 (18), internal dia. 1/2 (13))
Remote controller (option)	Wired		BRC1E73, BRC2A71	BRC1E73, BRC2A71
	Wireless		BRC7E818	BRC7E818
Outdoor unit			RZR18TAVJU	RZR24TAVJU
Casing color			Ivory white	Ivory white
Dimensions: (H×W×D)	in (mm)		39 × 37 × 12-5/8 (990 × 940 × 320)	39 × 37 × 12-5/8 (990 × 940 × 320)
Coil	Type		Cross fin coil	Cross fin coil
	Rows×Stages×FPI		2 × 44 × 19	2 × 44 × 19
	Face area	ft ² (m ²)	9.5 (0.88)	9.5 (0.88)
Compressor	Model		2YC63ABXDD	2YC63ABXDD
	Type		Hermetically sealed swing type	Hermetically sealed swing type
	Motor output	kW	1.9	1.9
Fan	Model		P51J11F	P51J11F
	Type		Propeller fan	Propeller fan
	Motor output	W	200	200
	Airflow rate	cfm (m ³ /min)	2,682 (76)	2,682 (76)
Weight	lbs (kg)		172 (78)	172 (78)
Sound pressure level			58	58
Connecting Pipes	Liquid Pipe	in (mm)	φ3/8 (φ9.5) (Flare connection)	φ3/8 (φ9.5) (Flare connection)
	Gas Pipe	in (mm)	φ5/8 (φ15.9) (Flare connection)	φ5/8 (φ15.9) (Flare connection)
	Drain Pipe	in (mm)	φ1 (φ26) (Hole)	φ1 (φ26) (Hole)
Safety devices			High pressure switch, Outdoor fan driver overload protector, Inverter overload protector, Fusible plugs, Fuse	High pressure switch, Outdoor fan driver overload protector, Inverter overload protector, Fusible plugs, Fuse
Capacity Control	%		14-100	14-100
Refrigerant control			Electronic expansion valve	Electronic expansion valve
Ref. piping	Standard length	ft (m)	25 (7.6)	25 (7.6)
	Max. length	ft (m)	164 (50)	164 (50)
	Max. height difference	ft (m)	98 (30)	98 (30)
Refrigerant	Model		R-410A	R-410A
	Charge	lbs (kg)	6.4 (2.9)	6.4 (2.9)
Ref. oil	Model		DAPHNE FVC50K	DAPHNE FVC50K
	Charge	L	1.08	1.08
Drawing No.	Specification		C: 4D115552A	C: 4D115552A
	Sound (indoor)		C: 4D075583A	C: 4D075584A
	Sound (outdoor)		C: 4D101947D	C: 4D101947D
Notes:				
★1 Indoor temp. : 80°FDB (26.7°CDB), 67°FWB (19.4°CWB) / outdoor temp. : 95°FDB (35.0°CDB) / Equivalent piping length : 25 ft (7.6 m), level difference : 0 ft (0 m).				
★2 Capacities are net, including a deduction for cooling for indoor fan motor heat.				

Model name	Indoor unit		FAQ18TAVJU		FAQ24TAVJU	
	Outdoor unit		RZR18TAVJUA		RZR24TAVJUA	
Power supply			1 phase, 208/230 V, 60 Hz		1 phase, 208/230 V, 60 Hz	
★1 ★2 Cooling capacity	Btu/h (kW)		18,000 (5.3)		24,000 (7.0)	
SEER (Rated)			17.0		17.6	
EER (Rated)	Btu/h-W		11.9		10.2	
Indoor unit			FAQ18TAVJU		FAQ24TAVJU	
Casing color			White (3.0Y8.5/0.5)		White (3.0Y8.5/0.5)	
Dimensions: (H×W×D)	in (mm)		11-3/8 × 41-3/8 × 9-1/4 (290 × 1,050 × 238)		11-3/8 × 41-3/8 × 9-1/4 (290 × 1,050 × 238)	
Coil	Type		Cross fin coil		Cross fin coil	
	Rows×Stages×FPI		2 × 14 × 7		2 × 14 × 7	
	Face area	ft ² (m ²)	1.73 (0.16)		1.73 (0.16)	
Fan	Model		QCL9686M		QCL9686M	
	Type		Cross flow fan		Cross flow fan	
	Motor output	W	43		43	
Airflow rate (H/L)	cfm (m ³ /min)		500/400 (14/11)		635/470 (18/13)	
Sound pressure level (H/L)	dB(A)		43.0/37.0		47.0/41.0	
Air filter			Resin net (washable)		Resin net (washable)	
Weight	lbs (kg)		31 (14)		31 (14)	
Connecting Pipes	Liquid Pipe	in (mm)	φ3/8 (φ9.5) (Flare connection)		φ3/8 (φ9.5) (Flare connection)	
	Gas Pipe	in (mm)	φ5/8 (φ15.9) (Flare connection)		φ5/8 (φ15.9) (Flare connection)	
	Drain Pipe	in (mm)	VP13 (External dia. 11/16 (18), internal dia. 1/2 (13))		VP13 (External dia. 11/16 (18), internal dia. 1/2 (13))	
Remote controller (option)	Wired		BRC1E73, BRC2A71		BRC1E73, BRC2A71	
	Wireless		BRC7E818		BRC7E818	
Outdoor unit			RZR18TAVJUA		RZR24TAVJUA	
Casing color			Ivory white		Ivory white	
Dimensions: (H×W×D)	in (mm)		39 × 37 × 12-5/8 (990 × 940 × 320)		39 × 37 × 12-5/8 (990 × 940 × 320)	
Coil	Type		Cross fin coil		Cross fin coil	
	Rows×Stages×FPI		2 × 44 × 19		2 × 44 × 19	
	Face area	ft ² (m ²)	9.5 (0.88)		9.5 (0.88)	
Compressor	Model		2YC63TXD#A		2YC63TXD#A	
	Type		Hermetically sealed swing type		Hermetically sealed swing type	
	Motor output	kW	1.9		1.9	
Fan	Model		P51J11F		P51J11F	
	Type		Propeller fan		Propeller fan	
	Motor output	W	200		200	
Airflow rate	cfm (m ³ /min)		2,682 (76)		2,682 (76)	
Weight	lbs (kg)		172 (78)		172 (78)	
Sound pressure level	dB(A)		58		58	
Connecting Pipes	Liquid Pipe	in (mm)	φ3/8 (φ9.5) (Flare connection)		φ3/8 (φ9.5) (Flare connection)	
	Gas Pipe	in (mm)	φ5/8 (φ15.9) (Flare connection)		φ5/8 (φ15.9) (Flare connection)	
	Drain Pipe	in (mm)	φ1 (φ26) (Hole)		φ1 (φ26) (Hole)	
Safety devices			High pressure switch, Outdoor fan driver overload protector, Inverter overload protector, Fusible plugs, Fuse		High pressure switch, Outdoor fan driver overload protector, Inverter overload protector, Fusible plugs, Fuse	
Capacity Control	%		14-100		14-100	
Refrigerant control			Electronic expansion valve		Electronic expansion valve	
Ref. piping	Standard length	ft (m)	25 (7.6)		25 (7.6)	
	Max. length	ft (m)	164 (50)		164 (50)	
	Max. height difference	ft (m)	98 (30)		98 (30)	
Refrigerant	Model		R-410A		R-410A	
	Charge	lbs (kg)	6.4 (2.9)		6.4 (2.9)	
Ref. oil	Model		DAPHNE FVC50K		DAPHNE FVC50K	
	Charge	L	1.08		1.08	
Drawing No.	Specification		C: 4D126349		C: 4D126349	
	Sound (indoor)		C: 4D075583A		C: 4D075584A	
	Sound (outdoor)		C: 4D101947D		C: 4D101947D	

Notes:
 ★1 Indoor temp. : 80°FDB (26.7°CDB), 67°FWB (19.4°CWB) / outdoor temp. : 95°FDB (35.0°CDB) / Equivalent piping length : 25 ft (7.6 m), level difference : 0 ft (0 m).
 ★2 Capacities are net, including a deduction for cooling for indoor fan motor heat.

Model name		Indoor unit		FAQ18TAVJU		FAQ24TAVJU	
		Outdoor unit		RZR18TBVJUA		RZR24TBVJUA	
Power supply				1 phase, 208/230 V, 60 Hz		1 phase, 208/230 V, 60 Hz	
★1 ★2 Cooling capacity		Btu/h (kW)		18,000 (5.3)		24,000 (7.0)	
Indoor unit				FAQ18TAVJU		FAQ24TAVJU	
Casing color				White (3.0Y8.5/0.5)		White (3.0Y8.5/0.5)	
Dimensions: (H×W×D)		in (mm)		11-3/8 × 41-3/8 × 9-1/4 (290 × 1,050 × 238)		11-3/8 × 41-3/8 × 9-1/4 (290 × 1,050 × 238)	
Coil	Type			Cross fin coil		Cross fin coil	
Fan	Type			Cross flow fan		Cross flow fan	
	Motor output	W		43		43	
	Airflow rate (H/L)	cfm (m ³ /min)		500/400 (14/11)		635/470 (18/13)	
Sound pressure level (H/L)		dB(A)		43.0/37.0		47.0/41.0	
Air filter				Resin net (washable)		Resin net (washable)	
Weight		lbs (kg)		31 (14)		31 (14)	
Connecting Pipes	Liquid Pipe	in (mm)		φ3/8 (φ9.5) (Flare connection)		φ3/8 (φ9.5) (Flare connection)	
	Gas Pipe	in (mm)		φ5/8 (φ15.9) (Flare connection)		φ5/8 (φ15.9) (Flare connection)	
	Drain Pipe	in (mm)		VP13 (External dia. 11/16 (18), internal dia. 1/2 (13))		VP13 (External dia. 11/16 (18), internal dia. 1/2 (13))	
Remote controller (accessory)	Wired			BRC1E73, BRC1H71W		BRC1E73, BRC1H71W	
	Wireless			BRC7E818		BRC7E818	
Outdoor unit				RZR18TBVJUA		RZR24TBVJUA	
Casing color				Ivory white		Ivory white	
Dimensions: (H×W×D)		in (mm)		39 × 37 × 12-5/8 (990 × 940 × 320)		39 × 37 × 12-5/8 (990 × 940 × 320)	
Coil	Type			Cross fin coil		Cross fin coil	
Compressor	Type			Hermetically sealed swing type		Hermetically sealed swing type	
	Motor output	kW		1.9		1.9	
Fan	Type			Propeller fan		Propeller fan	
	Motor output	W		200		200	
	Airflow rate	cfm (m ³ /min)		2,682 (76)		2,682 (76)	
Weight		lbs (kg)		172 (78)		172 (78)	
Sound pressure level		dB(A)		58		58	
Connecting Pipes	Liquid Pipe	in (mm)		φ3/8 (φ9.5) (Flare connection)		φ3/8 (φ9.5) (Flare connection)	
	Gas Pipe	in (mm)		φ5/8 (φ15.9) (Flare connection)		φ5/8 (φ15.9) (Flare connection)	
	Drain Pipe	in (mm)		φ1 (φ26) (Hole)		φ1 (φ26) (Hole)	
Safety devices				High pressure switch, Outdoor fan driver overload protector, Inverter overload protector, Fusible plug, Fuse		High pressure switch, Outdoor fan driver overload protector, Inverter overload protector, Fusible plug, Fuse	
Capacity step		%		14-100		14-100	
Refrigerant control				Electronic expansion valve		Electronic expansion valve	
Ref. piping	Standard length	ft (m)		25 (7.6)		25 (7.6)	
	Max. length	ft (m)		164 (50)		164 (50)	
	Max. height difference	ft (m)		98 (30)		98 (30)	
Refrigerant	Type			R-410A		R-410A	
	Charge	lbs (kg)		6.4 (2.9)		6.4 (2.9)	
Ref. oil	Type			DAPHNE FVC50K		DAPHNE FVC50K	
	Charge	L		1.08		1.08	
Drawing No.	Specification			4D143006A		4D143006A	
	Sound (indoor)			4D075583A		4D075584A	
	Sound (outdoor)			4D101947D		4D101947D	
Notes:							
★1 Indoor temp. : 80°FDB (26.7°CDB), 67°FWB (19.4°CWB) / outdoor temp. : 95°FDB (35.0°CDB) / Equivalent piping length : 25 ft (7.6 m), height difference : 0 ft (0 m).							
★2 Capacities are net, including a deduction for cooling for indoor fan motor heat.							

3.1.4 HSP Ceiling Mounted Duct Type

Model name	Indoor unit		FBQ18PVJU		FBQ24PVJU	
	Outdoor unit		RZR18TAVJU		RZR24TAVJU	
Power supply			1 phase, 208/230 V, 60 Hz		1 phase, 208/230 V, 60 Hz	
★1 ★2 Cooling capacity	Btu/h (kW)		18,000 (5.3)		24,000 (7.0)	
SEER (Rated)			16.7		16.5	
EER (Rated)	Btu/h·W		13.0		12.0	
Indoor unit			FBQ18PVJU		FBQ24PVJU	
Casing color			Galvanized steel plate		Galvanized steel plate	
Dimensions: (H×W×D)			in (mm)		11-13/16 × 39-3/8 × 27-9/16 (300 × 1,000 × 700)	
Coil	Type		Cross fin coil		Cross fin coil	
	Rows×Stages×FPI		3 × 16 × 15		3 × 16 × 15	
	Face area	ft ² (m ²)	2.68 (0.249)		2.68 (0.249)	
Fan	Model		—		—	
	Type		Sirocco fan		Sirocco fan	
	Motor output	W	350		350	
	Airflow rate (H/M/L)	cfm (m ³ /min)	635/582/529 (18.0/16.5/15.0)		688/618/565 (19.5/17.5/16.0)	
	External static pressure	inH ₂ O (Pa)	Standard 0.40 <0.80-0.20> (100 <200-50>) ★3		Standard 0.40 <0.80-0.20> (100 <200-50>) ★3	
Sound pressure level (HH/H/L)		dB(A)	41.0/39.0/37.0		42.0/40.0/38.0	
Air filter			— ★4		— ★4	
Weight			lbs (kg)		80 (36)	
Connecting Pipes	Liquid Pipe	in (mm)	φ3/8 (φ9.5) (Flare connection)		φ3/8 (φ9.5) (Flare connection)	
	Gas Pipe	in (mm)	φ5/8 (φ15.9) (Flare connection)		φ5/8 (φ15.9) (Flare connection)	
	Drain Pipe	in (mm)	VP25 (External dia. 1-1/4 (32), internal dia. 1 (26))		VP25 (External dia. 1-1/4 (32), internal dia. 1 (26))	
	Remote controller (option)		Wired	BRC1E73, BRC2A71		BRC1E73, BRC2A71
		Wireless	BRC4C82, BRC082A43		BRC4C82, BRC082A43	
Outdoor unit			RZR18TAVJU		RZR24TAVJU	
Casing color			Ivory white		Ivory white	
Dimensions: (H×W×D)			in (mm)		39 × 37 × 12-5/8 (990 × 940 × 320)	
Coil	Type		Cross fin coil		Cross fin coil	
	Rows×Stages×FPI		2 × 44 × 19		2 × 44 × 19	
	Face area	ft ² (m ²)	9.5 (0.88)		9.5 (0.88)	
Compressor	Model		2YC63ABXDD		2YC63ABXDD	
	Type		Hermetically sealed swing type		Hermetically sealed swing type	
	Motor output	kW	1.9		1.9	
Fan	Model		P51J11F		P51J11F	
	Type		Propeller fan		Propeller fan	
	Motor output	W	200		200	
	Airflow rate	cfm (m ³ /min)	2,682 (76)		2,682 (76)	
Weight			lbs (kg)		172 (78)	
Sound pressure level			dB(A)		58	
Connecting Pipes	Liquid Pipe	in (mm)	φ3/8 (φ9.5) (Flare connection)		φ3/8 (φ9.5) (Flare connection)	
	Gas Pipe	in (mm)	φ5/8 (φ15.9) (Flare connection)		φ5/8 (φ15.9) (Flare connection)	
	Drain Pipe	in (mm)	φ1 (φ26) (Hole)		φ1 (φ26) (Hole)	
Safety devices			High pressure switch, Outdoor fan driver overload protector, Inverter overload protector, Fusible plugs, Fuse		High pressure switch, Outdoor fan driver overload protector, Inverter overload protector, Fusible plugs, Fuse	
Capacity Control			%		14-100	
Refrigerant control			Electronic expansion valve		Electronic expansion valve	
Ref. piping	Standard length	ft (m)	25 (7.6)		25 (7.6)	
	Max. length	ft (m)	164 (50)		164 (50)	
	Max. height difference	ft (m)	98 (30)		98 (30)	
Refrigerant	Model		R-410A		R-410A	
	Charge	lbs (kg)	6.4 (2.9)		6.4 (2.9)	
Ref. oil	Model		DAPHNE FVC50K		DAPHNE FVC50K	
	Charge	L	1.08		1.08	
Drawing No.	Specification		C: 4D115554		C: 4D115554	
	Sound (indoor)		C: 4D075278		C: 4D075279	
	Sound (outdoor)		C: 4D101947D		C: 4D101947D	

Notes:
★1 Indoor temp. : 80°FDB (26.7°CDB), 67°FWB (19.4°CWB) / outdoor temp. : 95°FDB (35.0°CDB) / Equivalent piping length : 25 ft (7.6 m), level difference : 0 ft (0 m).
★2 Capacities are net, including a deduction for cooling for indoor fan motor heat.
★3 External static pressure is changeable in 14 stages within the <> range by remote controller.
★4 Air filter is not standard accessory, but please mount it in the duct system of the suction side. Select its dust collection efficiency (gravity method) 50% or more.

Model name		Indoor unit	FBQ30PVJU	FBQ36PVJU
		Outdoor unit	RZR30TAVJU	RZR36TAVJU
Power supply			1 phase, 208/230 V, 60 Hz	1 phase, 208/230 V, 60 Hz
★1 ★2 Cooling capacity	Btu/h (kW)		30,000 (8.8)	36,000 (10.6)
SEER (Rated)			16.0	17.5
EER (Rated)	Btu/h-W		10.5	11.1
Indoor unit			FBQ30PVJU	FBQ36PVJU
Casing color			Galvanized steel plate	Galvanized steel plate
Dimensions: (H×W×D)		in (mm)	11-13/16 × 39-3/8 × 27-9/16 (300 × 1,000 × 700)	11-13/16 × 55-1/8 × 27-9/16 (300 × 1,400 × 700)
Coil	Type		Cross fin coil	Cross fin coil
	Rows×Stages×FPI		3 × 16 × 15	3 × 16 × 15
	Face area	ft ² (m ²)	2.68 (0.249)	4.12 (0.383)
Fan	Model		—	—
	Type		Sirocco fan	Sirocco fan
	Motor output	W	350	350
	Airflow rate (H/M/L)	cfm (m ³ /min)	882/794/706 (25.0/22.0/20.0)	1,130/953/812 (32.0/27.0/23.0)
	External static pressure	inH ₂ O (Pa)	Standard 0.40 <0.80-0.20> (100 <200-50>) ★3	Standard 0.40 <0.80-0.20> (100 <200-50>) ★3
Sound pressure level (HH/H/L)	dB(A)		43.0/41.0/39.0	43.0/41.0/39.0
Air filter			— ★4	— ★4
Weight	lbs (kg)		80 (36)	102 (46)
Connecting Pipes	Liquid Pipe	in (mm)	φ3/8 (φ9.5) (Flare connection)	φ3/8 (φ9.5) (Flare connection)
	Gas Pipe	in (mm)	φ5/8 (φ15.9) (Flare connection)	φ5/8 (φ15.9) (Flare connection)
	Drain Pipe	in (mm)	VP25 (External dia. 1-1/4 (32), internal dia. 1 (26))	VP25 (External dia. 1-1/4 (32), internal dia. 1 (26))
Remote controller (option)	Wired		BRC1E73, BRC2A71	BRC1E73, BRC2A71
	Wireless		BRC4C82, BRC082A43	BRC4C82, BRC082A43
Outdoor unit			RZR30TAVJU	RZR36TAVJU
Casing color			Ivory white	Ivory white
Dimensions: (H×W×D)		in (mm)	52-15/16 × 35-7/16 × 12-5/8 (1,345 × 900 × 320)	52-15/16 × 35-7/16 × 12-5/8 (1,345 × 900 × 320)
Coil	Type		Cross fin coil	Cross fin coil
	Rows×Stages×FPI		2 × 60 × 19	2 × 60 × 19
	Face area	ft ² (m ²)	12.2 (1.134)	12.2 (1.134)
Compressor	Model		2YC90GXD#D	2YC90GXD#D
	Type		Hermetically sealed swing type	Hermetically sealed swing type
	Motor output	kW	3.5	3.5
Fan	Model		P47N	P47N
	Type		Propeller fan	Propeller fan
	Motor output	W	70 × 2	70 × 2
	Airflow rate	cfm (m ³ /min)	3,741 (106)	3,741 (106)
Weight	lbs (kg)		225 (102)	225 (102)
Sound pressure level		dB(A)	57	57
Connecting Pipes	Liquid Pipe	in (mm)	φ3/8 (φ9.5) (Flare connection)	φ3/8 (φ9.5) (Flare connection)
	Gas Pipe	in (mm)	φ5/8 (φ15.9) (Flare connection)	φ5/8 (φ15.9) (Flare connection)
	Drain Pipe	in (mm)	φ1 (φ26) (Hole)	φ1 (φ26) (Hole)
Safety devices			High pressure switch, Outdoor fan driver overload protector, Inverter overload protector, Fusible plugs, Fuse	High pressure switch, Outdoor fan driver overload protector, Inverter overload protector, Fusible plugs, Fuse
Capacity Control		%	14-100	14-100
Refrigerant control			Electronic expansion valve	Electronic expansion valve
Ref. piping	Standard length	ft (m)	25 (7.6)	25 (7.6)
	Max. length	ft (m)	230 (70)	230 (70)
	Max. height difference	ft (m)	98 (30)	98 (30)
Refrigerant	Model		R-410A	R-410A
	Charge	lbs (kg)	7.9 (3.6)	7.9 (3.6)
Ref. oil	Model		DAPHNE FVC50K	DAPHNE FVC50K
	Charge	L	1.52	1.52
Drawing No.	Specification		C: 4D115556A	C: 4D115556A
	Sound (indoor)		C: 4D075280	C: 4D075281
	Sound (outdoor)		C: 4D101949D	C: 4D101949D

Notes:

★1 Indoor temp. : 80°FDB (26.7°CDB), 67°FWB (19.4°CWB) / outdoor temp. : 95°FDB (35.0°CDB) / Equivalent piping length : 25 ft (7.6 m), level difference : 0 ft (0 m).

★2 Capacities are net, including a deduction for cooling for indoor fan motor heat.

★3 External static pressure is changeable in 14 stages within the < > range by remote controller.

★4 Air filter is not standard accessory, but please mount it in the duct system of the suction side. Select its dust collection efficiency (gravity method) 50% or more.

Model name	Indoor unit		FBQ42PVJU	FBQ48PVJU
	Outdoor unit		RZR42TAVJU	RZR48TAVJU
Power supply			1 phase, 208/230 V, 60 Hz	1 phase, 208/230 V, 60 Hz
★1 ★2 Cooling capacity	Btu/h (kW)		40,500 (11.9)	48,000 (14.1)
SEER (Rated)			16.0	14.0
EER (Rated)	Btu/h-W		10.1	8.6
Indoor unit			FBQ42PVJU	FBQ48PVJU
Casing color			Galvanized steel plate	Galvanized steel plate
Dimensions: (H×W×D)			in (mm) 11-13/16 × 55-1/8 × 27-9/16 (300 × 1,400 × 700)	11-13/16 × 55-1/8 × 27-9/16 (300 × 1,400 × 700)
Coil	Type		Cross fin coil	Cross fin coil
	Rows×Stages×FPI		3 × 16 × 15	3 × 16 × 15
	Face area	ft ² (m ²)	4.12 (0.383)	4.12 (0.383)
Fan	Model		—	—
	Type		Sirocco fan	Sirocco fan
	Motor output	W	350	350
	Airflow rate (H/M/L)	cfm (m ³ /min)	1,400/1,165/988 (39.6/33.0/28.0)	1,400/1,165/988 (39.6/33.0/28.0)
	External static pressure	inH ₂ O (Pa)	Standard 0.40 <0.80-0.20> (100 <200-50>) ★3	Standard 0.40 <0.80-0.20> (100 <200-50>) ★3
Sound pressure level (HH/H/L)	dB(A)	44.0/42.0/40.0	44.0/42.0/40.0	
Air filter			— ★4	— ★4
Weight	lbs (kg)		102 (46)	102 (46)
Connecting Pipes	Liquid Pipe	in (mm)	φ3/8 (φ9.5) (Flare connection)	φ3/8 (φ9.5) (Flare connection)
	Gas Pipe	in (mm)	φ5/8 (φ15.9) (Flare connection)	φ5/8 (φ15.9) (Flare connection)
	Drain Pipe	in (mm)	VP25 (External dia. 1-1/4 (32), internal dia. 1 (26))	VP25 (External dia. 1-1/4 (32), internal dia. 1 (26))
Remote controller (option)	Wired		BRC1E73, BRC2A71	BRC1E73, BRC2A71
	Wireless		BRC4C82, BRC082A43	BRC4C82, BRC082A43
Outdoor unit			RZR42TAVJU	RZR48TAVJU
Casing color			Ivory white	Ivory white
Dimensions: (H×W×D)			in (mm) 52-15/16 × 35-7/16 × 12-5/8 (1,345 × 900 × 320)	52-15/16 × 35-7/16 × 12-5/8 (1,345 × 900 × 320)
Coil	Type		Cross fin coil	Cross fin coil
	Rows×Stages×FPI		2 × 60 × 19	2 × 60 × 19
	Face area	ft ² (m ²)	12.2 (1.134)	12.2 (1.134)
Compressor	Model		2YC90GXD#D	2YC90GXD#D
	Type		Hermetically sealed swing type	Hermetically sealed swing type
	Motor output	kW	3.5	3.5
Fan	Model		P47N	P47N
	Type		Propeller fan	Propeller fan
	Motor output	W	70 × 2	70 × 2
	Airflow rate	cfm (m ³ /min)	3,741 (106)	3,741 (106)
Weight	lbs (kg)		225 (102)	225 (102)
Sound pressure level			57	57
Connecting Pipes	Liquid Pipe	in (mm)	φ3/8 (φ9.5) (Flare connection)	φ3/8 (φ9.5) (Flare connection)
	Gas Pipe	in (mm)	φ5/8 (φ15.9) (Flare connection)	φ5/8 (φ15.9) (Flare connection)
	Drain Pipe	in (mm)	φ1 (φ26) (Hole)	φ1 (φ26) (Hole)
Safety devices			High pressure switch, Outdoor fan driver overload protector, Inverter overload protector, Fusible plugs, Fuse	High pressure switch, Outdoor fan driver overload protector, Inverter overload protector, Fusible plugs, Fuse
Capacity Control			% 14-100	14-100
Refrigerant control			Electronic expansion valve	Electronic expansion valve
Ref. piping	Standard length	ft (m)	25 (7.6)	25 (7.6)
	Max. length	ft (m)	230 (70)	230 (70)
	Max. height difference	ft (m)	98 (30)	98 (30)
Refrigerant	Model		R-410A	R-410A
	Charge	lbs (kg)	7.9 (3.6)	7.9 (3.6)
Ref. oil	Model		DAPHNE FVC50K	DAPHNE FVC50K
	Charge	L	1.52	1.52
Drawing No.	Specification		C: 4D115556A	C: 4D115556A
	Sound (indoor)		C: 4D075282A	C: 4D075282A
	Sound (outdoor)		C: 4D101949D	C: 4D101949D

Notes:

- ★1 Indoor temp. : 80°FDB (26.7°CDB), 67°FWB (19.4°CWB) / outdoor temp. : 95°FDB (35.0°CDB) / Equivalent piping length : 25 ft (7.6 m), level difference : 0 ft (0 m).
- ★2 Capacities are net, including a deduction for cooling for indoor fan motor heat.
- ★3 External static pressure is changeable in 14 stages within the < > range by remote controller.
- ★4 Air filter is not standard accessory, but please mount it in the duct system of the suction side. Select its dust collection efficiency (gravity method) 50% or more.

Model name		Indoor unit		FBQ18PVJU		FBQ24PVJU	
		Outdoor unit		RZR18TAVJUA		RZR24TAVJUA	
Power supply				1 phase, 208/230 V, 60 Hz		1 phase, 208/230 V, 60 Hz	
★1 ★2 Cooling capacity		Btu/h (kW)	18,000 (5.3)		24,000 (7.0)		
SEER (Rated)				16.7		16.5	
EER (Rated)		Btu/h-W	13.0		12.0		
Indoor unit		FBQ18PVJU		FBQ24PVJU			
Casing color				Galvanized steel plate		Galvanized steel plate	
Dimensions: (H×W×D)		in (mm)	11-13/16 × 39-3/8 × 27-9/16 (300 × 1,000 × 700)		11-13/16 × 39-3/8 × 27-9/16 (300 × 1,000 × 700)		
Coil	Type	Cross fin coil		Cross fin coil			
	Rows×Stages×FPI	3 × 16 × 15		3 × 16 × 15			
	Face area	ft ² (m ²)	2.68 (0.249)		2.68 (0.249)		
Fan	Model	—		—			
	Type	Sirocco fan		Sirocco fan			
	Motor output	W	350		350		
	Airflow rate (H/M/L)	cfm (m ³ /min)	635/582/529 (18.0/16.5/15.0)		688/618/565 (19.5/17.5/16.0)		
	External static pressure	inH ₂ O (Pa)	Standard 0.40 <0.80-0.20> (100 <200-50>) ★3		Standard 0.40 <0.80-0.20> (100 <200-50>) ★3		
Sound pressure level (HH/H/L)		dB(A)	41.0/39.0/37.0		42.0/40.0/38.0		
Air filter				— ★4		— ★4	
Weight		lbs (kg)	80 (36)		80 (36)		
Connecting Pipes	Liquid Pipe	in (mm)	φ3/8 (φ9.5) (Flare connection)		φ3/8 (φ9.5) (Flare connection)		
	Gas Pipe	in (mm)	φ5/8 (φ15.9) (Flare connection)		φ5/8 (φ15.9) (Flare connection)		
	Drain Pipe	in (mm)	VP25 (External dia. 1-1/4 (32), internal dia. 1 (26))		VP25 (External dia. 1-1/4 (32), internal dia. 1 (26))		
Remote controller (option)	Wired	BRC1E73, BRC2A71		BRC1E73, BRC2A71			
	Wireless	BRC4C82, BRC082A43		BRC4C82, BRC082A43			
Outdoor unit		RZR18TAVJUA		RZR24TAVJUA			
Casing color				Ivory white		Ivory white	
Dimensions: (H×W×D)		in (mm)	39 × 37 × 12-5/8 (990 × 940 × 320)		39 × 37 × 12-5/8 (990 × 940 × 320)		
Coil	Type	Cross fin coil		Cross fin coil			
	Rows×Stages×FPI	2 × 44 × 19		2 × 44 × 19			
	Face area	ft ² (m ²)	9.5 (0.88)		9.5 (0.88)		
Compressor	Model	2YC63TXD#A		2YC63TXD#A			
	Type	Hermetically sealed swing type		Hermetically sealed swing type			
	Motor output	kW	1.9		1.9		
Fan	Model	P51J11F		P51J11F			
	Type	Propeller fan		Propeller fan			
	Motor output	W	200		200		
	Airflow rate	cfm (m ³ /min)	2,682 (76)		2,682 (76)		
Weight		lbs (kg)	172 (78)		172 (78)		
Sound pressure level		dB(A)	58		58		
Connecting Pipes	Liquid Pipe	in (mm)	φ3/8 (φ9.5) (Flare connection)		φ3/8 (φ9.5) (Flare connection)		
	Gas Pipe	in (mm)	φ5/8 (φ15.9) (Flare connection)		φ5/8 (φ15.9) (Flare connection)		
	Drain Pipe	in (mm)	φ1 (φ26) (Hole)		φ1 (φ26) (Hole)		
Safety devices				High pressure switch, Outdoor fan driver overload protector, Inverter overload protector, Fusible plugs, Fuse		High pressure switch, Outdoor fan driver overload protector, Inverter overload protector, Fusible plugs, Fuse	
Capacity Control		%	14-100		14-100		
Refrigerant control				Electronic expansion valve		Electronic expansion valve	
Ref. piping	Standard length	ft (m)	25 (7.6)		25 (7.6)		
	Max. length	ft (m)	164 (50)		164 (50)		
	Max. height difference	ft (m)	98 (30)		98 (30)		
Refrigerant	Model	R-410A		R-410A			
	Charge	lbs (kg)	6.4 (2.9)		6.4 (2.9)		
Ref. oil	Model	DAPHNE FVC50K		DAPHNE FVC50K			
	Charge	L	1.08		1.08		
Drawing No.	Specification	C: 4D126351		C: 4D126351			
	Sound (indoor)	C: 4D075278		C: 4D075279			
	Sound (outdoor)	C: 4D101947D		C: 4D101947D			

Notes:

★1 Indoor temp. : 80°FDB (26.7°CDB), 67°FWB (19.4°CWB) / outdoor temp. : 95°FDB (35.0°CDB) / Equivalent piping length : 25 ft (7.6 m), level difference : 0 ft (0 m).

★2 Capacities are net, including a deduction for cooling for indoor fan motor heat.

★3 External static pressure is changeable in 14 stages within the < > range by remote controller.

★4 Air filter is not standard accessory, but please mount it in the duct system of the suction side. Select its dust collection efficiency (gravity method) 50% or more.

Model name	Indoor unit		FBQ30PVJU	FBQ36PVJU
	Outdoor unit		RZR30TAVJUA	RZR36TAVJUA
Power supply			1 phase, 208/230 V, 60 Hz	1 phase, 208/230 V, 60 Hz
★1 ★2 Cooling capacity	Btu/h (kW)		30,000 (8.8)	36,000 (10.6)
SEER (Rated)			16.0	17.5
EER (Rated)	Btu/h-W		10.5	11.1
Indoor unit			FBQ30PVJU	FBQ36PVJU
Casing color			Galvanized steel plate	Galvanized steel plate
Dimensions: (H×W×D)			in (mm) 11-13/16 × 39-3/8 × 27-9/16 (300 × 1,000 × 700)	11-13/16 × 55-1/8 × 27-9/16 (300 × 1,400 × 700)
Coil	Type		Cross fin coil	Cross fin coil
	Rows×Stages×FPI		3 × 16 × 15	3 × 16 × 15
	Face area	ft ² (m ²)	2.68 (0.249)	4.12 (0.383)
Fan	Model		—	—
	Type		Sirocco fan	Sirocco fan
	Motor output	W	350	350
	Airflow rate (H/M/L)	cfm (m ³ /min)	882/794/706 (25.0/22.0/20.0)	1,130/953/812 (32.0/27.0/23.0)
	External static pressure	inH ₂ O (Pa)	Standard 0.40 <0.80-0.20> (100 <200-50>) ★3	Standard 0.40 <0.80-0.20> (100 <200-50>) ★3
Sound pressure level (HH/H/L)	dB(A)	43.0/41.0/39.0	43.0/41.0/39.0	
Air filter			— ★4	— ★4
Weight	lbs (kg)		80 (36)	102 (46)
Connecting Pipes	Liquid Pipe	in (mm)	φ3/8 (φ9.5) (Flare connection)	φ3/8 (φ9.5) (Flare connection)
	Gas Pipe	in (mm)	φ5/8 (φ15.9) (Flare connection)	φ5/8 (φ15.9) (Flare connection)
	Drain Pipe	in (mm)	VP25 (External dia. 1-1/4 (32), internal dia. 1 (26))	VP25 (External dia. 1-1/4 (32), internal dia. 1 (26))
Remote controller (option)	Wired		BRC1E73, BRC2A71	BRC1E73, BRC2A71
	Wireless		BRC4C82, BRC082A43	BRC4C82, BRC082A43
Outdoor unit			RZR30TAVJUA	RZR36TAVJUA
Casing color			Ivory white	Ivory white
Dimensions: (H×W×D)			in (mm) 52-15/16 × 35-7/16 × 12-5/8 (1,345 × 900 × 320)	52-15/16 × 35-7/16 × 12-5/8 (1,345 × 900 × 320)
Coil	Type		Cross fin coil	Cross fin coil
	Rows×Stages×FPI		2 × 60 × 19	2 × 60 × 19
	Face area	ft ² (m ²)	12.2 (1.134)	12.2 (1.134)
Compressor	Model		2YC90FXD#A	2YC90FXD#A
	Type		Hermetically sealed swing type	Hermetically sealed swing type
	Motor output	kW	3.5	3.5
Fan	Model		P47N	P47N
	Type		Propeller fan	Propeller fan
	Motor output	W	70 × 2	70 × 2
	Airflow rate	cfm (m ³ /min)	3,741 (106)	3,741 (106)
Weight	lbs (kg)		225 (102)	225 (102)
Sound pressure level			57	57
Connecting Pipes	Liquid Pipe	in (mm)	φ3/8 (φ9.5) (Flare connection)	φ3/8 (φ9.5) (Flare connection)
	Gas Pipe	in (mm)	φ5/8 (φ15.9) (Flare connection)	φ5/8 (φ15.9) (Flare connection)
	Drain Pipe	in (mm)	φ1 (φ26) (Hole)	φ1 (φ26) (Hole)
Safety devices			High pressure switch, Outdoor fan driver overload protector, Inverter overload protector, Fusible plugs, Fuse	High pressure switch, Outdoor fan driver overload protector, Inverter overload protector, Fusible plugs, Fuse
Capacity Control			14-100	14-100
Refrigerant control			Electronic expansion valve	Electronic expansion valve
Ref. piping	Standard length	ft (m)	25 (7.6)	25 (7.6)
	Max. length	ft (m)	230 (70)	230 (70)
	Max. height difference	ft (m)	98 (30)	98 (30)
Refrigerant	Model		R-410A	R-410A
	Charge	lbs (kg)	7.9 (3.6)	7.9 (3.6)
Ref. oil	Model		DAPHNE FVC50K	DAPHNE FVC50K
	Charge	L	1.52	1.52
Drawing No.	Specification		C: 4D126353	C: 4D126353
	Sound (indoor)		C: 4D075280	C: 4D075281
	Sound (outdoor)		C: 4D101949D	C: 4D101949D

Notes:

- ★1 Indoor temp. : 80°FDB (26.7°CDB), 67°FWB (19.4°CWB) / outdoor temp. : 95°FDB (35.0°CDB) / Equivalent piping length : 25 ft (7.6 m), level difference : 0 ft (0 m).
- ★2 Capacities are net, including a deduction for cooling for indoor fan motor heat.
- ★3 External static pressure is changeable in 14 stages within the < > range by remote controller.
- ★4 Air filter is not standard accessory, but please mount it in the duct system of the suction side. Select its dust collection efficiency (gravity method) 50% or more.

Model name		Indoor unit	FBQ42PVJU	FBQ48PVJU
		Outdoor unit	RZR42TAVJUA	RZR48TAVJUA
Power supply			1 phase, 208/230 V, 60 Hz	1 phase, 208/230 V, 60 Hz
★1 ★2 Cooling capacity	Btu/h (kW)		40,500 (11.9)	48,000 (14.1)
SEER (Rated)			16.0	14.0
EER (Rated)	Btu/h-W		10.1	8.6
Indoor unit			FBQ42PVJU	FBQ48PVJU
Casing color			Galvanized steel plate	Galvanized steel plate
Dimensions: (H×W×D)		in (mm)	11-13/16 × 55-1/8 × 27-9/16 (300 × 1,400 × 700)	11-13/16 × 55-1/8 × 27-9/16 (300 × 1,400 × 700)
Coil	Type		Cross fin coil	Cross fin coil
	Rows×Stages×FPI		3 × 16 × 15	3 × 16 × 15
	Face area	ft ² (m ²)	4.12 (0.383)	4.12 (0.383)
Fan	Model		—	—
	Type		Sirocco fan	Sirocco fan
	Motor output	W	350	350
	Airflow rate (H/M/L)	cfm (m ³ /min)	1,400/1,165/988 (39.6/33.0/28.0)	1,400/1,165/988 (39.6/33.0/28.0)
	External static pressure	inH ₂ O (Pa)	Standard 0.40 <0.80-0.20> (100 <200-50>) ★3	Standard 0.40 <0.80-0.20> (100 <200-50>) ★3
Sound pressure level (HH/H/L)	dB(A)		44.0/42.0/40.0	44.0/42.0/40.0
Air filter			— ★4	— ★4
Weight		lbs (kg)	102 (46)	102 (46)
Connecting Pipes	Liquid Pipe	in (mm)	φ3/8 (φ9.5) (Flare connection)	φ3/8 (φ9.5) (Flare connection)
	Gas Pipe	in (mm)	φ5/8 (φ15.9) (Flare connection)	φ5/8 (φ15.9) (Flare connection)
	Drain Pipe	in (mm)	VP25 (External dia. 1-1/4 (32), internal dia. 1 (26))	VP25 (External dia. 1-1/4 (32), internal dia. 1 (26))
Remote controller (option)	Wired		BRC1E73, BRC2A71	BRC1E73, BRC2A71
	Wireless		BRC4C82, BRC082A43	BRC4C82, BRC082A43
Outdoor unit			RZR42TAVJUA	RZR48TAVJUA
Casing color			Ivory white	Ivory white
Dimensions: (H×W×D)		in (mm)	52-15/16 × 35-7/16 × 12-5/8 (1,345 × 900 × 320)	52-15/16 × 35-7/16 × 12-5/8 (1,345 × 900 × 320)
Coil	Type		Cross fin coil	Cross fin coil
	Rows×Stages×FPI		2 × 60 × 19	2 × 60 × 19
	Face area	ft ² (m ²)	12.2 (1.134)	12.2 (1.134)
Compressor	Model		2YC90FXD#A	2YC90FXD#A
	Type		Hermetically sealed swing type	Hermetically sealed swing type
	Motor output	kW	3.5	3.5
Fan	Model		P47N	P47N
	Type		Propeller fan	Propeller fan
	Motor output	W	70 × 2	70 × 2
	Airflow rate	cfm (m ³ /min)	3,741 (106)	3,741 (106)
Weight		lbs (kg)	225 (102)	225 (102)
Sound pressure level		dB(A)	57	57
Connecting Pipes	Liquid Pipe	in (mm)	φ3/8 (φ9.5) (Flare connection)	φ3/8 (φ9.5) (Flare connection)
	Gas Pipe	in (mm)	φ5/8 (φ15.9) (Flare connection)	φ5/8 (φ15.9) (Flare connection)
	Drain Pipe	in (mm)	φ1 (φ26) (Hole)	φ1 (φ26) (Hole)
Safety devices			High pressure switch, Outdoor fan driver overload protector, Inverter overload protector, Fusible plugs, Fuse	High pressure switch, Outdoor fan driver overload protector, Inverter overload protector, Fusible plugs, Fuse
Capacity Control		%	14-100	14-100
Refrigerant control			Electronic expansion valve	Electronic expansion valve
Ref. piping	Standard length	ft (m)	25 (7.6)	25 (7.6)
	Max. length	ft (m)	230 (70)	230 (70)
	Max. height difference	ft (m)	98 (30)	98 (30)
Refrigerant	Model		R-410A	R-410A
	Charge	lbs (kg)	7.9 (3.6)	7.9 (3.6)
Ref. oil	Model		DAPHNE FVC50K	DAPHNE FVC50K
	Charge	L	1.52	1.52
Drawing No.	Specification		C: 4D126353	C: 4D126353
	Sound (indoor)		C: 4D075282A	C: 4D075282A
	Sound (outdoor)		C: 4D101949D	C: 4D101949D

Notes:

★1 Indoor temp. : 80°FDB (26.7°CDB), 67°FWB (19.4°CWB) / outdoor temp. : 95°FDB (35.0°CDB) / Equivalent piping length : 25 ft (7.6 m), level difference : 0 ft (0 m).

★2 Capacities are net, including a deduction for cooling for indoor fan motor heat.

★3 External static pressure is changeable in 14 stages within the < > range by remote controller.

★4 Air filter is not standard accessory, but please mount it in the duct system of the suction side. Select its dust collection efficiency (gravity method) 50% or more.

Model name		Indoor unit	FBQ18TBVJU	FBQ24TBVJU
		Outdoor unit	RZR18TBVJUA	RZR24TBVJUA
Power supply			1 phase, 208/230 V, 60 Hz	1 phase, 208/230 V, 60 Hz
★1 ★2 Cooling capacity	Btu/h (kW)		17,700 (5.2)	23,400 (6.9)
Indoor unit			FBQ18TBVJU	FBQ24TBVJU
Casing color			Galvanized steel plate	Galvanized steel plate
Dimensions: (H×W×D)		in (mm)	9-11/16 × 39-3/8 × 31-1/2 (245 × 1,000 × 800)	9-11/16 × 39-3/8 × 31-1/2 (245 × 1,000 × 800)
Coil	Type		Cross fin coil	Cross fin coil
Fan	Type		Sirocco fan	Sirocco fan
	Motor output	W	230	230
	Airflow rate (H/M/L)	cfm (m³/min)	635/565/512 (18.0/16.0/14.5)	742/635/565 (21.0/18.0/16.0)
	External static pressure	inH ₂ O (Pa)	Standard 0.40 <0.80-0.20> (100 <200-50>) ★3	Standard 0.40 <0.80-0.20> (100 <200-50>) ★3
Sound pressure level (H/M/L)		dB(A)	38.0/35.0/32.0	39.0/35.0/33.0
Air filter			— ★4	— ★4
Weight		lbs (kg)	77 (35)	82 (37)
Connecting Pipes	Liquid Pipe	in (mm)	φ3/8 (φ9.5) (Flare connection)	φ3/8 (φ9.5) (Flare connection)
	Gas Pipe	in (mm)	φ5/8 (φ15.9) (Flare connection)	φ5/8 (φ15.9) (Flare connection)
	Drain Pipe	in (mm)	VP25 (External dia. 1-1/4 (32), internal dia. 1 (26))	VP25 (External dia. 1-1/4 (32), internal dia. 1 (26))
Remote controller (accessory)	Wired		BRC1E73, BRC1H71W	BRC1E73, BRC1H71W
	Wireless		BRC082A43	BRC082A43
Outdoor unit			RZR18TBVJUA	RZR24TBVJUA
Casing color			Ivory white	Ivory white
Dimensions: (H×W×D)		in (mm)	39 × 37 × 12-5/8 (990 × 940 × 320)	39 × 37 × 12-5/8 (990 × 940 × 320)
Coil	Type		Cross fin coil	Cross fin coil
Compressor	Type		Hermetically sealed swing type	Hermetically sealed swing type
	Motor output	kW	1.9	1.9
Fan	Type		Propeller fan	Propeller fan
	Motor output	W	200	200
	Airflow rate	cfm (m³/min)	2,682 (76)	2,682 (76)
Weight		lbs (kg)	172 (78)	172 (78)
Sound pressure level		dB(A)	58	58
Connecting Pipes	Liquid Pipe	in (mm)	φ3/8 (φ9.5) (Flare connection)	φ3/8 (φ9.5) (Flare connection)
	Gas Pipe	in (mm)	φ5/8 (φ15.9) (Flare connection)	φ5/8 (φ15.9) (Flare connection)
	Drain Pipe	in (mm)	φ1 (φ26) (Hole)	φ1 (φ26) (Hole)
Safety devices			High pressure switch, Outdoor fan driver overload protector, Inverter overload protector, Fusible plug, Fuse	High pressure switch, Outdoor fan driver overload protector, Inverter overload protector, Fusible plug, Fuse
Capacity step		%	14-100	14-100
Refrigerant control			Electronic expansion valve	Electronic expansion valve
Ref. piping	Standard length	ft (m)	25 (7.6)	25 (7.6)
	Max. length	ft (m)	164 (50)	164 (50)
	Max. height difference	ft (m)	98 (30)	98 (30)
Refrigerant	Type		R-410A	R-410A
	Charge	lbs (kg)	6.4 (2.9)	6.4 (2.9)
Ref. oil	Type		DAPHNE FVC50K	DAPHNE FVC50K
	Charge	L	1.08	1.08
Drawing No.	Specification		4D143009A	4D143009A
	Sound (indoor)		4D143354	4D143355
	Sound (outdoor)		4D101947D	4D101947D

Notes:

- ★1 Indoor temp. : 80°FDB (26.7°CDB), 67°FWB (19.4°CWB) / outdoor temp. : 95°FDB (35.0°CDB) / Equivalent piping length : 25 ft (7.6 m), height difference : 0 ft (0 m).
- ★2 Capacities are net, including a deduction for cooling for indoor fan motor heat.
- ★3 External static pressure is changeable in 14 stages within the < > range by remote controller.
- ★4 Air filter is not standard accessory, but please mount it in the duct system of the suction side. Select its dust collection efficiency (gravity method) 50% or more.

Model name		Indoor unit	FBQ30TBVJU	FBQ36TBVJU
		Outdoor unit	RZR30TBVJUA	RZR36TBVJUA
Power supply			1 phase, 208/230 V, 60 Hz	1 phase, 208/230 V, 60 Hz
★1 ★2 Cooling capacity	Btu/h (kW)		28,400 (8.3)	35,000 (10.3)
Indoor unit			FBQ30TBVJU	FBQ36TBVJU
Casing color			Galvanized steel plate	Galvanized steel plate
Dimensions: (H×W×D)		in (mm)	9-11/16 × 55-1/8 × 31-1/2 (245 × 1,400 × 800)	9-11/16 × 55-1/8 × 31-1/2 (245 × 1,400 × 800)
Coil	Type		Cross fin coil	Cross fin coil
Fan	Type		Sirocco fan	Sirocco fan
	Motor output	W	364	364
	Airflow rate (H/M/L)	cfm (m ³ /min)	1,094/847/795 (31.0/24.0/22.5)	1,130/953/795 (32.0/27.0/22.5)
	External static pressure	inH ₂ O (Pa)	Standard 0.40 <0.80-0.20> (100 <200-50>) ★3	Standard 0.40 <0.80-0.20> (100 <200-50>) ★3
Sound pressure level (H/M/L)		dB(A)	43.0/38.0/36.0	44.0/40.0/36.0
Air filter			— ★4	— ★4
Weight		lbs (kg)	101 (46)	101 (46)
Connecting Pipes	Liquid Pipe	in (mm)	φ3/8 (φ9.5) (Flare connection)	φ3/8 (φ9.5) (Flare connection)
	Gas Pipe	in (mm)	φ5/8 (φ15.9) (Flare connection)	φ5/8 (φ15.9) (Flare connection)
	Drain Pipe	in (mm)	VP25 (External dia. 1-1/4 (32), internal dia. 1 (26))	VP25 (External dia. 1-1/4 (32), internal dia. 1 (26))
Remote controller (accessory)	Wired		BRC1E73, BRC1H71W	BRC1E73, BRC1H71W
	Wireless		BR082A43	BR082A43
Outdoor unit			RZR30TBVJUA	RZR36TBVJUA
Casing color			Ivory white	Ivory white
Dimensions: (H×W×D)		in (mm)	52-15/16 × 35-7/16 × 12-5/8 (1,345 × 900 × 320)	52-15/16 × 35-7/16 × 12-5/8 (1,345 × 900 × 320)
Coil	Type		Cross fin coil	Cross fin coil
Compressor	Type		Hermetically sealed swing type	Hermetically sealed swing type
	Motor output	kW	3.5	3.5
Fan	Type		Propeller fan	Propeller fan
	Motor output	W	70 × 2	70 × 2
	Airflow rate	cfm (m ³ /min)	3,741 (106)	3,741 (106)
Weight		lbs (kg)	225 (102)	225 (102)
Sound pressure level		dB(A)	57	57
Connecting Pipes	Liquid Pipe	in (mm)	φ3/8 (φ9.5) (Flare connection)	φ3/8 (φ9.5) (Flare connection)
	Gas Pipe	in (mm)	φ5/8 (φ15.9) (Flare connection)	φ5/8 (φ15.9) (Flare connection)
	Drain Pipe	in (mm)	φ1 (φ26) (Hole)	φ1 (φ26) (Hole)
Safety devices			High pressure switch, Outdoor fan driver overload protector, Inverter overload protector, Fusible plug, Fuse	High pressure switch, Outdoor fan driver overload protector, Inverter overload protector, Fusible plug, Fuse
Capacity step		%	14-100	14-100
Refrigerant control			Electronic expansion valve	Electronic expansion valve
Ref. piping	Standard length	ft (m)	25 (7.6)	25 (7.6)
	Max. length	ft (m)	230 (70)	230 (70)
	Max. height difference	ft (m)	98 (30)	98 (30)
Refrigerant	Type		R-410A	R-410A
	Charge	lbs (kg)	7.9 (3.6)	7.9 (3.6)
Ref. oil	Type		DAPHNE FVC50K	DAPHNE FVC50K
	Charge	L	1.52	1.52
Drawing No.	Specification		4D143010A	4D143010A
	Sound (indoor)		4D143356	4D143357
	Sound (outdoor)		4D101949D	4D101949D

Notes:

★1 Indoor temp. : 80°FDB (26.7°CDB), 67°FWB (19.4°CWB) / outdoor temp. : 95°FDB (35.0°CDB) / Equivalent piping length : 25 ft (7.6 m), height difference : 0 ft (0 m).

★2 Capacities are net, including a deduction for cooling for indoor fan motor heat.

★3 External static pressure is changeable in 14 stages within the <> range by remote controller.

★4 Air filter is not standard accessory, but please mount it in the duct system of the suction side. Select its dust collection efficiency (gravity method) 50% or more.

Model name		Indoor unit	FBQ42TBVJU	FBQ48TBVJU
		Outdoor unit	RZR42TBVJUA	RZR48TBVJUA
Power supply			1 phase, 208/230 V, 60 Hz	1 phase, 208/230 V, 60 Hz
★1 ★2 Cooling capacity	Btu/h (kW)		40,000 (11.7)	46,500 (13.6)
Indoor unit			FBQ42TBVJU	FBQ48TBVJU
Casing color			Galvanized steel plate	Galvanized steel plate
Dimensions: (H×W×D)		in (mm)	9-11/16 × 55-1/8 × 31-1/2 (245 × 1,400 × 800)	9-11/16 × 55-1/8 × 31-1/2 (245 × 1,400 × 800)
Coil	Type		Cross fin coil	Cross fin coil
Fan	Type		Sirocco fan	Sirocco fan
	Motor output	W	364	364
	Airflow rate (H/M/L)	cfm (m³/min)	1,377/1,130/918 (39.0/32.0/26.0)	1,377/1,130/918 (39.0/32.0/26.0)
	External static pressure	inH ₂ O (Pa)	Standard 0.40 <0.80-0.20> (100 <200-50>) ★3	Standard 0.40 <0.80-0.20> (100 <200-50>) ★3
Sound pressure level (H/M/L)		dB(A)	48.0/44.0/39.0	48.0/44.0/39.0
Air filter			— ★4	— ★4
Weight		lbs (kg)	104 (47)	104 (47)
Connecting Pipes	Liquid Pipe	in (mm)	φ3/8 (φ9.5) (Flare connection)	φ3/8 (φ9.5) (Flare connection)
	Gas Pipe	in (mm)	φ5/8 (φ15.9) (Flare connection)	φ5/8 (φ15.9) (Flare connection)
	Drain Pipe	in (mm)	VP25 (External dia. 1-1/4 (32), internal dia. 1 (26))	VP25 (External dia. 1-1/4 (32), internal dia. 1 (26))
Remote controller (accessory)	Wired		BRC1E73, BRC1H71W	BRC1E73, BRC1H71W
	Wireless		BR082A43	BR082A43
Outdoor unit			RZR42TBVJUA	RZR48TBVJUA
Casing color			Ivory white	Ivory white
Dimensions: (H×W×D)		in (mm)	52-15/16 × 35-7/16 × 12-5/8 (1,345 × 900 × 320)	52-15/16 × 35-7/16 × 12-5/8 (1,345 × 900 × 320)
Coil	Type		Cross fin coil	Cross fin coil
Compressor	Type		Hermetically sealed swing type	Hermetically sealed swing type
	Motor output	kW	3.5	3.5
Fan	Type		Propeller fan	Propeller fan
	Motor output	W	70 × 2	70 × 2
	Airflow rate	cfm (m³/min)	3,741 (106)	3,741 (106)
Weight		lbs (kg)	225 (102)	225 (102)
Sound pressure level		dB(A)	57	57
Connecting Pipes	Liquid Pipe	in (mm)	φ3/8 (φ9.5) (Flare connection)	φ3/8 (φ9.5) (Flare connection)
	Gas Pipe	in (mm)	φ5/8 (φ15.9) (Flare connection)	φ5/8 (φ15.9) (Flare connection)
	Drain Pipe	in (mm)	φ1 (φ26) (Hole)	φ1 (φ26) (Hole)
Safety devices			High pressure switch, Outdoor fan driver overload protector, Inverter overload protector, Fusible plug, Fuse	High pressure switch, Outdoor fan driver overload protector, Inverter overload protector, Fusible plug, Fuse
Capacity step		%	14-100	14-100
Refrigerant control			Electronic expansion valve	Electronic expansion valve
Ref. piping	Standard length	ft (m)	25 (7.6)	25 (7.6)
	Max. length	ft (m)	230 (70)	230 (70)
	Max. height difference	ft (m)	98 (30)	98 (30)
Refrigerant	Type		R-410A	R-410A
	Charge	lbs (kg)	7.9 (3.6)	7.9 (3.6)
Ref. oil	Type		DAPHNE FVC50K	DAPHNE FVC50K
	Charge	L	1.52	1.52
Drawing No.	Specification		4D143010A	4D143010A
	Sound (indoor)		4D143359	4D143360
	Sound (outdoor)		4D101949D	4D101949D

Notes:

★1 Indoor temp. : 80°FDB (26.7°CDB), 67°FWB (19.4°CWB) / outdoor temp. : 95°FDB (35.0°CDB) / Equivalent piping length : 25 ft (7.6 m), height difference : 0 ft (0 m).

★2 Capacities are net, including a deduction for cooling for indoor fan motor heat.

★3 External static pressure is changeable in 14 stages within the <> range by remote controller.

★4 Air filter is not standard accessory, but please mount it in the duct system of the suction side. Select its dust collection efficiency (gravity method) 50% or more.

3.1.5 Multi Position Air Handling Unit

Model name	Indoor unit		FTQ18TAVJUD, FTQ18TAVJUA		FTQ24TAVJUD, FTQ24TAVJUA	
	Outdoor unit		RZR18TAVJU		RZR24TAVJU	
Power supply			1 phase, 208/230 V, 60 Hz		1 phase, 208/230 V, 60 Hz	
★1 ★2 Cooling capacity	Btu/h (kW)		18,000 (5.3)		24,000 (7.0)	
SEER (Rated)			15.5		15.2	
EER (Rated)	Btu/h-W		12.5		10.3	
Indoor unit			FTQ18TAVJUD, FTQ18TAVJUA		FTQ24TAVJUD, FTQ24TAVJUA	
Casing color			Daikin Slate Gray		Daikin Slate Gray	
Dimensions: (H×W×D)		in (mm)	45 × 17.5 × 21 (1,143 × 445 × 533)		45 × 17.5 × 21 (1,143 × 445 × 533)	
Coil	Type		Cross fin coil		Cross fin coil	
	Face area	ft ² (m ²)	3.75 (35)		3.75 (35)	
Fan	Type		Sirocco FC Centrifugal		Sirocco FC Centrifugal	
	Motor output	HP	1/2		1/2	
	Airflow rate (H/M/L)	cfm (m ³ /min)	600/510/420 (17.0/14.4/11.9)		800/680/560 (22.7/19.3/15.9)	
	External static pressure	in. w.g.	0.1" - 0.9"		0.1" - 0.9"	
Sound pressure level (H/M/L)	dB(A)		44.6/41.3/38.4		51.6/48.2/44.0	
Air filter			— ★3		— ★3	
Weight		lbs (kg)	115 (52.2)		115 (52.2)	
Connecting Pipes	Liquid Pipe	in (mm)	φ3/8 (φ9.5) (Brazing connection)		φ3/8 (φ9.5) (Brazing connection)	
	Gas Pipe	in (mm)	φ5/8 (φ15.9) (Brazing connection)		φ5/8 (φ15.9) (Brazing connection)	
	Drain Pipe	in (mm)	3/4" (19.1)		3/4" (19.1)	
Remote controller (option)	Wired		BRC1E73, BRC2A71		BRC1E73, BRC2A71	
	Wireless		BRC4C82		BRC4C82	
Outdoor unit			RZR18TAVJU		RZR24TAVJU	
Casing color			Ivory white		Ivory white	
Dimensions: (H×W×D)		in (mm)	39 × 37 × 12-5/8 (990 × 940 × 320)		39 × 37 × 12-5/8 (990 × 940 × 320)	
Coil	Type		Cross fin coil		Cross fin coil	
	Rows×Stages×FPI		2 × 44 × 19		2 × 44 × 19	
	Face area	ft ² (m ²)	9.5 (0.88)		9.5 (0.88)	
Compressor	Model		2YC63ABXDD		2YC63ABXDD	
	Type		Hermetically sealed swing type		Hermetically sealed swing type	
	Motor output	kW	1.9		1.9	
Fan	Model		P51J11F		P51J11F	
	Type		Propeller fan		Propeller fan	
	Motor output	W	200		200	
	Airflow rate	cfm (m ³ /min)	2,682 (76)		2,682 (76)	
Weight		lbs (kg)	172 (78)		172 (78)	
Sound pressure level		dB(A)	58		58	
Connecting Pipes	Liquid Pipe	in (mm)	φ3/8 (φ9.5) (Flare connection)		φ3/8 (φ9.5) (Flare connection)	
	Gas Pipe	in (mm)	φ5/8 (φ15.9) (Flare connection)		φ5/8 (φ15.9) (Flare connection)	
	Drain Pipe	in (mm)	φ1 (φ26) (Hole)		φ1 (φ26) (Hole)	
Safety devices			High pressure switch, Outdoor fan driver overload protector, Inverter overload protector, Fusible plugs, Fuse		High pressure switch, Outdoor fan driver overload protector, Inverter overload protector, Fusible plugs, Fuse	
Capacity Control		%	14-100		14-100	
Refrigerant control			Electronic expansion valve		Electronic expansion valve	
Ref. piping	Standard length	ft (m)	25 (7.6)		25 (7.6)	
	Max. length	ft (m)	164 (50)		164 (50)	
	Max. height difference	ft (m)	98 (30)		98 (30)	
Refrigerant	Model		R-410A		R-410A	
	Charge	lbs (kg)	6.4 (2.9)		6.4 (2.9)	
Ref. oil	Model		DAPHNE FVC50K		DAPHNE FVC50K	
	Charge	L	1.08		1.08	
Drawing No.	Sound (outdoor)		C: 4D101947D		C: 4D101947D	

Notes:

★1 Indoor temp. : 80°FDB (26.7°CDB), 67°FWB (19.4°CWB) / Outdoor temp. : 95°FDB (35.0°CDB) / Equivalent piping length : 25 ft (7.6 m), level difference : 0 ft (0 m).

★2 Capacities are net, including a deduction for cooling (an addition for heating) for indoor fan motor heat.

★3 Air filter is not standard accessory (field supply parts), but please mount it in the duct system of the suction side.

Model name	Indoor unit		FTQ30TAVJUD, FTQ30TAVJUA		FTQ36TAVJUD, FTQ36TAVJUA	
	Outdoor unit		RZR30TAVJU		RZR36TAVJU	
Power supply			1 phase, 208/230 V, 60 Hz		1 phase, 208/230 V, 60 Hz	
★1 ★2 Cooling capacity		Btu/h (kW)	30,000 (8.8)		36,000 (10.6)	
SEER (Rated)			16.0		15.3	
EER (Rated)		Btu/h-W	12.5		11.3	
Indoor unit			FTQ30TAVJUD, FTQ30TAVJUA		FTQ36TAVJUD, FTQ36TAVJUA	
Casing color			Daikin Slate Gray		Daikin Slate Gray	
Dimensions: (H×W×D)		in (mm)	45 × 17.5 × 21 (1,143 × 445 × 533)		45 × 17.5 × 21 (1,143 × 445 × 533)	
Coil	Type		Cross fin coil		Cross fin coil	
	Face area	ft ² (m ²)	3.75 (35)		3.75 (35)	
Fan	Type		Sirocco FC Centrifugal		Sirocco FC Centrifugal	
	Motor output	HP	1/2		1/2	
	Airflow rate (H/M/L)	cfm (m ³ /min)	1,000/850/700 (28.3/24.1/19.8)		1,050/900/750 (29.7/25.5/21.2)	
	External static pressure	in. w.g.	0.1" - 0.9"		0.1" - 0.9"	
Sound pressure level (H/M/L)		dB(A)	51.6/48.2/44.0		51.6/48.2/44.0	
Air filter			— ★3		— ★3	
Weight		lbs (kg)	115 (52.2)		140 (63.5)	
Connecting Pipes	Liquid Pipe	in (mm)	φ3/8 (φ9.5) (Brazing connection)		φ3/8 (φ9.5) (Brazing connection)	
	Gas Pipe	in (mm)	φ5/8 (φ15.9) (Brazing connection)		φ5/8 (φ15.9) (Brazing connection)	
	Drain Pipe	in (mm)	3/4" (19.1)		3/4" (19.1)	
Remote controller (option)	Wired		BRC1E73, BRC2A71		BRC1E73, BRC2A71	
	Wireless		BRC4C82		BRC4C82	
Outdoor unit			RZR30TAVJU		RZR36TAVJU	
Casing color			Ivory white		Ivory white	
Dimensions: (H×W×D)		in (mm)	52-15/16 × 35-7/16 × 12-5/8 (1,345 × 900 × 320)		52-15/16 × 35-7/16 × 12-5/8 (1,345 × 900 × 320)	
Coil	Type		Cross fin coil		Cross fin coil	
	Rows×Stages×FPI		2 × 60 × 19		2 × 60 × 19	
	Face area	ft ² (m ²)	12.2 (1.134)		12.2 (1.134)	
Compressor	Model		2YC90GXD#D		2YC90GXD#D	
	Type		Hermetically sealed swing type		Hermetically sealed swing type	
	Motor output	kW	3.5		3.5	
Fan	Model		P47N		P47N	
	Type		Propeller fan		Propeller fan	
	Motor output	W	70 × 2		70 × 2	
	Airflow rate	cfm (m ³ /min)	3,741 (106)		3,741 (106)	
Weight		lbs (kg)	225 (102)		225 (102)	
Sound pressure level		dB(A)	57		57	
Connecting Pipes	Liquid Pipe	in (mm)	φ3/8 (φ9.5) (Flare connection)		φ3/8 (φ9.5) (Flare connection)	
	Gas Pipe	in (mm)	φ5/8 (φ15.9) (Flare connection)		φ5/8 (φ15.9) (Flare connection)	
	Drain Pipe	in (mm)	φ1 (φ26) (Hole)		φ1 (φ26) (Hole)	
Safety devices			High pressure switch, Outdoor fan driver overload protector, Inverter overload protector, Fusible plugs, Fuse		High pressure switch, Outdoor fan driver overload protector, Inverter overload protector, Fusible plugs, Fuse	
Capacity Control		%	14-100		14-100	
Refrigerant control			Electronic expansion valve		Electronic expansion valve	
Ref. piping	Standard length	ft (m)	25 (7.6)		25 (7.6)	
	Max. length	ft (m)	230 (70)		230 (70)	
	Max. height difference	ft (m)	98 (30)		98 (30)	
Refrigerant	Model		R-410A		R-410A	
	Charge	lbs (kg)	7.9 (3.6)		7.9 (3.6)	
Ref. oil	Model		DAPHNE FVC50K		DAPHNE FVC50K	
	Charge	L	1.52		1.52	
Drawing No.	Sound (outdoor)		C: 4D101949D		C: 4D101949D	

Notes:
 ★1 Indoor temp. : 80°FDB (26.7°CDB), 67°FWB (19.4°CWB) / Outdoor temp. : 95°FDB (35.0°CDB) / Equivalent piping length : 25 ft (7.6 m), level difference : 0 ft (0 m).
 ★2 Capacities are net, including a deduction for cooling (an addition for heating) for indoor fan motor heat.
 ★3 Air filter is not standard accessory (field supply parts), but please mount it in the duct system of the suction side.

Model name	Indoor unit		FTQ42TAVJUD, FTQ42TAVJUA		FTQ48TAVJUD, FTQ48TAVJUA	
	Outdoor unit		RZR42TAVJU		RZR48TAVJU	
Power supply			1 phase, 208/230 V, 60 Hz		1 phase, 208/230 V, 60 Hz	
★1 ★2 Cooling capacity		Btu/h (kW)	42,000 (12.3)		48,000 (14.1)	
SEER (Rated)			16.0		14.8	
EER (Rated)		Btu/h-W	11.0		9.5	
Indoor unit			FTQ42TAVJUD, FTQ42TAVJUA		FTQ48TAVJUD, FTQ48TAVJUA	
Casing color			Daikin Slate Gray		Daikin Slate Gray	
Dimensions: (H×W×D)		in (mm)	53.43 × 21 × 21 (1,357 × 533 × 533)		53.43 × 21 × 21 (1,357 × 533 × 533)	
Coil	Type		Cross fin coil		Cross fin coil	
	Face area	ft ² (m ²)	5.15 (48)		5.15 (48)	
Fan	Type		Sirocco FC Centrifugal		Sirocco FC Centrifugal	
	Motor output	HP	3/4		3/4	
	Airflow rate (H/M/L)	cfm (m ³ /min)	1,400/1,190/980 (39.7/33.7/27.8)		1,520/1,290/1,060 (43.1/36.5/30.0)	
	External static pressure	in. w.g.	0.1" - 0.9"		0.1" - 0.9"	
Sound pressure level (H/M/L)		dB(A)	53.8/50.0/45.6		53.8/50.0/45.6	
Air filter			— ★3		— ★3	
Weight		lbs (kg)	150 (68)		150 (68)	
Connecting Pipes	Liquid Pipe	in (mm)	φ3/8 (φ9.5) (Brazing connection)		φ3/8 (φ9.5) (Brazing connection)	
	Gas Pipe	in (mm)	φ5/8 (φ15.9) (Brazing connection)		φ5/8 (φ15.9) (Brazing connection)	
	Drain Pipe	in (mm)	3/4" (19.1)		3/4" (19.1)	
Remote controller (option)	Wired		BRC1E73, BRC2A71		BRC1E73, BRC2A71	
	Wireless		BRC4C82		BRC4C82	
Outdoor unit			RZR42TAVJU		RZR48TAVJU	
Casing color			Ivory white		Ivory white	
Dimensions: (H×W×D)		in (mm)	52-15/16 × 35-7/16 × 12-5/8 (1,345 × 900 × 320)		52-15/16 × 35-7/16 × 12-5/8 (1,345 × 900 × 320)	
Coil	Type		Cross fin coil		Cross fin coil	
	Rows×Stages×FPI		2 × 60 × 19		2 × 60 × 19	
	Face area	ft ² (m ²)	12.2 (1.134)		12.2 (1.134)	
Compressor	Model		2YC90GXD#D		2YC90GXD#D	
	Type		Hermetically sealed swing type		Hermetically sealed swing type	
	Motor output	kW	3.5		3.5	
Fan	Model		P47N		P47N	
	Type		Propeller fan		Propeller fan	
	Motor output	W	70 × 2		70 × 2	
	Airflow rate	cfm (m ³ /min)	3,741 (106)		3,741 (106)	
Weight		lbs (kg)	225 (102)		225 (102)	
Sound pressure level		dB(A)	57		57	
Connecting Pipes	Liquid Pipe	in (mm)	φ3/8 (φ9.5) (Flare connection)		φ3/8 (φ9.5) (Flare connection)	
	Gas Pipe	in (mm)	φ5/8 (φ15.9) (Flare connection)		φ5/8 (φ15.9) (Flare connection)	
	Drain Pipe	in (mm)	φ1 (φ26) (Hole)		φ1 (φ26) (Hole)	
Safety devices			High pressure switch, Outdoor fan driver overload protector, Inverter overload protector, Fusible plugs, Fuse		High pressure switch, Outdoor fan driver overload protector, Inverter overload protector, Fusible plugs, Fuse	
Capacity Control		%	14-100		14-100	
Refrigerant control			Electronic expansion valve		Electronic expansion valve	
Ref. piping	Standard length	ft (m)	25 (7.6)		25 (7.6)	
	Max. length	ft (m)	230 (70)		230 (70)	
	Max. height difference	ft (m)	98 (30)		98 (30)	
Refrigerant	Model		R-410A		R-410A	
	Charge	lbs (kg)	7.9 (3.6)		7.9 (3.6)	
Ref. oil	Model		DAPHNE FVC50K		DAPHNE FVC50K	
	Charge	L	1.52		1.52	
Drawing No.	Sound (outdoor)		C: 4D101949D		C: 4D101949D	

Notes:

★1 Indoor temp. : 80°FDB (26.7°CDB), 67°FWB (19.4°CWB) / Outdoor temp. : 95°FDB (35.0°CDB) / Equivalent piping length : 25 ft (7.6 m), level difference : 0 ft (0 m).

★2 Capacities are net, including a deduction for cooling (an addition for heating) for indoor fan motor heat.

★3 Air filter is not standard accessory (field supply parts), but please mount it in the duct system of the suction side.

Model name	Indoor unit		FTQ18TAVJUD, FTQ18TAVJUA		FTQ24TAVJUD, FTQ24TAVJUA	
	Outdoor unit		RZR18TAVJUA		RZR24TAVJUA	
Power supply			1 phase, 208/230 V, 60 Hz		1 phase, 208/230 V, 60 Hz	
★1 ★2 Cooling capacity	Btu/h (kW)		18,000 (5.3)		24,000 (7.0)	
SEER (Rated)			15.5		15.2	
EER (Rated)	Btu/h-W		12.5		10.3	
Indoor unit			FTQ18TAVJUD, FTQ18TAVJUA		FTQ24TAVJUD, FTQ24TAVJUA	
Casing color			Daikin Slate Gray		Daikin Slate Gray	
Dimensions: (H×W×D)	in (mm)		45 × 17.5 × 21 (1,143 × 445 × 533)		45 × 17.5 × 21 (1,143 × 445 × 533)	
Coil	Type		Cross fin coil		Cross fin coil	
	Face area	ft ² (m ²)	3.75 (35)		3.75 (35)	
Fan	Type		Sirocco FC Centrifugal		Sirocco FC Centrifugal	
	Motor output	HP	1/2		1/2	
	Airflow rate (H/M/L)	cfm (m ³ /min)	600/510/420 (17.0/14.4/11.9)		800/680/560 (22.7/19.3/15.9)	
	External static pressure	in. w.g.	0.1" - 0.9"		0.1" - 0.9"	
Sound pressure level (H/M/L)	dB(A)		44.6/41.3/38.4		51.6/48.2/44.0	
Air filter			— ★3		— ★3	
Weight	lbs (kg)		115 (52.2)		115 (52.2)	
Connecting Pipes	Liquid Pipe	in (mm)	φ3/8 (φ9.5) (Brazing connection)		φ3/8 (φ9.5) (Brazing connection)	
	Gas Pipe	in (mm)	φ5/8 (φ15.9) (Brazing connection)		φ5/8 (φ15.9) (Brazing connection)	
	Drain Pipe	in (mm)	3/4" (19.1)		3/4" (19.1)	
Remote controller (option)	Wired		BRC1E73, BRC2A71		BRC1E73, BRC2A71	
	Wireless		BRC4C82		BRC4C82	
Outdoor unit			RZR18TAVJUA		RZR24TAVJUA	
Casing color			Ivory white		Ivory white	
Dimensions: (H×W×D)	in (mm)		39 × 37 × 12-5/8 (990 × 940 × 320)		39 × 37 × 12-5/8 (990 × 940 × 320)	
Coil	Type		Cross fin coil		Cross fin coil	
	Rows×Stages×FPI		2 × 44 × 19		2 × 44 × 19	
	Face area	ft ² (m ²)	9.5 (0.88)		9.5 (0.88)	
Compressor	Model		2YC63TXD#A		2YC63TXD#A	
	Type		Hermetically sealed swing type		Hermetically sealed swing type	
	Motor output	kW	1.9		1.9	
Fan	Model		P51J11F		P51J11F	
	Type		Propeller fan		Propeller fan	
	Motor output	W	200		200	
	Airflow rate	cfm (m ³ /min)	2,682 (76)		2,682 (76)	
Weight	lbs (kg)		172 (78)		172 (78)	
Sound pressure level	dB(A)		58		58	
Connecting Pipes	Liquid Pipe	in (mm)	φ3/8 (φ9.5) (Flare connection)		φ3/8 (φ9.5) (Flare connection)	
	Gas Pipe	in (mm)	φ5/8 (φ15.9) (Flare connection)		φ5/8 (φ15.9) (Flare connection)	
	Drain Pipe	in (mm)	φ1 (φ26) (Hole)		φ1 (φ26) (Hole)	
Safety devices			High pressure switch, Outdoor fan driver overload protector, Inverter overload protector, Fusible plugs, Fuse		High pressure switch, Outdoor fan driver overload protector, Inverter overload protector, Fusible plugs, Fuse	
Capacity Control	%		14-100		14-100	
Refrigerant control			Electronic expansion valve		Electronic expansion valve	
Ref. piping	Standard length	ft (m)	25 (7.6)		25 (7.6)	
	Max. length	ft (m)	164 (50)		164 (50)	
	Max. height difference	ft (m)	98 (30)		98 (30)	
Refrigerant	Model		R-410A		R-410A	
	Charge	lbs (kg)	6.4 (2.9)		6.4 (2.9)	
Ref. oil	Model		DAPHNE FVC50K		DAPHNE FVC50K	
	Charge	L	1.08		1.08	
Drawing No.	Sound (outdoor)		C: 4D101947D		C: 4D101947D	

Notes:
 ★1 Indoor temp. : 80°FDB (26.7°CDB), 67°FWB (19.4°CWB) / Outdoor temp. : 95°FDB (35.0°CDB) / Equivalent piping length : 25 ft (7.6 m), level difference : 0 ft (0 m).
 ★2 Capacities are net, including a deduction for cooling (an addition for heating) for indoor fan motor heat.
 ★3 Air filter is not standard accessory (field supply parts), but please mount it in the duct system of the suction side.

Model name	Indoor unit		FTQ30TAVJUD, FTQ30TAVJUA		FTQ36TAVJUD, FTQ36TAVJUA	
	Outdoor unit		RZR30TAVJUA		RZR36TAVJUA	
Power supply			1 phase, 208/230 V, 60 Hz		1 phase, 208/230 V, 60 Hz	
★1 ★2 Cooling capacity		Btu/h (kW)	30,000 (8.8)		36,000 (10.6)	
SEER (Rated)			16.0		15.3	
EER (Rated)		Btu/h-W	12.5		11.3	
Indoor unit			FTQ30TAVJUD, FTQ30TAVJUA		FTQ36TAVJUD, FTQ36TAVJUA	
Casing color			Daikin Slate Gray		Daikin Slate Gray	
Dimensions: (H×W×D)		in (mm)	45 × 17.5 × 21 (1,143 × 445 × 533)		45 × 17.5 × 21 (1,143 × 445 × 533)	
Coil	Type		Cross fin coil		Cross fin coil	
	Face area	ft ² (m ²)	3.75 (35)		3.75 (35)	
Fan	Type		Sirocco FC Centrifugal		Sirocco FC Centrifugal	
	Motor output	HP	1/2		1/2	
	Airflow rate (H/M/L)	cfm (m ³ /min)	1,000/850/700 (28.3/24.1/19.8)		1,050/900/750 (29.7/25.5/21.2)	
	External static pressure	in. w.g.	0.1" - 0.9"		0.1" - 0.9"	
Sound pressure level (H/M/L)		dB(A)	51.6/48.2/44.0		51.6/48.2/44.0	
Air filter			— ★3		— ★3	
Weight		lbs (kg)	115 (52.2)		140 (63.5)	
Connecting Pipes	Liquid Pipe	in (mm)	φ3/8 (φ9.5) (Brazing connection)		φ3/8 (φ9.5) (Brazing connection)	
	Gas Pipe	in (mm)	φ5/8 (φ15.9) (Brazing connection)		φ5/8 (φ15.9) (Brazing connection)	
	Drain Pipe	in (mm)	3/4" (19.1)		3/4" (19.1)	
Remote controller (option)	Wired		BRC1E73, BRC2A71		BRC1E73, BRC2A71	
	Wireless		BRC4C82		BRC4C82	
Outdoor unit			RZR30TAVJUA		RZR36TAVJUA	
Casing color			Ivory white		Ivory white	
Dimensions: (H×W×D)		in (mm)	52-15/16 × 35-7/16 × 12-5/8 (1,345 × 900 × 320)		52-15/16 × 35-7/16 × 12-5/8 (1,345 × 900 × 320)	
Coil	Type		Cross fin coil		Cross fin coil	
	Rows×Stages×FPI		2 × 60 × 19		2 × 60 × 19	
	Face area	ft ² (m ²)	12.2 (1.134)		12.2 (1.134)	
Compressor	Model		2YC90FXD#A		2YC90FXD#A	
	Type		Hermetically sealed swing type		Hermetically sealed swing type	
	Motor output	kW	3.5		3.5	
Fan	Model		P47N		P47N	
	Type		Propeller fan		Propeller fan	
	Motor output	W	70 × 2		70 × 2	
	Airflow rate	cfm (m ³ /min)	3,741 (106)		3,741 (106)	
Weight		lbs (kg)	225 (102)		225 (102)	
Sound pressure level		dB(A)	57		57	
Connecting Pipes	Liquid Pipe	in (mm)	φ3/8 (φ9.5) (Flare connection)		φ3/8 (φ9.5) (Flare connection)	
	Gas Pipe	in (mm)	φ5/8 (φ15.9) (Flare connection)		φ5/8 (φ15.9) (Flare connection)	
	Drain Pipe	in (mm)	φ1 (φ26) (Hole)		φ1 (φ26) (Hole)	
Safety devices			High pressure switch, Outdoor fan driver overload protector, Inverter overload protector, Fusible plugs, Fuse		High pressure switch, Outdoor fan driver overload protector, Inverter overload protector, Fusible plugs, Fuse	
Capacity Control		%	14-100		14-100	
Refrigerant control			Electronic expansion valve		Electronic expansion valve	
Ref. piping	Standard length	ft (m)	25 (7.6)		25 (7.6)	
	Max. length	ft (m)	230 (70)		230 (70)	
	Max. height difference	ft (m)	98 (30)		98 (30)	
Refrigerant	Model		R-410A		R-410A	
	Charge	lbs (kg)	7.9 (3.6)		7.9 (3.6)	
Ref. oil	Model		DAPHNE FVC50K		DAPHNE FVC50K	
	Charge	L	1.52		1.52	
Drawing No.	Sound (outdoor)		C: 4D101949D		C: 4D101949D	

Notes:

★1 Indoor temp. : 80°FDB (26.7°CDB), 67°FWB (19.4°CWB) / Outdoor temp. : 95°FDB (35.0°CDB) / Equivalent piping length : 25 ft (7.6 m), level difference : 0 ft (0 m).

★2 Capacities are net, including a deduction for cooling (an addition for heating) for indoor fan motor heat.

★3 Air filter is not standard accessory (field supply parts), but please mount it in the duct system of the suction side.

Model name	Indoor unit		FTQ42TAVJUD, FTQ42TAVJUA		FTQ48TAVJUD, FTQ48TAVJUA	
	Outdoor unit		RZR42TAVJUA		RZR48TAVJUA	
Power supply			1 phase, 208/230 V, 60 Hz		1 phase, 208/230 V, 60 Hz	
★1 ★2 Cooling capacity		Btu/h (kW)	42,000 (12.3)		48,000 (14.1)	
SEER (Rated)			16.0		14.8	
EER (Rated)		Btu/h-W	11.0		9.5	
Indoor unit			FTQ42TAVJUD, FTQ42TAVJUA		FTQ48TAVJUD, FTQ48TAVJUA	
Casing color			Daikin Slate Gray		Daikin Slate Gray	
Dimensions: (H×W×D)		in (mm)	53.43 × 21 × 21 (1,357 × 533 × 533)		53.43 × 21 × 21 (1,357 × 533 × 533)	
Coil	Type		Cross fin coil		Cross fin coil	
	Face area	ft ² (m ²)	5.15 (48)		5.15 (48)	
Fan	Type		Sirocco FC Centrifugal		Sirocco FC Centrifugal	
	Motor output	HP	3/4		3/4	
	Airflow rate (H/M/L)	cfm (m ³ /min)	1,400/1,190/980 (39.7/33.7/27.8)		1,520/1,290/1,060 (43.1/36.5/30.0)	
	External static pressure	in. w.g.	0.1" - 0.9"		0.1" - 0.9"	
Sound pressure level (H/M/L)		dB(A)	53.8/50.0/45.6		53.8/50.0/45.6	
Air filter			— ★3		— ★3	
Weight		lbs (kg)	150 (68)		150 (68)	
Connecting Pipes	Liquid Pipe	in (mm)	φ3/8 (φ9.5) (Brazing connection)		φ3/8 (φ9.5) (Brazing connection)	
	Gas Pipe	in (mm)	φ5/8 (φ15.9) (Brazing connection)		φ5/8 (φ15.9) (Brazing connection)	
	Drain Pipe	in (mm)	3/4" (19.1)		3/4" (19.1)	
Remote controller (option)	Wired		BRC1E73, BRC2A71		BRC1E73, BRC2A71	
	Wireless		BRC4C82		BRC4C82	
Outdoor unit			RZR42TAVJUA		RZR48TAVJUA	
Casing color			Ivory white		Ivory white	
Dimensions: (H×W×D)		in (mm)	52-15/16 × 35-7/16 × 12-5/8 (1,345 × 900 × 320)		52-15/16 × 35-7/16 × 12-5/8 (1,345 × 900 × 320)	
Coil	Type		Cross fin coil		Cross fin coil	
	Rows×Stages×FPI		2 × 60 × 19		2 × 60 × 19	
	Face area	ft ² (m ²)	12.2 (1.134)		12.2 (1.134)	
Compressor	Model		2YC90FXD#A		2YC90FXD#A	
	Type		Hermetically sealed swing type		Hermetically sealed swing type	
	Motor output	kW	3.5		3.5	
Fan	Model		P47N		P47N	
	Type		Propeller fan		Propeller fan	
	Motor output	W	70 × 2		70 × 2	
	Airflow rate	cfm (m ³ /min)	3,741 (106)		3,741 (106)	
Weight		lbs (kg)	225 (102)		225 (102)	
Sound pressure level		dB(A)	57		57	
Connecting Pipes	Liquid Pipe	in (mm)	φ3/8 (φ9.5) (Flare connection)		φ3/8 (φ9.5) (Flare connection)	
	Gas Pipe	in (mm)	φ5/8 (φ15.9) (Flare connection)		φ5/8 (φ15.9) (Flare connection)	
	Drain Pipe	in (mm)	φ1 (φ26) (Hole)		φ1 (φ26) (Hole)	
Safety devices			High pressure switch, Outdoor fan driver overload protector, Inverter overload protector, Fusible plugs, Fuse		High pressure switch, Outdoor fan driver overload protector, Inverter overload protector, Fusible plugs, Fuse	
Capacity Control		%	14-100		14-100	
Refrigerant control			Electronic expansion valve		Electronic expansion valve	
Ref. piping	Standard length	ft (m)	25 (7.6)		25 (7.6)	
	Max. length	ft (m)	230 (70)		230 (70)	
	Max. height difference	ft (m)	98 (30)		98 (30)	
Refrigerant	Model		R-410A		R-410A	
	Charge	lbs (kg)	7.9 (3.6)		7.9 (3.6)	
Ref. oil	Model		DAPHNE FVC50K		DAPHNE FVC50K	
	Charge	L	1.52		1.52	
Drawing No.	Sound (outdoor)		C: 4D101949D		C: 4D101949D	

Notes:
 ★1 Indoor temp. : 80°FDB (26.7°CDB), 67°FWB (19.4°CWB) / Outdoor temp. : 95°FDB (35.0°CDB) / Equivalent piping length : 25 ft (7.6 m), level difference : 0 ft (0 m).
 ★2 Capacities are net, including a deduction for cooling (an addition for heating) for indoor fan motor heat.
 ★3 Air filter is not standard accessory (field supply parts), but please mount it in the duct system of the suction side.

Model name		Indoor unit		FTQ18TAVJUD, FTQ18TAVJUA		FTQ24TAVJUD, FTQ24TAVJUA	
		Outdoor unit		RZR18TBVJUA		RZR24TBVJUA	
Power supply				1 phase, 208/230 V, 60 Hz		1 phase, 208/230 V, 60 Hz	
★1 ★2 Cooling capacity		Btu/h (kW)		17,200 (5.0)		23,400 (6.9)	
EER2 (Rated)		Btu/h·W		11.7		9.9	
SEER2 (Rated)				15.6		16.2	
Indoor unit				FTQ18TAVJUD, FTQ18TAVJUA		FTQ24TAVJUD, FTQ24TAVJUA	
Casing color				Daikin Slate Gray		Daikin Slate Gray	
Dimensions: (H×W×D)		in (mm)		45 × 17.5 × 21 (1,143 × 445 × 533)		45 × 17.5 × 21 (1,143 × 445 × 533)	
Coil	Type			Cross fin coil		Cross fin coil	
Fan	Type			Sirocco FC Centrifugal		Sirocco FC Centrifugal	
	Motor output	HP		1/2		1/2	
	Airflow rate (H/M/L)	cfm (m ³ /min)		600/510/420 (17.0/14.4/11.9)		800/680/560 (22.7/19.3/15.9)	
	External static pressure	in. w.g.		0.1" - 0.9"		0.1" - 0.9"	
Air filter				— ★3		— ★3	
Weight		lbs (kg)		115 (52.2)		115 (52.2)	
Piping connections	Liquid	in (mm)		φ3/8 (φ9.5) (Brazing connection)		φ3/8 (φ9.5) (Brazing connection)	
	Gas	in (mm)		φ5/8 (φ15.9) (Brazing connection)		φ5/8 (φ15.9) (Brazing connection)	
	Drain	in (mm)		3/4" (19.1)		3/4" (19.1)	
Remote controller (accessory)	Wired			BRC1H71W, BRC1E73, BRC2A71		BRC1H71W, BRC1E73, BRC2A71	
	Wireless			BRC4C82		BRC4C82	
Outdoor unit				RZR18TBVJUA		RZR24TBVJUA	
Casing color				Ivory white		Ivory white	
Dimensions: (H×W×D)		in (mm)		39 × 37 × 12-5/8 (990 × 940 × 320)		39 × 37 × 12-5/8 (990 × 940 × 320)	
Coil	Type			Cross fin coil		Cross fin coil	
Compressor	Type			Hermetically sealed swing type		Hermetically sealed swing type	
	Motor output	kW		1.9		1.9	
Fan	Type			Propeller fan		Propeller fan	
	Motor output	W		200		200	
	Airflow rate	cfm (m ³ /min)		2,682 (76)		2,682 (76)	
Weight		lbs (kg)		172 (78)		172 (78)	
Piping connections	Liquid	in (mm)		φ3/8 (φ9.5) (Flare connection)		φ3/8 (φ9.5) (Flare connection)	
	Gas	in (mm)		φ5/8 (φ15.9) (Flare connection)		φ5/8 (φ15.9) (Flare connection)	
	Drain	in (mm)		φ1 (φ26) (Hole)		φ1 (φ26) (Hole)	
Safety devices				High pressure switch, Outdoor fan driver overload protector, Inverter overload protector, Fusible plugs, Fuse		High pressure switch, Outdoor fan driver overload protector, Inverter overload protector, Fusible plugs, Fuse	
Capacity step		%		14-100		14-100	
Refrigerant control				Electronic expansion valve		Electronic expansion valve	
Ref. piping	Standard length	ft (m)		25 (7.6)		25 (7.6)	
	Max. length	ft (m)		164 (50)		164 (50)	
	Max. height difference	ft (m)		98 (30)		98 (30)	
Refrigerant	Type			R-410A		R-410A	
	Charge	lbs (kg)		6.4 (2.9)		6.4 (2.9)	
Ref. oil	Type			DAPHNE FVC50K		DAPHNE FVC50K	
	Charge	L		1.08		1.08	

Notes:

★1 Indoor temp. : 80°FDB (26.7°CDB), 67°FWB (19.4°CWB) / Outdoor temp. : 95°FDB (35.0°CDB) / Equivalent piping length : 25 ft (7.6 m), height difference : 0 ft (0 m).

★2 Capacities are net, including a deduction for cooling for indoor fan motor heat.

★3 Air filter is not standard accessory (field supply parts), but please mount it in the duct system of the suction side.

Model name		Indoor unit		FTQ30TAVJUD, FTQ30TAVJUA		FTQ36TAVJUD, FTQ36TAVJUA	
		Outdoor unit		RZR30TBVJUA		RZR36TBVJUA	
Power supply				1 phase, 208/230 V, 60 Hz		1 phase, 208/230 V, 60 Hz	
★1 ★2 Cooling capacity		Btu/h (kW)		29,500 (8.6)		35,000 (10.3)	
EER2 (Rated)		Btu/h·W		11.9		11.2	
SEER2 (Rated)				15.6		16.4	
Indoor unit				FTQ30TAVJUD, FTQ30TAVJUA		FTQ36TAVJUD, FTQ36TAVJUA	
Casing color				Daikin Slate Gray		Daikin Slate Gray	
Dimensions: (H×W×D)		in (mm)		45 × 17.5 × 21 (1,143 × 445 × 533)		45 × 17.5 × 21 (1,143 × 445 × 533)	
Coil	Type			Cross fin coil		Cross fin coil	
Fan	Type			Sirocco FC Centrifugal		Sirocco FC Centrifugal	
	Motor output	HP		1/2		1/2	
	Airflow rate (H/M/L)	cfm (m³/min)		1,000/850/700 (28.3/24.1/19.8)		1,050/900/750 (29.7/25.5/21.2)	
	External static pressure	in. w.g.		0.1" - 0.9"		0.1" - 0.9"	
Air filter				— ★3		— ★3	
Weight		lbs (kg)		115 (52.2)		140 (63.5)	
Piping connections	Liquid	in (mm)		φ3/8 (φ9.5) (Braze connection)		φ3/8 (φ9.5) (Braze connection)	
	Gas	in (mm)		φ5/8 (φ15.9) (Braze connection)		φ5/8 (φ15.9) (Braze connection)	
	Drain	in (mm)		3/4" (19.1)		3/4" (19.1)	
Remote controller (accessory)	Wired			BRC1H71W, BRC1E73, BRC2A71		BRC1H71W, BRC1E73, BRC2A71	
	Wireless			BRC4C82		BRC4C82	
Outdoor unit				RZR30TBVJUA		RZR36TBVJUA	
Casing color				Ivory white		Ivory white	
Dimensions: (H×W×D)		in (mm)		52-15/16 × 35-7/16 × 12-5/8 (1,345 × 900 × 320)		52-15/16 × 35-7/16 × 12-5/8 (1,345 × 900 × 320)	
Coil	Type			Cross fin coil		Cross fin coil	
Compressor	Type			Hermetically sealed swing type		Hermetically sealed swing type	
	Motor output	kW		3.5		3.5	
Fan	Type			Propeller fan		Propeller fan	
	Motor output	W		70 × 2		70 × 2	
	Airflow rate	cfm (m³/min)		3,741 (106)		3,741 (106)	
Weight		lbs (kg)		225 (102)		225 (102)	
Piping connections	Liquid	in (mm)		φ3/8 (φ9.5) (Flare connection)		φ3/8 (φ9.5) (Flare connection)	
	Gas	in (mm)		φ5/8 (φ15.9) (Flare connection)		φ5/8 (φ15.9) (Flare connection)	
	Drain	in (mm)		φ1 (φ26) (Hole)		φ1 (φ26) (Hole)	
Safety devices				High pressure switch, Outdoor fan driver overload protector, Inverter overload protector, Fusible plugs, Fuse		High pressure switch, Outdoor fan driver overload protector, Inverter overload protector, Fusible plugs, Fuse	
Capacity step		%		14-100		14-100	
Refrigerant control				Electronic expansion valve		Electronic expansion valve	
Ref. piping	Standard length	ft (m)		25 (7.6)		25 (7.6)	
	Max. length	ft (m)		230 (70)		230 (70)	
	Max. height difference	ft (m)		98 (30)		98 (30)	
Refrigerant	Type			R-410A		R-410A	
	Charge	lbs (kg)		7.9 (3.6)		7.9 (3.6)	
Ref. oil	Type			DAPHNE FVC50K		DAPHNE FVC50K	
	Charge	L		1.52		1.52	

Notes:

- ★1 Indoor temp. : 80°FDB (26.7°CDB), 67°FWB (19.4°CWB) / Outdoor temp. : 95°FDB (35.0°CDB) / Equivalent piping length : 25 ft (7.6 m), height difference : 0 ft (0 m).
- ★2 Capacities are net, including a deduction for cooling for indoor fan motor heat.
- ★3 Air filter is not standard accessory (field supply parts), but please mount it in the duct system of the suction side.

Model name		Indoor unit		FTQ42TAVJUD, FTQ42TAVJUA		FTQ48TAVJUD, FTQ48TAVJUA	
		Outdoor unit		RZR42TBVJUA		RZR48TBVJUA	
Power supply				1 phase, 208/230 V, 60 Hz		1 phase, 208/230 V, 60 Hz	
★1 ★2 Cooling capacity		Btu/h (kW)		40,500 (11.9)		47,000 (13.8)	
EER2 (Rated)		Btu/h·W		10.6		9.1	
SEER2 (Rated)				16.0		15.3	
Indoor unit				FTQ42TAVJUD, FTQ42TAVJUA		FTQ48TAVJUD, FTQ48TAVJUA	
Casing color				Daikin Slate Gray		Daikin Slate Gray	
Dimensions: (H×W×D)		in (mm)		53.43 × 21 × 21 (1,357 × 533 × 533)		53.43 × 21 × 21 (1,357 × 533 × 533)	
Coil	Type			Cross fin coil		Cross fin coil	
	Type			Sirocco FC Centrifugal		Sirocco FC Centrifugal	
Fan	Motor output	HP		3/4		3/4	
	Airflow rate (H/M/L)	cfm (m ³ /min)		1,400/1,190/980 (39.7/33.7/27.8)		1,520/1,290/1,060 (43.1/36.5/30.0)	
	External static pressure	in. w.g.		0.1" - 0.9"		0.1" - 0.9"	
Air filter				— ★3		— ★3	
Weight		lbs (kg)		150 (68)		150 (68)	
Piping connections	Liquid	in (mm)		φ3/8 (φ9.5) (Brazing connection)		φ3/8 (φ9.5) (Brazing connection)	
	Gas	in (mm)		φ5/8 (φ15.9) (Brazing connection)		φ5/8 (φ15.9) (Brazing connection)	
	Drain	in (mm)		3/4" (19.1)		3/4" (19.1)	
Remote controller (accessory)	Wired			BRC1H71W, BRC1E73, BRC2A71		BRC1H71W, BRC1E73, BRC2A71	
	Wireless			BRC4C82		BRC4C82	
Outdoor unit				RZR42TBVJUA		RZR48TBVJUA	
Casing color				Ivory white		Ivory white	
Dimensions: (H×W×D)		in (mm)		52-15/16 × 35-7/16 × 12-5/8 (1,345 × 900 × 320)		52-15/16 × 35-7/16 × 12-5/8 (1,345 × 900 × 320)	
Coil	Type			Cross fin coil		Cross fin coil	
	Type			Hermetically sealed swing type		Hermetically sealed swing type	
Compressor	Motor output	kW		3.5		3.5	
	Type			Propeller fan		Propeller fan	
Fan	Motor output	W		70 × 2		70 × 2	
	Airflow rate	cfm (m ³ /min)		3,741 (106)		3,741 (106)	
Weight		lbs (kg)		225 (102)		225 (102)	
Piping connections	Liquid	in (mm)		φ3/8 (φ9.5) (Flare connection)		φ3/8 (φ9.5) (Flare connection)	
	Gas	in (mm)		φ5/8 (φ15.9) (Flare connection)		φ5/8 (φ15.9) (Flare connection)	
	Drain	in (mm)		φ1 (φ26) (Hole)		φ1 (φ26) (Hole)	
Safety devices				High pressure switch, Outdoor fan driver overload protector, Inverter overload protector, Fusible plugs, Fuse		High pressure switch, Outdoor fan driver overload protector, Inverter overload protector, Fusible plugs, Fuse	
Capacity step		%		14-100		14-100	
Refrigerant control				Electronic expansion valve		Electronic expansion valve	
Ref. piping	Standard length	ft (m)		25 (7.6)		25 (7.6)	
	Max. length	ft (m)		230 (70)		230 (70)	
	Max. height difference	ft (m)		98 (30)		98 (30)	
Refrigerant	Type			R-410A		R-410A	
	Charge	lbs (kg)		7.9 (3.6)		7.9 (3.6)	
Ref. oil	Type			DAPHNE FVC50K		DAPHNE FVC50K	
	Charge	L		1.52		1.52	

Notes:

★1 Indoor temp. : 80°FDB (26.7°CDB), 67°FWB (19.4°CWB) / Outdoor temp. : 95°FDB (35.0°CDB) / Equivalent piping length : 25 ft (7.6 m), height difference : 0 ft (0 m).

★2 Capacities are net, including a deduction for cooling for indoor fan motor heat.

★3 Air filter is not standard accessory (field supply parts), but please mount it in the duct system of the suction side.

3.2 Heat Pump

3.2.1 Ceiling Mounted Cassette Type (Round Flow with Sensing Panel)

Model name		Indoor unit		FCQ18TAVJU RZQ18TAVJU		FCQ24TAVJU RZQ24TAVJU	
Power supply				1 phase, 208/230 V, 60 Hz		1 phase, 208/230 V, 60 Hz	
★1 ★4 Cooling capacity	Btu/h (kW)			18,000 (5.3)		24,000 (7.0)	
★2 ★4 Heating capacity	Btu/h (kW)			20,000 (5.9)		27,000 (7.9)	
★3 ★4 Heating capacity	Btu/h (kW)			12,000 (3.5)		18,000 (5.3)	
SEER (Rated)				18.6		18.5	
EER (Rated)		Btu/h·W		13.0		12.0	
HSPF (Rated)				10.1		10.2	
Indoor unit				FCQ18TAVJU		FCQ24TAVJU	
Casing color				Galvanized steel plate		Galvanized steel plate	
Dimensions: (H×W×D)		in (mm)		10-1/16 × 33-1/16 × 33-1/16 (256 × 840 × 840)		10-1/16 × 33-1/16 × 33-1/16 (256 × 840 × 840)	
Coil	Type			Cross fin coil		Cross fin coil	
	Rows×Stages×FPI			3 × (12 + 15 × 2) × (20 + 21 × 2)		3 × (12 + 15 × 2) × (20 + 21 × 2)	
	Face area	ft ² (m ²)		4.59 (0.427)		4.59 (0.427)	
Fan	Model			QTS48C15M		QTS48C15M	
	Type			Turbo fan		Turbo fan	
	Motor output	W		48		48	
	Airflow rate (H/M/L)	cfm (m ³ /min)		742/618/477 (21.0/17.5/13.5)		777/618/477 (22.0/17.5/13.5)	
Sound pressure level (H/M/L)		dB(A)		35.5/32.0/28.0		36.0/32.0/28.0	
Air filter				—		—	
Weight		lbs (kg)		63 (28.5)		63 (28.5)	
Connecting Pipes	Liquid Pipe	in (mm)		φ3/8 (φ9.5) (Flare connection)		φ3/8 (φ9.5) (Flare connection)	
	Gas Pipe	in (mm)		φ5/8 (φ15.9) (Flare connection)		φ5/8 (φ15.9) (Flare connection)	
	Drain Pipe	in (mm)		VP25 (External dia. 1-1/4 (32), internal dia. 1 (26))		VP25 (External dia. 1-1/4 (32), internal dia. 1 (26))	
Remote controller (option)	Wired			BRC1E73, BRC2A71		BRC1E73, BRC2A71	
	Wireless			—		—	
Decoration panels (option)	Model			BYCQ125B-W1 / BYCQ125BGW1		BYCQ125B-W1 / BYCQ125BGW1	
	Color			Fresh white		Fresh white	
	Dimensions: (H×W×D)	in (mm)		2 × 37-3/8 × 37-3/8 / 5-1/8 × 37-3/8 × 37-3/8 (50 × 950 × 950 / 130 × 950 × 950)		2 × 37-3/8 × 37-3/8 / 5-1/8 × 37-3/8 × 37-3/8 (50 × 950 × 950 / 130 × 950 × 950)	
	Air filter			Resin net (with mold resistance)		Resin net (with mold resistance)	
	Weight	lbs (kg)		12.2 (5.5) / 22.1 (10.0)		12.2 (5.5) / 22.1 (10.0)	
Outdoor unit				RZQ18TAVJU		RZQ24TAVJU	
Casing color				Ivory white		Ivory white	
Dimensions: (H×W×D)		in (mm)		39 × 37 × 12-5/8 (990 × 940 × 320)		39 × 37 × 12-5/8 (990 × 940 × 320)	
Coil	Type			Cross fin coil		Cross fin coil	
	Rows×Stages×FPI			2 × 44 × 19		2 × 44 × 19	
	Face area	ft ² (m ²)		9.5 (0.88)		9.5 (0.88)	
Compressor	Model			2YC63ABXDD		2YC63ABXDD	
	Type			Hermetically sealed swing type		Hermetically sealed swing type	
	Motor output	kW		1.9		1.9	
Fan	Model			P51J11F		P51J11F	
	Type			Propeller fan		Propeller fan	
	Motor output	W		200		200	
	Airflow rate	cfm (m ³ /min)		2,682 (76)		2,682 (76)	
Weight		lbs (kg)		172 (78)		172 (78)	
Sound pressure level (Cooling/Heating)		dB(A)		58 / 61		58 / 61	
Connecting Pipes	Liquid Pipe	in (mm)		φ3/8 (φ9.5) (Flare connection)		φ3/8 (φ9.5) (Flare connection)	
	Gas Pipe	in (mm)		φ5/8 (φ15.9) (Flare connection)		φ5/8 (φ15.9) (Flare connection)	
	Drain Pipe	in (mm)		φ1 (φ26) (Hole)		φ1 (φ26) (Hole)	
Safety devices				High pressure switch, Outdoor fan driver overload protector, Inverter overload protector, Fusible plugs, Fuse		High pressure switch, Outdoor fan driver overload protector, Inverter overload protector, Fusible plugs, Fuse	
Capacity Control		%		14-100		14-100	
Refrigerant control				Electronic expansion valve		Electronic expansion valve	
Ref. piping	Standard length	ft (m)		25 (7.6)		25 (7.6)	
	Max. length	ft (m)		164 (50)		164 (50)	
	Max. height difference	ft (m)		98 (30)		98 (30)	
Refrigerant	Model			R-410A		R-410A	
	Charge	lbs (kg)		6.4 (2.9)		6.4 (2.9)	
Ref. oil	Model			DAPHNE FVC50K		DAPHNE FVC50K	
	Charge	L		1.08		1.08	
Drawing No.	Specification			C: 4D115508		C: 4D115508	
	Sound (indoor)			C: 4D087483B		C: 4D087474B	
	Sound (outdoor)			C: 4D101947D / C: 4D101948E		C: 4D101947D / C: 4D101948E	

Notes:

- ★1 Indoor temp.: 80°FDB (26.7°CDB), 67°FWB (19.4°CWB) / Outdoor temp.: 95°FDB (35.0°CDB) / Equivalent piping length: 25 ft (7.6 m), level difference: 0 ft (0 m).
- ★2 Indoor temp.: 70°FDB (21.1°CDB) / Outdoor temp.: 47°FDB (8.3°CDB), 43°FWB (6.1°CWB) / Equivalent piping length: 25 ft (7.6 m), level difference: 0 ft (0 m).
- ★3 Indoor temp.: 70°FDB (21.1°CDB) / Outdoor temp.: 17°FDB (-8.3°CDB), 15°FWB (-9.4°CWB) / Equivalent piping length: 25 ft (7.6 m), level difference: 0 ft (0 m).
- ★4 Capacities are net, including a deduction for cooling (an addition for heating) for indoor fan motor heat.

Model name	Indoor unit		FCQ30TAVJU	FCQ36TAVJU
	Outdoor unit		RZQ30TAVJU	RZQ36TAVJU
Power supply			1 phase, 208/230 V, 60 Hz	1 phase, 208/230 V, 60 Hz
★1 ★4 Cooling capacity	Btu/h (kW)		30,000 (8.8)	36,000 (10.6)
★2 ★4 Heating capacity	Btu/h (kW)		34,000 (10.0)	40,000 (11.7)
★3 ★4 Heating capacity	Btu/h (kW)		22,000 (6.4)	21,000 (6.2)
SEER (Rated)			17.2	17.6
EER (Rated)	Btu/h-W		9.3	11.4
HSPF (Rated)			10.2	9.0
Indoor unit			FCQ30TAVJU	FCQ36TAVJU
Casing color			Galvanized steel plate	Galvanized steel plate
Dimensions: (H×W×D)		in (mm)	11-23/32 × 33-1/16 × 33-1/16 (298 × 840 × 840)	11-23/32 × 33-1/16 × 33-1/16 (298 × 840 × 840)
Coil	Type		Cross fin coil	Cross fin coil
	Rows×Stages×FPI		3 × 18 × (20 + 21 × 2)	3 × 18 × (20 + 21 × 2)
	Face area	ft ² (m ²)	5.92 (0.550)	5.92 (0.550)
Fan	Model		QTS48C15M	QTS48C15M
	Type		Turbo fan	Turbo fan
	Motor output	W	106	106
	Airflow rate (H/M/L)	cfm (m ³ /min)	1,112/918/671 (31.5/26.0/19.0)	1,165/918/671 (33.0/26.0/19.0)
Sound pressure level (H/M/L)			43.5/38.0/32.0	44.0/38.0/32.0
Air filter			—	—
Weight		lbs (kg)	70 (31.5)	70 (31.5)
Connecting Pipes	Liquid Pipe	in (mm)	φ3/8 (φ9.5) (Flare connection)	φ3/8 (φ9.5) (Flare connection)
	Gas Pipe	in (mm)	φ5/8 (φ15.9) (Flare connection)	φ5/8 (φ15.9) (Flare connection)
	Drain Pipe	in (mm)	VP25 (External dia. 1-1/4 (32), internal dia. 1 (26))	VP25 (External dia. 1-1/4 (32), internal dia. 1 (26))
Remote controller (option)	Wired		BRC1E73, BRC2A71	BRC1E73, BRC2A71
	Wireless		—	—
Decoration panels (option)	Model		BYCQ125B-W1 / BYCQ125BGW1	BYCQ125B-W1 / BYCQ125BGW1
	Color		Fresh white	Fresh white
	Dimensions: (H×W×D)	in (mm)	2 × 37-3/8 × 37-3/8 / 5-1/8 × 37-3/8 × 37-3/8 (50 × 950 × 950 / 130 × 950 × 950)	2 × 37-3/8 × 37-3/8 / 5-1/8 × 37-3/8 × 37-3/8 (50 × 950 × 950 / 130 × 950 × 950)
	Air filter		Resin net (with mold resistance)	Resin net (with mold resistance)
	Weight	lbs (kg)	12.2 (5.5) / 22.1 (10.0)	12.2 (5.5) / 22.1 (10.0)
Outdoor unit			RZQ30TAVJU	RZQ36TAVJU
Casing color			Ivory white	Ivory white
Dimensions: (H×W×D)		in (mm)	52-15/16 × 35-7/16 × 12-5/8 (1,345 × 900 × 320)	52-15/16 × 35-7/16 × 12-5/8 (1,345 × 900 × 320)
Coil	Type		Cross fin coil	Cross fin coil
	Rows×Stages×FPI		2 × 60 × 19	2 × 60 × 19
	Face area	ft ² (m ²)	12.2 (1.134)	12.2 (1.134)
Compressor	Model		2YC90GXD#D	2YC90GXD#D
	Type		Hermetically sealed swing type	Hermetically sealed swing type
	Motor output	kW	3.5	3.5
Fan	Model		P47N	P47N
	Type		Propeller fan	Propeller fan
	Motor output	W	70 × 2	70 × 2
	Airflow rate	cfm (m ³ /min)	3,741 (106)	3,741 (106)
Weight		lbs (kg)	225 (102)	225 (102)
Sound pressure level (Cooling/Heating)		dB(A)	57 / 59	57 / 59
Connecting Pipes	Liquid Pipe	in (mm)	φ3/8 (φ9.5) (Flare connection)	φ3/8 (φ9.5) (Flare connection)
	Gas Pipe	in (mm)	φ5/8 (φ15.9) (Flare connection)	φ5/8 (φ15.9) (Flare connection)
	Drain Pipe	in (mm)	φ1 (φ26) (Hole)	φ1 (φ26) (Hole)
Safety devices			High pressure switch, Outdoor fan driver overload protector, Inverter overload protector, Fusible plugs, Fuse	High pressure switch, Outdoor fan driver overload protector, Inverter overload protector, Fusible plugs, Fuse
Capacity Control		%	14-100	14-100
Refrigerant control			Electronic expansion valve	Electronic expansion valve
Ref. piping	Standard length	ft (m)	25 (7.6)	25 (7.6)
	Max. length	ft (m)	230 (70)	230 (70)
	Max. height difference	ft (m)	98 (30)	98 (30)
Refrigerant	Model		R-410A	R-410A
	Charge	lbs (kg)	7.9 (3.6)	7.9 (3.6)
Ref. oil	Model		DAPHNE FVC50K	DAPHNE FVC50K
	Charge	L	1.52	1.52
Drawing No.	Specification		C: 4D115510	C: 4D115510
	Sound (indoor)		C: 4D087479B	C: 4D087475B
	Sound (outdoor)		C: 4D101949D / C: 4D101950E	C: 4D101949D / C: 4D101950E

Notes:

- ★1 Indoor temp.: 80°FDB (26.7°CDB), 67°FWB (19.4°CWB) / Outdoor temp.: 95°FDB (35.0°CDB) / Equivalent piping length: 25 ft (7.6 m), level difference: 0 ft (0 m).
★2 Indoor temp.: 70°FDB (21.1°CDB) / Outdoor temp.: 47°FDB (8.3°CDB), 43°FWB (6.1°CWB) / Equivalent piping length: 25 ft (7.6 m), level difference: 0 ft (0 m).
★3 Indoor temp.: 70°FDB (21.1°CDB) / Outdoor temp.: 17°FDB (-9.3°CDB), 15°FWB (-9.4°CWB) / Equivalent piping length: 25 ft (7.6 m), level difference: 0 ft (0 m).
★4 Capacities are net, including a deduction for cooling (an addition for heating) for indoor fan motor heat.

Model name	Indoor unit		FCQ42TAVJU	FCQ48TAVJU
	Outdoor unit		RZQ42TAVJU	RZQ48TAVJU
Power supply			1 phase, 208/230 V, 60 Hz	1 phase, 208/230 V, 60 Hz
★1 ★4 Cooling capacity	Btu/h (kW)		42,000 (12.3)	48,000 (14.1)
★2 ★4 Heating capacity	Btu/h (kW)		47,000 (13.8)	54,000 (15.8)
★3 ★4 Heating capacity	Btu/h (kW)		25,000 (7.3)	28,000 (8.2)
SEER (Rated)			17.0	17.0
EER (Rated)			10.3	9.0
HSPF (Rated)			8.6	9.3
Indoor unit			FCQ42TAVJU	FCQ48TAVJU
Casing color			Galvanized steel plate	Galvanized steel plate
Dimensions: (H×W×D)			11-23/32 × 33-1/16 × 33-1/16 (298 × 840 × 840)	11-23/32 × 33-1/16 × 33-1/16 (298 × 840 × 840)
Coil	Type		Cross fin coil	Cross fin coil
	Rows×Stages×FPI		3 × 18 × (20 + 21 × 2)	3 × 18 × (20 + 21 × 2)
	Face area	ft ² (m ²)	5.92 (0.550)	5.92 (0.550)
Fan	Model		QTS48C15M	QTS48C15M
	Type		Turbo fan	Turbo fan
	Motor output	W	106	106
	Airflow rate (H/M/L)	cfm (m ³ /min)	1,218/971/742 (34.5/27.5/21.0)	1,218/971/742 (34.5/27.5/21.0)
Sound pressure level (H/M/L)			45.0/40.0/35.0	45.0/40.0/35.0
Air filter			—	—
Weight			70 (31.5)	70 (31.5)
Connecting Pipes	Liquid Pipe	in (mm)	φ3/8 (φ9.5) (Flare connection)	φ3/8 (φ9.5) (Flare connection)
	Gas Pipe	in (mm)	φ5/8 (φ15.9) (Flare connection)	φ5/8 (φ15.9) (Flare connection)
	Drain Pipe	in (mm)	VP25 (External dia. 1-1/4 (32), internal dia. 1 (26))	VP25 (External dia. 1-1/4 (32), internal dia. 1 (26))
Remote controller (option)	Wired		BRC1E73, BRC2A71	BRC1E73, BRC2A71
	Wireless		—	—
Decoration panels (option)	Model		BYCQ125B-W1 / BYCQ125BGW1	BYCQ125B-W1 / BYCQ125BGW1
	Color		Fresh white	Fresh white
	Dimensions: (H×W×D)	in (mm)	2 × 37-3/8 × 37-3/8 / 5-1/8 × 37-3/8 × 37-3/8 (50 × 950 × 950 / 130 × 950 × 950)	2 × 37-3/8 × 37-3/8 / 5-1/8 × 37-3/8 × 37-3/8 (50 × 950 × 950 / 130 × 950 × 950)
	Air filter		Resin net (with mold resistance)	Resin net (with mold resistance)
	Weight	lbs (kg)	12.2 (5.5) / 22.1 (10.0)	12.2 (5.5) / 22.1 (10.0)
Outdoor unit			RZQ42TAVJU	RZQ48TAVJU
Casing color			Ivory white	Ivory white
Dimensions: (H×W×D)			52-15/16 × 35-7/16 × 12-5/8 (1,345 × 900 × 320)	52-15/16 × 35-7/16 × 12-5/8 (1,345 × 900 × 320)
Coil	Type		Cross fin coil	Cross fin coil
	Rows×Stages×FPI		2 × 60 × 19	2 × 60 × 19
	Face area	ft ² (m ²)	12.2 (1.134)	12.2 (1.134)
Compressor	Model		2YC90GXD#D	2YC90GXD#D
	Type		Hermetically sealed swing type	Hermetically sealed swing type
	Motor output	kW	3.5	3.5
Fan	Model		P47N	P47N
	Type		Propeller fan	Propeller fan
	Motor output	W	70 × 2	70 × 2
	Airflow rate	cfm (m ³ /min)	3,741 (106)	3,741 (106)
Weight			225 (102)	225 (102)
Sound pressure level (Cooling/Heating)			57 / 59	57 / 59
Connecting Pipes	Liquid Pipe	in (mm)	φ3/8 (φ9.5) (Flare connection)	φ3/8 (φ9.5) (Flare connection)
	Gas Pipe	in (mm)	φ5/8 (φ15.9) (Flare connection)	φ5/8 (φ15.9) (Flare connection)
	Drain Pipe	in (mm)	φ1 (φ26) (Hole)	φ1 (φ26) (Hole)
Safety devices			High pressure switch, Outdoor fan driver overload protector, Inverter overload protector, Fusible plugs, Fuse	High pressure switch, Outdoor fan driver overload protector, Inverter overload protector, Fusible plugs, Fuse
Capacity Control			14-100	14-100
Refrigerant control			Electronic expansion valve	Electronic expansion valve
Ref. piping	Standard length	ft (m)	25 (7.6)	25 (7.6)
	Max. length	ft (m)	230 (70)	230 (70)
	Max. height difference	ft (m)	98 (30)	98 (30)
Refrigerant	Model		R-410A	R-410A
	Charge	lbs (kg)	7.9 (3.6)	7.9 (3.6)
Ref. oil	Model		DAPHNE FVC50K	DAPHNE FVC50K
	Charge	L	1.52	1.52
Drawing No.	Specification		C: 4D115510	C: 4D115510
	Sound (indoor)		C: 4D087476B	C: 4D087476B
	Sound (outdoor)		C: 4D101949D / C: 4D101950E	C: 4D101949D / C: 4D101950E

Notes:

- ★1 Indoor temp.: 80°FDB (26.7°CDB), 67°FWB (19.4°CWB) / Outdoor temp.: 95°FDB (35.0°CDB) / Equivalent piping length: 25 ft (7.6 m), level difference: 0 ft (0 m).
- ★2 Indoor temp.: 70°FDB (21.1°CDB) / Outdoor temp.: 47°FDB (8.3°CDB), 43°FWB (6.1°CWB) / Equivalent piping length: 25 ft (7.6 m), level difference: 0 ft (0 m).
- ★3 Indoor temp.: 70°FDB (21.1°CDB) / Outdoor temp.: 17°FDB (-9.3°CDB), 15°FWB (-9.4°CWB) / Equivalent piping length: 25 ft (7.6 m), level difference: 0 ft (0 m).
- ★4 Capacities are net, including a deduction for cooling (an addition for heating) for indoor fan motor heat.

Model name	Indoor unit		FCQ18TAVJU		FCQ24TAVJU	
	Outdoor unit		RZQ18TAVJUA		RZQ24TAVJUA	
Power supply			1 phase, 208/230 V, 60 Hz		1 phase, 208/230 V, 60 Hz	
★1 ★4 Cooling capacity	Btu/h (kW)		18,000 (5.3)		24,000 (7.0)	
★2 ★4 Heating capacity	Btu/h (kW)		20,000 (5.9)		27,000 (7.9)	
★3 ★4 Heating capacity	Btu/h (kW)		12,000 (3.5)		18,000 (5.3)	
SEER (Rated)			18.6		18.5	
EER (Rated)			13.0		12.0	
HSPF (Rated)			10.1		10.2	
Indoor unit			FCQ18TAVJU		FCQ24TAVJU	
Casing color			Galvanized steel plate		Galvanized steel plate	
Dimensions: (H×W×D)			10-1/16 × 33-1/16 × 33-1/16 (256 × 840 × 840)		10-1/16 × 33-1/16 × 33-1/16 (256 × 840 × 840)	
Coil	Type		Cross fin coil		Cross fin coil	
	Rows×Stages×FPI		3 × (12 + 15 × 2) × (20 + 21 × 2)		3 × (12 + 15 × 2) × (20 + 21 × 2)	
	Face area	ft ² (m ²)	4.59 (0.427)		4.59 (0.427)	
Fan	Model		QTS48C15M		QTS48C15M	
	Type		Turbo fan		Turbo fan	
	Motor output	W	48		48	
	Airflow rate (H/M/L)	cfm (m ³ /min)	742/618/477 (21.0/17.5/13.5)		777/618/477 (22.0/17.5/13.5)	
Sound pressure level (H/M/L)			35.5/32.0/28.0		36.0/32.0/28.0	
Air filter			—		—	
Weight			63 (28.5)		63 (28.5)	
Connecting Pipes	Liquid Pipe	in (mm)	φ3/8 (φ9.5) (Flare connection)		φ3/8 (φ9.5) (Flare connection)	
	Gas Pipe	in (mm)	φ5/8 (φ15.9) (Flare connection)		φ5/8 (φ15.9) (Flare connection)	
	Drain Pipe	in (mm)	VP25 (External dia. 1-1/4 (32), internal dia. 1 (26))		VP25 (External dia. 1-1/4 (32), internal dia. 1 (26))	
Remote controller (option)	Wired		BRC1E73, BRC2A71		BRC1E73, BRC2A71	
	Wireless		—		—	
Decoration panels (option)	Model		BYCQ125B-W1 / BYCQ125BGW1		BYCQ125B-W1 / BYCQ125BGW1	
	Color		Fresh white		Fresh white	
	Dimensions: (H×W×D)	in (mm)	2 × 37-3/8 × 37-3/8 / 5-1/8 × 37-3/8 × 37-3/8 (50 × 950 × 950 / 130 × 950 × 950)		2 × 37-3/8 × 37-3/8 / 5-1/8 × 37-3/8 × 37-3/8 (50 × 950 × 950 / 130 × 950 × 950)	
	Air filter		Resin net (with mold resistance)		Resin net (with mold resistance)	
	Weight	lbs (kg)	12.2 (5.5) / 22.1 (10.0)		12.2 (5.5) / 22.1 (10.0)	
Outdoor unit			RZQ18TAVJUA		RZQ24TAVJUA	
Casing color			Ivory white		Ivory white	
Dimensions: (H×W×D)			39 × 37 × 12-5/8 (990 × 940 × 320)		39 × 37 × 12-5/8 (990 × 940 × 320)	
Coil	Type		Cross fin coil		Cross fin coil	
	Rows×Stages×FPI		2 × 44 × 19		2 × 44 × 19	
	Face area	ft ² (m ²)	9.5 (0.88)		9.5 (0.88)	
Compressor	Model		2YC63TXD#A		2YC63TXD#A	
	Type		Hermetically sealed swing type		Hermetically sealed swing type	
	Motor output	kW	1.9		1.9	
Fan	Model		P51J11F		P51J11F	
	Type		Propeller fan		Propeller fan	
	Motor output	W	200		200	
	Airflow rate	cfm (m ³ /min)	2,682 (76)		2,682 (76)	
Weight			172 (78)		172 (78)	
Sound pressure level (Cooling/Heating)			58 / 61		58 / 61	
Connecting Pipes	Liquid Pipe	in (mm)	φ3/8 (φ9.5) (Flare connection)		φ3/8 (φ9.5) (Flare connection)	
	Gas Pipe	in (mm)	φ5/8 (φ15.9) (Flare connection)		φ5/8 (φ15.9) (Flare connection)	
	Drain Pipe	in (mm)	φ1 (φ26) (Hole)		φ1 (φ26) (Hole)	
Safety devices			High pressure switch, Outdoor fan driver overload protector, Inverter overload protector, Fusible plugs, Fuse		High pressure switch, Outdoor fan driver overload protector, Inverter overload protector, Fusible plugs, Fuse	
Capacity Control			14-100		14-100	
Refrigerant control			Electronic expansion valve		Electronic expansion valve	
Ref. piping	Standard length	ft (m)	25 (7.6)		25 (7.6)	
	Max. length	ft (m)	164 (50)		164 (50)	
	Max. height difference	ft (m)	98 (30)		98 (30)	
Refrigerant	Model		R-410A		R-410A	
	Charge	lbs (kg)	6.4 (2.9)		6.4 (2.9)	
Ref. oil	Model		DAPHNE FVC50K		DAPHNE FVC50K	
	Charge	L	1.08		1.08	
Drawing No.	Specification		C: 4D126344		C: 4D126344	
	Sound (indoor)		C: 4D087483B		C: 4D087474B	
	Sound (outdoor)		C: 4D101947D / C: 4D101948E		C: 4D101947D / C: 4D101948E	

Notes:

- ★1 Indoor temp.: 80°FDB (26.7°CDB), 67°FWB (19.4°CWB) / Outdoor temp.: 95°FDB (35.0°CDB) / Equivalent piping length: 25 ft (7.6 m), level difference: 0 ft (0 m).
★2 Indoor temp.: 70°FDB (21.1°CDB) / Outdoor temp.: 47°FDB (8.3°CDB), 43°FWB (6.1°CWB) / Equivalent piping length: 25 ft (7.6 m), level difference: 0 ft (0 m).
★3 Indoor temp.: 70°FDB (21.1°CDB) / Outdoor temp.: 17°FDB (-9.4°CDB), 15°FWB (-9.4°CWB) / Equivalent piping length: 25 ft (7.6 m), level difference: 0 ft (0 m).
★4 Capacities are net, including a deduction for cooling (an addition for heating) for indoor fan motor heat.

Model name	Indoor unit		FCQ30TAVJU	FCQ36TAVJU
	Outdoor unit		RZQ30TAVJUA	RZQ36TAVJUA
Power supply			1 phase, 208/230 V, 60 Hz	1 phase, 208/230 V, 60 Hz
★1 ★4 Cooling capacity	Btu/h (kW)		30,000 (8.8)	36,000 (10.6)
★2 ★4 Heating capacity	Btu/h (kW)		34,000 (10.0)	40,000 (11.7)
★3 ★4 Heating capacity	Btu/h (kW)		22,000 (6.4)	21,000 (6.2)
SEER (Rated)			17.2	17.6
EER (Rated)	Btu/h-W		9.3	11.4
HSPF (Rated)			10.2	9.0
Indoor unit			FCQ30TAVJU	FCQ36TAVJU
Casing color			Galvanized steel plate	Galvanized steel plate
Dimensions: (H×W×D)		in (mm)	11-23/32 × 33-1/16 × 33-1/16 (298 × 840 × 840)	11-23/32 × 33-1/16 × 33-1/16 (298 × 840 × 840)
Coil	Type		Cross fin coil	Cross fin coil
	Rows×Stages×FPI		3 × 18 × (20 + 21 × 2)	3 × 18 × (20 + 21 × 2)
	Face area	ft ² (m ²)	5.92 (0.550)	5.92 (0.550)
Fan	Model		QTS48C15M	QTS48C15M
	Type		Turbo fan	Turbo fan
	Motor output	W	106	106
	Airflow rate (H/M/L)	cfm (m ³ /min)	1,112/918/671 (31.5/26.0/19.0)	1,165/918/671 (33.0/26.0/19.0)
Sound pressure level (H/M/L)			43.5/38.0/32.0	44.0/38.0/32.0
Air filter			—	—
Weight		lbs (kg)	70 (31.5)	70 (31.5)
Connecting Pipes	Liquid Pipe	in (mm)	φ3/8 (φ9.5) (Flare connection)	φ3/8 (φ9.5) (Flare connection)
	Gas Pipe	in (mm)	φ5/8 (φ15.9) (Flare connection)	φ5/8 (φ15.9) (Flare connection)
	Drain Pipe	in (mm)	VP25 (External dia. 1-1/4 (32), internal dia. 1 (26))	VP25 (External dia. 1-1/4 (32), internal dia. 1 (26))
Remote controller (option)	Wired		BRC1E73, BRC2A71	BRC1E73, BRC2A71
	Wireless		—	—
Decoration panels (option)	Model		BYCQ125B-W1 / BYCQ125BGW1	BYCQ125B-W1 / BYCQ125BGW1
	Color		Fresh white	Fresh white
	Dimensions: (H×W×D)	in (mm)	2 × 37-3/8 × 37-3/8 / 5-1/8 × 37-3/8 × 37-3/8 (50 × 950 × 950 / 130 × 950 × 950)	2 × 37-3/8 × 37-3/8 / 5-1/8 × 37-3/8 × 37-3/8 (50 × 950 × 950 / 130 × 950 × 950)
	Air filter		Resin net (with mold resistance)	Resin net (with mold resistance)
	Weight	lbs (kg)	12.2 (5.5) / 22.1 (10.0)	12.2 (5.5) / 22.1 (10.0)
Outdoor unit			RZQ30TAVJUA	RZQ36TAVJUA
Casing color			Ivory white	Ivory white
Dimensions: (H×W×D)		in (mm)	52-15/16 × 35-7/16 × 12-5/8 (1,345 × 900 × 320)	52-15/16 × 35-7/16 × 12-5/8 (1,345 × 900 × 320)
Coil	Type		Cross fin coil	Cross fin coil
	Rows×Stages×FPI		2 × 60 × 19	2 × 60 × 19
	Face area	ft ² (m ²)	12.2 (1.134)	12.2 (1.134)
Compressor	Model		2YC90FXD#A	2YC90FXD#A
	Type		Hermetically sealed swing type	Hermetically sealed swing type
	Motor output	kW	3.5	3.5
Fan	Model		P47N	P47N
	Type		Propeller fan	Propeller fan
	Motor output	W	70 × 2	70 × 2
	Airflow rate	cfm (m ³ /min)	3,741 (106)	3,741 (106)
Weight		lbs (kg)	225 (102)	225 (102)
Sound pressure level (Cooling/Heating)		dB(A)	57 / 59	57 / 59
Connecting Pipes	Liquid Pipe	in (mm)	φ3/8 (φ9.5) (Flare connection)	φ3/8 (φ9.5) (Flare connection)
	Gas Pipe	in (mm)	φ5/8 (φ15.9) (Flare connection)	φ5/8 (φ15.9) (Flare connection)
	Drain Pipe	in (mm)	φ1 (φ26) (Hole)	φ1 (φ26) (Hole)
Safety devices			High pressure switch, Outdoor fan driver overload protector, Inverter overload protector, Fusible plugs, Fuse	High pressure switch, Outdoor fan driver overload protector, Inverter overload protector, Fusible plugs, Fuse
Capacity Control		%	14-100	14-100
Refrigerant control			Electronic expansion valve	Electronic expansion valve
Ref. piping	Standard length	ft (m)	25 (7.6)	25 (7.6)
	Max. length	ft (m)	230 (70)	230 (70)
	Max. height difference	ft (m)	98 (30)	98 (30)
Refrigerant	Model		R-410A	R-410A
	Charge	lbs (kg)	7.9 (3.6)	7.9 (3.6)
Ref. oil	Model		DAPHNE FVC50K	DAPHNE FVC50K
	Charge	L	1.52	1.52
Drawing No.	Specification		C: 4D126345	C: 4D126345
	Sound (indoor)		C: 4D087479B	C: 4D087475B
	Sound (outdoor)		C: 4D101949D / C: 4D101950E	C: 4D101949D / C: 4D101950E

Notes:

- ★1 Indoor temp.: 80°FDB (26.7°CDB), 67°FWB (19.4°CWB) / Outdoor temp.: 95°FDB (35.0°CDB) / Equivalent piping length: 25 ft (7.6 m), level difference: 0 ft (0 m).
- ★2 Indoor temp.: 70°FDB (21.1°CDB) / Outdoor temp.: 47°FDB (8.3°CDB), 43°FWB (6.1°CWB) / Equivalent piping length: 25 ft (7.6 m), level difference: 0 ft (0 m).
- ★3 Indoor temp.: 70°FDB (21.1°CDB) / Outdoor temp.: 17°FDB (-9.3°CDB), 15°FWB (-9.4°CWB) / Equivalent piping length: 25 ft (7.6 m), level difference: 0 ft (0 m).
- ★4 Capacities are net, including a deduction for cooling (an addition for heating) for indoor fan motor heat.

Model name	Indoor unit		FCQ42TAVJU	FCQ48TAVJU
	Outdoor unit		RZQ42TAVJUA	RZQ48TAVJUA
Power supply			1 phase, 208/230 V, 60 Hz	1 phase, 208/230 V, 60 Hz
★1 ★4 Cooling capacity	Btu/h (kW)		42,000 (12.3)	48,000 (14.1)
★2 ★4 Heating capacity	Btu/h (kW)		47,000 (13.8)	54,000 (15.8)
★3 ★4 Heating capacity	Btu/h (kW)		25,000 (7.3)	28,000 (8.2)
SEER (Rated)			17.0	17.0
EER (Rated)			10.3	9.0
HSPF (Rated)			8.6	9.3
Indoor unit			FCQ42TAVJU	FCQ48TAVJU
Casing color			Galvanized steel plate	Galvanized steel plate
Dimensions: (H×W×D)			11-23/32 × 33-1/16 × 33-1/16 (298 × 840 × 840)	11-23/32 × 33-1/16 × 33-1/16 (298 × 840 × 840)
Coil	Type		Cross fin coil	Cross fin coil
	Rows×Stages×FPI		3 × 18 × (20 + 21 × 2)	3 × 18 × (20 + 21 × 2)
	Face area	ft ² (m ²)	5.92 (0.550)	5.92 (0.550)
Fan	Model		QTS48C15M	QTS48C15M
	Type		Turbo fan	Turbo fan
	Motor output	W	106	106
	Airflow rate (H/M/L)	cfm (m ³ /min)	1,218/971/742 (34.5/27.5/21.0)	1,218/971/742 (34.5/27.5/21.0)
Sound pressure level (H/M/L)			45.0/40.0/35.0	45.0/40.0/35.0
Air filter			—	—
Weight			70 (31.5)	70 (31.5)
Connecting Pipes	Liquid Pipe	in (mm)	φ3/8 (φ9.5) (Flare connection)	φ3/8 (φ9.5) (Flare connection)
	Gas Pipe	in (mm)	φ5/8 (φ15.9) (Flare connection)	φ5/8 (φ15.9) (Flare connection)
	Drain Pipe	in (mm)	VP25 (External dia. 1-1/4 (32), internal dia. 1 (26))	VP25 (External dia. 1-1/4 (32), internal dia. 1 (26))
Remote controller (option)	Wired		BRC1E73, BRC2A71	BRC1E73, BRC2A71
	Wireless		—	—
Decoration panels (option)	Model		BYCQ125B-W1 / BYCQ125BGW1	BYCQ125B-W1 / BYCQ125BGW1
	Color		Fresh white	Fresh white
	Dimensions: (H×W×D)	in (mm)	2 × 37-3/8 × 37-3/8 / 5-1/8 × 37-3/8 × 37-3/8 (50 × 950 × 950 / 130 × 950 × 950)	2 × 37-3/8 × 37-3/8 / 5-1/8 × 37-3/8 × 37-3/8 (50 × 950 × 950 / 130 × 950 × 950)
	Air filter		Resin net (with mold resistance)	Resin net (with mold resistance)
	Weight	lbs (kg)	12.2 (5.5) / 22.1 (10.0)	12.2 (5.5) / 22.1 (10.0)
Outdoor unit			RZQ42TAVJUA	RZQ48TAVJUA
Casing color			Ivory white	Ivory white
Dimensions: (H×W×D)			52-15/16 × 35-7/16 × 12-5/8 (1,345 × 900 × 320)	52-15/16 × 35-7/16 × 12-5/8 (1,345 × 900 × 320)
Coil	Type		Cross fin coil	Cross fin coil
	Rows×Stages×FPI		2 × 60 × 19	2 × 60 × 19
	Face area	ft ² (m ²)	12.2 (1.134)	12.2 (1.134)
Compressor	Model		2YC90FXD#A	2YC90FXD#A
	Type		Hermetically sealed swing type	Hermetically sealed swing type
	Motor output	kW	3.5	3.5
Fan	Model		P47N	P47N
	Type		Propeller fan	Propeller fan
	Motor output	W	70 × 2	70 × 2
	Airflow rate	cfm (m ³ /min)	3,741 (106)	3,741 (106)
Weight			225 (102)	225 (102)
Sound pressure level (Cooling/Heating)			57 / 59	57 / 59
Connecting Pipes	Liquid Pipe	in (mm)	φ3/8 (φ9.5) (Flare connection)	φ3/8 (φ9.5) (Flare connection)
	Gas Pipe	in (mm)	φ5/8 (φ15.9) (Flare connection)	φ5/8 (φ15.9) (Flare connection)
	Drain Pipe	in (mm)	φ1 (φ26) (Hole)	φ1 (φ26) (Hole)
Safety devices			High pressure switch, Outdoor fan driver overload protector, Inverter overload protector, Fusible plugs, Fuse	High pressure switch, Outdoor fan driver overload protector, Inverter overload protector, Fusible plugs, Fuse
Capacity Control			14-100	14-100
Refrigerant control			Electronic expansion valve	Electronic expansion valve
Ref. piping	Standard length	ft (m)	25 (7.6)	25 (7.6)
	Max. length	ft (m)	230 (70)	230 (70)
	Max. height difference	ft (m)	98 (30)	98 (30)
Refrigerant	Model		R-410A	R-410A
	Charge	lbs (kg)	7.9 (3.6)	7.9 (3.6)
Ref. oil	Model		DAPHNE FVC50K	DAPHNE FVC50K
	Charge	L	1.52	1.52
Drawing No.	Specification		C: 4D126345	C: 4D126345
	Sound (indoor)		C: 4D087476B	C: 4D087476B
	Sound (outdoor)		C: 4D101949D / C: 4D101950E	C: 4D101949D / C: 4D101950E

Notes:

- ★1 Indoor temp.: 80°FDB (26.7°CDB), 67°FWB (19.4°CWB) / Outdoor temp.: 95°FDB (35.0°CDB) / Equivalent piping length: 25 ft (7.6 m), level difference: 0 ft (0 m).
★2 Indoor temp.: 70°FDB (21.1°CDB) / Outdoor temp.: 47°FDB (8.3°CDB), 43°FWB (6.1°CWB) / Equivalent piping length: 25 ft (7.6 m), level difference: 0 ft (0 m).
★3 Indoor temp.: 70°FDB (21.1°CDB) / Outdoor temp.: 17°FDB (-9.4°CDB), 15°FWB (-9.4°CWB) / Equivalent piping length: 25 ft (7.6 m), level difference: 0 ft (0 m).
★4 Capacities are net, including a deduction for cooling (an addition for heating) for indoor fan motor heat.

Model name		Indoor unit	FCQ18AAVJU	FCQ24AAVJU
		Outdoor unit	RZQ18TBVJUA	RZQ24TBVJUA
Power supply			1 phase, 208/230 V, 60 Hz	1 phase, 208/230 V, 60 Hz
★1 ★4 Cooling capacity	Btu/h (kW)		18,000 (5.3)	24,000 (7.0)
★2 ★4 Heating capacity	Btu/h (kW)		20,000 (5.9)	27,000 (7.9)
★3 ★4 Heating capacity	Btu/h (kW)		12,300 (3.6)	18,000 (5.3)
Indoor unit			FCQ18AAVJU	FCQ24AAVJU
Casing color			Galvanized steel plate	Galvanized steel plate
Dimensions: (H×W×D)		in (mm)	9-11/16 × 33-1/16 × 33-1/16 (246 × 840 × 840)	9-11/16 × 33-1/16 × 33-1/16 (246 × 840 × 840)
Coil	Type		Cross fin coil	Cross fin coil
Fan	Type		Turbo fan	Turbo fan
	Motor output	W	53	53
	Airflow rate (H/M/L)	cfm (m ³ /min)	742/618/477 (21.0/17.5/13.5)	777/618/477 (22.0/17.5/13.5)
Sound pressure level (H/M/L)			38.0/32.0/28.0	38.0/32.0/28.0
Air filter			—	—
Weight		lbs (kg)	51 (23)	51 (23)
Connecting Pipes	Liquid Pipe	in (mm)	φ3/8 (φ9.5) (Flare connection)	φ3/8 (φ9.5) (Flare connection)
	Gas Pipe	in (mm)	φ5/8 (φ15.9) (Flare connection)	φ5/8 (φ15.9) (Flare connection)
	Drain Pipe	in (mm)	VP25 (External dia. 1-1/4 (32), internal dia. 1 (26))	VP25 (External dia. 1-1/4 (32), internal dia. 1 (26))
Remote controller (accessory)	Wired		BRC1E73, BRC1H71W	BRC1E73, BRC1H71W
	Wireless		—	—
Decoration panels (accessory)	Model		BYCQ54EEFU / BYCQ54EEGFU	BYCQ54EEFU / BYCQ54EEGFU
	Color		Fresh white	Fresh white
	Dimensions: (H×W×D)	in (mm)	2 × 37-3/8 × 37-3/8 / 5-1/8 × 37-3/8 × 37-3/8 (50 × 950 × 950 / 130 × 950 × 950)	2 × 37-3/8 × 37-3/8 / 5-1/8 × 37-3/8 × 37-3/8 (50 × 950 × 950 / 130 × 950 × 950)
	Air filter		Resin net (with mold resistance)	Resin net (with mold resistance)
	Weight	lbs (kg)	12 (5.5) / 22 (10.0)	12 (5.5) / 22 (10.0)
Outdoor unit			RZQ18TBVJUA	RZQ24TBVJUA
Casing color			Ivory white	Ivory white
Dimensions: (H×W×D)		in (mm)	39 × 37 × 12-5/8 (990 × 940 × 320)	39 × 37 × 12-5/8 (990 × 940 × 320)
Coil	Type		Cross fin coil	Cross fin coil
Compressor	Type		Hermetically sealed swing type	Hermetically sealed swing type
	Motor output	kW	1.9	1.9
Fan	Type		Propeller fan	Propeller fan
	Motor output	W	200	200
	Airflow rate	cfm (m ³ /min)	2,682 (76)	2,682 (76)
Weight		lbs (kg)	172 (78)	172 (78)
Sound pressure level (Cooling/Heating)			58 / 61	58 / 61
Connecting Pipes	Liquid Pipe	in (mm)	φ3/8 (φ9.5) (Flare connection)	φ3/8 (φ9.5) (Flare connection)
	Gas Pipe	in (mm)	φ5/8 (φ15.9) (Flare connection)	φ5/8 (φ15.9) (Flare connection)
	Drain Pipe	in (mm)	φ1 (φ26) (Hole)	φ1 (φ26) (Hole)
Safety devices			High pressure switch, Outdoor fan driver overload protector, Inverter overload protector, Fusible plug, Fuse	High pressure switch, Outdoor fan driver overload protector, Inverter overload protector, Fusible plug, Fuse
Capacity step		%	14-100	14-100
Refrigerant control			Electronic expansion valve	Electronic expansion valve
Ref. piping	Standard length	ft (m)	25 (7.6)	25 (7.6)
	Max. length	ft (m)	164 (50)	164 (50)
	Max. height difference	ft (m)	98 (30)	98 (30)
Refrigerant	Type		R-410A	R-410A
	Charge	lbs (kg)	6.4 (2.9)	6.4 (2.9)
Ref. oil	Type		DAPHNE FVC50K	DAPHNE FVC50K
	Charge	L	1.08	1.08
Drawing No.	Specification		4D143001B	4D143001B
	Sound (indoor)		4D140998	4D140998
	Sound (outdoor)		4D101947D / 4D101948E	4D101947D / 4D101948E

Notes:

- ★1 Indoor temp.: 80°FDB (26.7°CDB), 67°FWB (19.4°CWB) / Outdoor temp.: 95°FDB (35.0°CDB) / Equivalent piping length: 25 ft (7.6 m), height difference: 0 ft (0 m).
- ★2 Indoor temp.: 70°FDB (21.1°CDB) / Outdoor temp.: 47°FDB (8.3°CDB), 43°FWB (6.1°CWB) / Equivalent piping length: 25 ft (7.6 m), height difference: 0 ft (0 m).
- ★3 Indoor temp.: 70°FDB (21.1°CDB) / Outdoor temp.: 17°FDB (-8.3°CDB), 15°FWB (-9.4°CWB) / Equivalent piping length: 25 ft (7.6 m), height difference: 0 ft (0 m).
- ★4 Capacities are net, including a deduction for cooling (an addition for heating) for indoor fan motor heat.

Model name		Indoor unit	FCQ30AAVJU	FCQ36AAVJU
		Outdoor unit	RZQ30TBVJUA	RZQ36TBVJUA
Power supply			1 phase, 208/230 V, 60 Hz	1 phase, 208/230 V, 60 Hz
★1 ★4 Cooling capacity	Btu/h (kW)		30,000 (8.8)	36,000 (10.6)
★2 ★4 Heating capacity	Btu/h (kW)		34,000 (10.0)	40,000 (11.7)
★3 ★4 Heating capacity	Btu/h (kW)		22,800 (6.7)	26,200 (7.7)
Indoor unit			FCQ30AAVJU	FCQ36AAVJU
Casing color			Galvanized steel plate	Galvanized steel plate
Dimensions: (H×W×D)		in (mm)	11-11/32 × 33-1/16 × 33-1/16 (288 × 840 × 840)	11-11/32 × 33-1/16 × 33-1/16 (288 × 840 × 840)
Coil	Type		Cross fin coil	Cross fin coil
Fan	Type		Turbo fan	Turbo fan
	Motor output	W	106	106
	Airflow rate (H/M/L)	cfm (m ³ /min)	1,059/882/671 (30.0/25.0/19.0)	1,253/918/671 (35.5/26.0/19.0)
Sound pressure level (H/M/L)		dB(A)	42.0/37.0/32.0	47.0/38.0/32.0
Air filter			—	—
Weight		lbs (kg)	58 (26)	58 (26)
Connecting Pipes	Liquid Pipe	in (mm)	φ3/8 (φ9.5) (Flare connection)	φ3/8 (φ9.5) (Flare connection)
	Gas Pipe	in (mm)	φ5/8 (φ15.9) (Flare connection)	φ5/8 (φ15.9) (Flare connection)
	Drain Pipe	in (mm)	VP25 (External dia. 1-1/4 (32), internal dia. 1 (26))	VP25 (External dia. 1-1/4 (32), internal dia. 1 (26))
Remote controller (accessory)	Wired		BRC1E73, BRC1H71W	BRC1E73, BRC1H71W
	Wireless		—	—
Decoration panels (accessory)	Model		BYCQ54EEFU / BYCQ54EEGFU	BYCQ54EEFU / BYCQ54EEGFU
	Color		Fresh white	Fresh white
	Dimensions: (H×W×D)	in (mm)	2 × 37-3/8 × 37-3/8 / 5-1/8 × 37-3/8 × 37-3/8 (50 × 950 × 950 / 130 × 950 × 950)	2 × 37-3/8 × 37-3/8 / 5-1/8 × 37-3/8 × 37-3/8 (50 × 950 × 950 / 130 × 950 × 950)
	Air filter		Resin net (with mold resistance)	Resin net (with mold resistance)
	Weight	lbs (kg)	12 (5.5) / 22 (10.0)	12 (5.5) / 22 (10.0)
Outdoor unit			RZQ30TBVJUA	RZQ36TBVJUA
Casing color			Ivory white	Ivory white
Dimensions: (H×W×D)		in (mm)	52-15/16 × 35-7/16 × 12-5/8 (1,345 × 900 × 320)	52-15/16 × 35-7/16 × 12-5/8 (1,345 × 900 × 320)
Coil	Type		Cross fin coil	Cross fin coil
Compressor	Type		Hermetically sealed swing type	Hermetically sealed swing type
	Motor output	kW	3.5	3.5
Fan	Type		Propeller fan	Propeller fan
	Motor output	W	70 × 2	70 × 2
	Airflow rate	cfm (m ³ /min)	3,741 (106)	3,741 (106)
Weight		lbs (kg)	225 (102)	225 (102)
Sound pressure level (Cooling/Heating)		dB(A)	57 / 59	57 / 59
Connecting Pipes	Liquid Pipe	in (mm)	φ3/8 (φ9.5) (Flare connection)	φ3/8 (φ9.5) (Flare connection)
	Gas Pipe	in (mm)	φ5/8 (φ15.9) (Flare connection)	φ5/8 (φ15.9) (Flare connection)
	Drain Pipe	in (mm)	φ1 (φ26) (Hole)	φ1 (φ26) (Hole)
Safety devices			High pressure switch, Outdoor fan driver overload protector, Inverter overload protector, Fusible plug, Fuse	High pressure switch, Outdoor fan driver overload protector, Inverter overload protector, Fusible plug, Fuse
Capacity step		%	14-100	14-100
Refrigerant control			Electronic expansion valve	Electronic expansion valve
Ref. piping	Standard length	ft (m)	25 (7.6)	25 (7.6)
	Max. length	ft (m)	230 (70)	230 (70)
	Max. height difference	ft (m)	98 (30)	98 (30)
Refrigerant	Type		R-410A	R-410A
	Charge	lbs (kg)	7.9 (3.6)	7.9 (3.6)
Ref. oil	Type		DAPHNE FVC50K	DAPHNE FVC50K
	Charge	L	1.52	1.52
Drawing No.	Specification		4D143002B	4D143002B
	Sound (indoor)		4D140999	4D141000
	Sound (outdoor)		4D101949D / 4D101950E	4D101949D / 4D101950E

Notes:

- ★1 Indoor temp.: 80°FDB (26.7°CDB), 67°FWB (19.4°CWB) / Outdoor temp.: 95°FDB (35.0°CDB) / Equivalent piping length: 25 ft (7.6 m), height difference: 0 ft (0 m).
★2 Indoor temp.: 70°FDB (21.1°CDB) / Outdoor temp.: 47°FDB (8.3°CDB), 43°FWB (6.1°CWB) / Equivalent piping length: 25 ft (7.6 m), height difference: 0 ft (0 m).
★3 Indoor temp.: 70°FDB (21.1°CDB) / Outdoor temp.: 17°FDB (-8.3°CDB), 15°FWB (-9.4°CWB) / Equivalent piping length: 25 ft (7.6 m), height difference: 0 ft (0 m).
★4 Capacities are net, including a deduction for cooling (an addition for heating) for indoor fan motor heat.

Model name		Indoor unit	FCQ42AAVJU	FCQ48AAVJU
		Outdoor unit	RZQ42TBVJUA	RZQ48TBVJUA
Power supply			1 phase, 208/230 V, 60 Hz	1 phase, 208/230 V, 60 Hz
★1 ★4 Cooling capacity	Btu/h (kW)		42,000 (12.3)	48,000 (14.1)
★2 ★4 Heating capacity	Btu/h (kW)		47,000 (13.8)	54,000 (15.8)
★3 ★4 Heating capacity	Btu/h (kW)		31,200 (9.1)	34,800 (10.2)
Indoor unit			FCQ42AAVJU	FCQ48AAVJU
Casing color			Galvanized steel plate	Galvanized steel plate
Dimensions: (H×W×D)		in (mm)	11-11/32 × 33-1/16 × 33-1/16 (288 × 840 × 840)	11-11/32 × 33-1/16 × 33-1/16 (288 × 840 × 840)
Coil	Type		Cross fin coil	Cross fin coil
Fan	Type		Turbo fan	Turbo fan
	Motor output	W	106	106
	Airflow rate (H/M/L)	cfm (m ³ /min)	1,253/971/741 (35.5/27.5/21.0)	1,253/971/741 (35.5/27.5/21.0)
Sound pressure level (H/M/L)		dB(A)	47.0/40.0/35.0	47.0/40.0/35.0
Air filter			—	—
Weight		lbs (kg)	58 (26)	58 (26)
Connecting Pipes	Liquid Pipe	in (mm)	φ3/8 (φ9.5) (Flare connection)	φ3/8 (φ9.5) (Flare connection)
	Gas Pipe	in (mm)	φ5/8 (φ15.9) (Flare connection)	φ5/8 (φ15.9) (Flare connection)
	Drain Pipe	in (mm)	VP25 (External dia. 1-1/4 (32), internal dia. 1 (26))	VP25 (External dia. 1-1/4 (32), internal dia. 1 (26))
Remote controller (accessory)	Wired		BRC1E73, BRC1H71W	BRC1E73, BRC1H71W
	Wireless		—	—
Decoration panels (accessory)	Model		BYCQ54EEFU / BYCQ54EEGJU	BYCQ54EEFU / BYCQ54EEGJU
	Color		Fresh white	Fresh white
	Dimensions: (H×W×D)	in (mm)	2 × 37-3/8 × 37-3/8 / 5-1/8 × 37-3/8 × 37-3/8 (50 × 950 × 950 / 130 × 950 × 950)	2 × 37-3/8 × 37-3/8 / 5-1/8 × 37-3/8 × 37-3/8 (50 × 950 × 950 / 130 × 950 × 950)
	Air filter		Resin net (with mold resistance)	Resin net (with mold resistance)
	Weight	lbs (kg)	12 (5.5) / 22 (10.0)	12 (5.5) / 22 (10.0)
Outdoor unit			RZQ42TBVJUA	RZQ48TBVJUA
Casing color			Ivory white	Ivory white
Dimensions: (H×W×D)		in (mm)	52-15/16 × 35-7/16 × 12-5/8 (1,345 × 900 × 320)	52-15/16 × 35-7/16 × 12-5/8 (1,345 × 900 × 320)
Coil	Type		Cross fin coil	Cross fin coil
Compressor	Type		Hermetically sealed swing type	Hermetically sealed swing type
	Motor output	kW	3.5	3.5
Fan	Type		Propeller fan	Propeller fan
	Motor output	W	70 × 2	70 × 2
	Airflow rate	cfm (m ³ /min)	3,741 (106)	3,741 (106)
Weight		lbs (kg)	225 (102)	225 (102)
Sound pressure level (Cooling/Heating)		dB(A)	57 / 59	57 / 59
Connecting Pipes	Liquid Pipe	in (mm)	φ3/8 (φ9.5) (Flare connection)	φ3/8 (φ9.5) (Flare connection)
	Gas Pipe	in (mm)	φ5/8 (φ15.9) (Flare connection)	φ5/8 (φ15.9) (Flare connection)
	Drain Pipe	in (mm)	φ1 (φ26) (Hole)	φ1 (φ26) (Hole)
Safety devices			High pressure switch, Outdoor fan driver overload protector, Inverter overload protector, Fusible plug, Fuse	High pressure switch, Outdoor fan driver overload protector, Inverter overload protector, Fusible plug, Fuse
Capacity step		%	14-100	14-100
Refrigerant control			Electronic expansion valve	Electronic expansion valve
Ref. piping	Standard length	ft (m)	25 (7.6)	25 (7.6)
	Max. length	ft (m)	230 (70)	230 (70)
	Max. height difference	ft (m)	98 (30)	98 (30)
Refrigerant	Type		R-410A	R-410A
	Charge	lbs (kg)	7.9 (3.6)	7.9 (3.6)
Ref. oil	Type		DAPHNE FVC50K	DAPHNE FVC50K
	Charge	L	1.52	1.52
Drawing No.	Specification		4D143002B	4D143002B
	Sound (indoor)		4D141001	4D141001
	Sound (outdoor)		4D101949D / 4D101950E	4D101949D / 4D101950E

Notes:

- ★1 Indoor temp.: 80°FDB (26.7°CDB), 67°FWB (19.4°CWB) / Outdoor temp.: 95°FDB (35.0°CDB) / Equivalent piping length: 25 ft (7.6 m), height difference: 0 ft (0 m).
- ★2 Indoor temp.: 70°FDB (21.1°CDB) / Outdoor temp.: 47°FDB (8.3°CDB), 43°FWB (6.1°CWB) / Equivalent piping length: 25 ft (7.6 m), height difference: 0 ft (0 m).
- ★3 Indoor temp.: 70°FDB (21.1°CDB) / Outdoor temp.: 17°FDB (-8.3°CDB), 15°FWB (-9.4°CWB) / Equivalent piping length: 25 ft (7.6 m), height difference: 0 ft (0 m).
- ★4 Capacities are net, including a deduction for cooling (an addition for heating) for indoor fan motor heat.

3.2.2 Ceiling Suspended Type

Model name	Indoor unit		FHQ18PVJU	FHQ24PVJU
	Outdoor unit		RZQ18TAVJU	RZQ24TAVJU
Power supply			1 phase, 208/230 V, 60 Hz	1 phase, 208/230 V, 60 Hz
★1 ★4 Cooling capacity	Btu/h (kW)		18,000 (5.3)	24,000 (7.0)
★2 ★4 Heating capacity	Btu/h (kW)		20,000 (5.9)	27,000 (7.9)
★3 ★4 Heating capacity	Btu/h (kW)		12,000 (3.5)	18,000 (5.3)
SEER (Rated)			16.3	16.6
EER (Rated)	Btu/h-W		12.9	11.3
HSPF (Rated)			9.1	9.3
Indoor unit			FHQ18PVJU	FHQ24PVJU
Casing color			White (10Y9/0.5)	White (10Y9/0.5)
Dimensions: (H×W×D)	in (mm)		7-11/16 × 62-5/8 × 26-3/4 (195 × 1,590 × 680)	7-11/16 × 62-5/8 × 26-3/4 (195 × 1,590 × 680)
Coil	Type		Cross fin coil	Cross fin coil
	Rows×Stages×FPI		2 × 12 × 15 + 2 × 10 × 15	2 × 12 × 15 + 2 × 10 × 15
	Face area	ft ² (m ²)	3.66 (0.34) + 2.95 (0.27)	3.66 (0.34) + 2.95 (0.27)
Fan	Model		—	—
	Type		Sirocco fan	Sirocco fan
	Motor output	W	130	130
	Airflow rate (H/L)	cfm (m ³ /min)	790/670 (22.4/19.0)	790/670 (22.4/19.0)
Air filter			Resin net (with mold resistance)	Resin net (with mold resistance)
Weight	lbs (kg)		90 (19.8)	90 (19.8)
Connecting Pipes	Liquid Pipe	in (mm)	φ3/8 (φ9.5) (Flare connection)	φ3/8 (φ9.5) (Flare connection)
	Gas Pipe	in (mm)	φ5/8 (φ15.9) (Flare connection)	φ5/8 (φ15.9) (Flare connection)
	Drain Pipe	in (mm)	VP20 (External dia. 1 (26), internal dia. 3/4 (19.1))	VP20 (External dia. 1 (26), internal dia. 3/4 (19.1))
Remote controller (option)	Wired		BRC1E73	BRC1E73
	Wireless		BRC7E83	BRC7E83
Outdoor unit			RZQ18TAVJU	RZQ24TAVJU
Casing color			Ivory white	Ivory white
Dimensions: (H×W×D)	in (mm)		39 × 37 × 12-5/8 (990 × 940 × 320)	39 × 37 × 12-5/8 (990 × 940 × 320)
Coil	Type		Cross fin coil	Cross fin coil
	Rows×Stages×FPI		2 × 44 × 19	2 × 44 × 19
	Face area	ft ² (m ²)	9.5 (0.88)	9.5 (0.88)
Compressor	Model		2YC63ABXDD	2YC63ABXDD
	Type		Hermetically sealed swing type	Hermetically sealed swing type
	Motor output	kW	1.9	1.9
Fan	Model		P51J11F	P51J11F
	Type		Propeller fan	Propeller fan
	Motor output	W	200	200
	Airflow rate	cfm (m ³ /min)	2,682 (76)	2,682 (76)
Weight	lbs (kg)		172 (78)	172 (78)
Sound pressure level (Cooling/Heating)	dB(A)		58 / 61	58 / 61
Connecting Pipes	Liquid Pipe	in (mm)	φ3/8 (φ9.5) (Flare connection)	φ3/8 (φ9.5) (Flare connection)
	Gas Pipe	in (mm)	φ5/8 (φ15.9) (Flare connection)	φ5/8 (φ15.9) (Flare connection)
	Drain Pipe	in (mm)	φ1 (φ26) (Hole)	φ1 (φ26) (Hole)
Safety devices			High pressure switch, Outdoor fan driver overload protector, Inverter overload protector, Fusible plugs, Fuse	High pressure switch, Outdoor fan driver overload protector, Inverter overload protector, Fusible plugs, Fuse
Capacity Control	%		14-100	14-100
Refrigerant control			Electronic expansion valve	Electronic expansion valve
Ref. piping	Standard length	ft (m)	25 (7.6)	25 (7.6)
	Max. length	ft (m)	164 (50)	164 (50)
	Max. height difference	ft (m)	98 (30)	98 (30)
Refrigerant	Model		R-410A	R-410A
	Charge	lbs (kg)	6.4 (2.9)	6.4 (2.9)
Ref. oil	Model		DAPHNE FVC50K	DAPHNE FVC50K
	Charge	L	1.08	1.08
Drawing No.	Specification		C: 4D115557A	C: 4D115557A
	Sound (outdoor)		C: 4D101947D / C: 4D101948E	C: 4D101947D / C: 4D101948E
Notes:				
★1 Indoor temp.: 80°FDB (26.7°CDB), 67°FWB (19.4°CWB) / Outdoor temp.: 95°FDB (35.0°CDB) / Equivalent piping length: 25 ft (7.6 m), level difference: 0 ft (0 m).				
★2 Indoor temp.: 70°FDB (21.1°CDB) / Outdoor temp.: 47°FDB (8.3°CDB), 43°FWB (6.1°CWB) / Equivalent piping length: 25 ft (7.6 m), level difference: 0 ft (0 m).				
★3 Indoor temp.: 70°FDB (21.1°CDB) / Outdoor temp.: 17°FDB (-8.3°CDB), 15°FWB (-9.4°CWB) / Equivalent piping length: 25 ft (7.6 m), level difference: 0 ft (0 m).				
★4 Capacities are net, including a deduction for cooling (an addition for heating) for indoor fan motor heat.				

Model name		Indoor unit	FHQ30PVJU	FHQ36MVJU
		Outdoor unit	RZQ30TAVJU	RZQ36TAVJU
Power supply			1 phase, 208/230 V, 60 Hz	1 phase, 208/230 V, 60 Hz
★1 ★4 Cooling capacity	Btu/h (kW)		30,000 (8.8)	36,000 (10.6)
★2 ★4 Heating capacity	Btu/h (kW)		34,000 (10.0)	40,000 (11.7)
★3 ★4 Heating capacity	Btu/h (kW)		24,000 (7.0)	22,000 (6.4)
SEER (Rated)			16.0	14.0
EER (Rated)		Btu/h-W	10.5	9.5
HSPF (Rated)			8.4	8.2
Indoor unit			FHQ30PVJU	FHQ36MVJU
Casing color			White (10Y9/0.5)	White (10Y9/0.5)
Dimensions: (H×W×D)		in (mm)	7-11/16 × 62-5/8 × 26-3/4 (195 × 1,590 × 680)	7-11/16 × 62-5/8 × 26-3/4 (195 × 1,590 × 680)
Coil	Type		Cross fin coil	Cross fin coil
	Rows×Stages×FPI		2 × 12 × 15 + 2 × 10 × 15	2 × 12 × 15 + 2 × 10 × 15
	Face area	ft ² (m ²)	3.66 (0.34) + 2.95 (0.27)	3.66 (0.34) + 2.95 (0.27)
Fan	Model		—	—
	Type		Sirocco fan	Sirocco fan
	Motor output	W	130	130
	Airflow rate (H/L)	cfm (m ³ /min)	790/670 (22.4/19.0)	830/670 (23.5/19.0)
Air filter			Resin net (with mold resistance)	Resin net (with mold resistance)
Weight		lbs (kg)	90 (19.8)	90 (19.8)
Connecting Pipes	Liquid Pipe	in (mm)	φ3/8 (φ9.5) (Flare connection)	φ3/8 (φ9.5) (Flare connection)
	Gas Pipe	in (mm)	φ5/8 (φ15.9) (Flare connection)	φ5/8 (φ15.9) (Flare connection)
	Drain Pipe	in (mm)	VP20 (External dia. 1 (26), internal dia. 3/4 (19.1))	VP20 (External dia. 1 (26), internal dia. 3/4 (19.1))
Remote controller (option)	Wired		BRC1E73	BRC1E73
	Wireless		BRC7E83	BRC7E83
Outdoor unit			RZQ30TAVJU	RZQ36TAVJU
Casing color			Ivory white	Ivory white
Dimensions: (H×W×D)		in (mm)	52-15/16 × 35-7/16 × 12-5/8 (1,345 × 900 × 320)	52-15/16 × 35-7/16 × 12-5/8 (1,345 × 900 × 320)
Coil	Type		Cross fin coil	Cross fin coil
	Rows×Stages×FPI		2 × 60 × 19	2 × 60 × 19
	Face area	ft ² (m ²)	12.2 (1.134)	12.2 (1.134)
Compressor	Model		2YC90GXD#D	2YC90GXD#D
	Type		Hermetically sealed swing type	Hermetically sealed swing type
	Motor output	kW	3.5	3.5
Fan	Model		P47N	P47N
	Type		Propeller fan	Propeller fan
	Motor output	W	70 × 2	70 × 2
	Airflow rate	cfm (m ³ /min)	3,741 (106)	3,741 (106)
Weight		lbs (kg)	225 (102)	225 (102)
Sound pressure level (Cooling/Heating)		dB(A)	57 / 59	57 / 59
Connecting Pipes	Liquid Pipe	in (mm)	φ3/8 (φ9.5) (Flare connection)	φ3/8 (φ9.5) (Flare connection)
	Gas Pipe	in (mm)	φ5/8 (φ15.9) (Flare connection)	φ5/8 (φ15.9) (Flare connection)
	Drain Pipe	in (mm)	φ1 (φ26) (Hole)	φ1 (φ26) (Hole)
Safety devices			High pressure switch, Outdoor fan driver overload protector, Inverter overload protector, Fusible plugs, Fuse	High pressure switch, Outdoor fan driver overload protector, Inverter overload protector, Fusible plugs, Fuse
Capacity Control		%	14-100	14-100
Refrigerant control			Electronic expansion valve	Electronic expansion valve
Ref. piping	Standard length	ft (m)	25 (7.6)	25 (7.6)
	Max. length	ft (m)	230 (70)	230 (70)
	Max. height difference	ft (m)	98 (30)	98 (30)
Refrigerant	Model		R-410A	R-410A
	Charge	lbs (kg)	7.9 (3.6)	7.9 (3.6)
Ref. oil	Model		DAPHNE FVC50K	DAPHNE FVC50K
	Charge	L	1.52	1.52
Drawing No.	Specification		C: 4D115559B	C: 4D115559B
	Sound (outdoor)		C: 4D101949D / C: 4D101950E	C: 4D101949D / C: 4D101950E

Notes:
★1 Indoor temp.: 80°FDB (26.7°CDB), 67°FWB (19.4°CWB) / Outdoor temp.: 95°FDB (35.0°CDB) / Equivalent piping length: 25 ft (7.6 m), level difference: 0 ft (0 m).
★2 Indoor temp.: 70°FDB (21.1°CDB) / Outdoor temp.: 47°FDB (8.3°CDB), 43°FWB (6.1°CWB) / Equivalent piping length: 25 ft (7.6 m), level difference: 0 ft (0 m).
★3 Indoor temp.: 70°FDB (21.1°CDB) / Outdoor temp.: 17°FDB (-8.3°CDB), 15°FWB (-9.4°CWB) / Equivalent piping length: 25 ft (7.6 m), level difference: 0 ft (0 m).
★4 Capacities are net, including a deduction for cooling (an addition for heating) for indoor fan motor heat.

Model name	Indoor unit	FHQ42MVJU	
	Outdoor unit	RZQ42TAVJU	
Power supply		1 phase, 208/230 V, 60 Hz	
★1 ★4 Cooling capacity	Btu/h (kW)	40,500 (11.9)	
★2 ★4 Heating capacity	Btu/h (kW)	40,000 (11.7)	
★3 ★4 Heating capacity	Btu/h (kW)	23,400 (6.9)	
SEER (Rated)		14.0	
EER (Rated)		8.8	
HSPF (Rated)		8.2	
Indoor unit		FHQ42MVJU	
Casing color		White (10Y9/0.5)	
Dimensions: (H×W×D)		7-11/16 × 62-5/8 × 26-3/4 (195 × 1,590 × 680)	
Coil	Type	Cross fin coil	
	Rows×Stages×FPI	2 × 12 × 15 + 2 × 10 × 15	
	Face area	3.66 (0.34) + 2.95 (0.27)	
Fan	Model	—	
	Type	Sirocco fan	
	Motor output	W	
	Airflow rate (H/L)	cfm (m ³ /min)	
Air filter		Resin net (with mold resistance)	
Weight		lbs (kg)	
Connecting Pipes	Liquid Pipe	in (mm)	
	Gas Pipe	in (mm)	
	Drain Pipe	in (mm)	
Remote controller (option)	Wired	BRC1E73	
	Wireless	BRC7E83	
Outdoor unit		RZQ42TAVJU	
Casing color		Ivory white	
Dimensions: (H×W×D)		52-15/16 × 35-7/16 × 12-5/8 (1,345 × 900 × 320)	
Coil	Type	Cross fin coil	
	Rows×Stages×FPI	2 × 60 × 19	
	Face area	12.2 (1.134)	
Compressor	Model	2YC90GXD#D	
	Type	Hermetically sealed swing type	
	Motor output	kW	
Fan	Model	P47N	
	Type	Propeller fan	
	Motor output	W	
	Airflow rate	cfm (m ³ /min)	
Weight		lbs (kg)	
Sound pressure level (Cooling/Heating)		dB(A)	
Connecting Pipes	Liquid Pipe	in (mm)	
	Gas Pipe	in (mm)	
	Drain Pipe	in (mm)	
Safety devices		High pressure switch, Outdoor fan driver overload protector, Inverter overload protector, Fusible plugs, Fuse	
Capacity Control		%	
Refrigerant control		Electronic expansion valve	
Ref. piping	Standard length	ft (m)	
	Max. length	ft (m)	
	Max. height difference	ft (m)	
Refrigerant	Model	R-410A	
	Charge	lbs (kg)	
Ref. oil	Model	DAPHNE FVC50K	
	Charge	L	
Drawing No.	Specification	C: 4D115559B	
	Sound (outdoor)	C: 4D101949D / C: 4D101950E	
Notes:			
★1 Indoor temp.: 80°FDB (26.7°CDB), 67°FWB (19.4°CWB) / Outdoor temp.: 95°FDB (35.0°CDB) / Equivalent piping length: 25 ft (7.6 m), level difference: 0 ft (0 m)			
★2 Indoor temp.: 70°FDB (21.1°CDB) / Outdoor temp.: 47°FDB (8.3°CDB), 43°FWB (6.1°CWB) / Equivalent piping length: 25 ft (7.6 m), level difference: 0 ft (0 m).			
★3 Indoor temp.: 70°FDB (21.1°CDB) / Outdoor temp.: 17°FDB (-8.3°CDB), 15°FWB (-9.4°CWB) / Equivalent piping length: 25 ft (7.6 m), level difference: 0 ft (0 m).			
★4 Capacities are net, including a deduction for cooling (an addition for heating) for indoor fan motor heat			

Model name		Indoor unit	FHQ18PVJU	FHQ24PVJU
		Outdoor unit	RZQ18TAVJUA	RZQ24TAVJUA
Power supply			1 phase, 208/230 V, 60 Hz	1 phase, 208/230 V, 60 Hz
★1 ★4 Cooling capacity	Btu/h (kW)		18,000 (5.3)	24,000 (7.0)
★2 ★4 Heating capacity	Btu/h (kW)		20,000 (5.9)	27,000 (7.9)
★3 ★4 Heating capacity	Btu/h (kW)		12,000 (3.5)	18,000 (5.3)
SEER (Rated)			16.3	16.6
EER (Rated)		Btu/h·W	12.9	11.3
HSPF (Rated)			9.1	9.3
Indoor unit			FHQ18PVJU	FHQ24PVJU
Casing color			White (10Y9/0.5)	White (10Y9/0.5)
Dimensions: (H×W×D)		in (mm)	7-11/16 × 62-5/8 × 26-3/4 (195 × 1,590 × 680)	7-11/16 × 62-5/8 × 26-3/4 (195 × 1,590 × 680)
Coil	Type		Cross fin coil	Cross fin coil
	Rows×Stages×FPI		2 × 12 × 15 + 2 × 10 × 15	2 × 12 × 15 + 2 × 10 × 15
	Face area	ft ² (m ²)	3.66 (0.34) + 2.95 (0.27)	3.66 (0.34) + 2.95 (0.27)
Fan	Model		—	—
	Type		Sirocco fan	Sirocco fan
	Motor output	W	130	130
	Airflow rate (H/L)	cfm (m ³ /min)	790/670 (22.4/19.0)	790/670 (22.4/19.0)
Air filter			Resin net (with mold resistance)	Resin net (with mold resistance)
Weight		lbs (kg)	90 (19.8)	90 (19.8)
Connecting Pipes	Liquid Pipe	in (mm)	φ3/8 (φ9.5) (Flare connection)	φ3/8 (φ9.5) (Flare connection)
	Gas Pipe	in (mm)	φ5/8 (φ15.9) (Flare connection)	φ5/8 (φ15.9) (Flare connection)
	Drain Pipe	in (mm)	VP20 (External dia. 1 (26), internal dia. 3/4 (19.1))	VP20 (External dia. 1 (26), internal dia. 3/4 (19.1))
Remote controller (option)	Wired		BRC1E73	BRC1E73
	Wireless		BRC7E83	BRC7E83
Outdoor unit			RZQ18TAVJUA	RZQ24TAVJUA
Casing color			Ivory white	Ivory white
Dimensions: (H×W×D)		in (mm)	39 × 37 × 12-5/8 (990 × 940 × 320)	39 × 37 × 12-5/8 (990 × 940 × 320)
Coil	Type		Cross fin coil	Cross fin coil
	Rows×Stages×FPI		2 × 44 × 19	2 × 44 × 19
	Face area	ft ² (m ²)	9.5 (0.88)	9.5 (0.88)
Compressor	Model		2YC63TXD#A	2YC63TXD#A
	Type		Hermetically sealed swing type	Hermetically sealed swing type
	Motor output	kW	1.9	1.9
Fan	Model		P51J11F	P51J11F
	Type		Propeller fan	Propeller fan
	Motor output	W	200	200
	Airflow rate	cfm (m ³ /min)	2,682 (76)	2,682 (76)
Weight		lbs (kg)	172 (78)	172 (78)
Sound pressure level (Cooling/Heating)		dB(A)	58 / 61	58 / 61
Connecting Pipes	Liquid Pipe	in (mm)	φ3/8 (φ9.5) (Flare connection)	φ3/8 (φ9.5) (Flare connection)
	Gas Pipe	in (mm)	φ5/8 (φ15.9) (Flare connection)	φ5/8 (φ15.9) (Flare connection)
	Drain Pipe	in (mm)	φ1 (φ26) (Hole)	φ1 (φ26) (Hole)
Safety devices			High pressure switch, Outdoor fan driver overload protector, Inverter overload protector, Fusible plugs, Fuse	High pressure switch, Outdoor fan driver overload protector, Inverter overload protector, Fusible plugs, Fuse
Capacity Control		%	14-100	14-100
Refrigerant control			Electronic expansion valve	Electronic expansion valve
Ref. piping	Standard length	ft (m)	25 (7.6)	25 (7.6)
	Max. length	ft (m)	164 (50)	164 (50)
	Max. height difference	ft (m)	98 (30)	98 (30)
Refrigerant	Model		R-410A	R-410A
	Charge	lbs (kg)	6.4 (2.9)	6.4 (2.9)
Ref. oil	Model		DAPHNE FVC50K	DAPHNE FVC50K
	Charge	L	1.08	1.08
Drawing No.	Specification		C: 4D126354	C: 4D126354
	Sound (outdoor)		C: 4D101947D / C: 4D101948E	C: 4D101947D / C: 4D101948E

Notes:

- ★1 Indoor temp.: 80°FDB (26.7°CDB), 67°FWB (19.4°CWB) / Outdoor temp.: 95°FDB (35.0°CDB) / Equivalent piping length: 25 ft (7.6 m), level difference: 0 ft (0 m).
- ★2 Indoor temp.: 70°FDB (21.1°CDB) / Outdoor temp.: 47°FDB (8.3°CDB), 43°FWB (6.1°CWB) / Equivalent piping length: 25 ft (7.6 m), level difference: 0 ft (0 m).
- ★3 Indoor temp.: 70°FDB (21.1°CDB) / Outdoor temp.: 17°FDB (-8.3°CDB), 15°FWB (-9.4°CWB) / Equivalent piping length: 25 ft (7.6 m), level difference: 0 ft (0 m).
- ★4 Capacities are net, including a deduction for cooling (an addition for heating) for indoor fan motor heat.

Model name		Indoor unit	FHQ30PVJU	FHQ36MVJU
		Outdoor unit	RZQ30TAVJUA	RZQ36TAVJUA
Power supply			1 phase, 208/230 V, 60 Hz	1 phase, 208/230 V, 60 Hz
★1 ★4 Cooling capacity	Btu/h (kW)		30,000 (8.8)	36,000 (10.6)
★2 ★4 Heating capacity	Btu/h (kW)		34,000 (10.0)	40,000 (11.7)
★3 ★4 Heating capacity	Btu/h (kW)		24,000 (7.0)	22,000 (6.4)
SEER (Rated)			16.0	14.0
EER (Rated)		Btu/h-W	10.5	9.5
HSPF (Rated)			8.4	8.2
Indoor unit			FHQ30PVJU	FHQ36MVJU
Casing color			White (10Y9/0.5)	White (10Y9/0.5)
Dimensions: (H×W×D)		in (mm)	7-11/16 × 62-5/8 × 26-3/4 (195 × 1,590 × 680)	7-11/16 × 62-5/8 × 26-3/4 (195 × 1,590 × 680)
Coil	Type		Cross fin coil	Cross fin coil
	Rows×Stages×FPI		2 × 12 × 15 + 2 × 10 × 15	2 × 12 × 15 + 2 × 10 × 15
	Face area	ft ² (m ²)	3.66 (0.34) + 2.95 (0.27)	3.66 (0.34) + 2.95 (0.27)
Fan	Model		—	—
	Type		Sirocco fan	Sirocco fan
	Motor output	W	130	130
	Airflow rate (H/L)	cfm (m ³ /min)	790/670 (22.4/19.0)	830/670 (23.5/19.0)
Air filter			Resin net (with mold resistance)	Resin net (with mold resistance)
Weight		lbs (kg)	90 (19.8)	90 (19.8)
Connecting Pipes	Liquid Pipe	in (mm)	φ3/8 (φ9.5) (Flare connection)	φ3/8 (φ9.5) (Flare connection)
	Gas Pipe	in (mm)	φ5/8 (φ15.9) (Flare connection)	φ5/8 (φ15.9) (Flare connection)
	Drain Pipe	in (mm)	VP20 (External dia. 1 (26), internal dia. 3/4 (19.1))	VP20 (External dia. 1 (26), internal dia. 3/4 (19.1))
Remote controller (option)	Wired		BRC1E73	BRC1E73
	Wireless		BRC7E83	BRC7E83
Outdoor unit			RZQ30TAVJUA	RZQ36TAVJUA
Casing color			Ivory white	Ivory white
Dimensions: (H×W×D)		in (mm)	52-15/16 × 35-7/16 × 12-5/8 (1,345 × 900 × 320)	52-15/16 × 35-7/16 × 12-5/8 (1,345 × 900 × 320)
Coil	Type		Cross fin coil	Cross fin coil
	Rows×Stages×FPI		2 × 60 × 19	2 × 60 × 19
	Face area	ft ² (m ²)	12.2 (1.134)	12.2 (1.134)
Compressor	Model		2YC90FXD#A	2YC90FXD#A
	Type		Hermetically sealed swing type	Hermetically sealed swing type
	Motor output	kW	3.5	3.5
Fan	Model		P47N	P47N
	Type		Propeller fan	Propeller fan
	Motor output	W	70 × 2	70 × 2
	Airflow rate	cfm (m ³ /min)	3,741 (106)	3,741 (106)
Weight		lbs (kg)	225 (102)	225 (102)
Sound pressure level (Cooling/Heating)		dB(A)	57 / 59	57 / 59
Connecting Pipes	Liquid Pipe	in (mm)	φ3/8 (φ9.5) (Flare connection)	φ3/8 (φ9.5) (Flare connection)
	Gas Pipe	in (mm)	φ5/8 (φ15.9) (Flare connection)	φ5/8 (φ15.9) (Flare connection)
	Drain Pipe	in (mm)	φ1 (φ26) (Hole)	φ1 (φ26) (Hole)
Safety devices			High pressure switch, Outdoor fan driver overload protector, Inverter overload protector, Fusible plugs, Fuse	High pressure switch, Outdoor fan driver overload protector, Inverter overload protector, Fusible plugs, Fuse
Capacity Control		%	14-100	14-100
Refrigerant control			Electronic expansion valve	Electronic expansion valve
Ref. piping	Standard length	ft (m)	25 (7.6)	25 (7.6)
	Max. length	ft (m)	230 (70)	230 (70)
	Max. height difference	ft (m)	98 (30)	98 (30)
Refrigerant	Model		R-410A	R-410A
	Charge	lbs (kg)	7.9 (3.6)	7.9 (3.6)
Ref. oil	Model		DAPHNE FVC50K	DAPHNE FVC50K
	Charge	L	1.52	1.52
Drawing No.	Specification		C: 4D126356	C: 4D126356
	Sound (outdoor)		C: 4D101949D / C: 4D101950E	C: 4D101949D / C: 4D101950E

Notes:

- ★1 Indoor temp.: 80°FDB (26.7°CDB), 67°FWB (19.4°CWB) / Outdoor temp.: 95°FDB (35.0°CDB) / Equivalent piping length: 25 ft (7.6 m), level difference: 0 ft (0 m).
★2 Indoor temp.: 70°FDB (21.1°CDB) / Outdoor temp.: 47°FDB (8.3°CDB), 43°FWB (6.1°CWB) / Equivalent piping length: 25 ft (7.6 m), level difference: 0 ft (0 m).
★3 Indoor temp.: 70°FDB (21.1°CDB) / Outdoor temp.: 17°FDB (-8.3°CDB), 15°FWB (-9.4°CWB) / Equivalent piping length: 25 ft (7.6 m), level difference: 0 ft (0 m).
★4 Capacities are net, including a deduction for cooling (an addition for heating) for indoor fan motor heat.

Model name		Indoor unit		FHQ42MVJU	
		Outdoor unit		RZQ42TAVJUA	
Power supply				1 phase, 208/230 V, 60 Hz	
★1 ★4 Cooling capacity	Btu/h (kW)	40,500 (11.9)			
★2 ★4 Heating capacity	Btu/h (kW)	40,000 (11.7)			
★3 ★4 Heating capacity	Btu/h (kW)	23,400 (6.9)			
SEER (Rated)				14.0	
EER (Rated)				8.8	
HSPF (Rated)				8.2	
Indoor unit				FHQ42MVJU	
Casing color				White (10Y9/0.5)	
Dimensions: (H×W×D)		in (mm)		7-11/16 × 62-5/8 × 26-3/4 (195 × 1,590 × 680)	
Coil	Type	Cross fin coil			
	Rows×Stages×FPI	2 × 12 × 15 + 2 × 10 × 15			
	Face area	ft ² (m ²)		3.66 (0.34) + 2.95 (0.27)	
Fan	Model	—			
	Type	Sirocco fan			
	Motor output	W		130	
	Airflow rate (H/L)	cfm (m ³ /min)		850 / 700 (24.1 / 19.8)	
Air filter				Resin net (with mold resistance)	
Weight				lbs (kg)	
				90 (19.8)	
Connecting Pipes	Liquid Pipe	in (mm)		φ3/8 (φ9.5) (Flare connection)	
	Gas Pipe	in (mm)		φ5/8 (φ15.9) (Flare connection)	
	Drain Pipe	in (mm)		VP20 (External dia. 1 (26), internal dia. 3/4 (19.1))	
Remote controller (option)	Wired	BRC1E73			
	Wireless	BRC7E83			
Outdoor unit				RZQ42TAVJUA	
Casing color				Ivory white	
Dimensions: (H×W×D)		in (mm)		52-15/16 × 35-7/16 × 12-5/8 (1,345 × 900 × 320)	
Coil	Type	Cross fin coil			
	Rows×Stages×FPI	2 × 60 × 19			
	Face area	ft ² (m ²)		12.2 (1.134)	
Compressor	Model	2YC90FXD#A			
	Type	Hermetically sealed swing type			
	Motor output	kW		3.5	
Fan	Model	P47N			
	Type	Propeller fan			
	Motor output	W		70 × 2	
	Airflow rate	cfm (m ³ /min)		3,741 (106)	
Weight				lbs (kg)	
				225 (102)	
Sound pressure level (Cooling/Heating)				dB(A)	
				57 / 59	
Connecting Pipes	Liquid Pipe	in (mm)		φ3/8 (φ9.5) (Flare connection)	
	Gas Pipe	in (mm)		φ5/8 (φ15.9) (Flare connection)	
	Drain Pipe	in (mm)		φ1 (φ26) (Hole)	
Safety devices				High pressure switch, Outdoor fan driver overload protector, Inverter overload protector, Fusible plugs, Fuse	
Capacity Control				%	
				14-100	
Refrigerant control				Electronic expansion valve	
Ref. piping	Standard length	ft (m)		25 (7.6)	
	Max. length	ft (m)		230 (70)	
	Max. height difference	ft (m)		98 (30)	
Refrigerant	Model	R-410A			
	Charge	lbs (kg)		7.9 (3.6)	
Ref. oil	Model	DAPHNE FVC50K			
	Charge	L		1.52	
Drawing No.	Specification	C: 4D126356			
	Sound (outdoor)	C: 4D101949D / C: 4D101950E			
Notes:					
★1 Indoor temp.: 80°FDB (26.7°CDB), 67°FWB (19.4°CWB) / Outdoor temp.: 95°FDB (35.0°CDB) / Equivalent piping length: 25 ft (7.6 m), level difference: 0 ft (0 m)					
★2 Indoor temp.: 70°FDB (21.1°CDB) / Outdoor temp.: 47°FDB (8.3°CDB), 43°FWB (6.1°CWB) / Equivalent piping length: 25 ft (7.6 m), level difference: 0 ft (0 m).					
★3 Indoor temp.: 70°FDB (21.1°CDB) / Outdoor temp.: 17°FDB (-8.3°CDB), 15°FWB (-9.4°CWB) / Equivalent piping length: 25 ft (7.6 m), level difference: 0 ft (0 m).					
★4 Capacities are net, including a deduction for cooling (an addition for heating) for indoor fan motor heat					

3.2.3 Wall Mounted Type

Model name	Indoor unit		FAQ18TAVJU		FAQ24TAVJU	
	Outdoor unit		RZQ18TAVJU		RZQ24TAVJU	
Power supply			1 phase, 208/230 V, 60 Hz		1 phase, 208/230 V, 60 Hz	
★1 ★4 Cooling capacity	Btu/h (kW)		18,000 (5.3)		24,000 (7.0)	
★2 ★4 Heating capacity	Btu/h (kW)		20,000 (5.9)		27,000 (7.9)	
★3 ★4 Heating capacity	Btu/h (kW)		13,000 (3.8)		20,000 (5.9)	
SEER (Rated)			17.0		17.6	
EER (Rated)			11.9		10.2	
HSPF (Rated)			8.2		8.4	
Indoor unit			FAQ18TAVJU		FAQ24TAVJU	
Casing color			White (3.0Y8.5/0.5)		White (3.0Y8.5/0.5)	
Dimensions: (H×W×D)			in (mm) 11-3/8 × 41-3/8 × 9-1/4 (290 × 1,050 × 238)		in (mm) 11-3/8 × 41-3/8 × 9-1/4 (290 × 1,050 × 238)	
Coil	Type		Cross fin coil		Cross fin coil	
	Rows×Stages×FPI		2 × 14 × 7		2 × 14 × 7	
	Face area	ft ² (m ²)	1.73 (0.16)		1.73 (0.16)	
Fan	Model		QCL9686M		QCL9686M	
	Type		Cross flow fan		Cross flow fan	
	Motor output	W	43		43	
	Airflow rate (H/L)	cfm (m ³ /min)	500/400 (14/11)		635/470 (18/13)	
Sound pressure level (H/L)			dB(A) 43.0/37.0		dB(A) 47.0/41.0	
Air filter			Resin net (washable)		Resin net (washable)	
Weight			lbs (kg) 31 (14)		lbs (kg) 31 (14)	
Connecting Pipes	Liquid Pipe	in (mm)	ϕ3/8 (ϕ9.5) (Flare connection)		ϕ3/8 (ϕ9.5) (Flare connection)	
	Gas Pipe	in (mm)	ϕ5/8 (ϕ15.9) (Flare connection)		ϕ5/8 (ϕ15.9) (Flare connection)	
	Drain Pipe	in (mm)	VP13 (External dia. 11/16 (18), internal dia. 1/2 (13))		VP13 (External dia. 11/16 (18), internal dia. 1/2 (13))	
Remote controller (option)	Wired		BRC1E73, BRC2A71		BRC1E73, BRC2A71	
	Wireless		BRC7E818		BRC7E818	
Outdoor unit			RZQ18TAVJU		RZQ24TAVJU	
Casing color			Ivory white		Ivory white	
Dimensions: (H×W×D)			in (mm) 39 × 37 × 12-5/8 (990 × 940 × 320)		in (mm) 39 × 37 × 12-5/8 (990 × 940 × 320)	
Coil	Type		Cross fin coil		Cross fin coil	
	Rows×Stages×FPI		2 × 44 × 19		2 × 44 × 19	
	Face area	ft ² (m ²)	9.5 (0.88)		9.5 (0.88)	
Compressor	Model		2YC63ABXDD		2YC63ABXDD	
	Type		Hermetically sealed swing type		Hermetically sealed swing type	
	Motor output	kW	1.9		1.9	
Fan	Model		P51J11F		P51J11F	
	Type		Propeller fan		Propeller fan	
	Motor output	W	200		200	
	Airflow rate	cfm (m ³ /min)	2,682 (76)		2,682 (76)	
Weight			lbs (kg) 172 (78)		lbs (kg) 172 (78)	
Sound pressure level (Cooling/Heating)			dB(A) 58 / 61		dB(A) 58 / 61	
Connecting Pipes	Liquid Pipe	in (mm)	ϕ3/8 (ϕ9.5) (Flare connection)		ϕ3/8 (ϕ9.5) (Flare connection)	
	Gas Pipe	in (mm)	ϕ5/8 (ϕ15.9) (Flare connection)		ϕ5/8 (ϕ15.9) (Flare connection)	
	Drain Pipe	in (mm)	ϕ1 (ϕ26) (Hole)		ϕ1 (ϕ26) (Hole)	
Safety devices			High pressure switch, Outdoor fan driver overload protector, Inverter overload protector, Fusible plugs, Fuse		High pressure switch, Outdoor fan driver overload protector, Inverter overload protector, Fusible plugs, Fuse	
Capacity Control			%		14-100	
Refrigerant control			Electronic expansion valve		Electronic expansion valve	
Ref. piping	Standard length	ft (m)	25 (7.6)		25 (7.6)	
	Max. length	ft (m)	164 (50)		164 (50)	
	Max. height difference	ft (m)	98 (30)		98 (30)	
Refrigerant	Model		R-410A		R-410A	
	Charge	lbs (kg)	6.4 (2.9)		6.4 (2.9)	
Ref. oil	Model		DAPHNE FVC50K		DAPHNE FVC50K	
	Charge	L	1.08		1.08	
Drawing No.	Specification		C: 4D115551		C: 4D115551	
	Sound (indoor)		C: 4D075583A		C: 4D075584A	
	Sound (outdoor)		C: 4D101947D / C: 4D101948E		C: 4D101947D / C: 4D101948E	

Notes:

- ★1 Indoor temp.: 80°FDB (26.7°CDB), 67°FWB (19.4°CWB) / Outdoor temp.: 95°FDB (35.0°CDB) / Equivalent piping length: 25 ft (7.6 m), level difference: 0 ft (0 m).
 ★2 Indoor temp.: 70°FDB (21.1°CDB) / Outdoor temp.: 47°FDB (8.3°CDB), 43°FWB (6.1°CWB) / Equivalent piping length: 25 ft (7.6 m), level difference: 0 ft (0 m).
 ★3 Indoor temp.: 70°FDB (21.1°CDB) / Outdoor temp.: 17°FDB (-8.3°CDB), 15°FWB (-9.4°CWB) / Equivalent piping length: 25 ft (7.6 m), level difference: 0 ft (0 m).
 ★4 Capacities are net, including a deduction for cooling (an addition for heating) for indoor fan motor heat.

Model name	Indoor unit		FAQ18TAVJU	FAQ24TAVJU
	Outdoor unit		RZQ18TAVJUA	RZQ24TAVJUA
Power supply			1 phase, 208/230 V, 60 Hz	1 phase, 208/230 V, 60 Hz
★1 ★4 Cooling capacity	Btu/h (kW)		18,000 (5.3)	24,000 (7.0)
★2 ★4 Heating capacity	Btu/h (kW)		20,000 (5.9)	27,000 (7.9)
★3 ★4 Heating capacity	Btu/h (kW)		13,000 (3.8)	20,000 (5.9)
SEER (Rated)			17.0	17.6
EER (Rated)			11.9	10.2
HSPF (Rated)			8.2	8.4
Indoor unit			FAQ18TAVJU	FAQ24TAVJU
Casing color			White (3.0Y8.5/0.5)	White (3.0Y8.5/0.5)
Dimensions: (H×W×D)			11-3/8 × 41-3/8 × 9-1/4 (290 × 1,050 × 238)	11-3/8 × 41-3/8 × 9-1/4 (290 × 1,050 × 238)
Coil	Type		Cross fin coil	Cross fin coil
	Rows×Stages×FPI		2 × 14 × 7	2 × 14 × 7
	Face area	ft ² (m ²)	1.73 (0.16)	1.73 (0.16)
Fan	Model		QCL9686M	QCL9686M
	Type		Cross flow fan	Cross flow fan
	Motor output	W	43	43
	Airflow rate (H/L)	cfm (m ³ /min)	500/400 (14/11)	635/470 (18/13)
Sound pressure level (H/L)			43.0/37.0	47.0/41.0
Air filter			Resin net (washable)	Resin net (washable)
Weight			31 (14)	31 (14)
Connecting Pipes	Liquid Pipe	in (mm)	φ3/8 (φ9.5) (Flare connection)	φ3/8 (φ9.5) (Flare connection)
	Gas Pipe	in (mm)	φ5/8 (φ15.9) (Flare connection)	φ5/8 (φ15.9) (Flare connection)
	Drain Pipe	in (mm)	VP13 (External dia. 11/16 (18), internal dia. 1/2 (13))	VP13 (External dia. 11/16 (18), internal dia. 1/2 (13))
Remote controller (option)	Wired		BRC1E73, BRC2A71	BRC1E73, BRC2A71
	Wireless		BRC7E818	BRC7E818
Outdoor unit			RZQ18TAVJUA	RZQ24TAVJUA
Casing color			Ivory white	Ivory white
Dimensions: (H×W×D)			39 × 37 × 12-5/8 (990 × 940 × 320)	39 × 37 × 12-5/8 (990 × 940 × 320)
Coil	Type		Cross fin coil	Cross fin coil
	Rows×Stages×FPI		2 × 44 × 19	2 × 44 × 19
	Face area	ft ² (m ²)	9.5 (0.88)	9.5 (0.88)
Compressor	Model		2YC63TXD#A	2YC63TXD#A
	Type		Hermetically sealed swing type	Hermetically sealed swing type
	Motor output	kW	1.9	1.9
Fan	Model		P51J11F	P51J11F
	Type		Propeller fan	Propeller fan
	Motor output	W	200	200
	Airflow rate	cfm (m ³ /min)	2,682 (76)	2,682 (76)
Weight			172 (78)	172 (78)
Sound pressure level (Cooling/Heating)			58 / 61	58 / 61
Connecting Pipes	Liquid Pipe	in (mm)	φ3/8 (φ9.5) (Flare connection)	φ3/8 (φ9.5) (Flare connection)
	Gas Pipe	in (mm)	φ5/8 (φ15.9) (Flare connection)	φ5/8 (φ15.9) (Flare connection)
	Drain Pipe	in (mm)	φ1 (φ26) (Hole)	φ1 (φ26) (Hole)
Safety devices			High pressure switch, Outdoor fan driver overload protector, Inverter overload protector, Fusible plugs, Fuse	High pressure switch, Outdoor fan driver overload protector, Inverter overload protector, Fusible plugs, Fuse
Capacity Control			14-100	14-100
Refrigerant control			Electronic expansion valve	Electronic expansion valve
Ref. piping	Standard length	ft (m)	25 (7.6)	25 (7.6)
	Max. length	ft (m)	164 (50)	164 (50)
	Max. height difference	ft (m)	98 (30)	98 (30)
Refrigerant	Model		R-410A	R-410A
	Charge	lbs (kg)	6.4 (2.9)	6.4 (2.9)
Ref. oil	Model		DAPHNE FVC50K	DAPHNE FVC50K
	Charge	L	1.08	1.08
Drawing No.	Specification		C: 4D126346	C: 4D126346
	Sound (indoor)		C: 4D075583A	C: 4D075584A
	Sound (outdoor)		C: 4D101947D / C: 4D101948E	C: 4D101947D / C: 4D101948E

Notes:
★1 Indoor temp.: 80°FDB (26.7°CDB), 67°FWB (19.4°CWB) / Outdoor temp.: 95°FDB (35.0°CDB) / Equivalent piping length: 25 ft (7.6 m), level difference: 0 ft (0 m).
★2 Indoor temp.: 70°FDB (21.1°CDB) / Outdoor temp.: 47°FDB (8.3°CDB), 43°FWB (6.1°CWB) / Equivalent piping length: 25 ft (7.6 m), level difference: 0 ft (0 m).
★3 Indoor temp.: 70°FDB (21.1°CDB) / Outdoor temp.: 17°FDB (-8.3°CDB), 15°FWB (-9.4°CWB) / Equivalent piping length: 25 ft (7.6 m), level difference: 0 ft (0 m).
★4 Capacities are net, including a deduction for cooling (an addition for heating) for indoor fan motor heat.

Model name		Indoor unit		FAQ18TAVJU		FAQ24TAVJU		
		Outdoor unit		RZQ18TBVJUA		RZQ24TBVJUA		
Power supply				1 phase, 208/230 V, 60 Hz		1 phase, 208/230 V, 60 Hz		
★1 ★4 Cooling capacity	Btu/h (kW)			18,000 (5.3)		24,000 (7.0)		
★2 ★4 Heating capacity	Btu/h (kW)			20,000 (5.9)		27,000 (7.9)		
★3 ★4 Heating capacity	Btu/h (kW)			13,800 (4.0)		20,000 (5.9)		
Indoor unit				FAQ18TAVJU		FAQ24TAVJU		
Casing color				White (3.0Y8.5/0.5)		White (3.0Y8.5/0.5)		
Dimensions: (H×W×D)		in (mm)		11-3/8 × 41-3/8 × 9-1/4 (290 × 1,050 × 238)		11-3/8 × 41-3/8 × 9-1/4 (290 × 1,050 × 238)		
Coil	Type				Cross fin coil		Cross fin coil	
	Type				Cross flow fan		Cross flow fan	
Fan	Motor output		W		43		43	
	Airflow rate (H/L)		cfm (m ³ /min)		500/400 (14/11)		635/470 (18/13)	
Sound pressure level (H/L)		dB(A)		43.0/37.0		47.0/41.0		
Air filter				Resin net (washable)		Resin net (washable)		
Weight		lbs (kg)		31 (14)		31 (14)		
Connecting Pipes	Liquid Pipe		in (mm)		φ3/8 (φ9.5) (Flare connection)		φ3/8 (φ9.5) (Flare connection)	
	Gas Pipe		in (mm)		φ5/8 (φ15.9) (Flare connection)		φ5/8 (φ15.9) (Flare connection)	
	Drain Pipe		in (mm)		VP13 (External dia. 11/16 (18), internal dia. 1/2 (13))		VP13 (External dia. 11/16 (18), internal dia. 1/2 (13))	
Remote controller (accessory)	Wired				BRC1E73, BRC1H71W		BRC1E73, BRC1H71W	
	Wireless				BRC7E818		BRC7E818	
Outdoor unit				RZQ18TBVJUA		RZQ24TBVJUA		
Casing color				Ivory white		Ivory white		
Dimensions: (H×W×D)		in (mm)		39 × 37 × 12-5/8 (990 × 940 × 320)		39 × 37 × 12-5/8 (990 × 940 × 320)		
Coil	Type				Cross fin coil		Cross fin coil	
	Type				Hermetically sealed swing type		Hermetically sealed swing type	
Compressor	Motor output		kW		1.9		1.9	
	Type				Propeller fan		Propeller fan	
Fan	Motor output		W		200		200	
	Airflow rate		cfm (m ³ /min)		2,682 (76)		2,682 (76)	
Weight		lbs (kg)		172 (78)		172 (78)		
Sound pressure level (Cooling/Heating)		dB(A)		58 / 61		58 / 61		
Connecting Pipes	Liquid Pipe		in (mm)		φ3/8 (φ9.5) (Flare connection)		φ3/8 (φ9.5) (Flare connection)	
	Gas Pipe		in (mm)		φ5/8 (φ15.9) (Flare connection)		φ5/8 (φ15.9) (Flare connection)	
	Drain Pipe		in (mm)		φ1 (φ26) (Hole)		φ1 (φ26) (Hole)	
Safety devices				High pressure switch, Outdoor fan driver overload protector, Inverter overload protector, Fusible plug, Fuse		High pressure switch, Outdoor fan driver overload protector, Inverter overload protector, Fusible plug, Fuse		
Capacity step		%		14-100		14-100		
Refrigerant control				Electronic expansion valve		Electronic expansion valve		
Ref. piping	Standard length		ft (m)		25 (7.6)		25 (7.6)	
	Max. length		ft (m)		164 (50)		164 (50)	
	Max. height difference		ft (m)		98 (30)		98 (30)	
Refrigerant	Type				R-410A		R-410A	
	Charge		lbs (kg)		6.4 (2.9)		6.4 (2.9)	
Ref. oil	Type				DAPHNE FVC50K		DAPHNE FVC50K	
	Charge		L		1.08		1.08	
Drawing No.	Specification				4D143005A		4D143005A	
	Sound (indoor)				4D075583A		4D075584A	
	Sound (outdoor)				4D101947D / 4D101948E		4D101947D / 4D101948E	
Notes:								
★1 Indoor temp.: 80°FDB (26.7°CDB), 67°FWB (19.4°CWB) / Outdoor temp.: 95°FDB (35.0°CDB) / Equivalent piping length: 25 ft (7.6 m), height difference: 0 ft (0 m).								
★2 Indoor temp.: 70°FDB (21.1°CDB) / Outdoor temp.: 47°FDB (8.3°CDB), 43°FWB (6.1°CWB) / Equivalent piping length: 25 ft (7.6 m), height difference: 0 ft (0 m).								
★3 Indoor temp.: 70°FDB (21.1°CDB) / Outdoor temp.: 17°FDB (-8.3°CDB), 15°FWB (-9.4°CWB) / Equivalent piping length: 25 ft (7.6 m), height difference: 0 ft (0 m).								
★4 Capacities are net, including a deduction for cooling (an addition for heating) for indoor fan motor heat.								

3.2.4 HSP Ceiling Mounted Duct Type

Model name	Indoor unit		FBQ18PVJU		FBQ24PVJU	
	Outdoor unit		RZQ18TAVJU		RZQ24TAVJU	
Power supply			1 phase, 208/230 V, 60 Hz		1 phase, 208/230 V, 60 Hz	
★1 ★4 Cooling capacity	Btu/h (kW)		18,000 (5.3)		24,000 (7.0)	
★2 ★4 Heating capacity	Btu/h (kW)		20,000 (5.9)		27,000 (7.9)	
★3 ★4 Heating capacity	Btu/h (kW)		12,000 (3.5)		18,000 (5.3)	
SEER (Rated)			16.7		16.5	
EER (Rated)	Btu/h-W		13.0		12.0	
HSPF (Rated)			9.5		9.7	
Indoor unit			FBQ18PVJU		FBQ24PVJU	
Casing color			Galvanized steel plate		Galvanized steel plate	
Dimensions: (H×W×D)			in (mm) 11-13/16 × 39-3/8 × 27-9/16 (300 × 1,000 × 700)		11-13/16 × 39-3/8 × 27-9/16 (300 × 1,000 × 700)	
Coil	Type		Cross fin coil		Cross fin coil	
	Rows×Stages×FPI		3 × 16 × 15		3 × 16 × 15	
	Face area	ft ² (m ²)	2.68 (0.249)		2.68 (0.249)	
Fan	Model		—		—	
	Type		Sirocco fan		Sirocco fan	
	Motor output	W	350		350	
	Airflow rate (HH/H/L)	cfm (m ³ /min)	635/582/529 (18.0/16.5/15.0)		688/618/565 (19.5/17.5/16.0)	
	External static pressure	inH ₂ O (Pa)	Standard 0.40 <0.80-0.20> (100 <200-50>) ★5		Standard 0.40 <0.80-0.20> (100 <200-50>) ★5	
Sound pressure level (HH/H/L)	dB(A)	41.0/39.0/37.0		42.0/40.0/38.0		
Air filter			—★6		—★6	
Weight	lbs (kg)	80 (36)		80 (36)		
Connecting Pipes	Liquid Pipe	in (mm)	φ3/8 (φ9.5) (Flare connection)		φ3/8 (φ9.5) (Flare connection)	
	Gas Pipe	in (mm)	φ5/8 (φ15.9) (Flare connection)		φ5/8 (φ15.9) (Flare connection)	
	Drain Pipe	in (mm)	VP25 (External dia. 1-1/4 (32), internal dia. 1 (26))		VP25 (External dia. 1-1/4 (32), internal dia. 1 (26))	
Remote controller (option)	Wired	BRC1E73, BRC2A71		BRC1E73, BRC2A71		
	Wireless	BRC4C82, BRC082A43		BRC4C82, BRC082A43		
Outdoor unit			RZQ18TAVJU		RZQ24TAVJU	
Casing color			Ivory white		Ivory white	
Dimensions: (H×W×D)			in (mm) 39 × 37 × 12-5/8 (990 × 940 × 320)		39 × 37 × 12-5/8 (990 × 940 × 320)	
Coil	Type		Cross fin coil		Cross fin coil	
	Rows×Stages×FPI		2 × 44 × 19		2 × 44 × 19	
	Face area	ft ² (m ²)	9.5 (0.88)		9.5 (0.88)	
Compressor	Model		2YC63ABXDD		2YC63ABXDD	
	Type		Hermetically sealed swing type		Hermetically sealed swing type	
	Motor output	kW	1.9		1.9	
Fan	Model		P51J11F		P51J11F	
	Type		Propeller fan		Propeller fan	
	Motor output	W	200		200	
	Airflow rate	cfm (m ³ /min)	2,682 (76)		2,682 (76)	
Weight	lbs (kg)	172 (78)		172 (78)		
Sound pressure level (Cooling/Heating)	dB(A)	58 / 61		58 / 61		
Connecting Pipes	Liquid Pipe	in (mm)	φ3/8 (φ9.5) (Flare connection)		φ3/8 (φ9.5) (Flare connection)	
	Gas Pipe	in (mm)	φ5/8 (φ15.9) (Flare connection)		φ5/8 (φ15.9) (Flare connection)	
	Drain Pipe	in (mm)	φ1 (φ26) (Hole)		φ1 (φ26) (Hole)	
Safety devices			High pressure switch, Outdoor fan driver overload protector, Inverter overload protector, Fusible plugs, Fuse		High pressure switch, Outdoor fan driver overload protector, Inverter overload protector, Fusible plugs, Fuse	
Capacity Control	%	14-100		14-100		
Refrigerant control			Electronic expansion valve		Electronic expansion valve	
Ref. piping	Standard length	ft (m)	25 (7.6)		25 (7.6)	
	Max. length	ft (m)	164 (50)		164 (50)	
	Max. height difference	ft (m)	98 (30)		98 (30)	
Refrigerant	Model		R-410A		R-410A	
	Charge	lbs (kg)	6.4 (2.9)		6.4 (2.9)	
Ref. oil	Model		DAPHNE FVC50K		DAPHNE FVC50K	
	Charge	L	1.08		1.08	
Drawing No.	Specification		C: 4D115553		C: 4D115553	
	Sound (indoor)		C: 4D075278		C: 4D075279	
	Sound (outdoor)		C: 4D101947D / C: 4D101948E		C: 4D101947D / C: 4D101948E	

Notes:

- ★1 Indoor temp.: 80°FDB (26.7°CDB), 67°FWB (19.4°CWB) / Outdoor temp.: 95°FDB (35.0°CDB) / Equivalent piping length: 25 ft (7.6 m), level difference: 0 ft (0 m).
- ★2 Indoor temp.: 70°FDB (21.1°CDB) / Outdoor temp.: 47°FDB (8.3°CDB), 43°FWB (6.1°CWB) / Equivalent piping length: 25 ft (7.6 m), level difference: 0 ft (0 m).
- ★3 Indoor temp.: 70°FDB (21.1°CDB) / Outdoor temp.: 17°FDB (-8.3°CDB), 15°FWB (-9.4°CWB) / Equivalent piping length: 25 ft (7.6 m), level difference: 0 ft (0 m).
- ★4 Capacities are net, including a deduction for cooling (an addition for heating) for indoor fan motor heat.
- ★5 External static pressure is changeable in 14 stages within the < > range by remote controller.
- ★6 Air filter is not standard accessory, but please mount it in the duct system of the suction side. Select its dust collection efficiency (gravity method) 50% or more.

Model name		Indoor unit	FBQ30PVJU	FBQ36PVJU
		Outdoor unit	RZQ30TAVJU	RZQ36TAVJU
Power supply			1 phase, 208/230 V, 60 Hz	1 phase, 208/230 V, 60 Hz
★1 ★4 Cooling capacity	Btu/h (kW)		30,000 (8.8)	36,000 (10.6)
★2 ★4 Heating capacity	Btu/h (kW)		34,000 (10.0)	40,000 (11.7)
★3 ★4 Heating capacity	Btu/h (kW)		22,000 (6.4)	21,000 (6.2)
SEER (Rated)			16.0	17.5
EER (Rated)	Btu/h-W		10.5	11.1
HSPF (Rated)			9.2	9.1
Indoor unit			FBQ30PVJU	FBQ36PVJU
Casing color			Galvanized steel plate	Galvanized steel plate
Dimensions: (H×W×D)		in (mm)	11-13/16 × 39-3/8 × 27-9/16 (300 × 1,000 × 700)	11-13/16 × 55-1/8 × 27-9/16 (300 × 1,400 × 700)
Coil	Type		Cross fin coil	Cross fin coil
	Rows×Stages×FPI		3 × 16 × 15	3 × 16 × 15
	Face area	ft ² (m ²)	2.68 (0.249)	4.12 (0.383)
Fan	Model		—	—
	Type		Sirocco fan	Sirocco fan
	Motor output	W	350	350
	Airflow rate (HH/H/L)	cfm (m ³ /min)	882/794/706 (25.0/22.0/20.0)	1,130/953/812 (32.0/27.0/23.0)
	External static pressure	inH ₂ O (Pa)	Standard 0.40 <0.80-0.20> (100 <200-50>) ★5	Standard 0.40 <0.80-0.20> (100 <200-50>) ★5
Sound pressure level (HH/H/L)	dB(A)		43.0/41.0/39.0	43.0/41.0/39.0
Air filter			—★6	—★6
Weight	lbs (kg)		80 (36)	102 (46)
Connecting Pipes	Liquid Pipe	in (mm)	φ3/8 (φ9.5) (Flare connection)	φ3/8 (φ9.5) (Flare connection)
	Gas Pipe	in (mm)	φ5/8 (φ15.9) (Flare connection)	φ5/8 (φ15.9) (Flare connection)
	Drain Pipe	in (mm)	VP25 (External dia. 1-1/4 (32), internal dia. 1 (26))	VP25 (External dia. 1-1/4 (32), internal dia. 1 (26))
Remote controller (option)	Wired		BRC1E73, BRC2A71	BRC1E73, BRC2A71
	Wireless		BRC4C82, BRC082A43	BRC4C82, BRC082A43
Outdoor unit			RZQ30TAVJU	RZQ36TAVJU
Casing color			Ivory white	Ivory white
Dimensions: (H×W×D)		in (mm)	52-15/16 × 35-7/16 × 12-5/8 (1,345 × 900 × 320)	52-15/16 × 35-7/16 × 12-5/8 (1,345 × 900 × 320)
Coil	Type		Cross fin coil	Cross fin coil
	Rows×Stages×FPI		2 × 60 × 19	2 × 60 × 19
	Face area	ft ² (m ²)	12.2 (1.134)	12.2 (1.134)
Compressor	Model		2YC90GXD#D	2YC90GXD#D
	Type		Hermetically sealed swing type	Hermetically sealed swing type
	Motor output	kW	3.5	3.5
Fan	Model		P47N	P47N
	Type		Propeller fan	Propeller fan
	Motor output	W	70 × 2	70 × 2
	Airflow rate	cfm (m ³ /min)	3,741 (106)	3,741 (106)
Weight	lbs (kg)		225 (102)	225 (102)
Sound pressure level (Cooling/Heating)	dB(A)		57 / 59	57 / 59
Connecting Pipes	Liquid Pipe	in (mm)	φ3/8 (φ9.5) (Flare connection)	φ3/8 (φ9.5) (Flare connection)
	Gas Pipe	in (mm)	φ5/8 (φ15.9) (Flare connection)	φ5/8 (φ15.9) (Flare connection)
	Drain Pipe	in (mm)	φ1 (φ26) (Hole)	φ1 (φ26) (Hole)
Safety devices		High pressure switch, Outdoor fan driver overload protector, Inverter overload protector, Fusible plugs, Fuse	High pressure switch, Outdoor fan driver overload protector, Inverter overload protector, Fusible plugs, Fuse	
Capacity Control	%		14-100	14-100
Refrigerant control			Electronic expansion valve	Electronic expansion valve
Ref. piping	Standard length	ft (m)	25 (7.6)	25 (7.6)
	Max. length	ft (m)	230 (70)	230 (70)
	Max. height difference	ft (m)	98 (30)	98 (30)
Refrigerant	Model		R-410A	R-410A
	Charge	lbs (kg)	7.9 (3.6)	7.9 (3.6)
Ref. oil	Model		DAPHNE FVC50K	DAPHNE FVC50K
	Charge	L	1.52	1.52
Drawing No.	Specification		C: 4D115555A	C: 4D115555A
	Sound (indoor)		C: 4D075280	C: 4D075281
	Sound (outdoor)		C: 4D101949D / C: 4D101950E	C: 4D101949D / C: 4D101950E

Notes:

- ★1 Indoor temp.: 80°FDB (26.7°CDB), 67°FWB (19.4°CWB) / Outdoor temp.: 95°FDB (35.0°CDB) / Equivalent piping length: 25 ft (7.6 m), level difference: 0 ft (0 m).
★2 Indoor temp.: 70°FDB (21.1°CDB) / Outdoor temp.: 47°FDB (8.3°CDB), 43°FWB (6.1°CWB) / Equivalent piping length: 25 ft (7.6 m), level difference: 0 ft (0 m).
★3 Indoor temp.: 70°FDB (21.1°CDB) / Outdoor temp.: 17°FDB (-8.3°CDB), 15°FWB (-9.4°CWB) / Equivalent piping length: 25 ft (7.6 m), level difference: 0 ft (0 m).
★4 Capacities are net, including a deduction for cooling (an addition for heating) for indoor fan motor heat.
★5 External static pressure is changeable in 14 stages within the < > range by remote controller.
★6 Air filter is not standard accessory, but please mount it in the duct system of the suction side. Select its dust collection efficiency (gravity method) 50% or more.

Model name	Indoor unit		FBQ42PVJU	FBQ48PVJU
	Outdoor unit		RZQ42TAVJU	RZQ48TAVJU
Power supply			1 phase, 208/230 V, 60 Hz	1 phase, 208/230 V, 60 Hz
★1 ★4 Cooling capacity	Btu/h (kW)		40,500 (11.9)	48,000 (14.1)
★2 ★4 Heating capacity	Btu/h (kW)		47,000 (13.8)	54,000 (15.8)
★3 ★4 Heating capacity	Btu/h (kW)		25,000 (7.3)	28,000 (8.2)
SEER (Rated)			16.0	14.0
EER (Rated)			10.1	8.6
HSPF (Rated)			8.8	8.4
Indoor unit			FBQ42PVJU	FBQ48PVJU
Casing color			Galvanized steel plate	Galvanized steel plate
Dimensions: (H×W×D)			11-13/16 × 55-1/8 × 27-9/16 (300 × 1,400 × 700)	11-13/16 × 55-1/8 × 27-9/16 (300 × 1,400 × 700)
Coil	Type		Cross fin coil	Cross fin coil
	Rows×Stages×FPI		3 × 16 × 15	3 × 16 × 15
	Face area	ft ² (m ²)	4.12 (0.383)	4.12 (0.383)
Fan	Model		—	—
	Type		Sirocco fan	Sirocco fan
	Motor output	W	350	350
	Airflow rate (HH/H/L)	cfm (m ³ /min)	1,400/1,165/988 (39.6/33.0/28.0)	1,400/1,165/988 (39.6/33.0/28.0)
	External static pressure	inH ₂ O (Pa)	Standard 0.40 <0.80-0.20> (100 <200-50>) ★5	Standard 0.40 <0.80-0.20> (100 <200-50>) ★5
Sound pressure level (HH/H/L)			44.0/42.0/40.0	44.0/42.0/40.0
Air filter			—★6	—★6
Weight			102 (46)	102 (46)
Connecting Pipes	Liquid Pipe	in (mm)	φ3/8 (φ9.5) (Flare connection)	φ3/8 (φ9.5) (Flare connection)
	Gas Pipe	in (mm)	φ5/8 (φ15.9) (Flare connection)	φ5/8 (φ15.9) (Flare connection)
	Drain Pipe	in (mm)	VP25 (External dia. 1-1/4 (32), internal dia. 1 (26))	VP25 (External dia. 1-1/4 (32), internal dia. 1 (26))
Remote controller (option)	Wired		BRC1E73, BRC2A71	BRC1E73, BRC2A71
	Wireless		BRC4C82, BRC082A43	BRC4C82, BRC082A43
Outdoor unit			RZQ42TAVJU	RZQ48TAVJU
Casing color			Ivory white	Ivory white
Dimensions: (H×W×D)			52-15/16 × 35-7/16 × 12-5/8 (1,345 × 900 × 320)	52-15/16 × 35-7/16 × 12-5/8 (1,345 × 900 × 320)
Coil	Type		Cross fin coil	Cross fin coil
	Rows×Stages×FPI		2 × 60 × 19	2 × 60 × 19
	Face area	ft ² (m ²)	12.2 (1.134)	12.2 (1.134)
Compressor	Model		2YC90GXD#D	2YC90GXD#D
	Type		Hermetically sealed swing type	Hermetically sealed swing type
	Motor output	kW	3.5	3.5
Fan	Model		P47N	P47N
	Type		Propeller fan	Propeller fan
	Motor output	W	70 × 2	70 × 2
	Airflow rate	cfm (m ³ /min)	3,741 (106)	3,741 (106)
Weight			225 (102)	225 (102)
Sound pressure level (Cooling/Heating)			57 / 59	57 / 59
Connecting Pipes	Liquid Pipe	in (mm)	φ3/8 (φ9.5) (Flare connection)	φ3/8 (φ9.5) (Flare connection)
	Gas Pipe	in (mm)	φ5/8 (φ15.9) (Flare connection)	φ5/8 (φ15.9) (Flare connection)
	Drain Pipe	in (mm)	φ1 (φ26) (Hole)	φ1 (φ26) (Hole)
Safety devices			High pressure switch, Outdoor fan driver overload protector, Inverter overload protector, Fusible plugs, Fuse	High pressure switch, Outdoor fan driver overload protector, Inverter overload protector, Fusible plugs, Fuse
Capacity Control			14-100	14-100
Refrigerant control			Electronic expansion valve	Electronic expansion valve
Ref. piping	Standard length	ft (m)	25 (7.6)	25 (7.6)
	Max. length	ft (m)	230 (70)	230 (70)
	Max. height difference	ft (m)	98 (30)	98 (30)
Refrigerant	Model		R-410A	R-410A
	Charge	lbs (kg)	7.9 (3.6)	7.9 (3.6)
Ref. oil	Model		DAPHNE FVC50K	DAPHNE FVC50K
	Charge	L	1.52	1.52
Drawing No.	Specification		C: 4D115555A	C: 4D115555A
	Sound (indoor)		C: 4D075282A	C: 4D075282A
	Sound (outdoor)		C: 4D101949D / C: 4D101950E	C: 4D101949D / C: 4D101950E

Notes:

- ★1 Indoor temp.: 80°FDB (26.7°CDB), 67°FWB (19.4°CWB) / Outdoor temp.: 95°FDB (35.0°CDB) / Equivalent piping length: 25 ft (7.6 m), level difference: 0 ft (0 m).
- ★2 Indoor temp.: 70°FDB (21.1°CDB) / Outdoor temp.: 47°FDB (8.3°CDB), 43°FWB (6.1°CWB) / Equivalent piping length: 25 ft (7.6 m), level difference: 0 ft (0 m).
- ★3 Indoor temp.: 70°FDB (21.1°CDB) / Outdoor temp.: 17°FDB (-8.3°CDB), 15°FWB (-9.4°CWB) / Equivalent piping length: 25 ft (7.6 m), level difference: 0 ft (0 m).
- ★4 Capacities are net, including a deduction for cooling (an addition for heating) for indoor fan motor heat.
- ★5 External static pressure is changeable in 14 stages within the < > range by remote controller.
- ★6 Air filter is not standard accessory, but please mount it in the duct system of the suction side. Select its dust collection efficiency (gravity method) 50% or more.

Model name		Indoor unit	FBQ18PVJU	FBQ24PVJU
		Outdoor unit	RZQ18TAVJUA	RZQ24TAVJUA
Power supply			1 phase, 208/230 V, 60 Hz	1 phase, 208/230 V, 60 Hz
★1 ★4 Cooling capacity	Btu/h (kW)		18,000 (5.3)	24,000 (7.0)
★2 ★4 Heating capacity	Btu/h (kW)		20,000 (5.9)	27,000 (7.9)
★3 ★4 Heating capacity	Btu/h (kW)		12,000 (3.5)	18,000 (5.3)
SEER (Rated)			16.7	16.5
EER (Rated)		Btu/h-W	13.0	12.0
HSPF (Rated)			9.5	9.7
Indoor unit			FBQ18PVJU	FBQ24PVJU
Casing color			Galvanized steel plate	Galvanized steel plate
Dimensions: (H×W×D)		in (mm)	11-13/16 × 39-3/8 × 27-9/16 (300 × 1,000 × 700)	11-13/16 × 39-3/8 × 27-9/16 (300 × 1,000 × 700)
Coil	Type		Cross fin coil	Cross fin coil
	Rows×Stages×FPI		3 × 16 × 15	3 × 16 × 15
	Face area	ft ² (m ²)	2.68 (0.249)	2.68 (0.249)
Fan	Model		—	—
	Type		Sirocco fan	Sirocco fan
	Motor output	W	350	350
	Airflow rate (HH/H/L)	cfm (m ³ /min)	635/582/529 (18.0/16.5/15.0)	688/618/565 (19.5/17.5/16.0)
	External static pressure	inH ₂ O (Pa)	Standard 0.40 <0.80-0.20> (100 <200-50>) ★5	Standard 0.40 <0.80-0.20> (100 <200-50>) ★5
Sound pressure level (HH/H/L)		dB(A)	41.0/39.0/37.0	42.0/40.0/38.0
Air filter			—★6	—★6
Weight		lbs (kg)	80 (36)	80 (36)
Connecting Pipes	Liquid Pipe	in (mm)	φ3/8 (φ9.5) (Flare connection)	φ3/8 (φ9.5) (Flare connection)
	Gas Pipe	in (mm)	φ5/8 (φ15.9) (Flare connection)	φ5/8 (φ15.9) (Flare connection)
	Drain Pipe	in (mm)	VP25 (External dia. 1-1/4 (32), internal dia. 1 (26))	VP25 (External dia. 1-1/4 (32), internal dia. 1 (26))
Remote controller (option)	Wired		BRC1E73, BRC2A71	BRC1E73, BRC2A71
	Wireless		BRC4C82, BRC082A43	BRC4C82, BRC082A43
Outdoor unit			RZQ18TAVJUA	RZQ24TAVJUA
Casing color			Ivory white	Ivory white
Dimensions: (H×W×D)		in (mm)	39 × 37 × 12-5/8 (990 × 940 × 320)	39 × 37 × 12-5/8 (990 × 940 × 320)
Coil	Type		Cross fin coil	Cross fin coil
	Rows×Stages×FPI		2 × 44 × 19	2 × 44 × 19
	Face area	ft ² (m ²)	9.5 (0.88)	9.5 (0.88)
Compressor	Model		2YC63TXD#A	2YC63TXD#A
	Type		Hermetically sealed swing type	Hermetically sealed swing type
	Motor output	kW	1.9	1.9
Fan	Model		P51J11F	P51J11F
	Type		Propeller fan	Propeller fan
	Motor output	W	200	200
	Airflow rate	cfm (m ³ /min)	2,682 (76)	2,682 (76)
Weight		lbs (kg)	172 (78)	172 (78)
Sound pressure level (Cooling/Heating)		dB(A)	58 / 61	58 / 61
Connecting Pipes	Liquid Pipe	in (mm)	φ3/8 (φ9.5) (Flare connection)	φ3/8 (φ9.5) (Flare connection)
	Gas Pipe	in (mm)	φ5/8 (φ15.9) (Flare connection)	φ5/8 (φ15.9) (Flare connection)
	Drain Pipe	in (mm)	φ1 (φ26) (Hole)	φ1 (φ26) (Hole)
Safety devices			High pressure switch, Outdoor fan driver overload protector, Inverter overload protector, Fusible plugs, Fuse	High pressure switch, Outdoor fan driver overload protector, Inverter overload protector, Fusible plugs, Fuse
Capacity Control		%	14-100	14-100
Refrigerant control			Electronic expansion valve	Electronic expansion valve
Ref. piping	Standard length	ft (m)	25 (7.6)	25 (7.6)
	Max. length	ft (m)	164 (50)	164 (50)
	Max. height difference	ft (m)	98 (30)	98 (30)
Refrigerant	Model		R-410A	R-410A
	Charge	lbs (kg)	6.4 (2.9)	6.4 (2.9)
Ref. oil	Model		DAPHNE FVC50K	DAPHNE FVC50K
	Charge	L	1.08	1.08
Drawing No.	Specification		C: 4D126350	C: 4D126350
	Sound (indoor)		C: 4D075278	C: 4D075279
	Sound (outdoor)		C: 4D101947D / C: 4D101948E	C: 4D101947D / C: 4D101948E

Notes:

★1 Indoor temp.: 80°FDB (26.7°CDB), 67°FWB (19.4°CWB) / Outdoor temp.: 95°FDB (35.0°CDB) / Equivalent piping length: 25 ft (7.6 m), level difference: 0 ft (0 m).

★2 Indoor temp.: 70°FDB (21.1°CDB) / Outdoor temp.: 47°FDB (8.3°CDB), 43°FWB (6.1°CWB) / Equivalent piping length: 25 ft (7.6 m), level difference: 0 ft (0 m).

★3 Indoor temp.: 70°FDB (21.1°CDB) / Outdoor temp.: 17°FDB (-8.3°CDB), 15°FWB (-9.4°CWB) / Equivalent piping length: 25 ft (7.6 m), level difference: 0 ft (0 m).

★4 Capacities are net, including a deduction for cooling (an addition for heating) for indoor fan motor heat.

★5 External static pressure is changeable in 14 stages within the < > range by remote controller.

★6 Air filter is not standard accessory, but please mount it in the duct system of the suction side. Select its dust collection efficiency (gravity method) 50% or more.

Model name		Indoor unit	FBQ30PVJU	FBQ36PVJU
		Outdoor unit	RZQ30TAVJUA	RZQ36TAVJUA
Power supply			1 phase, 208/230 V, 60 Hz	1 phase, 208/230 V, 60 Hz
★1 ★4 Cooling capacity	Btu/h (kW)		30,000 (8.8)	36,000 (10.6)
★2 ★4 Heating capacity	Btu/h (kW)		34,000 (10.0)	40,000 (11.7)
★3 ★4 Heating capacity	Btu/h (kW)		22,000 (6.4)	21,000 (6.2)
SEER (Rated)			16.0	17.5
EER (Rated)	Btu/h-W		10.5	11.1
HSPF (Rated)			9.2	9.1
Indoor unit			FBQ30PVJU	FBQ36PVJU
Casing color			Galvanized steel plate	Galvanized steel plate
Dimensions: (H×W×D)		in (mm)	11-13/16 × 39-3/8 × 27-9/16 (300 × 1,000 × 700)	11-13/16 × 55-1/8 × 27-9/16 (300 × 1,400 × 700)
Coil	Type		Cross fin coil	Cross fin coil
	Rows×Stages×FPI		3 × 16 × 15	3 × 16 × 15
	Face area	ft ² (m ²)	2.68 (0.249)	4.12 (0.383)
Fan	Model		—	—
	Type		Sirocco fan	Sirocco fan
	Motor output	W	350	350
	Airflow rate (HH/H/L)	cfm (m ³ /min)	882/794/706 (25.0/22.0/20.0)	1,130/953/812 (32.0/27.0/23.0)
	External static pressure	inH ₂ O (Pa)	Standard 0.40 <0.80-0.20> (100 <200-50>) ★5	Standard 0.40 <0.80-0.20> (100 <200-50>) ★5
Sound pressure level (HH/H/L)	dB(A)		43.0/41.0/39.0	43.0/41.0/39.0
Air filter			—★6	—★6
Weight	lbs (kg)		80 (36)	102 (46)
Connecting Pipes	Liquid Pipe	in (mm)	φ3/8 (φ9.5) (Flare connection)	φ3/8 (φ9.5) (Flare connection)
	Gas Pipe	in (mm)	φ5/8 (φ15.9) (Flare connection)	φ5/8 (φ15.9) (Flare connection)
	Drain Pipe	in (mm)	VP25 (External dia. 1-1/4 (32), internal dia. 1 (26))	VP25 (External dia. 1-1/4 (32), internal dia. 1 (26))
Remote controller (option)	Wired		BRC1E73, BRC2A71	BRC1E73, BRC2A71
	Wireless		BRC4C82, BRC082A43	BRC4C82, BRC082A43
Outdoor unit			RZQ30TAVJUA	RZQ36TAVJUA
Casing color			Ivory white	Ivory white
Dimensions: (H×W×D)		in (mm)	52-15/16 × 35-7/16 × 12-5/8 (1,345 × 900 × 320)	52-15/16 × 35-7/16 × 12-5/8 (1,345 × 900 × 320)
Coil	Type		Cross fin coil	Cross fin coil
	Rows×Stages×FPI		2 × 60 × 19	2 × 60 × 19
	Face area	ft ² (m ²)	12.2 (1.134)	12.2 (1.134)
Compressor	Model		2YC90FXD#A	2YC90FXD#A
	Type		Hermetically sealed swing type	Hermetically sealed swing type
	Motor output	kW	3.5	3.5
Fan	Model		P47N	P47N
	Type		Propeller fan	Propeller fan
	Motor output	W	70 × 2	70 × 2
	Airflow rate	cfm (m ³ /min)	3,741 (106)	3,741 (106)
Weight	lbs (kg)		225 (102)	225 (102)
Sound pressure level (Cooling/Heating)	dB(A)		57 / 59	57 / 59
Connecting Pipes	Liquid Pipe	in (mm)	φ3/8 (φ9.5) (Flare connection)	φ3/8 (φ9.5) (Flare connection)
	Gas Pipe	in (mm)	φ5/8 (φ15.9) (Flare connection)	φ5/8 (φ15.9) (Flare connection)
	Drain Pipe	in (mm)	φ1 (φ26) (Hole)	φ1 (φ26) (Hole)
Safety devices			High pressure switch, Outdoor fan driver overload protector, Inverter overload protector, Fusible plugs, Fuse	High pressure switch, Outdoor fan driver overload protector, Inverter overload protector, Fusible plugs, Fuse
Capacity Control	%		14-100	14-100
Refrigerant control			Electronic expansion valve	Electronic expansion valve
Ref. piping	Standard length	ft (m)	25 (7.6)	25 (7.6)
	Max. length	ft (m)	230 (70)	230 (70)
	Max. height difference	ft (m)	98 (30)	98 (30)
Refrigerant	Model		R-410A	R-410A
	Charge	lbs (kg)	7.9 (3.6)	7.9 (3.6)
Ref. oil	Model		DAPHNE FVC50K	DAPHNE FVC50K
	Charge	L	1.52	1.52
Drawing No.	Specification		C: 4D126352	C: 4D126352
	Sound (indoor)		C: 4D075280	C: 4D075281
	Sound (outdoor)		C: 4D101949D / C: 4D101950E	C: 4D101949D / C: 4D101950E

Notes:

- ★1 Indoor temp.: 80°FDB (26.7°CDB), 67°FWB (19.4°CWB) / Outdoor temp.: 95°FDB (35.0°CDB) / Equivalent piping length: 25 ft (7.6 m), level difference: 0 ft (0 m).
- ★2 Indoor temp.: 70°FDB (21.1°CDB) / Outdoor temp.: 47°FDB (8.3°CDB), 43°FWB (6.1°CWB) / Equivalent piping length: 25 ft (7.6 m), level difference: 0 ft (0 m).
- ★3 Indoor temp.: 70°FDB (21.1°CDB) / Outdoor temp.: 17°FDB (-8.3°CDB), 15°FWB (-9.4°CWB) / Equivalent piping length: 25 ft (7.6 m), level difference: 0 ft (0 m).
- ★4 Capacities are net, including a deduction for cooling (an addition for heating) for indoor fan motor heat.
- ★5 External static pressure is changeable in 14 stages within the < > range by remote controller.
- ★6 Air filter is not standard accessory, but please mount it in the duct system of the suction side. Select its dust collection efficiency (gravity method) 50% or more.

Model name		Indoor unit	FBQ42PVJU	FBQ48PVJU
		Outdoor unit	RZQ42TAVJUA	RZQ48TAVJUA
Power supply			1 phase, 208/230 V, 60 Hz	1 phase, 208/230 V, 60 Hz
★1 ★4 Cooling capacity	Btu/h (kW)		40,500 (11.9)	48,000 (14.1)
★2 ★4 Heating capacity	Btu/h (kW)		47,000 (13.8)	54,000 (15.8)
★3 ★4 Heating capacity	Btu/h (kW)		25,000 (7.3)	28,000 (8.2)
SEER (Rated)			16.0	14.0
EER (Rated)		Btu/h-W	10.1	8.6
HSPF (Rated)			8.8	8.4
Indoor unit			FBQ42PVJU	FBQ48PVJU
Casing color			Galvanized steel plate	Galvanized steel plate
Dimensions: (H×W×D)		in (mm)	11-13/16 × 55-1/8 × 27-9/16 (300 × 1,400 × 700)	11-13/16 × 55-1/8 × 27-9/16 (300 × 1,400 × 700)
Coil	Type		Cross fin coil	Cross fin coil
	Rows×Stages×FPI		3 × 16 × 15	3 × 16 × 15
	Face area	ft ² (m ²)	4.12 (0.383)	4.12 (0.383)
Fan	Model		—	—
	Type		Sirocco fan	Sirocco fan
	Motor output	W	350	350
	Airflow rate (HH/H/L)	cfm (m ³ /min)	1,400/1,165/988 (39.6/33.0/28.0)	1,400/1,165/988 (39.6/33.0/28.0)
	External static pressure	inH ₂ O (Pa)	Standard 0.40 <0.80-0.20> (100 <200-50>) ★5	Standard 0.40 <0.80-0.20> (100 <200-50>) ★5
Sound pressure level (HH/H/L)		dB(A)	44.0/42.0/40.0	44.0/42.0/40.0
Air filter			—★6	—★6
Weight		lbs (kg)	102 (46)	102 (46)
Connecting Pipes	Liquid Pipe	in (mm)	φ3/8 (φ9.5) (Flare connection)	φ3/8 (φ9.5) (Flare connection)
	Gas Pipe	in (mm)	φ5/8 (φ15.9) (Flare connection)	φ5/8 (φ15.9) (Flare connection)
	Drain Pipe	in (mm)	VP25 (External dia. 1-1/4 (32), internal dia. 1 (26))	VP25 (External dia. 1-1/4 (32), internal dia. 1 (26))
Remote controller (option)	Wired		BRC1E73, BRC2A71	BRC1E73, BRC2A71
	Wireless		BRC4C82, BRC082A43	BRC4C82, BRC082A43
Outdoor unit			RZQ42TAVJUA	RZQ48TAVJUA
Casing color			Ivory white	Ivory white
Dimensions: (H×W×D)		in (mm)	52-15/16 × 35-7/16 × 12-5/8 (1,345 × 900 × 320)	52-15/16 × 35-7/16 × 12-5/8 (1,345 × 900 × 320)
Coil	Type		Cross fin coil	Cross fin coil
	Rows×Stages×FPI		2 × 60 × 19	2 × 60 × 19
	Face area	ft ² (m ²)	12.2 (1.134)	12.2 (1.134)
Compressor	Model		2YC90FXD#A	2YC90FXD#A
	Type		Hermetically sealed swing type	Hermetically sealed swing type
	Motor output	kW	3.5	3.5
Fan	Model		P47N	P47N
	Type		Propeller fan	Propeller fan
	Motor output	W	70 × 2	70 × 2
	Airflow rate	cfm (m ³ /min)	3,741 (106)	3,741 (106)
Weight		lbs (kg)	225 (102)	225 (102)
Sound pressure level (Cooling/Heating)		dB(A)	57 / 59	57 / 59
Connecting Pipes	Liquid Pipe	in (mm)	φ3/8 (φ9.5) (Flare connection)	φ3/8 (φ9.5) (Flare connection)
	Gas Pipe	in (mm)	φ5/8 (φ15.9) (Flare connection)	φ5/8 (φ15.9) (Flare connection)
	Drain Pipe	in (mm)	φ1 (φ26) (Hole)	φ1 (φ26) (Hole)
Safety devices			High pressure switch, Outdoor fan driver overload protector, Inverter overload protector, Fusible plugs, Fuse	High pressure switch, Outdoor fan driver overload protector, Inverter overload protector, Fusible plugs, Fuse
Capacity Control		%	14-100	14-100
Refrigerant control			Electronic expansion valve	Electronic expansion valve
Ref. piping	Standard length	ft (m)	25 (7.6)	25 (7.6)
	Max. length	ft (m)	230 (70)	230 (70)
	Max. height difference	ft (m)	98 (30)	98 (30)
Refrigerant	Model		R-410A	R-410A
	Charge	lbs (kg)	7.9 (3.6)	7.9 (3.6)
Ref. oil	Model		DAPHNE FVC50K	DAPHNE FVC50K
	Charge	L	1.52	1.52
Drawing No.	Specification		C: 4D126352	C: 4D126352
	Sound (indoor)		C: 4D075282A	C: 4D075282A
	Sound (outdoor)		C: 4D101949D / C: 4D101950E	C: 4D101949D / C: 4D101950E

Notes:

- ★1 Indoor temp.: 80°FDB (26.7°CDB), 67°FWB (19.4°CWB) / Outdoor temp.: 95°FDB (35.0°CDB) / Equivalent piping length: 25 ft (7.6 m), level difference: 0 ft (0 m).
★2 Indoor temp.: 70°FDB (21.1°CDB) / Outdoor temp.: 47°FDB (8.3°CDB), 43°FWB (6.1°CWB) / Equivalent piping length: 25 ft (7.6 m), level difference: 0 ft (0 m).
★3 Indoor temp.: 70°FDB (21.1°CDB) / Outdoor temp.: 17°FDB (-8.3°CDB), 15°FWB (-9.4°CWB) / Equivalent piping length: 25 ft (7.6 m), level difference: 0 ft (0 m).
★4 Capacities are net, including a deduction for cooling (an addition for heating) for indoor fan motor heat.
★5 External static pressure is changeable in 14 stages within the < > range by remote controller.
★6 Air filter is not standard accessory, but please mount it in the duct system of the suction side. Select its dust collection efficiency (gravity method) 50% or more.

Model name		Indoor unit	Outdoor unit	FBQ18TBVJU RZQ18TBVJUA	FBQ24TBVJU RZQ24TBVJUA
Power supply				1 phase, 208/230 V, 60 Hz	1 phase, 208/230 V, 60 Hz
★1 ★4 Cooling capacity	Btu/h (kW)			17,700 (5.2)	23,400 (6.9)
★2 ★4 Heating capacity	Btu/h (kW)			20,600 (6.0)	27,400 (8.0)
★3 ★4 Heating capacity	Btu/h (kW)			14,000 (4.1)	19,000 (5.6)
Indoor unit				FBQ18TBVJU	FBQ24TBVJU
Casing color				Galvanized steel plate	Galvanized steel plate
Dimensions: (H×W×D)		in (mm)		9-11/16 × 39-3/8 × 31-1/2 (245 × 1,000 × 800)	9-11/16 × 39-3/8 × 31-1/2 (245 × 1,000 × 800)
Coil	Type			Cross fin coil	Cross fin coil
Fan	Type			Sirocco fan	Sirocco fan
	Motor output	W		230	230
	Airflow rate (HH/H/L)	cfm (m ³ /min)		635/565/512 (18.0/16.0/14.5)	742/635/565 (21.0/18.0/16.0)
	External static pressure	inH ₂ O (Pa)		Standard 0.40 <0.80-0.20> (100 <200-50>) ★5	Standard 0.40 <0.80-0.20> (100 <200-50>) ★5
Sound pressure level (HH/H/L)	dB(A)		38.0/35.0/32.0	39.0/35.0/33.0	
Air filter			—★6	—★6	
Weight	lbs (kg)		77 (35)	82 (37)	
Connecting Pipes	Liquid Pipe	in (mm)		φ3/8 (φ9.5) (Flare connection)	φ3/8 (φ9.5) (Flare connection)
	Gas Pipe	in (mm)		φ5/8 (φ15.9) (Flare connection)	φ5/8 (φ15.9) (Flare connection)
	Drain Pipe	in (mm)		VP25 (External dia. 1-1/4 (32), internal dia. 1 (26))	VP25 (External dia. 1-1/4 (32), internal dia. 1 (26))
Remote controller (accessory)	Wired			BRC1E73, BRC1H71W	BRC1E73, BRC1H71W
	Wireless			BRC082A43	BRC082A43
Outdoor unit				RZQ18TBVJUA	RZQ24TBVJUA
Casing color				Ivory white	Ivory white
Dimensions: (H×W×D)		in (mm)		39 × 37 × 12-5/8 (990 × 940 × 320)	39 × 37 × 12-5/8 (990 × 940 × 320)
Coil	Type			Cross fin coil	Cross fin coil
Compressor	Type			Hermetically sealed swing type	Hermetically sealed swing type
	Motor output	kW		1.9	1.9
Fan	Type			Propeller fan	Propeller fan
	Motor output	W		200	200
	Airflow rate	cfm (m ³ /min)		2,682 (76)	2,682 (76)
Weight	lbs (kg)		172 (78)	172 (78)	
Sound pressure level (Cooling/Heating)	dB(A)		58 / 61	58 / 61	
Connecting Pipes	Liquid Pipe	in (mm)		φ3/8 (φ9.5) (Flare connection)	φ3/8 (φ9.5) (Flare connection)
	Gas Pipe	in (mm)		φ5/8 (φ15.9) (Flare connection)	φ5/8 (φ15.9) (Flare connection)
	Drain Pipe	in (mm)		φ1 (φ26) (Hole)	φ1 (φ26) (Hole)
Safety devices				High pressure switch, Outdoor fan driver overload protector, Inverter overload protector, Fusible plug, Fuse	High pressure switch, Outdoor fan driver overload protector, Inverter overload protector, Fusible plug, Fuse
Capacity step	%		14-100	14-100	
Refrigerant control				Electronic expansion valve	Electronic expansion valve
Ref. piping	Standard length	ft (m)		25 (7.6)	25 (7.6)
	Max. length	ft (m)		164 (50)	164 (50)
	Max. height difference	ft (m)		98 (30)	98 (30)
Refrigerant	Type			R-410A	R-410A
	Charge	lbs (kg)		6.4 (2.9)	6.4 (2.9)
Ref. oil	Type			DAPHNE FVC50K	DAPHNE FVC50K
	Charge	L		1.08	1.08
Drawing No.	Specification			4D143007A	4D143007A
	Sound (indoor)			4D143354	4D143355
	Sound (outdoor)			4D101947D / 4D101948E	4D101947D / 4D101948E

Notes:

- ★1 Indoor temp.: 80°FDB (26.7°CDB), 67°FWB (19.4°CWB) / Outdoor temp.: 95°FDB (35.0°CDB) / Equivalent piping length: 25 ft (7.6 m), height difference: 0 ft (0 m).
- ★2 Indoor temp.: 70°FDB (21.1°CDB) / Outdoor temp.: 47°FDB (8.3°CDB), 43°FWB (6.1°CWB) / Equivalent piping length: 25 ft (7.6 m), height difference: 0 ft (0 m).
- ★3 Indoor temp.: 70°FDB (21.1°CDB) / Outdoor temp.: 17°FDB (-8.3°CDB), 15°FWB (-9.4°CWB) / Equivalent piping length: 25 ft (7.6 m), height difference: 0 ft (0 m).
- ★4 Capacities are net, including a deduction for cooling (an addition for heating) for indoor fan motor heat.
- ★5 External static pressure is changeable in 14 stages within the < > range by remote controller.
- ★6 Air filter is not standard accessory, but please mount it in the duct system of the suction side. Select its dust collection efficiency (gravity method) 50% or more.

Model name		Indoor unit		FBQ30TBVJU		FBQ36TBVJU	
		Outdoor unit		RZQ30TBVJUA		RZQ36TBVJUA	
Power supply				1 phase, 208/230 V, 60 Hz		1 phase, 208/230 V, 60 Hz	
★1 ★4 Cooling capacity	Btu/h (kW)	28,400 (8.3)		35,000 (10.3)			
★2 ★4 Heating capacity	Btu/h (kW)	34,800 (10.2)		40,000 (11.7)			
★3 ★4 Heating capacity	Btu/h (kW)	24,000 (7.0)		28,000 (8.2)			
Indoor unit				FBQ30TBVJU		FBQ36TBVJU	
Casing color				Galvanized steel plate		Galvanized steel plate	
Dimensions: (H×W×D)		in (mm)		9-11/16 × 55-1/8 × 31-1/2 (245 × 1,400 × 800)		9-11/16 × 55-1/8 × 31-1/2 (245 × 1,400 × 800)	
Coil	Type	Cross fin coil		Cross fin coil			
Fan	Type	Sirocco fan		Sirocco fan			
	Motor output	W		364			
	Airflow rate (HH/H/L)	cfm (m ³ /min)		1,094/847/795 (31.0/24.0/22.5)		1,130/953/795 (32.0/27.0/22.5)	
	External static pressure	inH ₂ O (Pa)		Standard 0.40 <0.80-0.20> (100 <200-50>) ★5		Standard 0.40 <0.80-0.20> (100 <200-50>) ★5	
Sound pressure level (HH/H/L)		dB(A)		43.0/38.0/36.0		44.0/40.0/36.0	
Air filter				—★6		—★6	
Weight		lbs (kg)		101 (46)		101 (46)	
Connecting Pipes	Liquid Pipe	in (mm)		φ3/8 (φ9.5) (Flare connection)		φ3/8 (φ9.5) (Flare connection)	
	Gas Pipe	in (mm)		φ5/8 (φ15.9) (Flare connection)		φ5/8 (φ15.9) (Flare connection)	
	Drain Pipe	in (mm)		VP25 (External dia. 1-1/4 (32), internal dia. 1 (26))		VP25 (External dia. 1-1/4 (32), internal dia. 1 (26))	
Remote controller (accessory)	Wired	BRC1E73, BRC1H71W		BRC1E73, BRC1H71W			
	Wireless	BRC082A43		BRC082A43			
Outdoor unit				RZQ30TBVJUA		RZQ36TBVJUA	
Casing color				Ivory white		Ivory white	
Dimensions: (H×W×D)		in (mm)		52-15/16 × 35-7/16 × 12-5/8 (1,345 × 900 × 320)		52-15/16 × 35-7/16 × 12-5/8 (1,345 × 900 × 320)	
Coil	Type	Cross fin coil		Cross fin coil			
Compressor	Type	Hermetically sealed swing type		Hermetically sealed swing type			
	Motor output	kW		3.5			
Fan	Type	Propeller fan		Propeller fan			
	Motor output	W		70 × 2			
	Airflow rate	cfm (m ³ /min)		3,741 (106)		3,741 (106)	
Weight		lbs (kg)		225 (102)		225 (102)	
Sound pressure level (Cooling/Heating)		dB(A)		57 / 59		57 / 59	
Connecting Pipes	Liquid Pipe	in (mm)		φ3/8 (φ9.5) (Flare connection)		φ3/8 (φ9.5) (Flare connection)	
	Gas Pipe	in (mm)		φ5/8 (φ15.9) (Flare connection)		φ5/8 (φ15.9) (Flare connection)	
	Drain Pipe	in (mm)		φ1 (φ26) (Hole)		φ1 (φ26) (Hole)	
Safety devices				High pressure switch, Outdoor fan driver overload protector, Inverter overload protector, Fusible plug, Fuse		High pressure switch, Outdoor fan driver overload protector, Inverter overload protector, Fusible plug, Fuse	
Capacity step		%		14-100		14-100	
Refrigerant control				Electronic expansion valve		Electronic expansion valve	
Ref. piping	Standard length	ft (m)		25 (7.6)		25 (7.6)	
	Max. length	ft (m)		230 (70)		230 (70)	
	Max. height difference	ft (m)		98 (30)		98 (30)	
Refrigerant	Type	R-410A		R-410A			
	Charge	lbs (kg)		7.9 (3.6)		7.9 (3.6)	
Ref. oil	Type	DAPHNE FVC50K		DAPHNE FVC50K			
	Charge	L		1.52			
Drawing No.	Specification	4D143008A		4D143008A			
	Sound (indoor)	4D143356		4D143357			
	Sound (outdoor)	4D101949D / 4D101950E		4D101949D / 4D101950E			

Notes:

★1 Indoor temp.: 80°FDB (26.7°CDB), 67°FWB (19.4°CWB) / Outdoor temp.: 95°FDB (35.0°CDB) / Equivalent piping length: 25 ft (7.6 m), height difference: 0 ft (0 m).

★2 Indoor temp.: 70°FDB (21.1°CDB) / Outdoor temp.: 47°FDB (8.3°CDB), 43°FWB (6.1°CWB) / Equivalent piping length: 25 ft (7.6 m), height difference: 0 ft (0 m).

★3 Indoor temp.: 70°FDB (21.1°CDB) / Outdoor temp.: 17°FDB (-8.3°CDB), 15°FWB (-9.4°CWB) / Equivalent piping length: 25 ft (7.6 m), height difference: 0 ft (0 m).

★4 Capacities are net, including a deduction for cooling (an addition for heating) for indoor fan motor heat.

★5 External static pressure is changeable in 14 stages within the < > range by remote controller.

★6 Air filter is not standard accessory, but please mount it in the duct system of the suction side. Select its dust collection efficiency (gravity method) 50% or more.

Model name		Indoor unit	Outdoor unit	FBQ42TBVJU RZQ42TBVJUA	FBQ48TBVJU RZQ48TBVJUA
Power supply				1 phase, 208/230 V, 60 Hz	1 phase, 208/230 V, 60 Hz
★1 ★4 Cooling capacity	Btu/h (kW)			40,000 (11.7)	46,500 (13.6)
★2 ★4 Heating capacity	Btu/h (kW)			47,000 (13.8)	54,000 (15.8)
★3 ★4 Heating capacity	Btu/h (kW)			32,400 (9.5)	38,000 (11.1)
Indoor unit				FBQ42TBVJU	FBQ48TBVJU
Casing color				Galvanized steel plate	Galvanized steel plate
Dimensions: (H×W×D)		in (mm)		9-11/16 × 55-1/8 × 31-1/2 (245 × 1,400 × 800)	9-11/16 × 55-1/8 × 31-1/2 (245 × 1,400 × 800)
Coil	Type			Cross fin coil	Cross fin coil
Fan	Type			Sirocco fan	Sirocco fan
	Motor output	W		364	364
	Airflow rate (HH/H/L)	cfm (m ³ /min)		1,377/1,130/918 (39.0/32.0/26.0)	1,377/1,130/918 (39.0/32.0/26.0)
	External static pressure	inH ₂ O (Pa)		Standard 0.40 <0.80-0.20> (100 <200-50>) ★5	Standard 0.40 <0.80-0.20> (100 <200-50>) ★5
Sound pressure level (HH/H/L)		dB(A)		48.0/44.0/39.0	48.0/44.0/39.0
Air filter				—★6	—★6
Weight		lbs (kg)		104 (47)	104 (47)
Connecting Pipes	Liquid Pipe	in (mm)		φ3/8 (φ9.5) (Flare connection)	φ3/8 (φ9.5) (Flare connection)
	Gas Pipe	in (mm)		φ5/8 (φ15.9) (Flare connection)	φ5/8 (φ15.9) (Flare connection)
	Drain Pipe	in (mm)		VP25 (External dia. 1-1/4 (32), internal dia. 1 (26))	VP25 (External dia. 1-1/4 (32), internal dia. 1 (26))
Remote controller (accessory)	Wired			BRC1E73, BRC1H71W	BRC1E73, BRC1H71W
	Wireless			BRC082A43	BRC082A43
Outdoor unit				RZQ42TBVJUA	RZQ48TBVJUA
Casing color				Ivory white	Ivory white
Dimensions: (H×W×D)		in (mm)		52-15/16 × 35-7/16 × 12-5/8 (1,345 × 900 × 320)	52-15/16 × 35-7/16 × 12-5/8 (1,345 × 900 × 320)
Coil	Type			Cross fin coil	Cross fin coil
Compressor	Type			Hermetically sealed swing type	Hermetically sealed swing type
	Motor output	kW		3.5	3.5
Fan	Type			Propeller fan	Propeller fan
	Motor output	W		70 × 2	70 × 2
	Airflow rate	cfm (m ³ /min)		3,741 (106)	3,741 (106)
Weight		lbs (kg)		225 (102)	225 (102)
Sound pressure level (Cooling/Heating)		dB(A)		57 / 59	57 / 59
Connecting Pipes	Liquid Pipe	in (mm)		φ3/8 (φ9.5) (Flare connection)	φ3/8 (φ9.5) (Flare connection)
	Gas Pipe	in (mm)		φ5/8 (φ15.9) (Flare connection)	φ5/8 (φ15.9) (Flare connection)
	Drain Pipe	in (mm)		φ1 (φ26) (Hole)	φ1 (φ26) (Hole)
Safety devices				High pressure switch, Outdoor fan driver overload protector, Inverter overload protector, Fusible plug, Fuse	High pressure switch, Outdoor fan driver overload protector, Inverter overload protector, Fusible plug, Fuse
Capacity step		%		14-100	14-100
Refrigerant control				Electronic expansion valve	Electronic expansion valve
Ref. piping	Standard length	ft (m)		25 (7.6)	25 (7.6)
	Max. length	ft (m)		230 (70)	230 (70)
	Max. height difference	ft (m)		98 (30)	98 (30)
Refrigerant	Type			R-410A	R-410A
	Charge	lbs (kg)		7.9 (3.6)	7.9 (3.6)
Ref. oil	Type			DAPHNE FVC50K	DAPHNE FVC50K
	Charge	L		1.52	1.52
Drawing No.	Specification			4D143008A	4D143008A
	Sound (indoor)			4D143359	4D143360
	Sound (outdoor)			4D101949D / 4D101950E	4D101949D / 4D101950E

Notes:

- ★1 Indoor temp.: 80°FDB (26.7°CDB), 67°FWB (19.4°CWB) / Outdoor temp.: 95°FDB (35.0°CDB) / Equivalent piping length: 25 ft (7.6 m), height difference: 0 ft (0 m).
- ★2 Indoor temp.: 70°FDB (21.1°CDB) / Outdoor temp.: 47°FDB (8.3°CDB), 43°FWB (6.1°CWB) / Equivalent piping length: 25 ft (7.6 m), height difference: 0 ft (0 m).
- ★3 Indoor temp.: 70°FDB (21.1°CDB) / Outdoor temp.: 17°FDB (-8.3°CDB), 15°FWB (-9.4°CWB) / Equivalent piping length: 25 ft (7.6 m), height difference: 0 ft (0 m).
- ★4 Capacities are net, including a deduction for cooling (an addition for heating) for indoor fan motor heat.
- ★5 External static pressure is changeable in 14 stages within the < > range by remote controller.
- ★6 Air filter is not standard accessory, but please mount it in the duct system of the suction side. Select its dust collection efficiency (gravity method) 50% or more.

3.2.5 Multi Position Air Handling Unit

Model name		Indoor unit	FTQ18TAVJUD, FTQ18TAVJUA		FTQ24TAVJUD, FTQ24TAVJUA	
		Outdoor unit	RZQ18TAVJU		RZQ24TAVJU	
Power supply		1 phase, 208/230 V, 60 Hz		1 phase, 208/230 V, 60 Hz		
★1 ★4 Cooling capacity	Btu/h (kW)	18,000 (5.3)		24,000 (7.0)		
★2 ★4 Heating capacity	Btu/h (kW)	20,000 (5.9)		27,000 (7.9)		
★3 ★4 Heating capacity	Btu/h (kW)	13,000 (3.8)		18,000 (5.3)		
SEER (Rated)		15.5		15.2		
EER (Rated)		12.5		10.3		
HSPF (Rated)		8.6		9.4		
Indoor unit		FTQ18TAVJUD, FTQ18TAVJUA		FTQ24TAVJUD, FTQ24TAVJUA		
Casing color		Daikin Slate Gray		Daikin Slate Gray		
Dimensions: (H×W×D)		in (mm)		45 × 17.5 × 21 (1,143 × 445 × 533)		
Coil	Type	Cross fin coil		Cross fin coil		
	Face area	ft ² (m ²)		3.75 (35)		
Fan	Type	Sirocco FC Centrifugal		Sirocco FC Centrifugal		
	Motor output	HP		1/2		
	Airflow rate (H/M/L)	cfm (m ³ /min)		600/510/420 (17.0/14.4/11.9)		
	External static pressure	in. w.g.		0.1" - 0.9"		
Sound pressure level (H/M/L)		dB(A)		44.6/41.3/38.4		
Air filter		—★5		—★5		
Weight		lbs (kg)		115 (52.2)		
Connecting Pipes	Liquid Pipe	in (mm)		φ3/8 (φ9.5) (Brazing connection)		
	Gas Pipe	in (mm)		φ5/8 (φ15.9) (Brazing connection)		
	Drain Pipe	in (mm)		3/4" (19.1)		
Remote controller (option)	Wired	BRC1E73, BRC2A71		BRC1E73, BRC2A71		
	Wireless	BRC4C82		BRC4C82		
Outdoor unit		RZQ18TAVJU		RZQ24TAVJU		
Casing color		Ivory white		Ivory white		
Dimensions: (H×W×D)		in (mm)		39 × 37 × 12-5/8 (990 × 940 × 320)		
Coil	Type	Cross fin coil		Cross fin coil		
	Rows×Stages×FPI	2 × 44 × 19		2 × 44 × 19		
	Face area	ft ² (m ²)		9.5 (0.88)		
Compressor	Model	2YC63ABXDD		2YC63ABXDD		
	Type	Hermetically sealed swing type		Hermetically sealed swing type		
	Motor output	kW		1.9		
Fan	Model	P51J11F		P51J11F		
	Type	Propeller fan		Propeller fan		
	Motor output	W		200		
	Airflow rate	cfm (m ³ /min)		2,682 (76)		
Weight		lbs (kg)		172 (78)		
Sound pressure level (Cooling/Heating)		dB(A)		58 / 61		
Connecting Pipes	Liquid Pipe	in (mm)		φ3/8 (φ9.5) (Flare connection)		
	Gas Pipe	in (mm)		φ5/8 (φ15.9) (Flare connection)		
	Drain Pipe	in (mm)		φ1 (φ26) (Hole)		
Safety devices		High pressure switch, Outdoor fan driver overload protector, Inverter overload protector, Fusible plugs, Fuse		High pressure switch, Outdoor fan driver overload protector, Inverter overload protector, Fusible plugs, Fuse		
Capacity Control		%		14-100		
Refrigerant control		Electronic expansion valve		Electronic expansion valve		
Ref. piping	Standard length	ft (m)		25 (7.6)		
	Max. length	ft (m)		164 (50)		
	Max. height difference	ft (m)		98 (30)		
Refrigerant	Model	R-410A		R-410A		
	Charge	lbs (kg)		6.4 (2.9)		
Ref. oil	Model	DAPHNE FVC50K		DAPHNE FVC50K		
	Charge	L		1.08		
Drawing No.	Sound (outdoor)	C: 4D101947D / C: 4D101948E		C: 4D101947D / C: 4D101948E		
Notes:						
★1 Indoor temp. : 80°FDB (26.7°CDB), 67°FWB (19.4°CWB) / Outdoor temp. : 95°FDB (35.0°CDB) / Equivalent piping length : 25 ft (7.6 m), level difference : 0 ft (0 m).						
★2 Indoor temp. : 70°FDB (21.1°CDB) / Outdoor temp. : 47°FDB (8.3°CDB), 43°FWB (6.1°CWB) / Equivalent piping length : 25 ft (7.6 m), level difference : 0 ft (0 m).						
★3 Indoor temp. : 70°FDB (21.1°CDB) / Outdoor temp. : 17°FDB (-8.3°CDB), 15°FWB (-9.4°CWB) / Equivalent piping length : 25 ft (7.6 m), level difference : 0 ft (0 m).						
★4 Capacities are net, including a deduction for cooling (an addition for heating) for indoor fan motor heat.						
★5 Air filter is not standard accessory (field supply parts), but please mount it in the duct system of the suction side.						

Model name	Indoor unit		FTQ30TAVJUD, FTQ30TAVJUA		FTQ36TAVJUD, FTQ36TAVJUA	
	Outdoor unit		RZQ30TAVJU		RZQ36TAVJU	
Power supply			1 phase, 208/230 V, 60 Hz		1 phase, 208/230 V, 60 Hz	
★1 ★4 Cooling capacity	Btu/h (kW)		30,000 (8.8)		36,000 (10.6)	
★2 ★4 Heating capacity	Btu/h (kW)		34,000 (10.0)		40,000 (11.7)	
★3 ★4 Heating capacity	Btu/h (kW)		22,000 (6.4)		26,000 (7.6)	
SEER (Rated)			16.0		15.3	
EER (Rated)			12.5		11.3	
HSPF (Rated)			10.4		9.5	
Indoor unit			FTQ30TAVJUD, FTQ30TAVJUA		FTQ36TAVJUD, FTQ36TAVJUA	
Casing color			Daikin Slate Gray		Daikin Slate Gray	
Dimensions: (H×W×D)			45 × 17.5 × 21 (1,143 × 445 × 533)		45 × 17.5 × 21 (1,143 × 445 × 533)	
Coil	Type		Cross fin coil		Cross fin coil	
	Face area	ft ² (m ²)	3.75 (35)		3.75 (35)	
Fan	Type		Sirocco FC Centrifugal		Sirocco FC Centrifugal	
	Motor output	HP	1/2		1/2	
	Airflow rate (H/M/L)	cfm (m ³ /min)	1,000/850/700 (28.3/24.1/19.8)		1,050/900/750 (29.7/25.5/21.2)	
	External static pressure	in. w.g.	0.1" - 0.9"		0.1" - 0.9"	
Sound pressure level (H/M/L)			51.6/48.2/44.0		51.6/48.2/44.0	
Air filter			—★5		—★5	
Weight			115 (52.2)		140 (63.5)	
Connecting Pipes	Liquid Pipe	in (mm)	φ3/8 (φ9.5) (Brazing connection)		φ3/8 (φ9.5) (Brazing connection)	
	Gas Pipe	in (mm)	φ5/8 (φ15.9) (Brazing connection)		φ5/8 (φ15.9) (Brazing connection)	
	Drain Pipe	in (mm)	3/4" (19.1)		3/4" (19.1)	
Remote controller (option)	Wired		BRC1E73, BRC2A71		BRC1E73, BRC2A71	
	Wireless		BRC4C82		BRC4C82	
Outdoor unit			RZQ30TAVJU		RZQ36TAVJU	
Casing color			Ivory white		Ivory white	
Dimensions: (H×W×D)			52-15/16 × 35-7/16 × 12-5/8 (1,345 × 900 × 320)		52-15/16 × 35-7/16 × 12-5/8 (1,345 × 900 × 320)	
Coil	Type		Cross fin coil		Cross fin coil	
	Rows×Stages×FPI		2 × 60 × 19		2 × 60 × 19	
	Face area	ft ² (m ²)	12.2 (1.134)		12.2 (1.134)	
Compressor	Model		2YC90GXD#D		2YC90GXD#D	
	Type		Hermetically sealed swing type		Hermetically sealed swing type	
	Motor output	kW	3.5		3.5	
Fan	Model		P47N		P47N	
	Type		Propeller fan		Propeller fan	
	Motor output	W	70 × 2		70 × 2	
	Airflow rate	cfm (m ³ /min)	3,741 (106)		3,741 (106)	
Weight			225 (102)		225 (102)	
Sound pressure level (Cooling/Heating)			57 / 59		57 / 59	
Connecting Pipes	Liquid Pipe	in (mm)	φ3/8 (φ9.5) (Flare connection)		φ3/8 (φ9.5) (Flare connection)	
	Gas Pipe	in (mm)	φ5/8 (φ15.9) (Flare connection)		φ5/8 (φ15.9) (Flare connection)	
	Drain Pipe	in (mm)	φ1 (φ26) (Hole)		φ1 (φ26) (Hole)	
Safety devices			High pressure switch, Outdoor fan driver overload protector, Inverter overload protector, Fusible plugs, Fuse		High pressure switch, Outdoor fan driver overload protector, Inverter overload protector, Fusible plugs, Fuse	
Capacity Control			14-100		14-100	
Refrigerant control			Electronic expansion valve		Electronic expansion valve	
Ref. piping	Standard length	ft (m)	25 (7.6)		25 (7.6)	
	Max. length	ft (m)	230 (70)		230 (70)	
	Max. height difference	ft (m)	98 (30)		98 (30)	
Refrigerant	Model		R-410A		R-410A	
	Charge	lbs (kg)	7.9 (3.6)		7.9 (3.6)	
Ref. oil	Model		DAPHNE FVC50K		DAPHNE FVC50K	
	Charge	L	1.52		1.52	
Drawing No.	Sound (outdoor)		C: 4D101949D / C: 4D101950E		C: 4D101949D / C: 4D101950E	

Notes:

- ★1 Indoor temp.: 80°FDB (26.7°CDB), 67°FWB (19.4°CWB) / Outdoor temp.: 95°FDB (35.0°CDB) / Equivalent piping length: 25 ft (7.6 m), level difference: 0 ft (0 m).
- ★2 Indoor temp.: 70°FDB (21.1°CDB) / Outdoor temp.: 47°FDB (8.3°CDB), 43°FWB (6.1°CWB) / Equivalent piping length: 25 ft (7.6 m), level difference: 0 ft (0 m).
- ★3 Indoor temp.: 70°FDB (21.1°CDB) / Outdoor temp.: 17°FDB (-8.3°CDB), 15°FWB (-9.4°CWB) / Equivalent piping length: 25 ft (7.6 m), level difference: 0 ft (0 m).
- ★4 Capacities are net, including a deduction for cooling (an addition for heating) for indoor fan motor heat.
- ★5 Air filter is not standard accessory (field supply parts), but please mount it in the duct system of the suction side.

Model name	Indoor unit		FTQ42TAVJUD, FTQ42TAVJUA		FTQ48TAVJUD, FTQ48TAVJUA	
	Outdoor unit		RZQ42TAVJU		RZQ48TAVJU	
Power supply			1 phase, 208/230 V, 60 Hz		1 phase, 208/230 V, 60 Hz	
★1 ★4 Cooling capacity	Btu/h (kW)		42,000 (12.3)		48,000 (14.1)	
★2 ★4 Heating capacity	Btu/h (kW)		47,000 (13.8)		54,000 (15.8)	
★3 ★4 Heating capacity	Btu/h (kW)		31,000 (9.1)		32,000 (9.4)	
SEER (Rated)			16.0		14.8	
EER (Rated)			11.0		9.5	
HSPF (Rated)			9.0		9.0	
Indoor unit			FTQ42TAVJUD, FTQ42TAVJUA		FTQ48TAVJUD, FTQ48TAVJUA	
Casing color			Daikin Slate Gray		Daikin Slate Gray	
Dimensions: (H×W×D)			53.43 × 21 × 21 (1,357 × 533 × 533)		53.43 × 21 × 21 (1,357 × 533 × 533)	
Coil	Type		Cross fin coil		Cross fin coil	
	Face area	ft ² (m ²)	5.15 (48)		5.15 (48)	
Fan	Type		Sirocco FC Centrifugal		Sirocco FC Centrifugal	
	Motor output	HP	3/4		3/4	
	Airflow rate (H/M/L)	cfm (m ³ /min)	1,400/1,190/980 (39.7/33.7/27.8)		1,520/1,290/1,060 (43.1/36.5/30.0)	
	External static pressure	in. w.g.	0.1" - 0.9"		0.1" - 0.9"	
Sound pressure level (H/M/L)			53.8/50.0/45.6		53.8/50.0/45.6	
Air filter			—★5		—★5	
Weight			150 (68)		150 (68)	
Connecting Pipes	Liquid Pipe	in (mm)	φ3/8 (φ9.5) (Brazing connection)		φ3/8 (φ9.5) (Brazing connection)	
	Gas Pipe	in (mm)	φ5/8 (φ15.9) (Brazing connection)		φ5/8 (φ15.9) (Brazing connection)	
	Drain Pipe	in (mm)	3/4" (19.1)		3/4" (19.1)	
Remote controller (option)	Wired		BRC1E73, BRC2A71		BRC1E73, BRC2A71	
	Wireless		BRC4C82		BRC4C82	
Outdoor unit			RZQ42TAVJU		RZQ48TAVJU	
Casing color			Ivory white		Ivory white	
Dimensions: (H×W×D)			52-15/16 × 35-7/16 × 12-5/8 (1,345 × 900 × 320)		52-15/16 × 35-7/16 × 12-5/8 (1,345 × 900 × 320)	
Coil	Type		Cross fin coil		Cross fin coil	
	Rows×Stages×FPI		2 × 60 × 19		2 × 60 × 19	
	Face area	ft ² (m ²)	12.2 (1.134)		12.2 (1.134)	
Compressor	Model		2YC90GXD#D		2YC90GXD#D	
	Type		Hermetically sealed swing type		Hermetically sealed swing type	
	Motor output	kW	3.5		3.5	
Fan	Model		P47N		P47N	
	Type		Propeller fan		Propeller fan	
	Motor output	W	70 × 2		70 × 2	
	Airflow rate	cfm (m ³ /min)	3,741 (106)		3,741 (106)	
Weight			225 (102)		225 (102)	
Sound pressure level (Cooling/Heating)			57 / 59		57 / 59	
Connecting Pipes	Liquid Pipe	in (mm)	φ3/8 (φ9.5) (Flare connection)		φ3/8 (φ9.5) (Flare connection)	
	Gas Pipe	in (mm)	φ5/8 (φ15.9) (Flare connection)		φ5/8 (φ15.9) (Flare connection)	
	Drain Pipe	in (mm)	φ1 (φ26) (Hole)		φ1 (φ26) (Hole)	
Safety devices			High pressure switch, Outdoor fan driver overload protector, Inverter overload protector, Fusible plugs, Fuse		High pressure switch, Outdoor fan driver overload protector, Inverter overload protector, Fusible plugs, Fuse	
Capacity Control			14-100		14-100	
Refrigerant control			Electronic expansion valve		Electronic expansion valve	
Ref. piping	Standard length	ft (m)	25 (7.6)		25 (7.6)	
	Max. length	ft (m)	230 (70)		230 (70)	
	Max. height difference	ft (m)	98 (30)		98 (30)	
Refrigerant	Model		R-410A		R-410A	
	Charge	lbs (kg)	7.9 (3.6)		7.9 (3.6)	
Ref. oil	Model		DAPHNE FVC50K		DAPHNE FVC50K	
	Charge	L	1.52		1.52	
Drawing No.	Sound (outdoor)		C: 4D101949D / C: 4D101950E		C: 4D101949D / C: 4D101950E	
Notes:						
★1 Indoor temp.: 80°FDB (26.7°CDB), 67°FWB (19.4°CWB) / Outdoor temp.: 95°FDB (35.0°CDB) / Equivalent piping length: 25 ft (7.6 m), level difference: 0 ft (0 m).						
★2 Indoor temp.: 70°FDB (21.1°CDB) / Outdoor temp.: 47°FDB (8.3°CDB), 43°FWB (6.1°CWB) / Equivalent piping length: 25 ft (7.6 m), level difference: 0 ft (0 m).						
★3 Indoor temp.: 70°FDB (21.1°CDB) / Outdoor temp.: 17°FDB (-8.3°CDB), 15°FWB (-9.4°CWB) / Equivalent piping length: 25 ft (7.6 m), level difference: 0 ft (0 m).						
★4 Capacities are net, including a deduction for cooling (an addition for heating) for indoor fan motor heat.						
★5 Air filter is not standard accessory (field supply parts), but please mount it in the duct system of the suction side.						

Model name	Indoor unit		FTQ18TAVJUD, FTQ18TAVJUA		FTQ24TAVJUD, FTQ24TAVJUA	
	Outdoor unit		RZQ18TAVJUA		RZQ24TAVJUA	
Power supply			1 phase, 208/230 V, 60 Hz		1 phase, 208/230 V, 60 Hz	
★1 ★4 Cooling capacity	Btu/h (kW)		18,000 (5.3)		24,000 (7.0)	
★2 ★4 Heating capacity	Btu/h (kW)		20,000 (5.9)		27,000 (7.9)	
★3 ★4 Heating capacity	Btu/h (kW)		13,000 (3.8)		18,000 (5.3)	
SEER (Rated)			15.5		15.2	
EER (Rated)			12.5		10.3	
HSPF (Rated)			8.6		9.4	
Indoor unit			FTQ18TAVJUD, FTQ18TAVJUA		FTQ24TAVJUD, FTQ24TAVJUA	
Casing color			Daikin Slate Gray		Daikin Slate Gray	
Dimensions: (H×W×D)			45 × 17.5 × 21 (1,143 × 445 × 533)		45 × 17.5 × 21 (1,143 × 445 × 533)	
Coil	Type		Cross fin coil		Cross fin coil	
	Face area	ft ² (m ²)	3.75 (35)		3.75 (35)	
Fan	Type		Sirocco FC Centrifugal		Sirocco FC Centrifugal	
	Motor output	HP	1/2		1/2	
	Airflow rate (H/M/L)	cfm (m ³ /min)	600/510/420 (17.0/14.4/11.9)		800/680/560 (22.7/19.3/15.9)	
	External static pressure	in. w.g.	0.1" - 0.9"		0.1" - 0.9"	
Sound pressure level (H/M/L)			44.6/41.3/38.4		51.6/48.2/44.0	
Air filter			—★5		—★5	
Weight			115 (52.2)		115 (52.2)	
Connecting Pipes	Liquid Pipe	in (mm)	φ3/8 (φ9.5) (Brazing connection)		φ3/8 (φ9.5) (Brazing connection)	
	Gas Pipe	in (mm)	φ5/8 (φ15.9) (Brazing connection)		φ5/8 (φ15.9) (Brazing connection)	
	Drain Pipe	in (mm)	3/4" (19.1)		3/4" (19.1)	
Remote controller (option)	Wired		BRC1E73, BRC2A71		BRC1E73, BRC2A71	
	Wireless		BRC4C82		BRC4C82	
Outdoor unit			RZQ18TAVJUA		RZQ24TAVJUA	
Casing color			Ivory white		Ivory white	
Dimensions: (H×W×D)			39 × 37 × 12-5/8 (990 × 940 × 320)		39 × 37 × 12-5/8 (990 × 940 × 320)	
Coil	Type		Cross fin coil		Cross fin coil	
	Rows×Stages×FPI		2 × 44 × 19		2 × 44 × 19	
	Face area	ft ² (m ²)	9.5 (0.88)		9.5 (0.88)	
Compressor	Model		2YC63TXD#A		2YC63TXD#A	
	Type		Hermetically sealed swing type		Hermetically sealed swing type	
	Motor output	kW	1.9		1.9	
Fan	Model		P51J11F		P51J11F	
	Type		Propeller fan		Propeller fan	
	Motor output	W	200		200	
	Airflow rate	cfm (m ³ /min)	2,682 (76)		2,682 (76)	
Weight			172 (78)		172 (78)	
Sound pressure level (Cooling/Heating)			58 / 61		58 / 61	
Connecting Pipes	Liquid Pipe	in (mm)	φ3/8 (φ9.5) (Flare connection)		φ3/8 (φ9.5) (Flare connection)	
	Gas Pipe	in (mm)	φ5/8 (φ15.9) (Flare connection)		φ5/8 (φ15.9) (Flare connection)	
	Drain Pipe	in (mm)	φ1 (φ26) (Hole)		φ1 (φ26) (Hole)	
Safety devices			High pressure switch, Outdoor fan driver overload protector, Inverter overload protector, Fusible plugs, Fuse		High pressure switch, Outdoor fan driver overload protector, Inverter overload protector, Fusible plugs, Fuse	
Capacity Control			%		14-100	
Refrigerant control			Electronic expansion valve		Electronic expansion valve	
Ref. piping	Standard length	ft (m)	25 (7.6)		25 (7.6)	
	Max. length	ft (m)	164 (50)		164 (50)	
	Max. height difference	ft (m)	98 (30)		98 (30)	
Refrigerant	Model		R-410A		R-410A	
	Charge	lbs (kg)	6.4 (2.9)		6.4 (2.9)	
Ref. oil	Model		DAPHNE FVC50K		DAPHNE FVC50K	
	Charge	L	1.08		1.08	
Drawing No.	Sound (outdoor)		C: 4D101947D / C: 4D101948E		C: 4D101947D / C: 4D101948E	

Notes:

- ★1 Indoor temp.: 80°FDB (26.7°CDB), 67°FWB (19.4°CWB) / Outdoor temp.: 95°FDB (35.0°CDB) / Equivalent piping length: 25 ft (7.6 m), level difference: 0 ft (0 m).
- ★2 Indoor temp.: 70°FDB (21.1°CDB) / Outdoor temp.: 47°FDB (8.3°CDB), 43°FWB (6.1°CWB) / Equivalent piping length: 25 ft (7.6 m), level difference: 0 ft (0 m).
- ★3 Indoor temp.: 70°FDB (21.1°CDB) / Outdoor temp.: 17°FDB (-8.3°CDB), 15°FWB (-9.4°CWB) / Equivalent piping length: 25 ft (7.6 m), level difference: 0 ft (0 m).
- ★4 Capacities are net, including a deduction for cooling (an addition for heating) for indoor fan motor heat.
- ★5 Air filter is not standard accessory (field supply parts), but please mount it in the duct system of the suction side.

Model name	Indoor unit		FTQ30TAVJUD, FTQ30TAVJUA		FTQ36TAVJUD, FTQ36TAVJUA	
	Outdoor unit		RZQ30TAVJUA		RZQ36TAVJUA	
Power supply			1 phase, 208/230 V, 60 Hz		1 phase, 208/230 V, 60 Hz	
★1 ★4 Cooling capacity	Btu/h (kW)		30,000 (8.8)		36,000 (10.6)	
★2 ★4 Heating capacity	Btu/h (kW)		34,000 (10.0)		40,000 (11.7)	
★3 ★4 Heating capacity	Btu/h (kW)		22,000 (6.4)		26,000 (7.6)	
SEER (Rated)			16.0		15.3	
EER (Rated)			12.5		11.3	
HSPF (Rated)			10.4		9.5	
Indoor unit			FTQ30TAVJUD, FTQ30TAVJUA		FTQ36TAVJUD, FTQ36TAVJUA	
Casing color			Daikin Slate Gray		Daikin Slate Gray	
Dimensions: (H×W×D)			45 × 17.5 × 21 (1,143 × 445 × 533)		45 × 17.5 × 21 (1,143 × 445 × 533)	
Coil	Type		Cross fin coil		Cross fin coil	
	Face area	ft ² (m ²)	3.75 (35)		3.75 (35)	
Fan	Type		Sirocco FC Centrifugal		Sirocco FC Centrifugal	
	Motor output	HP	1/2		1/2	
	Airflow rate (H/M/L)	cfm (m ³ /min)	1,000/850/700 (28.3/24.1/19.8)		1,050/900/750 (29.7/25.5/21.2)	
	External static pressure	in. w.g.	0.1" - 0.9"		0.1" - 0.9"	
Sound pressure level (H/M/L)			51.6/48.2/44.0		51.6/48.2/44.0	
Air filter			—★5		—★5	
Weight			115 (52.2)		140 (63.5)	
Connecting Pipes	Liquid Pipe	in (mm)	φ3/8 (φ9.5) (Brazing connection)		φ3/8 (φ9.5) (Brazing connection)	
	Gas Pipe	in (mm)	φ5/8 (φ15.9) (Brazing connection)		φ5/8 (φ15.9) (Brazing connection)	
	Drain Pipe	in (mm)	3/4" (19.1)		3/4" (19.1)	
Remote controller (option)	Wired		BRC1E73, BRC2A71		BRC1E73, BRC2A71	
	Wireless		BRC4C82		BRC4C82	
Outdoor unit			RZQ30TAVJUA		RZQ36TAVJUA	
Casing color			Ivory white		Ivory white	
Dimensions: (H×W×D)			52-15/16 × 35-7/16 × 12-5/8 (1,345 × 900 × 320)		52-15/16 × 35-7/16 × 12-5/8 (1,345 × 900 × 320)	
Coil	Type		Cross fin coil		Cross fin coil	
	Rows×Stages×FPI		2 × 60 × 19		2 × 60 × 19	
	Face area	ft ² (m ²)	12.2 (1.134)		12.2 (1.134)	
Compressor	Model		2YC90FXD#A		2YC90FXD#A	
	Type		Hermetically sealed swing type		Hermetically sealed swing type	
	Motor output	kW	3.5		3.5	
Fan	Model		P47N		P47N	
	Type		Propeller fan		Propeller fan	
	Motor output	W	70 × 2		70 × 2	
	Airflow rate	cfm (m ³ /min)	3,741 (106)		3,741 (106)	
Weight			225 (102)		225 (102)	
Sound pressure level (Cooling/Heating)			57 / 59		57 / 59	
Connecting Pipes	Liquid Pipe	in (mm)	φ3/8 (φ9.5) (Flare connection)		φ3/8 (φ9.5) (Flare connection)	
	Gas Pipe	in (mm)	φ5/8 (φ15.9) (Flare connection)		φ5/8 (φ15.9) (Flare connection)	
	Drain Pipe	in (mm)	φ1 (φ26) (Hole)		φ1 (φ26) (Hole)	
Safety devices			High pressure switch, Outdoor fan driver overload protector, Inverter overload protector, Fusible plugs, Fuse		High pressure switch, Outdoor fan driver overload protector, Inverter overload protector, Fusible plugs, Fuse	
Capacity Control			14-100		14-100	
Refrigerant control			Electronic expansion valve		Electronic expansion valve	
Ref. piping	Standard length	ft (m)	25 (7.6)		25 (7.6)	
	Max. length	ft (m)	230 (70)		230 (70)	
	Max. height difference	ft (m)	98 (30)		98 (30)	
Refrigerant	Model		R-410A		R-410A	
	Charge	lbs (kg)	7.9 (3.6)		7.9 (3.6)	
Ref. oil	Model		DAPHNE FVC50K		DAPHNE FVC50K	
	Charge	L	1.52		1.52	
Drawing No.	Sound (outdoor)		C: 4D101949D / C: 4D101950E		C: 4D101949D / C: 4D101950E	

Notes:
★1 Indoor temp.: 80°FDB (26.7°CDB), 67°FWB (19.4°CWB) / Outdoor temp.: 95°FDB (35.0°CDB) / Equivalent piping length: 25 ft (7.6 m), level difference: 0 ft (0 m).
★2 Indoor temp.: 70°FDB (21.1°CDB) / Outdoor temp.: 47°FDB (8.3°CDB), 43°FWB (6.1°CWB) / Equivalent piping length: 25 ft (7.6 m), level difference: 0 ft (0 m).
★3 Indoor temp.: 70°FDB (21.1°CDB) / Outdoor temp.: 17°FDB (-8.3°CDB), 15°FWB (-9.4°CWB) / Equivalent piping length: 25 ft (7.6 m), level difference: 0 ft (0 m).
★4 Capacities are net, including a deduction for cooling (an addition for heating) for indoor fan motor heat.
★5 Air filter is not standard accessory (field supply parts), but please mount it in the duct system of the suction side.

Model name	Indoor unit		FTQ42TAVJUD, FTQ42TAVJUA		FTQ48TAVJUD, FTQ48TAVJUA	
	Outdoor unit		RZQ42TAVJUA		RZQ48TAVJUA	
Power supply			1 phase, 208/230 V, 60 Hz		1 phase, 208/230 V, 60 Hz	
★1 ★4 Cooling capacity	Btu/h (kW)		42,000 (12.3)		48,000 (14.1)	
★2 ★4 Heating capacity	Btu/h (kW)		47,000 (13.8)		54,000 (15.8)	
★3 ★4 Heating capacity	Btu/h (kW)		31,000 (9.1)		32,000 (9.4)	
SEER (Rated)			16.0		14.8	
EER (Rated)			11.0		9.5	
HSPF (Rated)			9.0		9.0	
Indoor unit			FTQ42TAVJUD, FTQ42TAVJUA		FTQ48TAVJUD, FTQ48TAVJUA	
Casing color			Daikin Slate Gray		Daikin Slate Gray	
Dimensions: (H×W×D)			53.43 × 21 × 21 (1,357 × 533 × 533)		53.43 × 21 × 21 (1,357 × 533 × 533)	
Coil	Type		Cross fin coil		Cross fin coil	
	Face area	ft ² (m ²)	5.15 (48)		5.15 (48)	
Fan	Type		Sirocco FC Centrifugal		Sirocco FC Centrifugal	
	Motor output	HP	3/4		3/4	
	Airflow rate (H/M/L)	cfm (m ³ /min)	1,400/1,190/980 (39.7/33.7/27.8)		1,520/1,290/1,060 (43.1/36.5/30.0)	
	External static pressure	in. w.g.	0.1" - 0.9"		0.1" - 0.9"	
Sound pressure level (H/M/L)			53.8/50.0/45.6		53.8/50.0/45.6	
Air filter			—★5		—★5	
Weight			150 (68)		150 (68)	
Connecting Pipes	Liquid Pipe	in (mm)	φ3/8 (φ9.5) (Brazing connection)		φ3/8 (φ9.5) (Brazing connection)	
	Gas Pipe	in (mm)	φ5/8 (φ15.9) (Brazing connection)		φ5/8 (φ15.9) (Brazing connection)	
	Drain Pipe	in (mm)	3/4" (19.1)		3/4" (19.1)	
Remote controller (option)	Wired		BRC1E73, BRC2A71		BRC1E73, BRC2A71	
	Wireless		BRC4C82		BRC4C82	
Outdoor unit			RZQ42TAVJUA		RZQ48TAVJUA	
Casing color			Ivory white		Ivory white	
Dimensions: (H×W×D)			52-15/16 × 35-7/16 × 12-5/8 (1,345 × 900 × 320)		52-15/16 × 35-7/16 × 12-5/8 (1,345 × 900 × 320)	
Coil	Type		Cross fin coil		Cross fin coil	
	Rows×Stages×FPI		2 × 60 × 19		2 × 60 × 19	
	Face area	ft ² (m ²)	12.2 (1.134)		12.2 (1.134)	
Compressor	Model		2YC90FXD#A		2YC90FXD#A	
	Type		Hermetically sealed swing type		Hermetically sealed swing type	
	Motor output	kW	3.5		3.5	
Fan	Model		P47N		P47N	
	Type		Propeller fan		Propeller fan	
	Motor output	W	70 × 2		70 × 2	
	Airflow rate	cfm (m ³ /min)	3,741 (106)		3,741 (106)	
Weight			225 (102)		225 (102)	
Sound pressure level (Cooling/Heating)			57 / 59		57 / 59	
Connecting Pipes	Liquid Pipe	in (mm)	φ3/8 (φ9.5) (Flare connection)		φ3/8 (φ9.5) (Flare connection)	
	Gas Pipe	in (mm)	φ5/8 (φ15.9) (Flare connection)		φ5/8 (φ15.9) (Flare connection)	
	Drain Pipe	in (mm)	φ1 (φ26) (Hole)		φ1 (φ26) (Hole)	
Safety devices			High pressure switch, Outdoor fan driver overload protector, Inverter overload protector, Fusible plugs, Fuse		High pressure switch, Outdoor fan driver overload protector, Inverter overload protector, Fusible plugs, Fuse	
Capacity Control			14-100		14-100	
Refrigerant control			Electronic expansion valve		Electronic expansion valve	
Ref. piping	Standard length	ft (m)	25 (7.6)		25 (7.6)	
	Max. length	ft (m)	230 (70)		230 (70)	
	Max. height difference	ft (m)	98 (30)		98 (30)	
Refrigerant	Model		R-410A		R-410A	
	Charge	lbs (kg)	7.9 (3.6)		7.9 (3.6)	
Ref. oil	Model		DAPHNE FVC50K		DAPHNE FVC50K	
	Charge	L	1.52		1.52	
Drawing No.	Sound (outdoor)		C: 4D101949D / C: 4D101950E		C: 4D101949D / C: 4D101950E	

Notes:
★1 Indoor temp.: 80°FDB (26.7°CDB), 67°FWB (19.4°CWB) / Outdoor temp.: 95°FDB (35.0°CDB) / Equivalent piping length: 25 ft (7.6 m), level difference: 0 ft (0 m).
★2 Indoor temp.: 70°FDB (21.1°CDB) / Outdoor temp.: 47°FDB (8.3°CDB), 43°FWB (6.1°CWB) / Equivalent piping length: 25 ft (7.6 m), level difference: 0 ft (0 m).
★3 Indoor temp.: 70°FDB (21.1°CDB) / Outdoor temp.: 17°FDB (-8.3°CDB), 15°FWB (-9.4°CWB) / Equivalent piping length: 25 ft (7.6 m), level difference: 0 ft (0 m).
★4 Capacities are net, including a deduction for cooling (an addition for heating) for indoor fan motor heat.
★5 Air filter is not standard accessory (field supply parts), but please mount it in the duct system of the suction side.

Model name		Indoor unit		FTQ18TAVJUD, FTQ18TAVJUA		FTQ24TAVJUD, FTQ24TAVJUA	
		Outdoor unit		RZQ18TBVJUA		RZQ24TBVJUA	
Power supply				1 phase, 208/230 V, 60 Hz		1 phase, 208/230 V, 60 Hz	
★1 ★4 Cooling capacity		Btu/h (kW)		17,200 (5.0)		23,400 (6.9)	
★2 ★4 Heating capacity		Btu/h (kW)		20,000 (5.9)		27,400 (8.0)	
★3 ★4 Heating capacity		Btu/h (kW)		13,600 (4.0)		19,400 (5.7)	
EER2 (Rated)		Btu/h-W		11.7		9.9	
SEER2 (Rated)				15.6		16.2	
HSPF2 (Rated)				8.1		8.7	
Indoor unit				FTQ18TAVJUD, FTQ18TAVJUA		FTQ24TAVJUD, FTQ24TAVJUA	
Casing color				Daikin Slate Gray		Daikin Slate Gray	
Dimensions: (H×W×D)		in (mm)		45 × 17.5 × 21 (1,143 × 445 × 533)		45 × 17.5 × 21 (1,143 × 445 × 533)	
Coil	Type			Cross fin coil		Cross fin coil	
Fan	Type			Sirocco FC Centrifugal		Sirocco FC Centrifugal	
	Motor output	HP		1/2		1/2	
	Airflow rate (H/M/L)	cfm (m ³ /min)		600/510/420 (17.0/14.4/11.9)		800/680/560 (22.7/19.3/15.9)	
	External static pressure	in. w.g.		0.1" - 0.9"		0.1" - 0.9"	
Air filter				—★5		—★5	
Weight		lbs (kg)		115 (52.2)		115 (52.2)	
Piping connections	Liquid	in (mm)		φ3/8 (φ9.5) (Braze connection)		φ3/8 (φ9.5) (Braze connection)	
	Gas	in (mm)		φ5/8 (φ15.9) (Braze connection)		φ5/8 (φ15.9) (Braze connection)	
	Drain	in (mm)		3/4" (19.1)		3/4" (19.1)	
Remote controller (accessory)	Wired			BRC1H71W, BRC1E73, BRC2A71		BRC1H71W, BRC1E73, BRC2A71	
	Wireless			BRC4C82		BRC4C82	
Outdoor unit				RZQ18TBVJUA		RZQ24TBVJUA	
Casing color				Ivory white		Ivory white	
Dimensions: (H×W×D)		in (mm)		39 × 37 × 12-5/8 (990 × 940 × 320)		39 × 37 × 12-5/8 (990 × 940 × 320)	
Coil	Type			Cross fin coil		Cross fin coil	
Compressor	Type			Hermetically sealed swing type		Hermetically sealed swing type	
	Motor output	kW		1.9		1.9	
Fan	Type			Propeller fan		Propeller fan	
	Motor output	W		200		200	
	Airflow rate	cfm (m ³ /min)		2,682 (76)		2,682 (76)	
Weight		lbs (kg)		172 (78)		172 (78)	
Piping connections	Liquid	in (mm)		φ3/8 (φ9.5) (Flare connection)		φ3/8 (φ9.5) (Flare connection)	
	Gas	in (mm)		φ5/8 (φ15.9) (Flare connection)		φ5/8 (φ15.9) (Flare connection)	
	Drain	in (mm)		φ1 (φ26) (Hole)		φ1 (φ26) (Hole)	
Safety devices				High pressure switch, Outdoor fan driver overload protector, Inverter overload protector, Fusible plugs, Fuse		High pressure switch, Outdoor fan driver overload protector, Inverter overload protector, Fusible plugs, Fuse	
Capacity step		%		14-100		14-100	
Refrigerant control				Electronic expansion valve		Electronic expansion valve	
Ref. piping	Standard length	ft (m)		25 (7.6)		25 (7.6)	
	Max. length	ft (m)		164 (50)		164 (50)	
	Max. height difference	ft (m)		98 (30)		98 (30)	
Refrigerant	Type			R-410A		R-410A	
	Charge	lbs (kg)		6.4 (2.9)		6.4 (2.9)	
Ref. oil	Type			DAPHNE FVC50K		DAPHNE FVC50K	
	Charge	L		1.08		1.08	

Notes:

★1 Indoor temp.: 80°FDB (26.7°CDB), 67°FWB (19.4°CWB) / Outdoor temp.: 95°FDB (35.0°CDB) / Equivalent piping length: 25 ft (7.6 m), height difference: 0 ft (0 m).

★2 Indoor temp.: 70°FDB (21.1°CDB) / Outdoor temp.: 47°FDB (8.3°CDB), 43°FWB (6.1°CWB) / Equivalent piping length: 25 ft (7.6 m), height difference: 0 ft (0 m).

★3 Indoor temp.: 70°FDB (21.1°CDB) / Outdoor temp.: 17°FDB (-8.3°CDB), 15°FWB (-9.4°CWB) / Equivalent piping length: 25 ft (7.6 m), height difference: 0 ft (0 m).

★4 Capacities are net, including a deduction for cooling (an addition for heating) for indoor fan motor heat.

★5 Air filter is not standard accessory (field supply parts), but please mount it in the duct system of the suction side.

Model name		Indoor unit		FTQ30TAVJUD, FTQ30TAVJUA		FTQ36TAVJUD, FTQ36TAVJUA	
		Outdoor unit		RZQ30TBVJUA		RZQ36TBVJUA	
Power supply				1 phase, 208/230 V, 60 Hz		1 phase, 208/230 V, 60 Hz	
★1 ★4 Cooling capacity		Btu/h (kW)		29,500 (8.6)		35,000 (10.3)	
★2 ★4 Heating capacity		Btu/h (kW)		34,000 (10.0)		40,000 (11.7)	
★3 ★4 Heating capacity		Btu/h (kW)		24,000 (7.0)		28,500 (8.4)	
EER2 (Rated)		Btu/h-W		11.9		11.2	
SEER2 (Rated)				15.6		16.4	
HSPF2 (Rated)				9.1		8.8	
Indoor unit				FTQ30TAVJUD, FTQ30TAVJUA		FTQ36TAVJUD, FTQ36TAVJUA	
Casing color				Daikin Slate Gray		Daikin Slate Gray	
Dimensions: (H×W×D)		in (mm)		45 × 17.5 × 21 (1,143 × 445 × 533)		45 × 17.5 × 21 (1,143 × 445 × 533)	
Coil	Type			Cross fin coil		Cross fin coil	
Fan	Type			Sirocco FC Centrifugal		Sirocco FC Centrifugal	
	Motor output	HP		1/2		1/2	
	Airflow rate (H/M/L)	cfm (m ³ /min)		1,000/850/700 (28.3/24.1/19.8)		1,050/900/750 (29.7/25.5/21.2)	
	External static pressure	in. w.g.		0.1" - 0.9"		0.1" - 0.9"	
Air filter				—★5		—★5	
Weight		lbs (kg)		115 (52.2)		140 (63.5)	
Piping connections	Liquid	in (mm)		φ3/8 (φ9.5) (Braze connection)		φ3/8 (φ9.5) (Braze connection)	
	Gas	in (mm)		φ5/8 (φ15.9) (Braze connection)		φ5/8 (φ15.9) (Braze connection)	
	Drain	in (mm)		3/4" (19.1)		3/4" (19.1)	
Remote controller (accessory)	Wired			BRC1H71W, BRC1E73, BRC2A71		BRC1H71W, BRC1E73, BRC2A71	
	Wireless			BRC4C82		BRC4C82	
Outdoor unit				RZQ30TBVJUA		RZQ36TBVJUA	
Casing color				Ivory white		Ivory white	
Dimensions: (H×W×D)		in (mm)		52-15/16 × 35-7/16 × 12-5/8 (1,345 × 900 × 320)		52-15/16 × 35-7/16 × 12-5/8 (1,345 × 900 × 320)	
Coil	Type			Cross fin coil		Cross fin coil	
Compressor	Type			Hermetically sealed swing type		Hermetically sealed swing type	
	Motor output	kW		3.5		3.5	
Fan	Type			Propeller fan		Propeller fan	
	Motor output	W		70 × 2		70 × 2	
	Airflow rate	cfm (m ³ /min)		3,741 (106)		3,741 (106)	
Weight		lbs (kg)		225 (102)		225 (102)	
Piping connections	Liquid	in (mm)		φ3/8 (φ9.5) (Flare connection)		φ3/8 (φ9.5) (Flare connection)	
	Gas	in (mm)		φ5/8 (φ15.9) (Flare connection)		φ5/8 (φ15.9) (Flare connection)	
	Drain	in (mm)		φ1 (φ26) (Hole)		φ1 (φ26) (Hole)	
Safety devices				High pressure switch, Outdoor fan driver overload protector, Inverter overload protector, Fusible plugs, Fuse		High pressure switch, Outdoor fan driver overload protector, Inverter overload protector, Fusible plugs, Fuse	
Capacity step		%		14-100		14-100	
Refrigerant control				Electronic expansion valve		Electronic expansion valve	
Ref. piping	Standard length	ft (m)		25 (7.6)		25 (7.6)	
	Max. length	ft (m)		230 (70)		230 (70)	
	Max. height difference	ft (m)		98 (30)		98 (30)	
Refrigerant	Type			R-410A		R-410A	
	Charge	lbs (kg)		7.9 (3.6)		7.9 (3.6)	
Ref. oil	Type			DAPHNE FVC50K		DAPHNE FVC50K	
	Charge	L		1.52		1.52	

Notes:

- ★1 Indoor temp.: 80°FDB (26.7°CDB), 67°FWB (19.4°CWB) / Outdoor temp.: 95°FDB (35.0°CDB) / Equivalent piping length: 25 ft (7.6 m), height difference: 0 ft (0 m).
- ★2 Indoor temp.: 70°FDB (21.1°CDB) / Outdoor temp.: 47°FDB (8.3°CDB), 43°FWB (6.1°CWB) / Equivalent piping length: 25 ft (7.6 m), height difference: 0 ft (0 m).
- ★3 Indoor temp.: 70°FDB (21.1°CDB) / Outdoor temp.: 17°FDB (-8.3°CDB), 15°FWB (-9.4°CWB) / Equivalent piping length: 25 ft (7.6 m), height difference: 0 ft (0 m).
- ★4 Capacities are net, including a deduction for cooling (an addition for heating) for indoor fan motor heat.
- ★5 Air filter is not standard accessory (field supply parts), but please mount it in the duct system of the suction side.

Model name		Indoor unit		FTQ42TAVJUD, FTQ42TAVJUA		FTQ48TAVJUD, FTQ48TAVJUA	
		Outdoor unit		RZQ42TBVJUA		RZQ48TBVJUA	
Power supply				1 phase, 208/230 V, 60 Hz		1 phase, 208/230 V, 60 Hz	
★1 ★4 Cooling capacity		Btu/h (kW)		40,500 (11.9)		47,000 (13.8)	
★2 ★4 Heating capacity		Btu/h (kW)		47,000 (13.8)		54,000 (15.8)	
★3 ★4 Heating capacity		Btu/h (kW)		33,000 (9.7)		36,800 (10.8)	
EER2 (Rated)		Btu/h-W		10.6		9.1	
SEER2 (Rated)				16.0		15.3	
HSPF2 (Rated)				9.2		8.8	
Indoor unit				FTQ42TAVJUD, FTQ42TAVJUA		FTQ48TAVJUD, FTQ48TAVJUA	
Casing color				Daikin Slate Gray		Daikin Slate Gray	
Dimensions: (H×W×D)		in (mm)		53.43 × 21 × 21 (1,357 × 533 × 533)		53.43 × 21 × 21 (1,357 × 533 × 533)	
Coil		Type		Cross fin coil		Cross fin coil	
Fan		Type		Sirocco FC Centrifugal		Sirocco FC Centrifugal	
		Motor output	HP	3/4		3/4	
		Airflow rate (H/M/L)	cfm (m ³ /min)	1,400/1,190/980 (39.7/33.7/27.8)		1,520/1,290/1,060 (43.1/36.5/30.0)	
		External static pressure	in. w.g.	0.1" - 0.9"		0.1" - 0.9"	
Air filter				—★5		—★5	
Weight		lbs (kg)		150 (68)		150 (68)	
Piping connections		Liquid	in (mm)	φ3/8 (φ9.5) (Braze connection)		φ3/8 (φ9.5) (Braze connection)	
		Gas	in (mm)	φ5/8 (φ15.9) (Braze connection)		φ5/8 (φ15.9) (Braze connection)	
		Drain	in (mm)	3/4" (19.1)		3/4" (19.1)	
Remote controller (accessory)		Wired		BRC1H71W, BRC1E73, BRC2A71		BRC1H71W, BRC1E73, BRC2A71	
		Wireless		BRC4C82		BRC4C82	
Outdoor unit				RZQ42TBVJUA		RZQ48TBVJUA	
Casing color				Ivory white		Ivory white	
Dimensions: (H×W×D)		in (mm)		52-15/16 × 35-7/16 × 12-5/8 (1,345 × 900 × 320)		52-15/16 × 35-7/16 × 12-5/8 (1,345 × 900 × 320)	
Coil		Type		Cross fin coil		Cross fin coil	
Compressor		Type		Hermetically sealed swing type		Hermetically sealed swing type	
		Motor output	kW	3.5		3.5	
Fan		Type		Propeller fan		Propeller fan	
		Motor output	W	70 × 2		70 × 2	
		Airflow rate	cfm (m ³ /min)	3,741 (106)		3,741 (106)	
Weight		lbs (kg)		225 (102)		225 (102)	
Piping connections		Liquid	in (mm)	φ3/8 (φ9.5) (Flare connection)		φ3/8 (φ9.5) (Flare connection)	
		Gas	in (mm)	φ5/8 (φ15.9) (Flare connection)		φ5/8 (φ15.9) (Flare connection)	
		Drain	in (mm)	φ1 (φ26) (Hole)		φ1 (φ26) (Hole)	
Safety devices				High pressure switch, Outdoor fan driver overload protector, Inverter overload protector, Fusible plugs, Fuse		High pressure switch, Outdoor fan driver overload protector, Inverter overload protector, Fusible plugs, Fuse	
Capacity step		%		14-100		14-100	
Refrigerant control				Electronic expansion valve		Electronic expansion valve	
Ref. piping		Standard length	ft (m)	25 (7.6)		25 (7.6)	
		Max. length	ft (m)	230 (70)		230 (70)	
		Max. height difference	ft (m)	98 (30)		98 (30)	
Refrigerant		Type		R-410A		R-410A	
		Charge	lbs (kg)	7.9 (3.6)		7.9 (3.6)	
Ref. oil		Type		DAPHNE FVC50K		DAPHNE FVC50K	
		Charge	L	1.52		1.52	
Notes:							
★1 Indoor temp.: 80°FDB (26.7°CDB), 67°FWB (19.4°CWB) / Outdoor temp.: 95°FDB (35.0°CDB) / Equivalent piping length: 25 ft (7.6 m), height difference: 0 ft (0 m).							
★2 Indoor temp.: 70°FDB (21.1°CDB) / Outdoor temp.: 47°FDB (8.3°CDB), 43°FWB (6.1°CWB) / Equivalent piping length: 25 ft (7.6 m), height difference: 0 ft (0 m).							
★3 Indoor temp.: 70°FDB (21.1°CDB) / Outdoor temp.: 17°FDB (-8.3°CDB), 15°FWB (-9.4°CWB) / Equivalent piping length: 25 ft (7.6 m), height difference: 0 ft (0 m).							
★4 Capacities are net, including a deduction for cooling (an addition for heating) for indoor fan motor heat.							
★5 Air filter is not standard accessory (field supply parts), but please mount it in the duct system of the suction side.							

Part 2

Refrigerant Circuit

1. Refrigerant Circuit (Piping Diagrams)	91
1.1 Outdoor Unit	91
1.2 Indoor Unit.....	97
2. Functional Parts Layout	99
2.1 RZR18/24TAVJU, RZQ18/24TAVJU.....	99
2.2 RZR18/24TAVJUA, RZQ18/24TAVJUA, RZR18/24TBVJUA, RZQ18/24TBVJUA	101
2.3 RZR30-48TAVJU, RZQ30-48TAVJU	103
2.4 RZR30-48TAVJUA, RZQ30-48TAVJUA, RZR30-48TBVJUA, RZQ30-48TBVJUA.....	105

1. Refrigerant Circuit (Piping Diagrams)

1.1 Outdoor Unit

1.1.1 18/24 Class

No. in piping diagram	Electric symbol	Name	Function
(1)	M1C	Compressor	Compressor is operated in multi-steps according to Te and Tc.
(2)	M1F	Fan motor	The fan rotation speed is varied by using inverter.
(3)	Y1E	Electronic expansion valve (Main)	While in heating operation, PI control is applied to keep the outlet superheated degree of air heat exchanger constant.
(4)	Y1S	Four way valve	Used to switch the operation mode between cooling and heating.
(5)	Y2S	Solenoid valve (Hot gas)	Used to prevent the low pressure from transient falling.
(6)	Y3S	Solenoid valve (Unload circuit)	Used for unloading operation of compressor.
(7)	S1NPH	High pressure sensor	Used to detect high pressure.
(8)	S1NPL	Low pressure sensor	Used to detect low pressure.
(9)	S1PH	High pressure switch (For compressor)	In order to prevent the increase of high pressure when an error occurs, this switch is activated at high pressure of 4.0 MPa (580 psi) or more to stop the compressor operation.
(10)	—	Fusible plug	In order to prevent the increase of pressure when abnormal heating is caused by fire or others, the fusible part of the plug is molten at a temperature of 70 to 75°C (158 to 167°F) to release the pressure into the atmosphere.
(11)	—	Pressure regulating valve (Receiver to discharge pipe)	This valve opens at a pressure of 4.0 MPa (580 psi) for prevention of pressure increase, thus resulting in no damage of functional parts due to the increase of pressure in transportation or storage.
(12)	R1T	Thermistor (Outdoor air: Ta)	Used to detect outdoor air temperature, correct discharge pipe temperature, and for other purposes.
(13)	R2T	Thermistor (Discharge pipe: Tdi)	Used to detect discharge pipe temperature, make the temperature protection control of compressor, and for other purposes.
(14)	R3T	Thermistor (Suction pipe 1: Ts1)	Used to detect suction pipe temperature, keep the suction superheated degree constant in heating operation, and for other purposes.
(15)	R4T	Thermistor (Heat exchanger deicer: Tb)	Used to detect liquid pipe temperature of air heat exchanger, determine defrosting operation, and for other purposes.
(16)	R5T	Thermistor (Suction pipe 2: Ts2)	Used to the calculation of an internal temperature of compressor etc.
(17)	R7T	Thermistor (Liquid pipe: Tl)	Used to detect refrigerant overcharge in check operation, and for other purposes.
(18)	R10T	Thermistor (Radiation fin)	Used for outdoor fan speed control, inverter radiation fin temperature control, pressure difference control.

RZR18/24TAVJU, RZQ18/24TAVJU

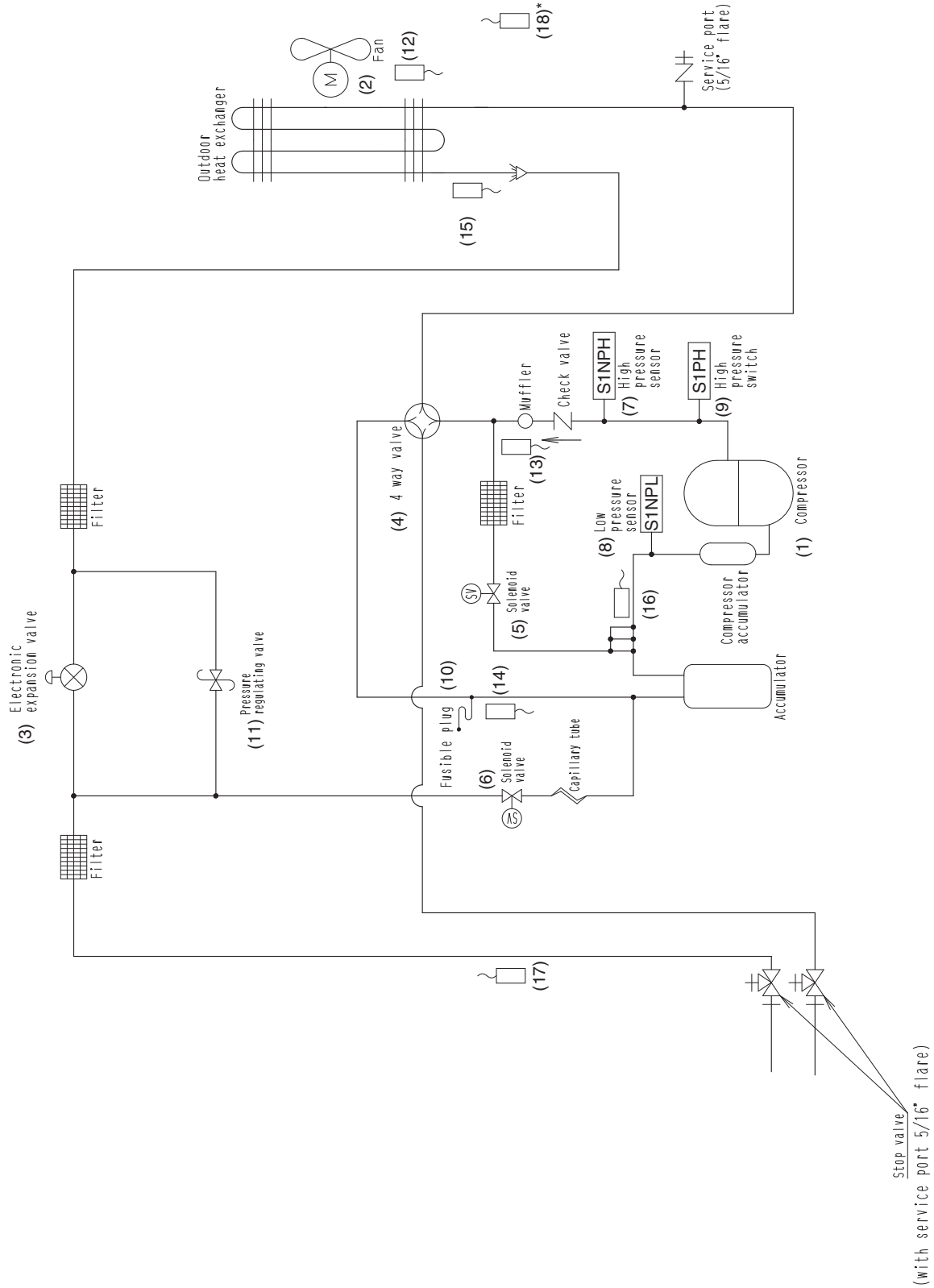

* The radiation fin thermistor (18) is located near the electrical component box.

C: 3D082498F

RZR18/24TAVJUA, RZQ18/24TAVJUA, RZR18/24TBVJUA, RZQ18/24TBVJUA

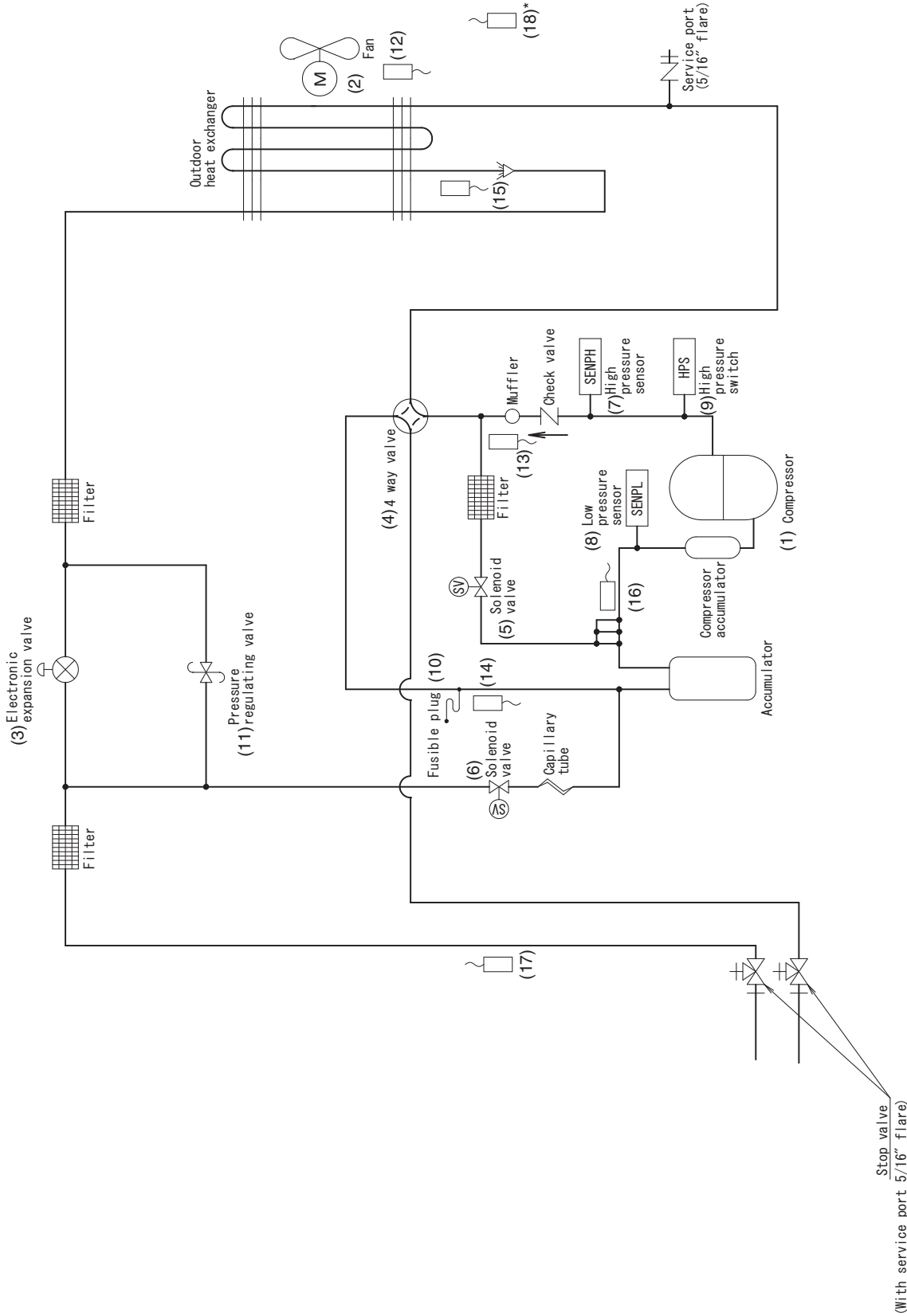

* The radiation fin thermistor (18) is located near the electrical component box.

C: 3D132130

1.1.2 30-48 Class

No. in piping diagram	Electric symbol	Name	Function
(1)	M1C	Compressor	Compressor is operated in multi-steps according to Te and Tc.
(2)	M1F M2F	Fan motor	The fan rotation speed is varied by using inverter.
(3)	Y1E	Electronic expansion valve (Main)	While in heating operation, PI control is applied to keep the outlet superheated degree of air heat exchanger constant.
(4)	Y3E	Electronic expansion valve (Subcooling)	PI control is applied to keep the outlet superheated degree of subcooling heat exchanger constant.
(5)	Y1S	Four way valve	Used to switch the operation mode between cooling and heating.
(6)	S1NPH	High pressure sensor	Used to detect high pressure.
(7)	S1NPL	Low pressure sensor	Used to detect low pressure.
(8)	S1PH	High pressure switch (For compressor)	In order to prevent the increase of high pressure when an error occurs, this switch is activated at high pressure of 4.0 MPa (580 psi) or more to stop the compressor operation.
(9)	—	Fusible plug	In order to prevent the increase of pressure when abnormal heating is caused by fire or others, the fusible part of the plug is molten at a temperature of 70 to 75°C (158 to 167°F) to release the pressure into the atmosphere.
(10)	—	Pressure regulating valve (Receiver to discharge pipe)	This valve opens at a pressure of 4.0 MPa (580 psi) for prevention of pressure increase, thus resulting in no damage of functional parts due to the increase of pressure in transportation or storage.
(11)	R1T	Thermistor (Outdoor air: Ta)	Used to detect outdoor air temperature, correct discharge pipe temperature, and for other purposes.
(12)	R2T	Thermistor (Discharge pipe: Tdi)	Used to detect discharge pipe temperature, make the temperature protection control of compressor, and for other purposes.
(13)	R3T	Thermistor (Suction pipe1: Ts1)	Used to detect suction pipe temperature, keep the suction superheated degree constant in heating operation, and for other purposes.
(14)	R4T	Thermistor (Heat exchanger deicer: Tb)	Used to detect liquid pipe temperature of air heat exchanger, determine defrosting operation, and for other purposes.
(15)	R5T	Thermistor (Suction pipe2: Ts2)	Used to the calculation of an internal temperature of compressor etc.
(16)	R6T	Thermistor (Subcooling heat exchanger gas pipe: Tsh)	Used to control subcooling electronic expansion valve.
(17)	R7T	Thermistor (Liquid pipe: Tl)	Used to detect refrigerant overcharge in check operation, and for other purposes.
(18)	FINTH	Thermistor (Radiation fin)	Used for outdoor fan speed control, inverter radiation fin temperature control, pressure difference control.

RZR30/36/42/48TAVJU, RZQ30/36/42/48TAVJU

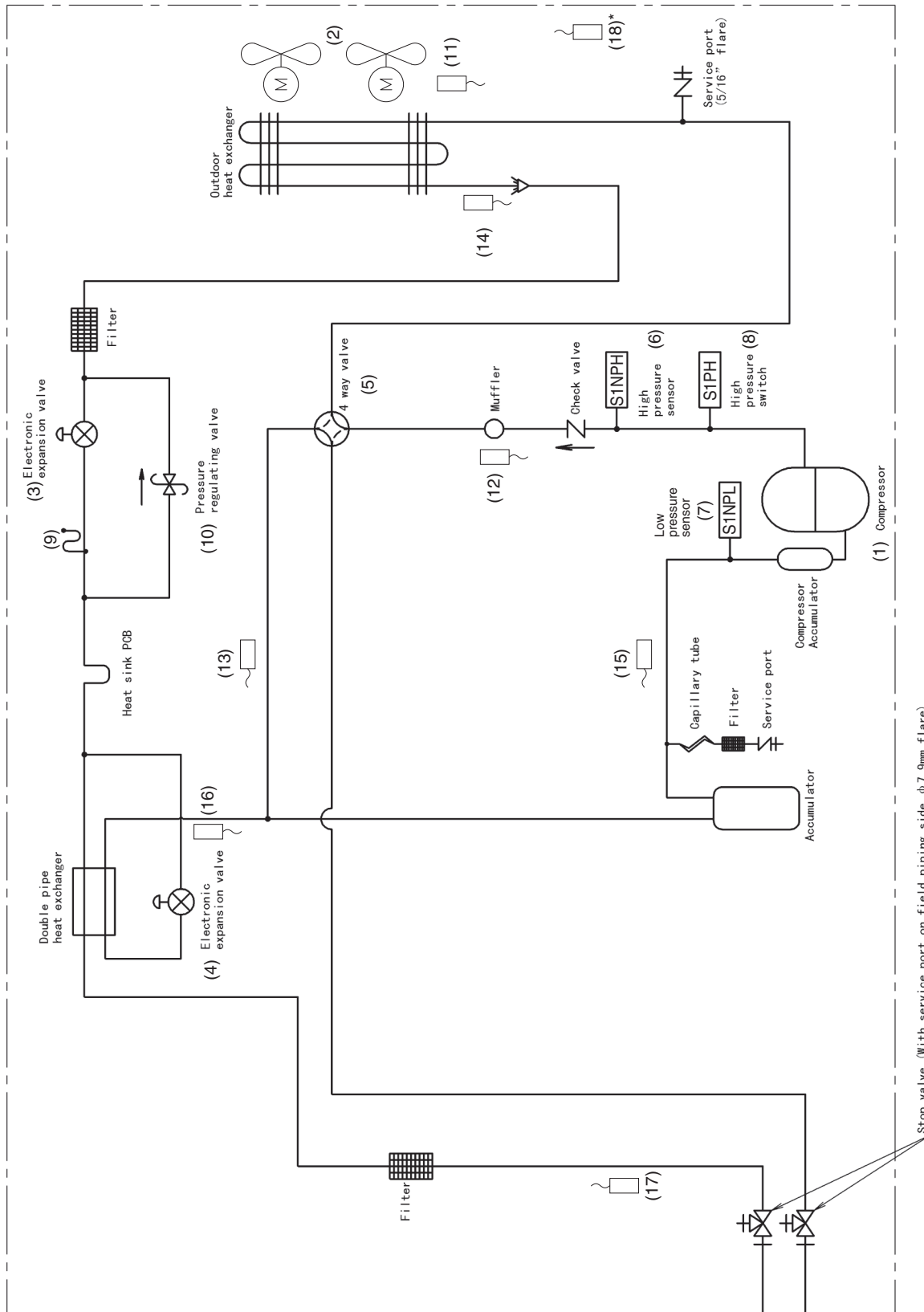

* The radiation fin thermistor (18) is located near the electrical component box.

C: 3D088595A

RZR30/36/42/48TAVJUA, RZQ30/36/42/48TAVJUA, RZR30/36/42/48TBVJUA, RZQ30/36/42/48TBVJUA

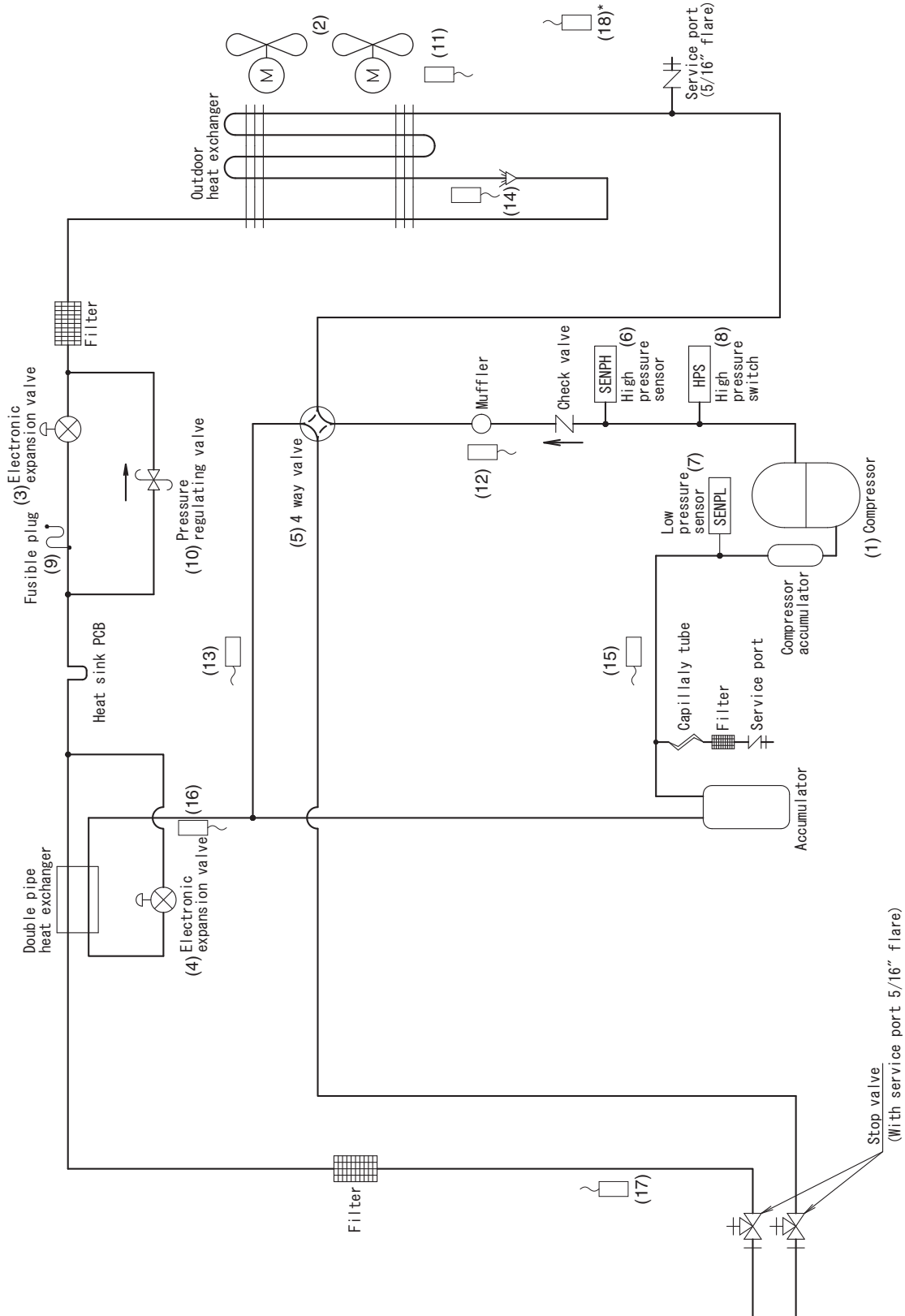

* The radiation fin thermistor (18) is located near the electrical component box.

C: 3D132132

1.2 Indoor Unit

No. in piping diagram	Name	Symbol			Function
		Except FBQ-P FTQ-TA	FBQ-P	FTQ-TA	
(1)	Electronic expansion valve	Y1E	Y1E	Y1E	Used for gas superheating degree control while in cooling or subcooling degree control while in heating.
(2)	Suction air thermistor	R1T	R1T	R1T (*1)	Used for thermostat control.
(3)	Liquid pipe thermistor	R2T	R2T	R2T	Used for gas superheating degree control while in cooling or subcooling degree control while in heating.
(4)	Gas pipe thermistor	R3T	R3T	R3T	Used for gas superheating degree control while in cooling.
(5)	Discharge air thermistor	—	R4T	—	Used for discharge air temperature control.

*1. R1T is for remote controller thermistor or optional remote sensor.

■ FCQ-TA, FAQ-TA

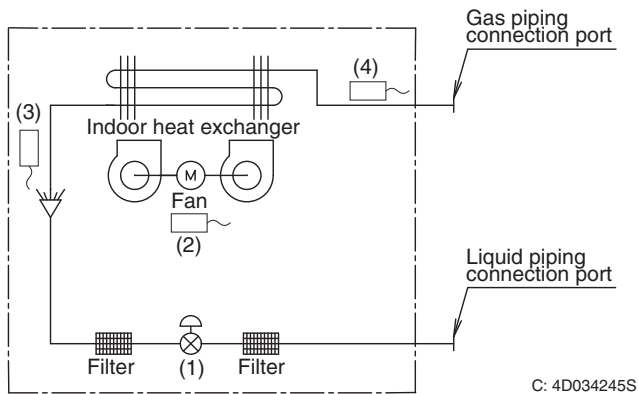

■ FCQ-AA

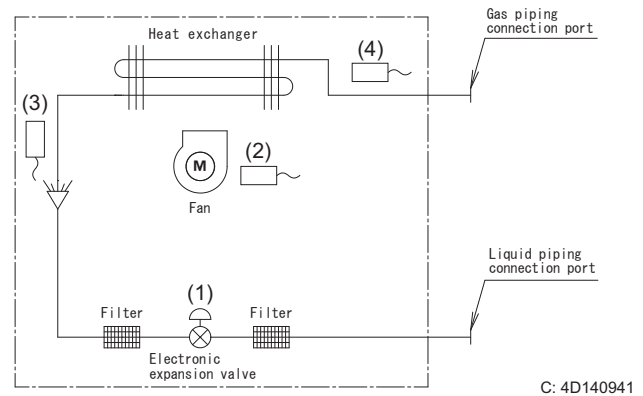

■ FHQ-P, FHQ-M

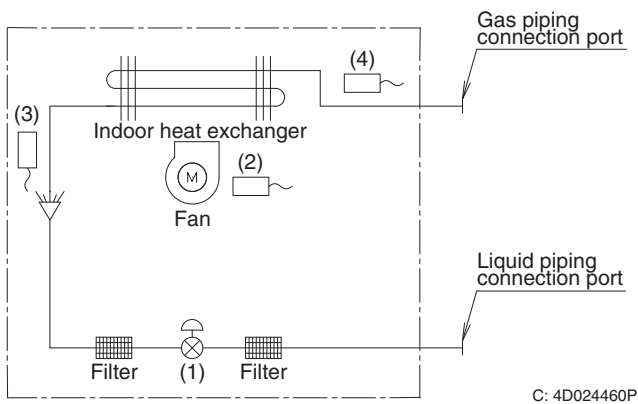

■ FBQ-P

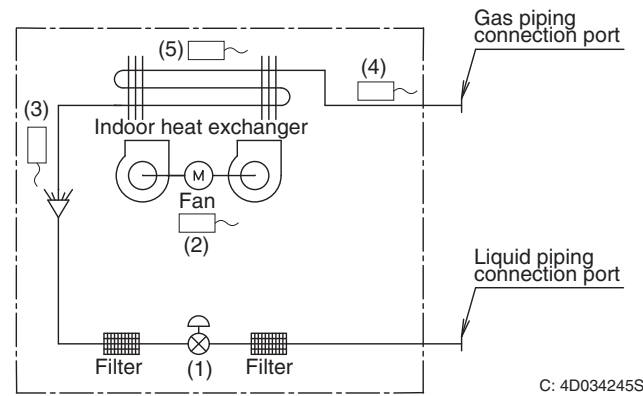

■ FBQ-TB

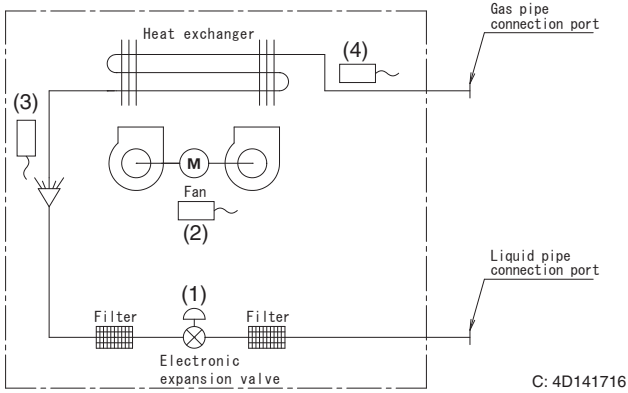

■ FTQ-TA

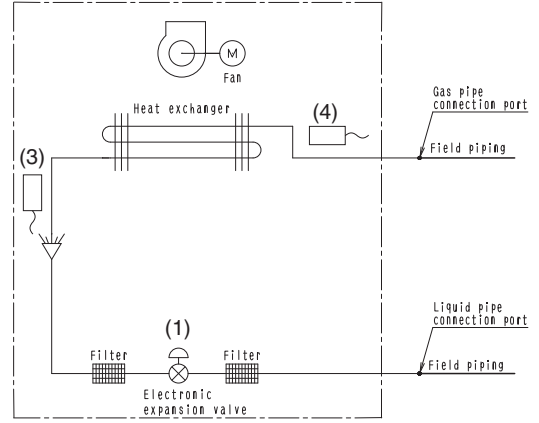

2. Functional Parts Layout

2.1 RZR18/24TAVJU, RZQ18/24TAVJU

Top view

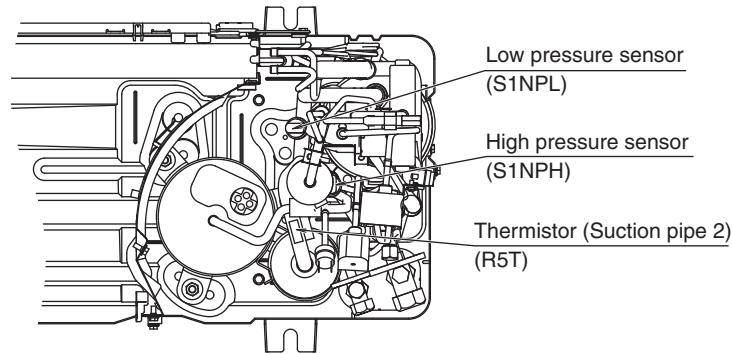

Front view

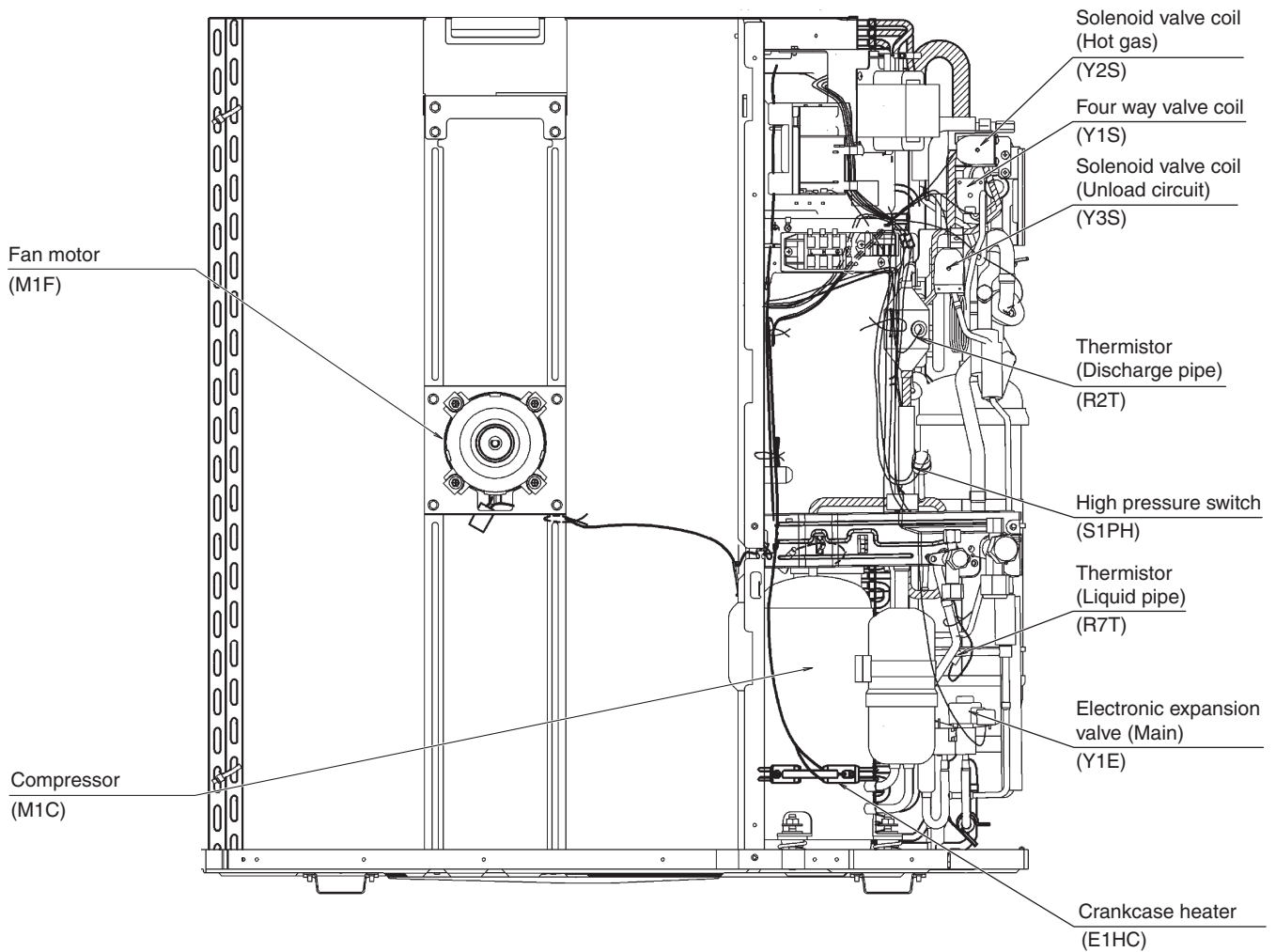

C: 1P342997N

Side view

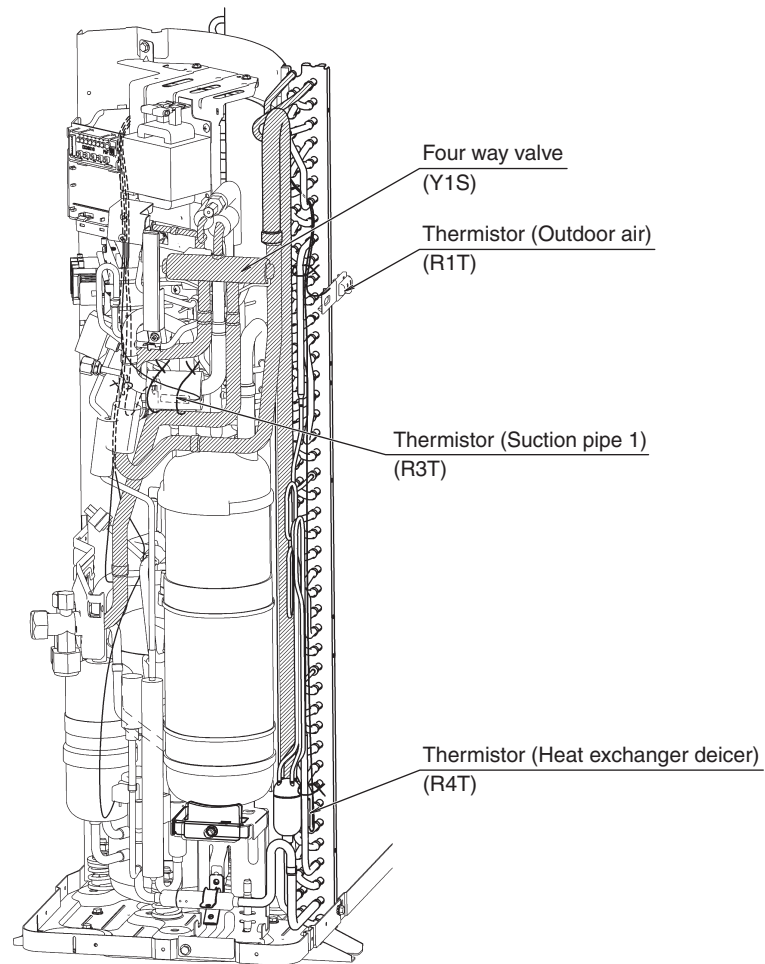

C: 1P342997N

2.2 RZR18/24TAVJUA, RZQ18/24TAVJUA, RZR18/24TBVJUA, RZQ18/24TBVJUA

Top view

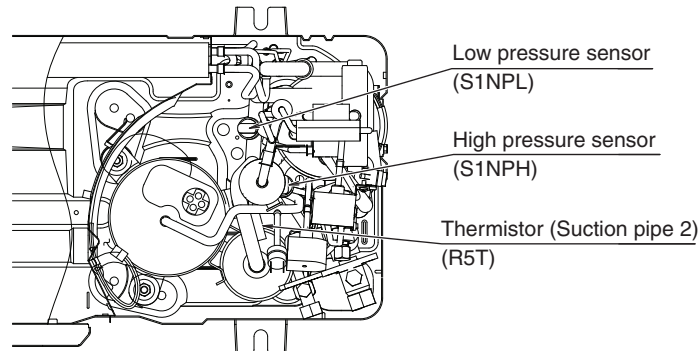

Front view

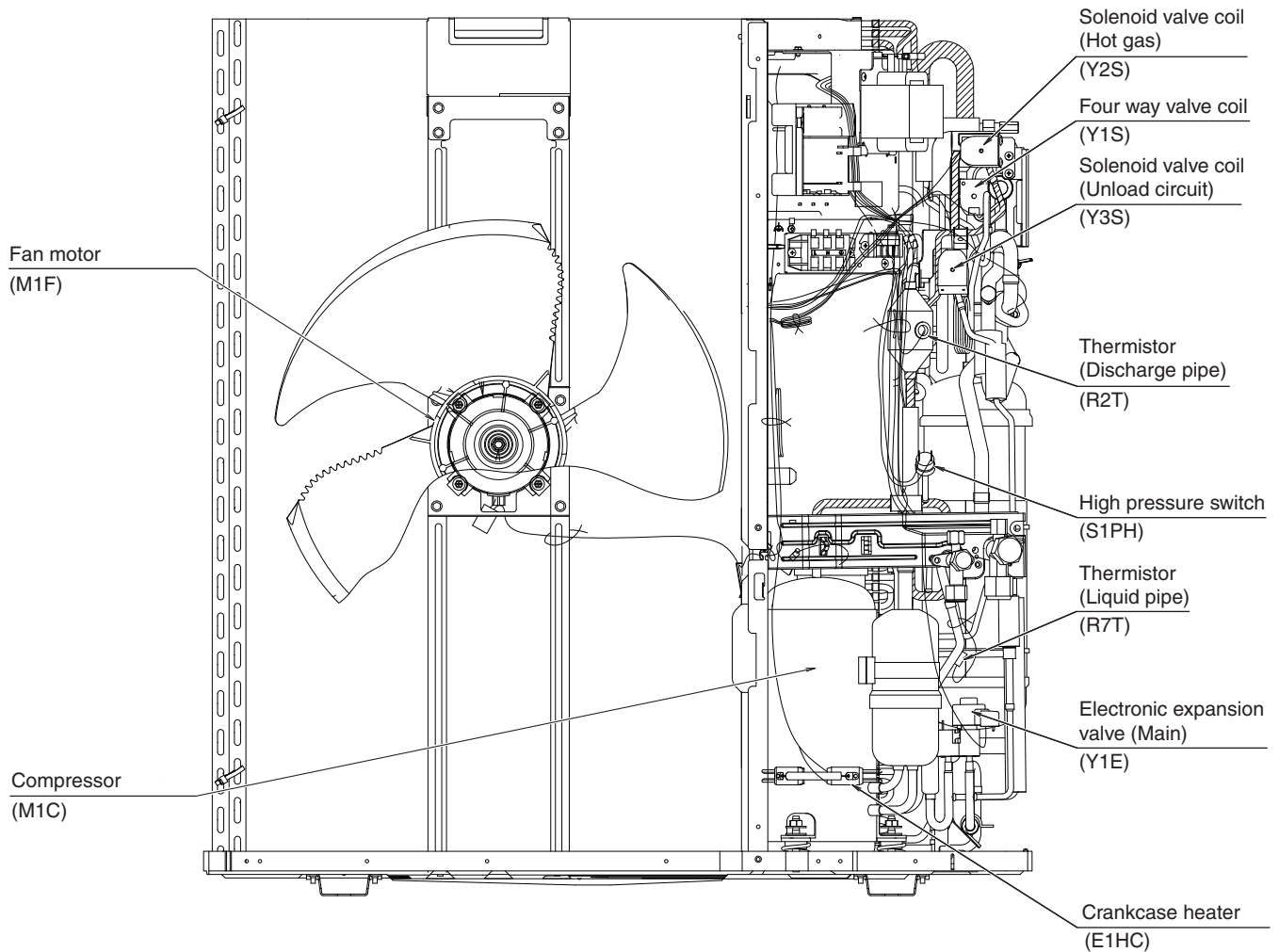

C: 1P589934F

Side view

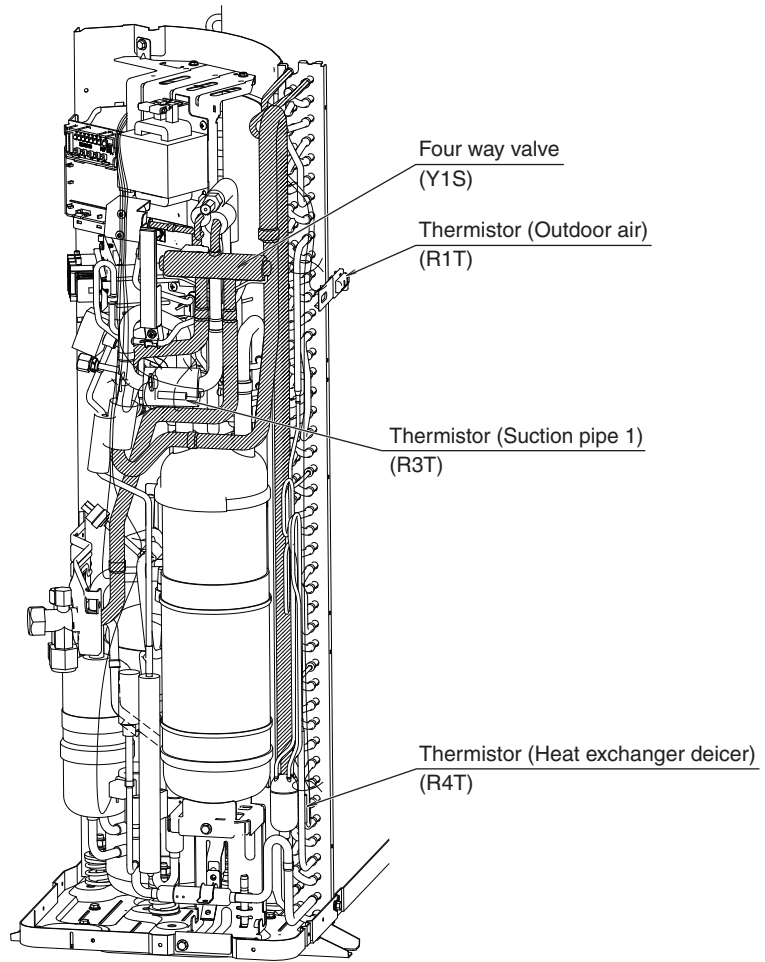

C: 1P589934F

2.3 RZR30-48TAVJU, RZQ30-48TAVJU

Front view

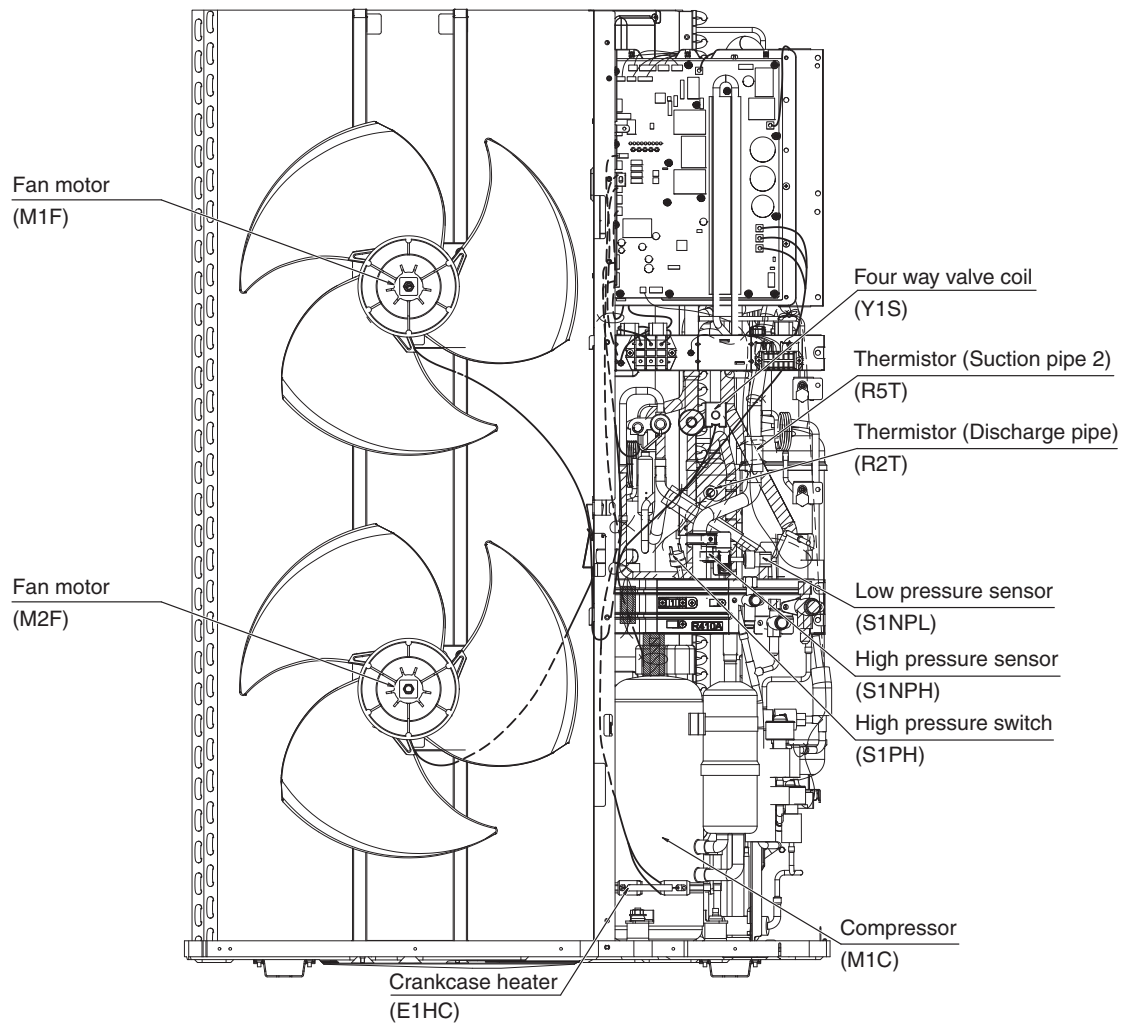

C: 1P441643P

Side view

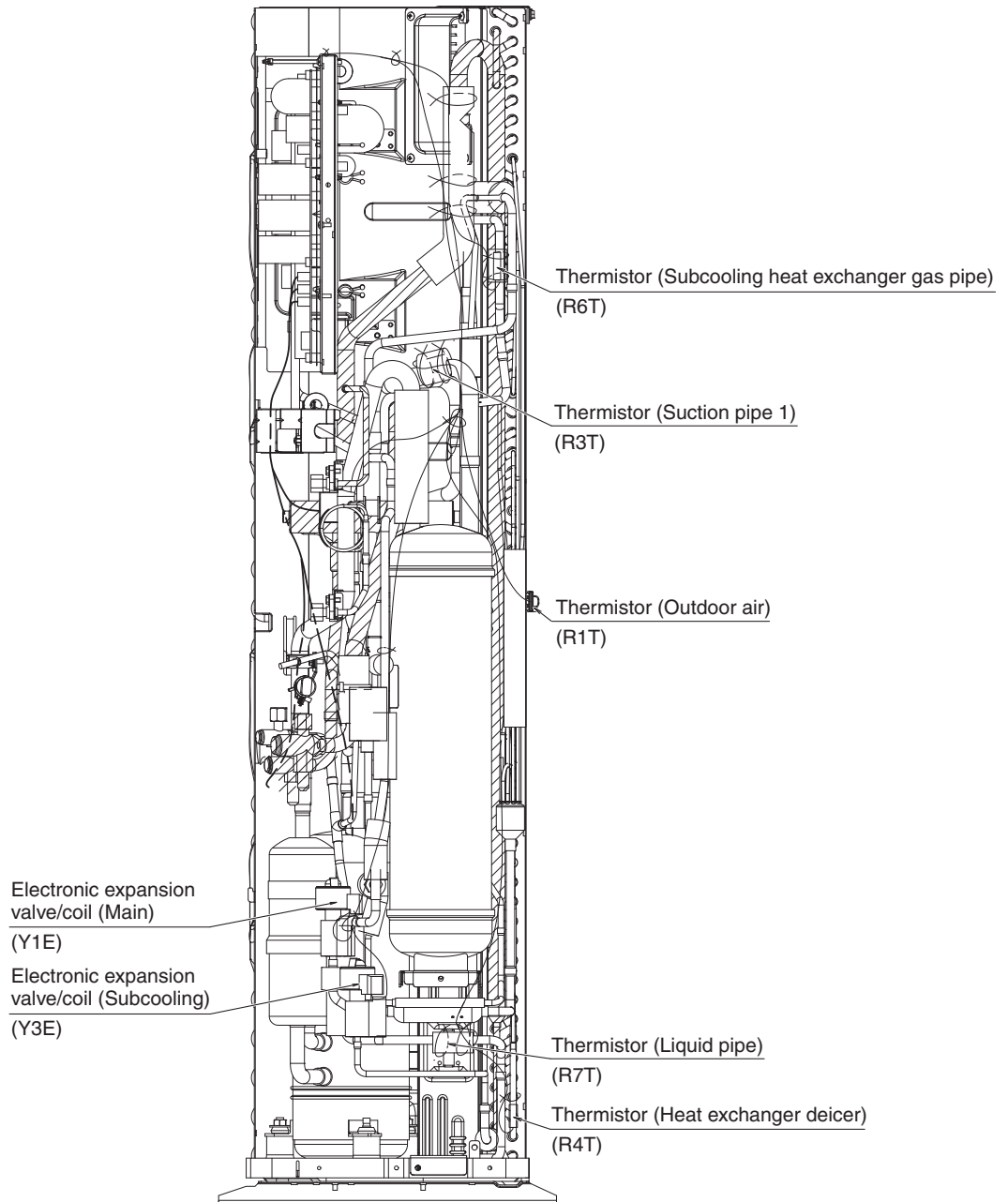

C: 1P441643P

2.4 RZR30-48TAVJUA, RZQ30-48TAVJUA, RZR30-48TBVJUA, RZQ30-48TBVJUA

Front view

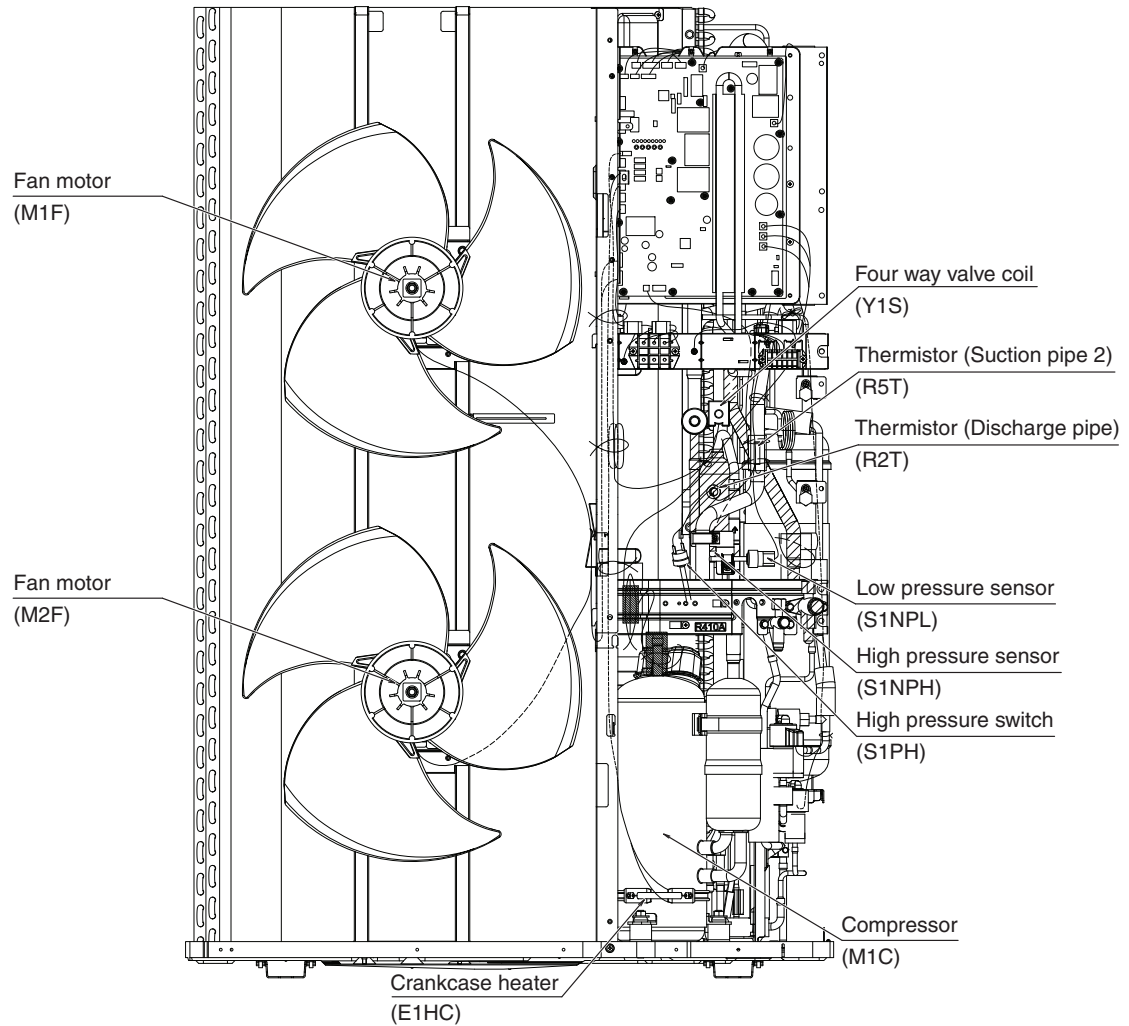

C: 1P589937E

Side view

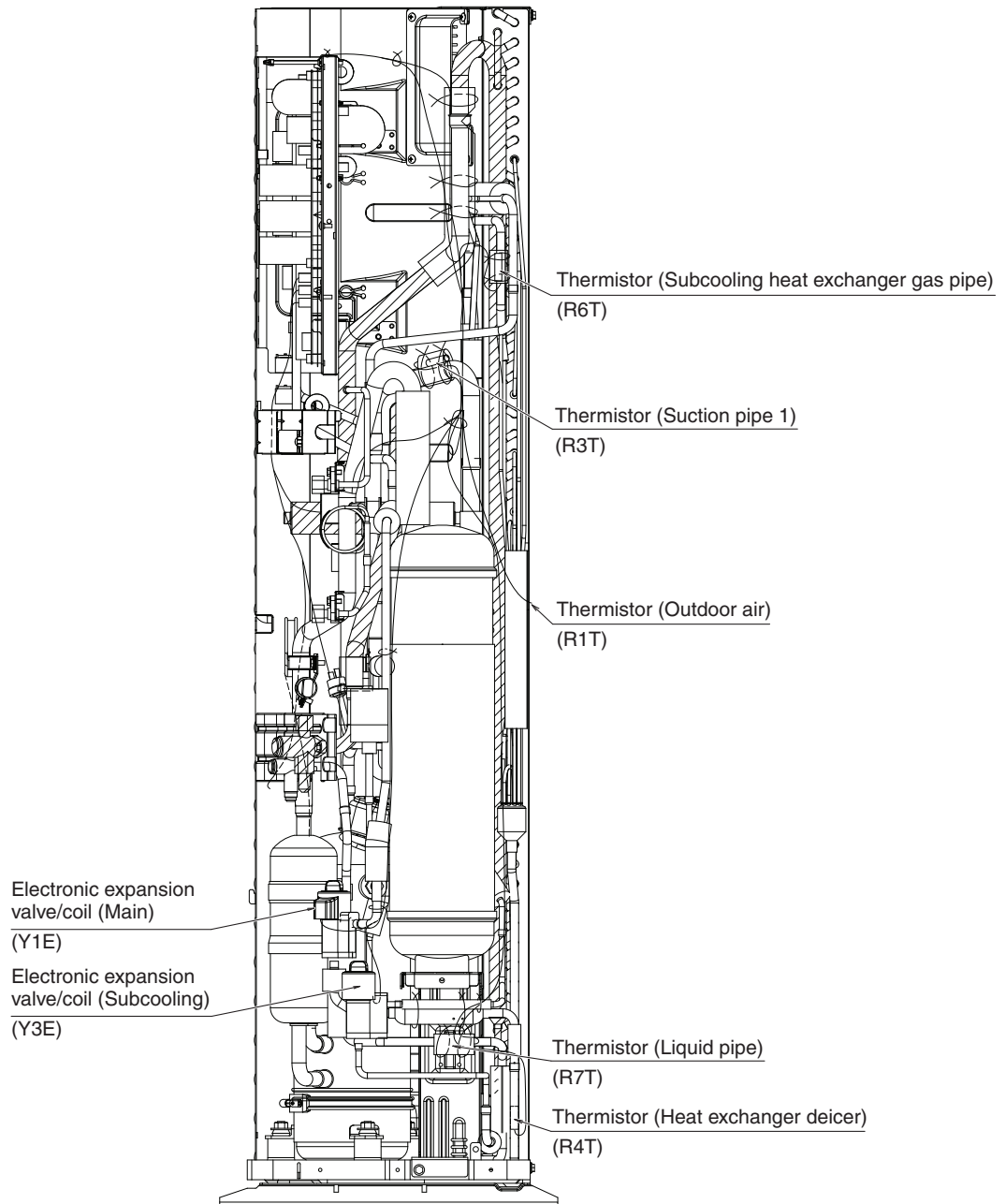

C: 1P589937E

Part 3

Remote Controller

1. Applicable Models	108
2. Names and Functions	109
2.1 BRC1E73	109
2.2 BRC1H71W	112
2.3 Simplified Remote Controller	120
2.4 Wireless Remote Controller	121
3. Main/Sub Setting	123
3.1 Wired Remote Controller (BRC1E73)	123
3.2 Wired Remote Controller (BRC1H71W)	124
3.3 When Wireless Remote Controller is Used Together	126
4. Address Setting for Wireless Remote Controller	127
5. Centralized Control Group No. Setting	130
5.1 BRC1E73	130
5.2 BRC1H71W	132
5.3 Wireless Remote Controller	133
6. Service Settings Menu, Maintenance Menu	134
6.1 BRC1E73	134
6.2 Wireless Remote Controller	138
7. Administrator Menu, Installer Menu	139
7.1 BRC1H71W	139

1. Applicable Models

Indoor unit		Wired remote controller		Simplified remote controller	Wireless remote controller
		Navigation	Madoka		
Ceiling mounted cassette type (round flow with sensing panel)	FCQ-TA	BRC1E73	BRC1H71W	BRC2A71	—
	FCQ-AA				—
Ceiling suspended type	FHQ-P				BRC7E83
	FHQ-M				BRC7E818
Wall mounted type	FAQ-TA				BRC4C82 (Fan: 2 steps) BRC082A43 (Fan: 3 steps)
HSP ceiling mounted duct type	FBQ-P				BRC082A43
	FBQ-TB				BRC4C82
Multi position air handling unit	FTQ-TA				

2. Names and Functions

2.1 BRC1E73

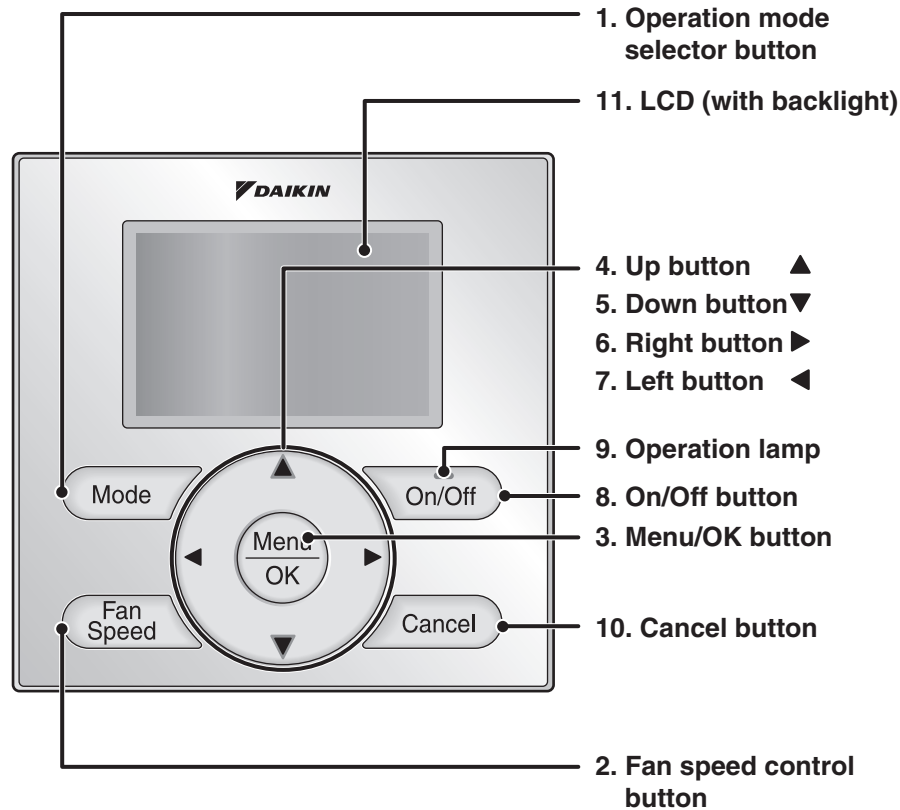

Functions other than basic operation items (i.e., On/Off, Operation Mode, Fan Speed, and Setpoint) are set from the menu screen.



Note:

- Do not install the remote controller in places exposed to direct sunlight, the LCD will be damaged.
- Do not pull or twist the remote controller cord, the remote controller may be damaged.
- Do not use objects with sharp ends to press the buttons on the remote controller damage may result.

1. Operation mode selector button

- Press this button to select the operation mode of your preference.
* Available modes vary with the indoor unit model.

2. Fan speed control button

- Press this button to select the fan speed of your preference.
* Available fan speeds vary with the indoor unit model.

3. Menu/OK button

- Used to enter the main menu.
- Used to enter the selected item.

4. Up button ▲

- Used to raise the setpoint.
- The item above the current selection will be highlighted.
(The highlighted items will be scrolled continuously when the button is continuously pressed.)
- Used to change the selected item.

5. Down button ▼

- Used to lower the setpoint.
- The item below the current selection will be highlighted.
(The highlighted items will be scrolled continuously when the button is continuously pressed.)
- Used to change the selected item.

6. Right button ►

- Used to highlight the next items on the right-hand side.
- Each screen is scrolled in the right-hand direction.

7. Left button ◀

- Used to highlight the next items on the left-hand side.
- Each screen is scrolled in the left-hand direction.

8. On/Off button

- Press this button and system will start.
- Press this button again to stop the system.

9. Operation lamp

- This lamp illuminates solid green during normal operation.
- This lamp blinks if an error occurs.

10. Cancel button

- Used to return to the previous screen.

11. LCD (with backlight)

- The backlight will be illuminated for approximately 30 seconds by pressing any button.
- If two remote controllers are used to control a single indoor unit, only the controller accessed first will have backlight functionality.



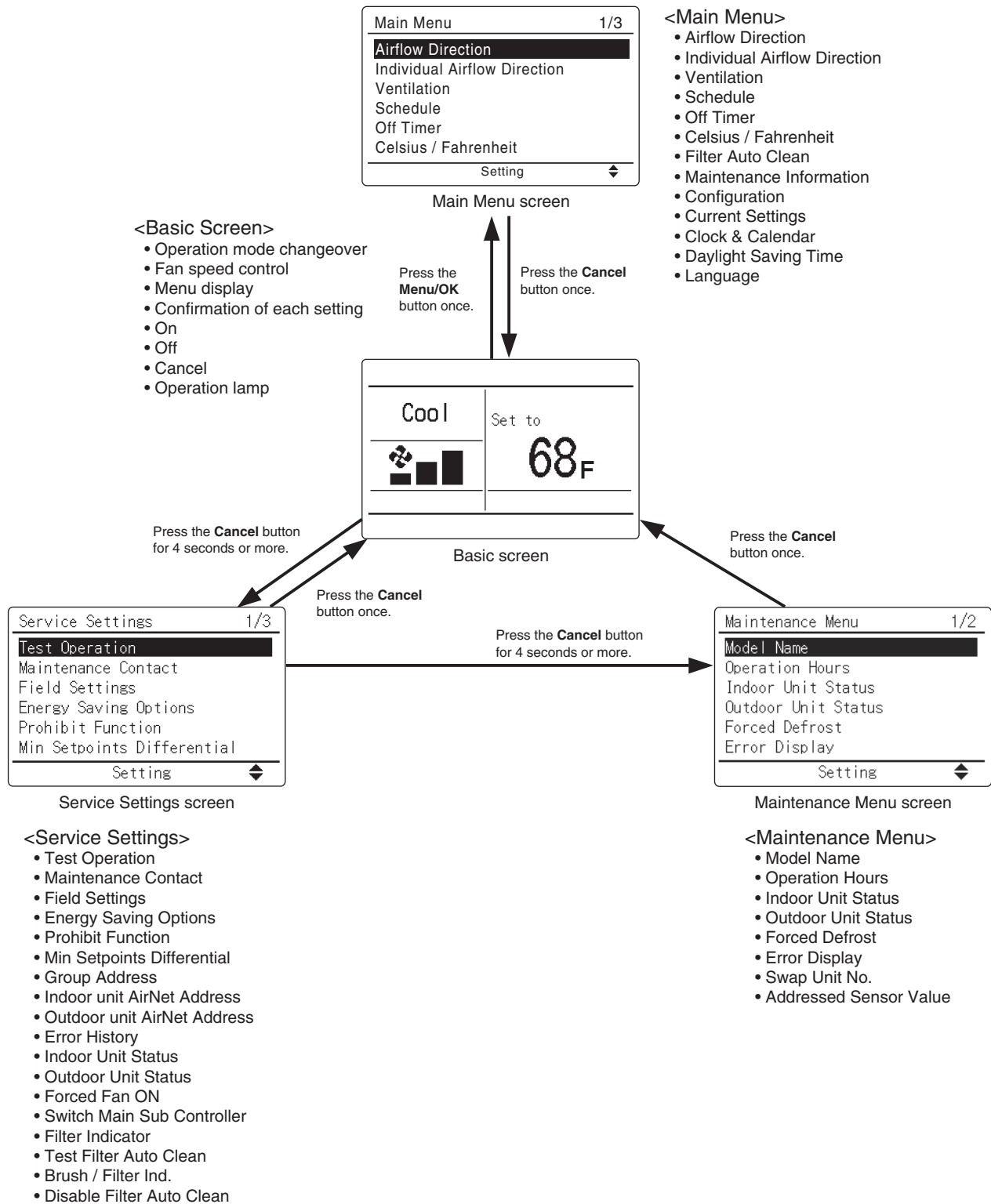

Service Check Function

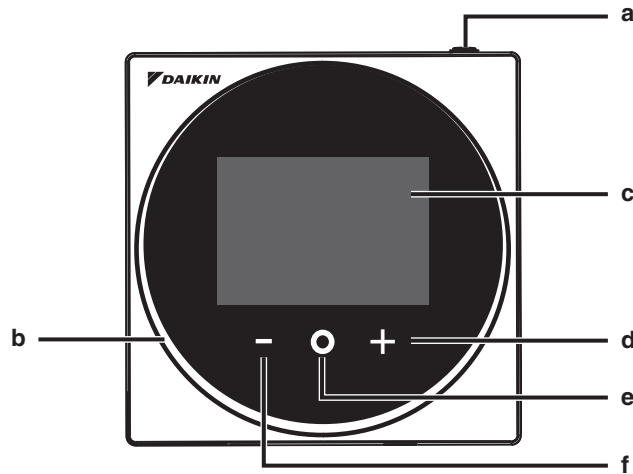

2.2 BRC1H71W

2.2.1 Button Locations and Descriptions



- a**  **ON/OFF button**
- Press this button to turn on the system.
 - Press this button again to turn off the system.
- b** **Status indicator (LED)**
- During operation, the light ring around the display lights up blue/red/green.
Lights up blue: Operating, Blinks red: Error is occurring, Lights up/blinks green: Bluetooth connecting
- c** **LCD**
- Displays the current setpoint and air conditioner operation status.
- d**  **NAVIGATE/ADJUST button**
- Navigate right.
 - Adjust a setting.
- e**  **SELECT/ACTIVATE/SET button**
- From the home screen, enter the user menu.
 - From the user menu, enter one of the submenus.
 - From their respective submenu, activate an operation/ventilation mode.
- f**  **NAVIGATE/ADJUST button**
- Navigate left.
 - Adjust the setting.

2.2.2 Overview of Screens

The following is just an example. The items available for setting vary depending on the indoor unit you are using. If there is no button operation for about 10 seconds, the screen returns to the home screen.

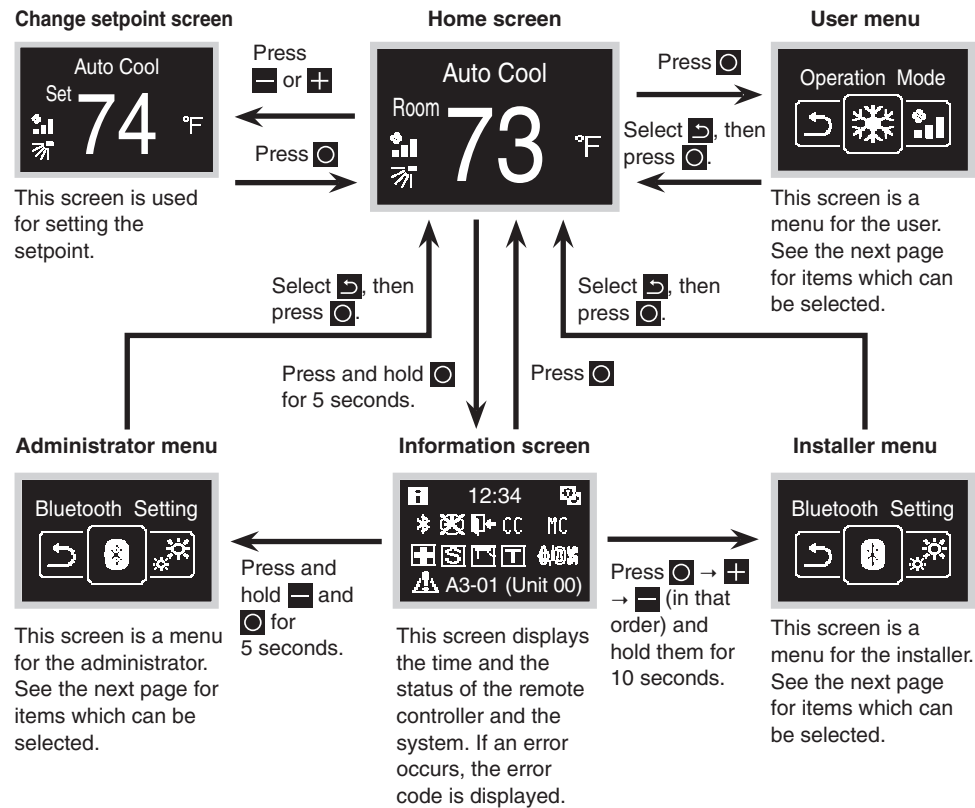





There are 2 screen display modes, text mode and icon mode.

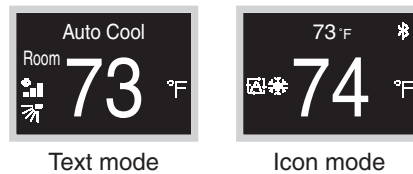











Change the mode according to your preference.

* All of the above explanations are shown with screens from text mode.



2.2.3 Setting Screen List

Setting list			User menu	Administrator menu	Installer menu
Icon	Name	Description			
Depends on current setting	Operation Mode	Operation mode setting	●		
Depends on current setting	Fan Speed	Airflow rate setting	●		
Depends on current setting	Airflow Direction	Airflow direction 1 setting	●		
Depends on current setting	Vertical Airflow	Airflow direction 2 setting	●		
Depends on current setting	Ventilation Mode	Ventilation mode setting	●		
Depends on current setting	Ventilation Rate	Ventilation rate setting	●		
	Adjust LED (ON)	LED brightness adjustment when backlight lights up	●		
	Adjust LED (OFF)	LED brightness adjustment when backlight lights up dimly	●		
	Celsius/Fahrenheit	Fahrenheit/Celsius changeover	●		
	Setpoint	Setpoint setting when in auto operation mode	●		
	Sign Reset	Filter sign reset	●		

Setting list			User menu	Administrator menu	Installer menu
Icon	Name	Description			
	Bluetooth Setting	Bluetooth setting		●	●
	Backlight	Backlight brightness setting		●	●
	Contrast	Contrast setting		●	●
	Clock Setting	Clock setting		●	●
	Standard Temp	Scale reference temperature setting		●	●
	About	Administrator information		●	●
	Admin Password	Administrator password setting		●	
	Installer Password	Installer password setting			●
	Field Setting	Field Setting			●
	R/C Setting	R/C Setting			●
	Address Setting	Address Setting			●
	Forced Fan ON	Forced Fan ON Setting			●
	Rel Master Control	Release changeover master			●

2.2.4 Names and Functions

Home screen

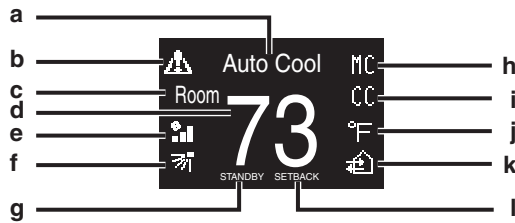

Information screen

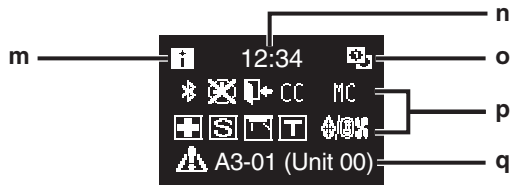

User menu/Administrator menu/Installer menu

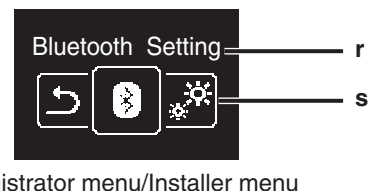
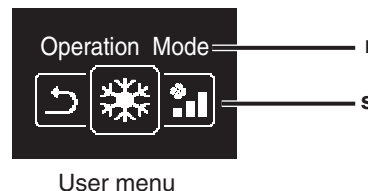

The Bluetooth® word mark and logos are registered trademarks owned by the Bluetooth SIG, Inc. and use of such marks by Daikin industries, LTD. is under license. Other trademarks and trade names are those of their respective owners.

Screen display explanation

- a Operation mode/OFF display**
 - Displays the operation status.
- b Error/Filter/Test icon**
 - Error, filter and test icons are displayed.
- c Room/Set**
 - Indicates whether it's a room temperature display (Room) or setpoint display (Set).
- d Room temperature/Set temperature**
 - Displays the current room or setpoint temperature.
- e Fan speed**
 - Displays the set fan speed.
- f Airflow direction**
 - Displays the set airflow direction.
- g STANDBY**
 - Displays during defrost/hot start.
- h Changeover controlled by the master indoor unit**
 - Displayed when another indoor unit on the system has the authority to change the operation mode between cool and heat.
- i Under centralized control**
 - Displayed if the system is under the management of a multi-zone controller (Optional) and the operation of the system through the remote controller is limited.
- j Fahrenheit/Celsius**
 - Depending on the setting, Fahrenheit/Celsius display can be selected.
- k Ventilation operation/Air Purify**
 - Displayed when a Heat Reclaim Ventilator is connected.
- l Setback**
 - Blinks during setback operation.
 - Displayed during setback setting.
- m Information icon**
- n Clock (24 hours time display)**
- o MAIN/SUB remote controller sign**
- p Status**
 - Notifies the status.
- q Error display**
 - If an error occurs, the icon, an error code and unit number are displayed.
- r Settings menu name**
- s Settings menu icon**

i INFORMATION

Depending on the connected model, some items may not be displayed. The controller is equipped with a power-saving function that darkens the display if there is no operation for a certain period of time. To make the screen light up again, press one of the buttons. Note that pressing one of the buttons will only make the display bright again, not cause remote controller operation.

* All screens shown are from text mode.

Home screen list

There are 4 types of home screen.

The home screen type can be changed by the remote controller setting.

Text mode

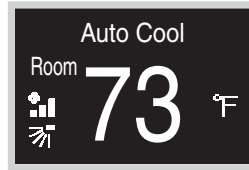

Icon mode



Text mode (Scale screen)

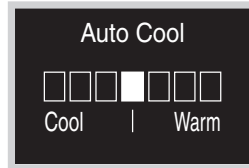

Icon mode (Scale screen)

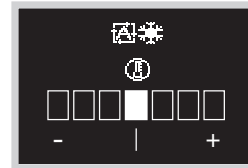

When in the scale screen, the setpoint can be changed in the range of $\pm 3^{\circ}\text{C}/^{\circ}\text{F}$ of the reference temperature.

The reference temperature can be changed from the smartphone application or the remote controller (from the administrator menu).

2.2.5 Information Screen

The functions of the connected indoor unit are displayed as icons.

How to display the information screen

Home screen

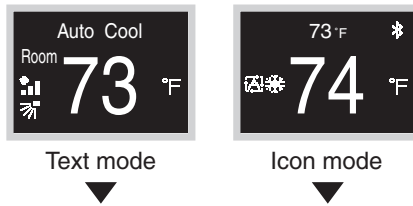

Press and hold  on the Home screen for 5 seconds.

Information screen



The screen switches to the Information screen.

How to exit the information screen

Information screen

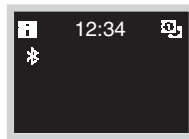

Press  or there is no button operation for about 10 seconds, the screen returns to the home screen.

About icons on the information screen









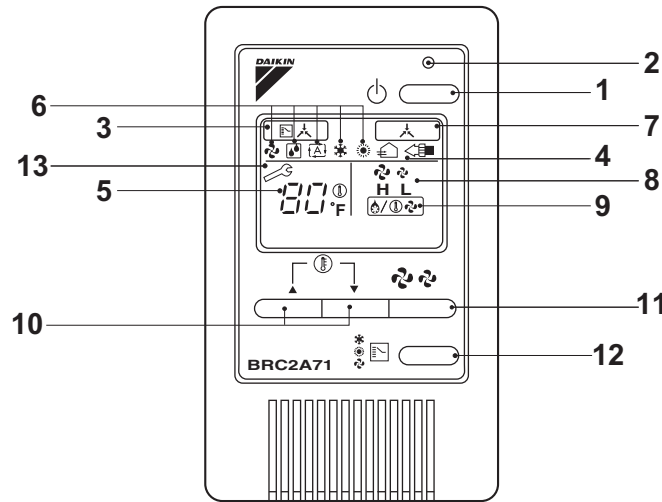

The items displayed vary depending on the indoor unit you are using.





Icon	Name	Description
	Information	Indicates an information screen.
	MAIN/SUB remote controller	Displayed when used as the MAIN/SUB remote controller. 1=main, 2=sub
	Bluetooth*	Indicates that the controller is communicating with a mobile device, for use with the app.
	Clock not set	Indicates that the clock needs to be set again.
	Setback	Indicates that the indoor unit is operating under setback conditions.
	Under centralized control	Indicates that the system is controlled by central control equipment (optional accessory) and that control of the system by the controller is limited.
	Changeover controlled by the master indoor unit	<p>Displayed: The remote controller does not have master control. Unable to select heating/cooling operation.</p> <p>Blinking: None of the remote controllers in the system have master control. Can be set as the master controller during this time.</p> <p>Not Displayed: The remote controller has master control. Able to select heating/cooling operation.</p>
	Backup	Indicates that backup operation is being carried out.
	Energy savings	Indicates that the system's energy consumption is being limited, and that it is running with restricted capacity.
	Individual airflow direction	Indicates that the individual airflow direction setting is enabled.
	Test operation	Indicates that Test Operation mode is active.
	Stand by for Defrost/Hot start	Indicates that the defrost/hot start mode is active.
	Self-cleaning filter operation	Indicates that self-cleaning filter operation is active.
	Inspection	Indicates that the indoor or outdoor unit is being inspected.
	Periodic inspection	Indicates that the indoor or outdoor unit is being inspected.
	Ventilating operation	Indicates that ventilating operation is being carried out.
	Warning	Indicates that an error occurred, or that an indoor unit component needs to be maintained.

* The Bluetooth® word mark and logos are registered trademarks owned by the Bluetooth SIG, Inc. and use of such marks by Daikin industries, LTD. is under license. Other trademarks and trade names are those of their respective owners.

2.3 Simplified Remote Controller



1	ON/OFF BUTTON
	Press the button and the system will start. Press the button again and the system will stop.
2	OPERATION LAMP (RED)
	The lamp lights up during operation. Blinks in case of stop due to malfunction.
3	DISPLAY “” (CHANGEOVER UNDER CONTROL)
	It is impossible to changeover heating/cooling with the remote controller when it shows this display. (As for details, see “SETTING OF MASTER REMOTE CONTROLLER” in the installation manual attached to the indoor unit.)
4	DISPLAY “” (VENTILATION/AIR CLEANING)
	This display shows that the total heat exchanger and the air cleaning unit are in operation. (These are optional accessories).
5	DISPLAY “” (SET TEMPERATURE)
	This display shows the set temperature. Only given during a cooling or heating operation.
6	DISPLAY “” “” “” “” “” (OPERATION MODE)
	This display shows current OPERATION MODE. “  ” is not available with outdoor units specially designed for cooling only. “  ” is reserved only for outdoor units capable of heat recovery.

7	DISPLAY “” (UNDER CENTRALIZED CONTROL)
	When this display shows, the system is UNDER CENTRALIZED CONTROL. (This is not a standard specification)
8	DISPLAY “” (FAN SPEED)
	This display shows the fan speed: HIGH or LOW.
9	DISPLAY “” (DEFROST / HOT START)
	Indicates that defrost or hot start (during which the fan is stopped until the temperature of air supply rises enough at the start of a heating operation) is in progress.
10	TEMPERATURE SETTING BUTTON
	Use this button for SETTING TEMPERATURE of the thermostat. ▲ ; Each press raises the set temperature by 1°F. ▼ ; Each press lowers the set temperature by 1°F. The variable temperature range is between 60°F and 90°F.
11	FAN SPEED CONTROL BUTTON
	Press this button to select the fan speed, HIGH or LOW, of your choice.
12	OPERATION MODE SELECTOR BUTTON
	Press this button to select OPERATION MODE.
13	DISPLAY “” (MALFUNCTION)
	Indicates malfunction and blinks if the unit stops operating due to malfunction. (As for details, see “TROUBLE SHOOTING” in the operation manual attached to the outdoor unit.)

2.4 Wireless Remote Controller

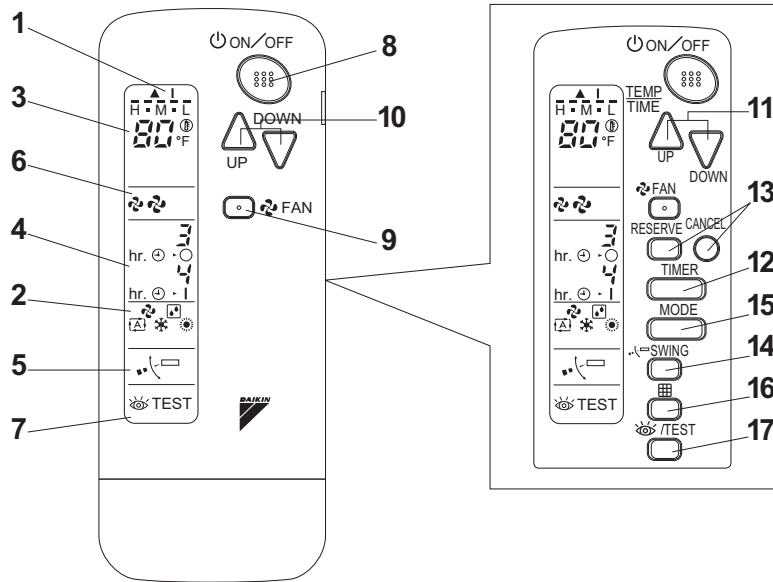

Receiver

FHQ

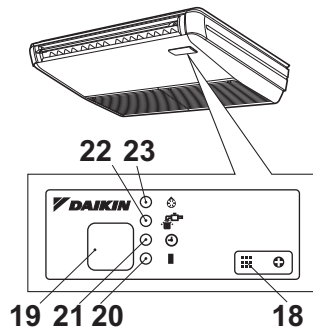



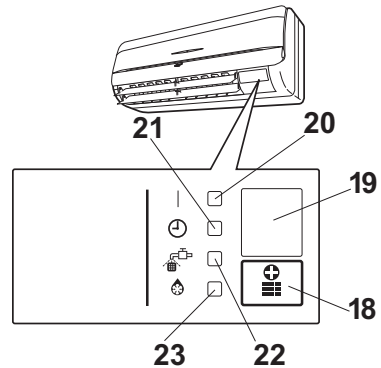



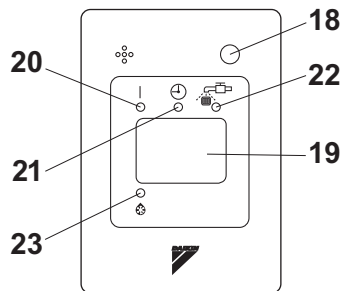





FAQ



FBQ (separate type)



1	DISPLAY “▲” “I” (SIGNAL TRANSMISSION)
	This lights up when a signal is being transmitted.
2	DISPLAY “” “” “” “” “” “” (OPERATION MODE)
	This display shows the current OPERATION MODE.
3	DISPLAY “” (SET TEMPERATURE)
	This display shows the set temperature.
4	DISPLAY “ hr. 0-3” “ hr. 0-1” (PROGRAMMED TIME)
	This display shows PROGRAMMED TIME of the system start or stop.
5	DISPLAY “” (AIR FLOW FLAP)
6	DISPLAY “” “” (FAN SPEED)
	This display shows the set fan speed.
7	DISPLAY “TEST” (INSPECTION/ TEST OPERATION)
	When the INSPECTION/TEST OPERATION BUTTON is pressed, the display shows the system mode is in.
8	ON/OFF BUTTON
	Press the button and the system will start. Press the button again and the system will stop.
9	FAN SPEED CONTROL BUTTON
	Press this button to select the fan speed, HIGH or LOW, of your choice.
10	TEMPERATURE SETTING BUTTON
	Use this button for SETTING TEMPERATURE. (Operates with the front cover of the remote controller closed.)

11	PROGRAMMING TIMER BUTTON
	Use this button for programming “START and/or STOP” time. (Operates with the front cover of the remote controller opened.)
12	TIMER MODE START/STOP BUTTON
13	TIMER RESERVE/CANCEL BUTTON
14	AIR FLOW DIRECTION ADJUST BUTTON
15	OPERATION MODE SELECTOR BUTTON
	Press this button to select OPERATION MODE.
16	FILTER SIGN RESET BUTTON
	Refer to the section of MAINTENANCE in the operation manual attached to the indoor unit.
17	INSPECTION/TEST OPERATION BUTTON
	This button is pressed for inspection or test operation. Do not use for normal operation.
18	EMERGENCY OPERATION SWITCH
	This switch is readily used if the remote controller does not work.
19	RECEIVER
	This receives the signals from the remote controller.
20	OPERATING INDICATOR LAMP (Red)
	This lamp stays lit while the air conditioner runs. It flashes when the unit is in trouble.
21	TIMER INDICATOR LAMP (Green)
	This lamp stays lit while the timer is set.
22	AIR FILTER CLEANING TIME INDICATOR LAMP (Red)
	Lights up when it is time to clean the air filter.
23	DEFROST LAMP (Orange)
	Lights up when the defrosting operation has started. (For cooling only type this lamp does not turn on.)

3. Main/Sub Setting

Main/Sub setting is necessary when 1 indoor unit is controlled by 2 remote controllers. The remote controllers are set at factory to Main, so you have to change one remote controller from Main to Sub. To change a remote controller from Main to Sub, proceed as follows:

3.1 Wired Remote Controller (BRC1E73)

3.1.1 Field Settings

The designation of the main and sub remote controllers can be swapped. Note that this change requires turning the power OFF and then ON again.

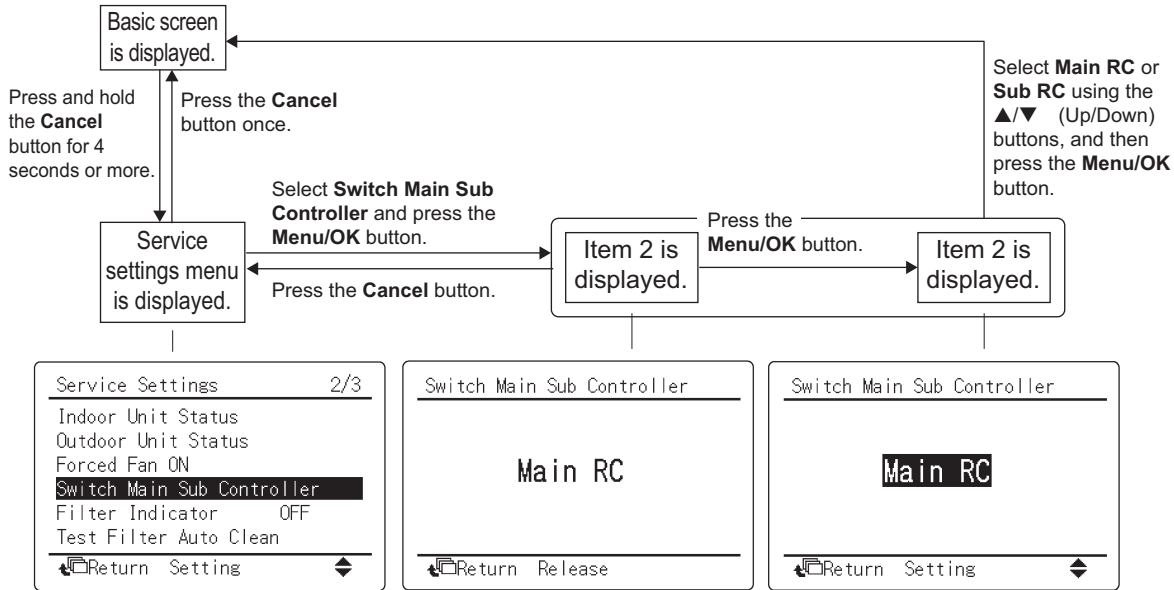

3.1.2 When an Error Occurred

U5: there are 2 main remote controllers when power is turned ON

→Change the setting from Main to Sub on the remote controller you want to be Sub.

U8: there are 2 sub remote controllers when power is turned ON

→Change the setting from Sub to Main on the remote controller you want to be Main.

How to confirm Main/Sub setting

The Main/Sub setting of the remote controller is displayed on the bottom of the screen while **Checking the connection. Please stand by.** is displayed.

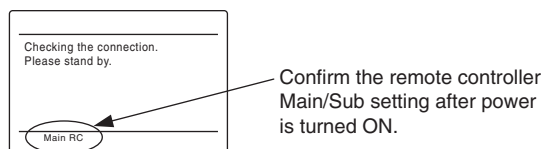

How to change Main/Sub setting

You may change the Main/Sub setting of the remote controller while **Checking the connection. Please stand by.** is displayed by pressing and holding the **Mode Selector** button for 4 seconds or longer.

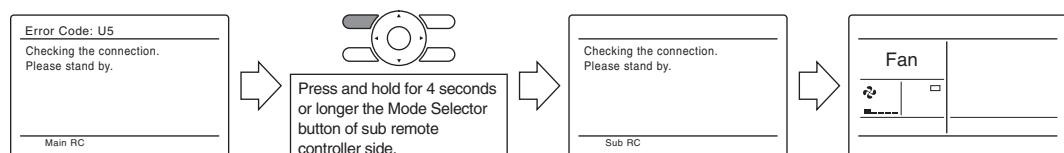

**Note(s)**

1. It is not possible to change the Main/Sub setting from Main to Sub when only one remote controller is connected.
2. When 2 remote controllers are being used, it is not possible to change the setting from Main to Sub if one of the remote controllers is already set as Main.

3.2 Wired Remote Controller (BRC1H71W)

3.2.1 Main and Sub Controller

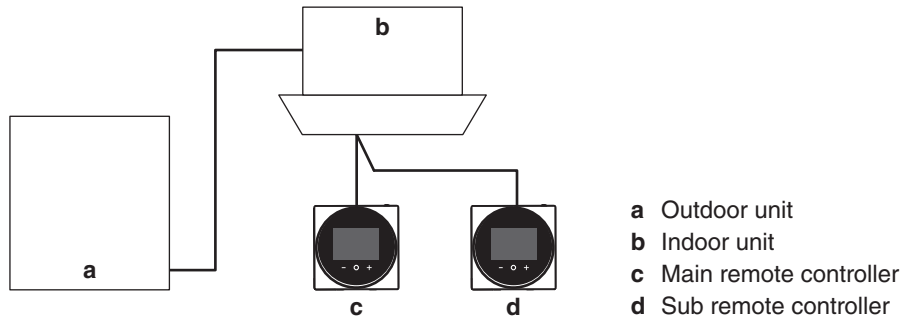

- On the information screen, main/sub status is indicated by the following icons:

Icon	Description
	Main
	Sub

INFORMATION

It is only possible to use a main and a sub controller of the same type.

INFORMATION

If a sub controller does not display the home screen 2 minutes after its designation, turn off the power and check the wiring.

INFORMATION

After re-designating a controller, the system requires a power reset.

INFORMATION

The following functions are not available for sub controllers:

- “Auto” operation mode
- Individual airflow direction
- Filter auto clean
- Setback temperature setpoints
- Draft prevention

3.2.2 Designating a Controller as Main or Sub

Prerequisite: A remote controller is already connected to the indoor unit.

Connect a second controller.

After turning on the power, perform setting of the second controller.

Result: It will start up automatically.



Home screen



Wait for a U5 or U8 error code to appear on the screen.

Screen display explanation

1 main

2 sub



Home screen



When the U5 error code appears, press  and hold until "2" appears on the screen.

When the U8 error code appears, press  and hold until "1" appears on the screen.

Result:

A controller displaying 1 is set as main, and a controller displaying 2 is set as sub.



INFORMATION

If sub remote controller is not set at power-on in the case of one indoor unit controlled by two remote controllers, Error Code: U5 is displayed in the connection checking screen.

If the sub remote controller does not display the home screen two minutes after its designation, turn off the power and check the wiring.

3.3 When Wireless Remote Controller is Used Together

When using both a wired and a wireless remote controller for 1 indoor unit, the wired controller should be set to Main. Therefore, the Main/Sub switch (SS1) of the signal receiver PCB must be set to Sub.

Main/Sub	Main	Sub
Main/Sub switch (SS1)		

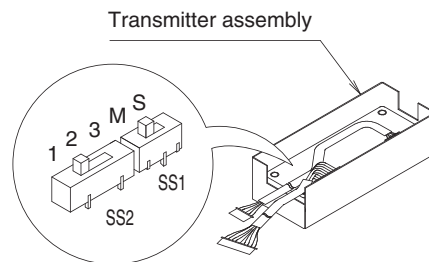
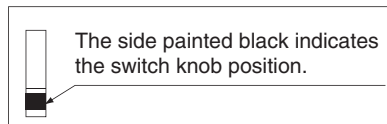

4. Address Setting for Wireless Remote Controller



If setting multiple wireless remote controllers to operate in one room, perform address setting for the receiver and the wireless remote controller.

(This includes an individual remote controller control using the group operation.)

(For the wiring for the group operation, please refer to the installation manual attached to the indoor unit and technical guide.)

Setting for Signal Receiver PCB

The address for the receiver is set to 1 at the factory. To change the setting, set the wireless address switch (SS2) on the signal receiver PCB according to the table below.

Unit No.	No. 1	No. 2	No. 3
Wireless address switch (SS2)			

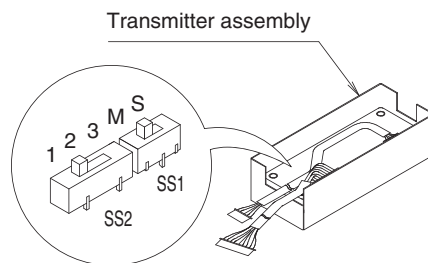
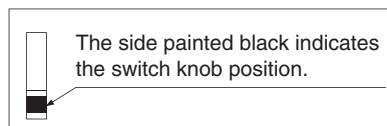

Setting for Wireless Remote Controller

The address for the wireless remote controller is set to 1 at the factory. To change the setting, proceed as follows:

1. Press **FILTER SIGN RESET** button and **INSPECTION/TEST** button at the same time for 4 seconds to enter field setting mode. (**SETTING** is indicated on the display.)
2. Press **FAN** button and select **A** or **b**. Each time the button is pressed, the display switches between **A** and **b**.
3. Press **UP** button or **DOWN** button to select an address from 1-3 as same as the receiver. Address can be set from 1-6, but the receiver does not work with addresses 4-6.

← 1 → 2 → 3 → 4 → 5 → 6

4. Press **RESERVE** button to confirm the setting.
5. Press **INSPECTION/TEST** button for 1 second to return to normal mode.

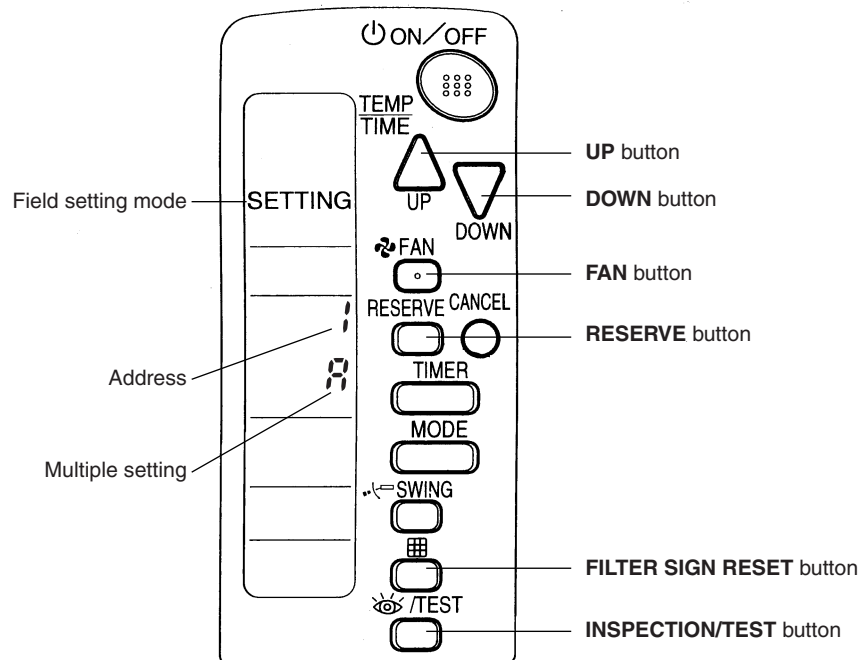

Multiple Settings A/b

The command such as operation mode or temperature setting by this remote controller will be rejected when the target indoor unit operation is restricted as by an external control such as centralized control.

Since the setting acceptance is hard to discriminate with such circumstances there are two setting options provided to enable discriminating by a beeping sound according to the operation: "A: Standard" or "b: Multi System". Set the setting according to the customer's intention.

Remote Controller		Indoor Unit	
Multiple setting	Display on remote controller	Behavior to the remote controller operation when the functions are restricted as by an external control.	Other than the left
A: Standard (factory set)	All items displayed.	Accepts the functions except restricted. (Sounds one long beep or three short beeps) There may be a difference from the indoor unit status with remote controller display.	Accepts all items transmitted (Sounds two short beeps) The remote controller display agrees with the indoor unit status.
b: Multi System	Display only items transmitted for a while.	<p><When some restricted functions are included in the transmitted items> Accepts the functions except restricted. (Sounds one long beep or three short beeps) There may be a difference from the indoor unit status with remote controller display.</p> <p><When no restricted function is included> Accepts all items transmitted (Sounds two short beeps) The remote controller display agrees with the indoor unit status.</p>	

5. Centralized Control Group No. Setting

5.1 BRC1E73

In order to conduct the centralized remote control using the central remote controller and the unified ON/OFF controller, Group No. settings should be made by group using the operating remote controller.

Make Group No. settings for centralized remote control using the operating remote controller.

When initializing Group Address

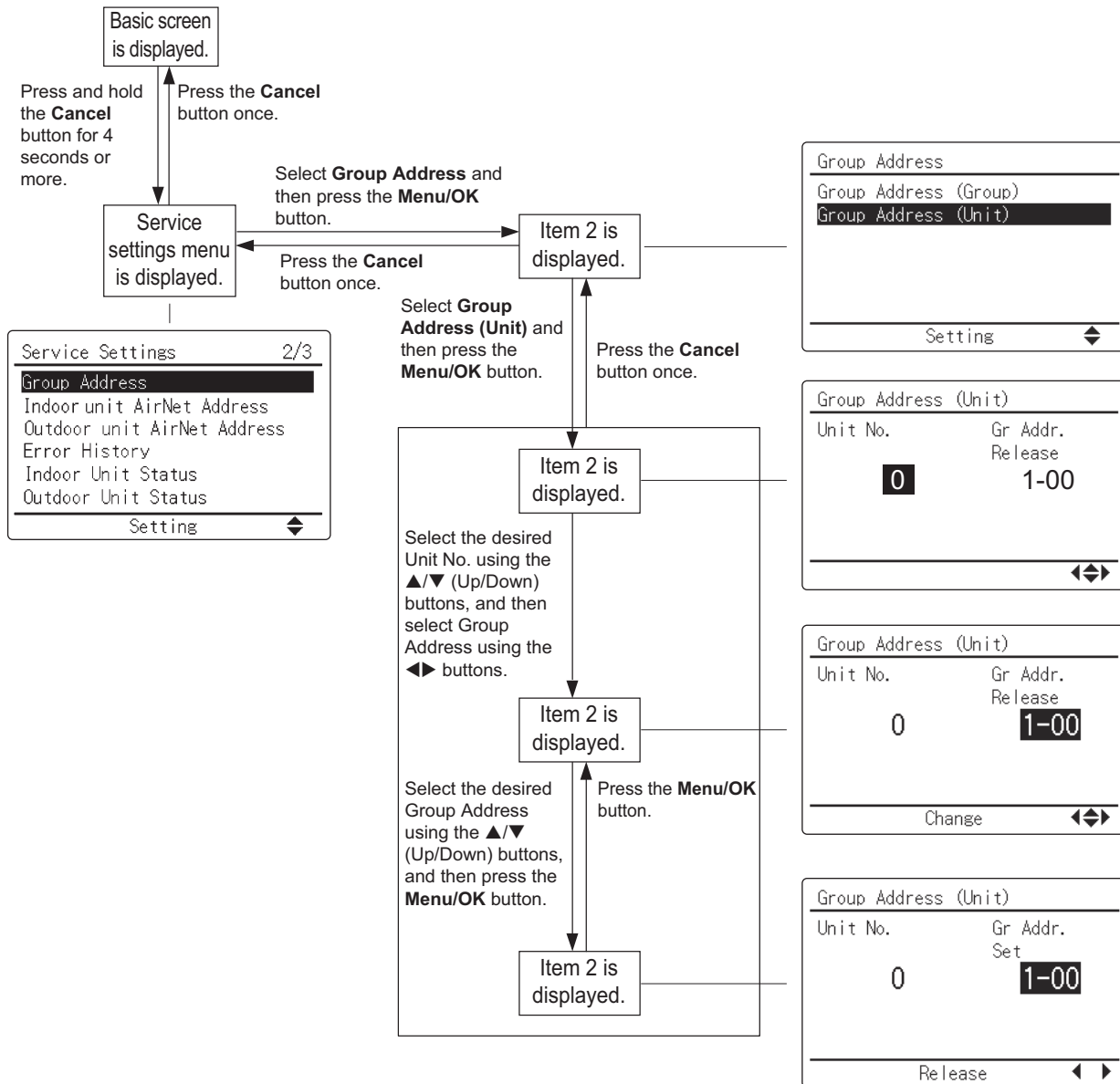

Service settings menu	Item 2
Group Address	Group Address (Group)
	Group Address (Unit)

Description

This menu is used to make group address setting for centralized control. It is also used to make group address setting by indoor unit.



Note(s)

- For setting group No. of Energy recovery ventilator and wiring adaptor for other air conditioners, etc., refer to the instruction manual.

NOTICE

Enter the group No. and installation place of the indoor unit into the installation table. Be sure to keep the installation table with the operation manual for maintenance.

Group Address (Group)

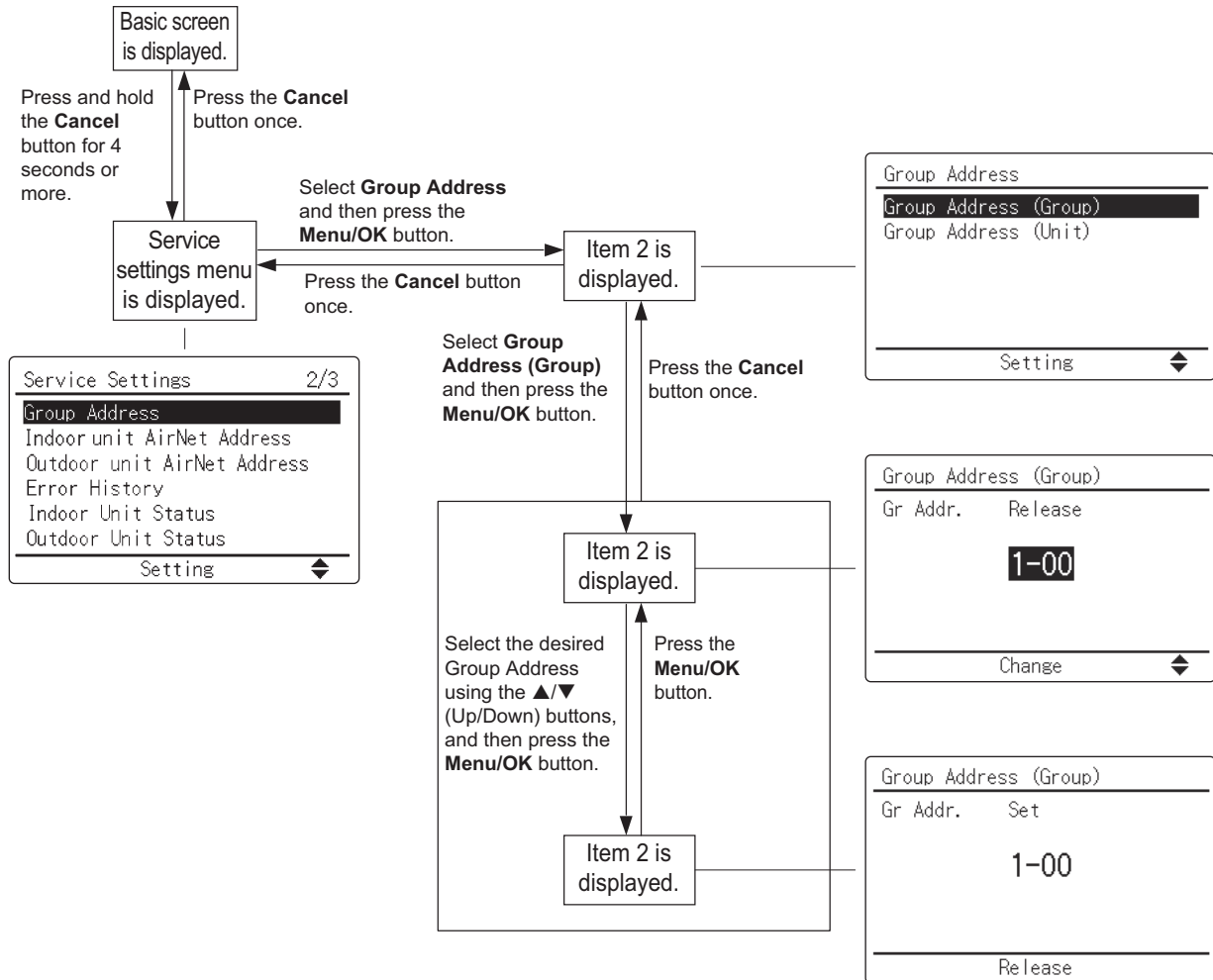

5.2 BRC1H71W

Group Address

- Assign the group address and unit number for centralized control.
- The group and unit address can only be set when a centralized controller is connected.
This menu is only visible when a centralized controller is connected.
- The group and unit address can be “set” and “released”.

NOTICE

Don't forget to release the group address before disconnecting the centralized controller because the menu will not be accessible afterwards.

Manual setting mode

- Installer setting
- RC settings
- Maintenance

Group address setting
Main

Set the indoor unit group address.
After all settings are complete, press the “Send to RC” button.

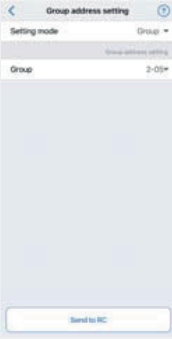

Manual setting mode

- Installer setting
- RC settings
- Maintenance

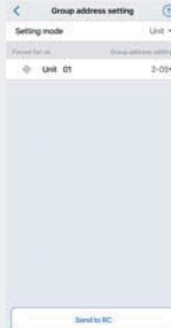

▶ **Setting mode**
You can switch between setting the indoor unit group address for each group, or for each unit.

Manual setting mode

- Installer setting
- RC settings
- Maintenance

▶ **Group**
Set the group address on a per-group basis.
* Set a group address only for the MAIN unit.

▶ **Unit**
Set the group address on a per-unit basis.

▶ **Forced fan on**
Force operation of the fan of the unit number whose icon has been tapped. You can confirm the location of the device on which you are performing settings.

5.3 Wireless Remote Controller

Group No. setting by wireless remote controller for centralized control

1. When in the normal mode, press **INSPECTION/TEST** button for 4 seconds or more to enter field setting mode.
2. Set mode No. 00 with **MODE** button.
3. Set the group No. for each group with **UP** button or **DOWN** button.
4. Enter the selected group numbers by pressing **RESERVE** button.
5. Press **INSPECTION/TEST** button and return to the normal mode

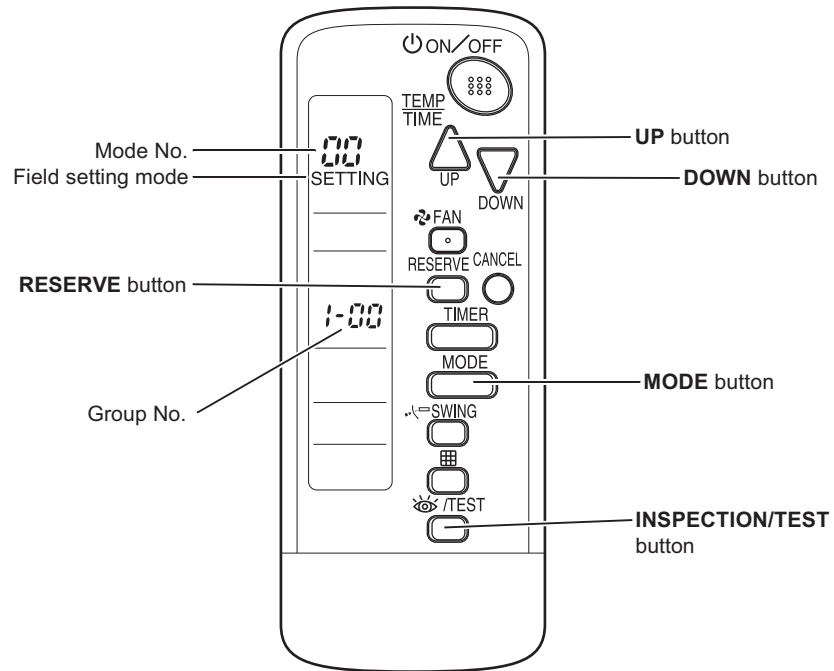

6. Service Settings Menu, Maintenance Menu

6.1 BRC1E73

Operating the remote controller allows service data to be acquired and various services to be set.

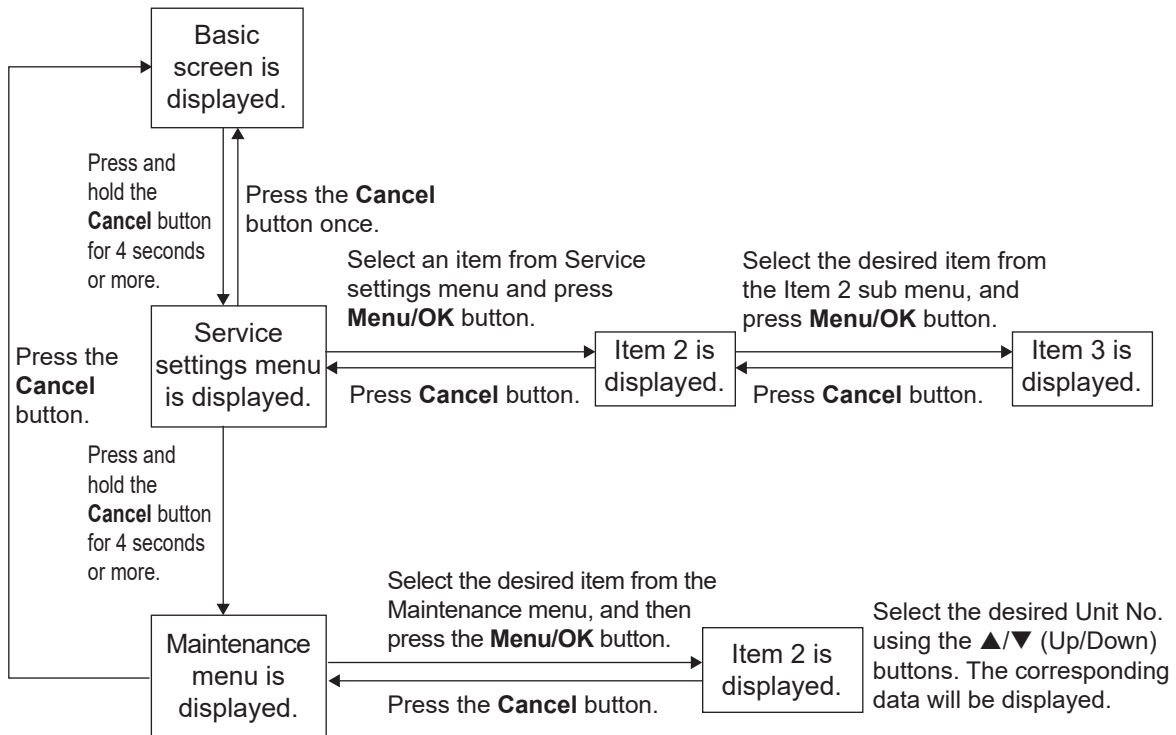

6.1.1 Service Settings Menu

Service settings menu	Item 2	Item 3
Test Operation	—	—
Maintenance Contact	None	—
	Maintenance Contact	—, 0 to 9 (in order)
Field Settings	Indoor Unit No.	—
	Mode No.	—
	First Code No.	—
	Second Code No.	—
Energy Saving Options	Setpoint Range Limitation	Temperature
	Setback Configuration	Recovery Differential
	Auto-setback by Sensor	Enable/Disable, Settings
	Auto-off by Sensor	Enable/Disable, Auto-off in (hours)
Prohibit Function	Prohibit Buttons	Up/Down, Left, Right, On/Off, Mode, Fan Speed
	Prohibit Mode	Fan, Cool, Heat, Auto, Dry, Vent Clean
Min Setpoints Differential	None, Single SP, 0 to 8°F	—
Group Address	Group Address (Group)	Gr Addr. Set
	Group Address (Unit)	Unit No., Gr Addr. Set
Indoor unit AirNet Address	Unit No., Address Set	—
Outdoor unit AirNet Address	Unit No., Address Set	—
Error History	RC Error History	Unit No., Error, Date, Time (Up to 10 errors received by the remote controller can be displayed.)
	Indoor unit Error History	Unit No., Error, Date, Time (Up to 5 errors from the indoor unit error record can be displayed.)
Indoor Unit Status	Unit No.	—
	Th1	Suction air thermistor
	Th2	Heat exchanger liquid pipe thermistor
	Th3	Heat exchanger gas pipe thermistor
	Th4	Discharge air thermistor
	Th5	Remote controller thermistor (FBQ, FTQ) Floor temperature thermistor (FCQ)
	Th6	Control temperature thermistor (FBQ, FCQ, FTQ)
Outdoor Unit Status	Unit No.	—
	Th1	—
	Th2	—
	Th3	—
	Th4	—
	Th5	—
	Th6	—
Forced Fan ON	Unit No.	—
Switch Main Sub Controller	—	—
Filter Indicator	—	—
Test Filter Auto Clean	—	—
Brush/Filter Ind.	—	—
Disable Filter Auto Clean	No, Yes	—

6.1.2 Maintenance Menu

Maintenance Menu	Item 2	Remarks
Model Name	Unit No.	Select the unit number you want to check.
	Indoor unit	The model names are displayed. (A model code may be displayed instead, depending on the particular model.)
	Outdoor unit	
Operation Hours	Unit No.	Select the unit number you want to check.
	Indoor unit operation hours	All of these are displayed in hours.
	Indoor fan operation hours	
	Indoor unit energized hours	
	Outdoor unit operation hours	
	Outdoor fan 1 operation hours	
	Outdoor fan 2 operation hours	
	Outdoor compressor 1 operation hours	
	Outdoor compressor 2 operation hours	
Indoor Unit Status	Unit No.	
	FAN	Fan tap (*1)
	Speed	Fan speed (rpm)
	FLAP	Swing, fixed
	EV	Degree that electronic expansion valve is open (pulse)
	MP	Drain pump ON/OFF
	EH	Electric heater ON/OFF
	Hu	Humidifier ON/OFF (*2)
	TBF	Anti-freezing control ON/OFF
	FLOAT	Float switch OPEN/CLOSE
	T1/T2	T1/T2 external input OPEN/CLOSE
	Th1	Suction air thermistor
	Th2	Heat exchanger liquid pipe thermistor
	Th3	Heat exchanger gas pipe thermistor
	Th4	Discharge air thermistor
	Th5	Remote controller thermistor (FBQ, FTQ) Floor temperature thermistor (FCQ)
	Th6	Control temperature thermistor (FBQ, FCQ, FTQ)
Outdoor Unit Status	Unit No.	Select the Unit No. you want to check.
	FAN step	Fan tap
	COMP	Compressor power supply frequency (Hz)
	EV1	Degree that electronic expansion valve is open (pulse)
	SV1	Solenoid valve ON/OFF
	Th1	—
	Th2	—
	Th3	Te: Low pressure equivalent saturation temperature
	Th4	Tc: High pressure equivalent saturation temperature
	Th5	—
Th6	—	
Forced Defrost	Forced defrost ON	Enables the forced defrost operation.
	Forced defrost OFF	Disables the forced defrost operation.

Maintenance Menu	Item 2	Remarks
Error Display	Display error ON	Displays the error on the screen.
	Display error OFF	Displays neither errors nor warnings.
	Display warning ON	Displays a warning on the screen if an error occurs.
	Display warning OFF	No warning is displayed.
Swap Unit No.	Current Unit No.	A unit No. can be transferred to another.
	Transfer Unit No.	
Addressed Sensor Value	Unit No.: 0 - 15	Select the unit number you want to check.
	Code	00: Remote controller thermistor (°C) 01: Suction air thermistor (°C) 02: Heat exchanger liquid pipe thermistor (°C) 03: Heat exchanger gas pipe thermistor (°C) 04: Indoor unit address No. 05: Outdoor unit address No. 06: Branch selector unit address No. 07: Zone control address No. 08: Cooling/Heating batch address No. 09: Demand/low-noise address No.
	Data	The corresponding data will be displayed, based on the unit number and Code selected.

- *1. (For FTQ-TA models)
The actual fan speed is converted into the fan tap to be displayed. Therefore, if the fan speed is changed by controls or external factors, the airflow rate set with the remote controller may differ from the fan tap display.
- *2. (For FTQ-TA models)
The ON/OFF status of the humidifier connected to HUMIDIFIER on the X1M terminal of the indoor unit PCB is not displayed. The ON/OFF status of the humidifier connected to the wiring adaptor is displayed.

6.2 Wireless Remote Controller

6.2.1 Service Setting

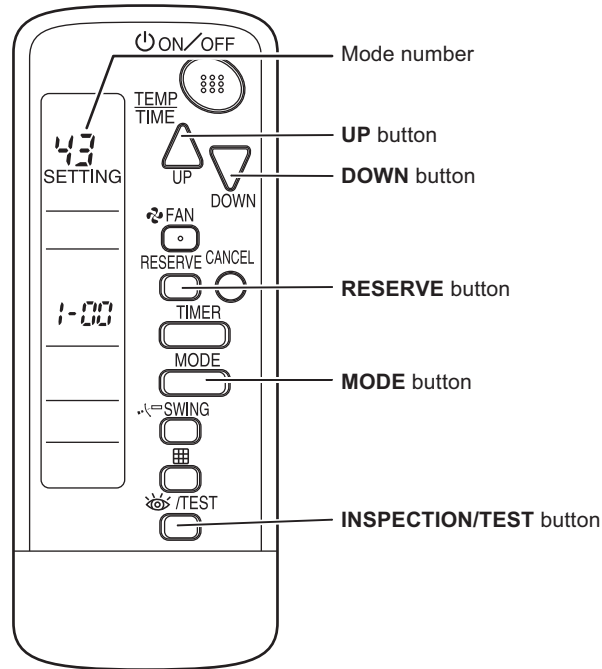

1. Press **INSPECTION/TEST** button for 4 seconds during normal mode to enter field setting mode.
2. Press **INSPECTION/TEST** button for 4 seconds to enter service mode.
3. Press **MODE** buttons to select a desired mode number. (43)
4. Carry out the necessary setting with **UP** button or **DOWN** button.
5. Press **RESERVE** button to confirm the setting.
6. Press **INSPECTION/TEST** button to return to normal mode

Mode No.	Function	Content and Operation Method	Example of Remote Controller Display
43	Forced Fan ON	Turns the fan ON for each unit individually.	UNIT No. : 43 SETTING

7. Administrator Menu, Installer Menu

7.1 BRC1H71W

Refer to page 114 for details.

Part 4

Functions and Control

1. Operation Mode	141
2. Basic Control	142
2.1 Normal Operation	142
2.2 Compressor PI Control	143
2.3 Electronic Expansion Valve PI Control	145
2.4 Cooling Operation Fan Control	145
3. Special Control	146
3.1 Startup Control	146
3.2 Oil Return Control	148
3.3 Defrost Control	150
3.4 Pump Down Residual Control	151
3.5 Restart Standby	152
3.6 Stop Control	152
4. Protection Control	153
4.1 High Pressure Protection Control	153
4.2 Low Pressure Protection Control	154
4.3 Discharge Pipe Temperature Protection Control	155
4.4 Inverter Protection Control	156
5. Other Control	158
5.1 Demand Operation	158
5.2 Heating Operation Prohibition	158
6. Outline of Control (Indoor Unit)	159
6.1 Remote Controller Thermistor	159
6.2 Thermostat Control	161
6.3 Thermostat Control with Operation Mode Set to AUTO	163
6.4 List of Swing Flap Operations	164
6.5 Hot Start Control (In Heating Operation Only)	165
6.6 Louver Control for Preventing Ceiling Dirt (FCQ Models Only)	166
6.7 Drain Pump Control	167
6.8 Freeze-Up Prevention	169
6.9 Heater Control (Except FTQ-TA Models)	171
6.10 Heater Control (FTQ-TA Models)	172
6.11 3-Step Thermostat Processing (FTQ-TA Models)	175
6.12 Fan Control (Heater Residual) (FTQ-TA Models)	176
6.13 Interlocked with External Equipment (FTQ-TA Models)	176

1. Operation Mode

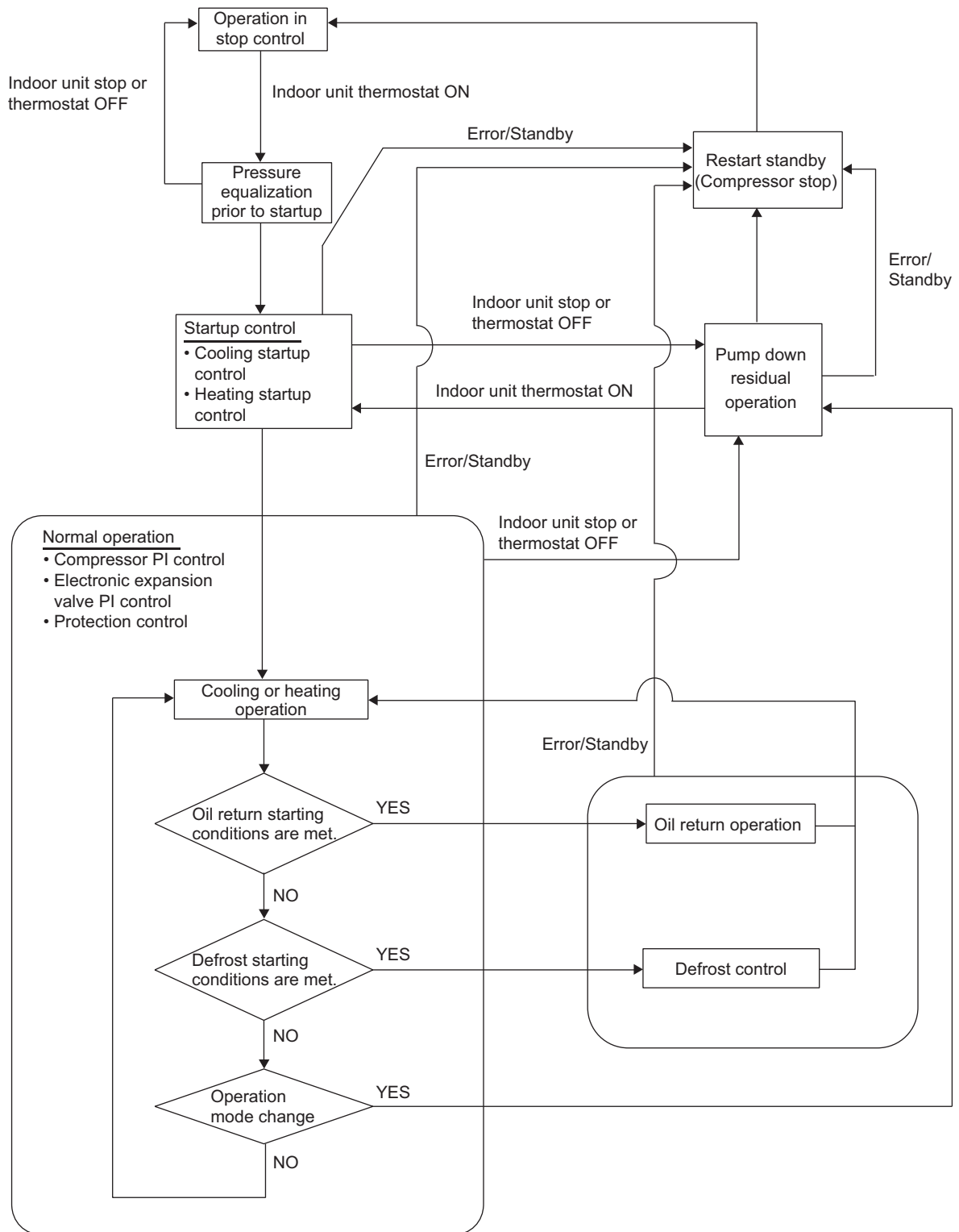

i Note(s) In the event that the indoor unit stops or the thermostat turns OFF while in oil return operation or defrost control, pump down residual operation is performed on completion of the oil return operation or defrost control.

2. Basic Control

2.1 Normal Operation

Cooling Operation

Outdoor unit actuator	Electric Symbol		Operation	Remarks
	18/24 class	30-48 class		
Compressor	M1C	M1C	Compressor PI control	Used for high pressure protection control, low pressure protection control, discharge pipe temperature protection control, and compressor operating frequency upper limit control with inverter protection control.
Outdoor fan	M1F	M1F M2F	Cooling fan control	—
Electronic expansion valve (Main)	Y1E	Y1E	480 pulse	—
Electronic expansion valve (Subcooling)	—	Y3E	PI control	—
Four way valve	Y1S	Y1S	OFF	—
Hot gas bypass valve	Y2S	—	OFF	This valve turns ON with low pressure protection control.

Heating Operation

Outdoor unit actuator	Electric Symbol		Operation	Remarks
	18/24 class	30-48 class		
Compressor	M1C	M1C	Compressor PI control	Used for high pressure protection control, low pressure protection control, discharge pipe temperature protection control, and compressor operating frequency upper limit control with inverter protection control.
Outdoor fan	M1F	M1F M2F	Step 7 or 8	—
Electronic expansion valve (Main)	Y1E	Y1E	PI control	—
Electronic expansion valve (Subcooling)	—	Y3E	PI control	—
Four way valve	Y1S	Y1S	ON	—
Hot gas bypass valve	Y2S	—	OFF	This valve turns ON with low pressure protection control.

* Heating operation is not functional at an outdoor air temperature of 24°CDB (75.2°FDB) or more.

2.2 Compressor PI Control

Carries out compressor capacity PI control to maintain Te at constant during cooling operation and Tc at constant during heating operation, thus ensuring stable unit performance.

Te: Low pressure equivalent saturation temperature

TeS: Target Te value (varies depending on Te setting, operating frequency, etc.)

Tc: High pressure equivalent saturation temperature

TcS: Target Tc value (varies depending on Tc setting, operating frequency, etc.)

Cooling Operation

Controls compressor capacity to achieve target Te value (TeS).

(1) VRT control (Default)

When the required capacity of all indoor units (suction air temperature – set temperature) is small, the target evaporation temperature is further increased in order to adjust capacity. From the outdoor unit side, the temperature difference for all indoor units (ΔT) is confirmed, and the target temperature is changed.

(2) Constant pressure control

The target evaporation temperature is not changed.

Te setting (Make this setting while in setting mode 2-8.)

Lower	Normal	VRT (Default)	Higher			
3°C (37.4°F)	6°C (42.8°F)	Variable	8°C (46.4°F)	9°C (48.2°F)	10°C (50°F)	11°C (51.8°F)

TeS upper limit setting (setting mode 2-11) (for RZR30-48TB, RZQ30-48TB models only)

When the required capacity of all indoor units is small, setting the upper limit of the target temperature to H enables more energy-saving operation.

Note: In high-humidity areas, it is recommended to keep this setting to M or L.

Setting item	Condition		
TeS upper limit setting	L	M (Default)	H

Heating Operation

Controls compressor capacity to achieve target Tc value (TcS).

(1) VRT control (Default)

When the required capacity of all indoor units (set temperature – suction air temperature) is small, the target condensation temperature is further decreased in order to adjust capacity. From the outdoor unit side, the temperature difference for all indoor units (ΔT) is confirmed, and the target temperature is changed.

(2) Constant pressure control

The target condensation temperature is not changed.

Tc setting (Make this setting while in setting mode 2-9.)

VRT (Default)	Normal	Higher
Variable	46°C (114.8°F)	52°C (125.6°F)

TcS lower limit setting (setting mode 2-54) (for RZQ30-48TB models only)

When the required capacity of all indoor units is small, setting the lower limit of the target temperature to L or LL enables more energy-saving operation.

Note: The supply air temperature will become lower than the initial setting. If cold drafts are felt, return the setting to M.

Setting item	Condition			
TcS lower limit setting	LL	L	M (Default)	H

18/24 class

Step	Frequency (Hz)
1	48
2	52.5
3	57
4	61.5
5	67.5
6	75
7	81
8	90
9	100.5
10	105
11	111
12	114
13	118.5
14	129
15	141
16	153
17	163.5
18	174
19	181.5
20	192
21	201
22	211.5
23	222
24	228
25	243
26	253.5
27	265.5
28	277.5
29	289.5
30	301.5

30-48 class

Step	Frequency (Hz)
1	45
2	52.5
3	57
4	61.5
5	66
6	72
7	78
8	85.5
9	96
10	105
11	108
12	112.5
13	115.5
14	121.5
15	128.1
16	145.5
17	154.5
18	163.5
19	178.5
20	196.5
21	216
22	223.5
23	232.5
24	244.5
25	253.5
26	255
27	273
28	288
29	309
30	327

2.3 Electronic Expansion Valve PI Control

Main Electronic Expansion Valve Control

Carries out main electronic expansion valve (Y1E) PI control to maintain the evaporator outlet superheating degree (SH) at constant during heating operation, thus making maximum use of the outdoor heat exchanger (evaporator).

SH = Ts1 – Te SH: Evaporator outlet superheating degree
 Ts1: Suction pipe temperature detected by thermistor R3T
 Te: Low pressure equivalent saturation temperature

The optimum initial value of the evaporator outlet superheating degree is 3°C (5.4°F), but varies depending on the discharge pipe superheating degree of inverter compressor.

Subcooling Electronic Expansion Valve Control

Carries out PI control of subcooling electronic expansion valve (Y3E) to keep the superheating degree (SH) of the outlet gas pipe on the evaporator side for the full use of the subcooling heat exchanger.

SH = Tsh – Te SH: Evaporator outlet superheating degree
 Tsh: Subcooling heat exchanger gas pipe temperature detected by thermistor R6T
 Te: Low pressure equivalent saturation temperature

2.4 Cooling Operation Fan Control

In cooling operation with low outdoor air temperature, this control is used to provide an adequate amount of circulation air with liquid pressure secured by high pressure control from the outdoor fan. Furthermore, when outdoor temperature $\geq 20^{\circ}\text{C}$ (68°F), the compressor will run in Step 7 or higher. When outdoor temperature $\geq 18^{\circ}\text{C}$ (64.4°F), it will run in Step 5 or higher. When outdoor temperature $\geq 12^{\circ}\text{C}$ (53.6°F), it will run in Step 1 or higher.

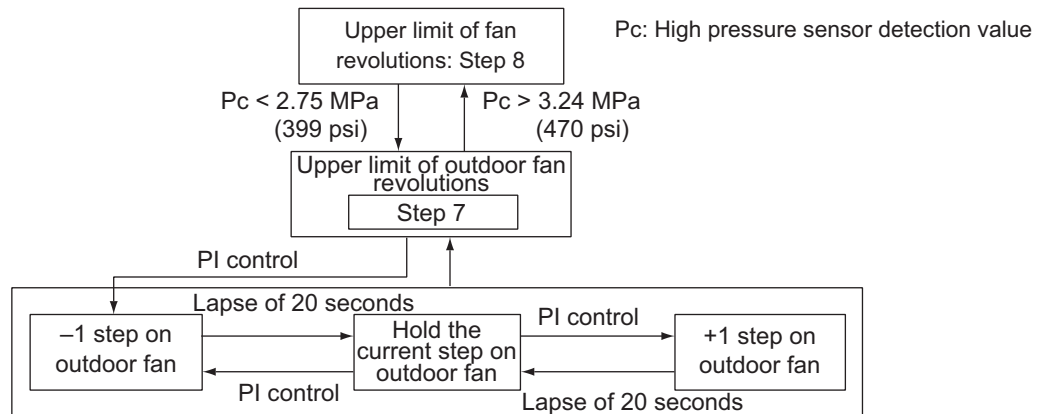

Fan Steps

Step	Fan speed (rpm)		
	18/24 class	30-48 class	
		M1F	M2F
1	200	250	0
2	250	400	0
3	300	285	250
4	480	360	325
5	515	445	410
6	620	580	545
7	830	715	680
8	920	850	815

3. Special Control

3.1 Startup Control

This control is used to equalize the pressure in the suction and discharge sides of the compressor prior to compressor startup, thus reducing startup loads. Furthermore, the inverter is turned ON to charge the capacitor.

In addition, to avoid stresses to the compressor due to oil return, etc., after startup, the following control is made and the position of the four way valve is also determined.

Pc: High pressure sensor detection value

Pe: Low pressure sensor detection value

Ta: Outdoor air temperature

3.1.1 Startup Control in Cooling

Outdoor unit actuator	Electric Symbol		Pressure equalization control prior to startup	Startup control	
	18/24 class	30-48 class		STEP 1	STEP 2
Compressor	M1C	M1C	0 Hz	Minimum frequency	Increases 2 steps every 20 seconds from minimum frequency until $P_c - P_e > 0.39$ MPa (56.6 psi) is achieved
Outdoor fan	M1F	M1F M2F	STEP 7	Ta < 20°C (68°F): OFF Ta ≥ 20°C (68°F): STEP 4	+1 step/15 sec. (when $P_c > 2.16$ MPa (313 psi)) -1 step/15 sec. (when $P_c < 1.77$ MPa (257 psi))
Electronic expansion valve (Main)	Y1E	Y1E	0 pulse	480 pulse (Fully open)	480 pulse (Fully open)
Electronic expansion valve (Subcooling)	—	Y3E	0 pulse	0 pulse	0 pulse
Four way valve	Y1S	Y1S	Holds	OFF	OFF
Hot gas bypass valve	Y2S	—	OFF	OFF	OFF
Ending conditions			OR (<ul style="list-style-type: none"> • $P_c - P_e < 0.3$ MPa (43.5 psi) • A lapse of 1 to 5 min. 	A lapse of 10 sec.	OR (<ul style="list-style-type: none"> • A lapse of 130 sec. • $P_c - P_e > 0.39$ MPa (56.6 psi)

3.1.2 Startup Control in Heating

Outdoor unit actuator	Electric Symbol		Pressure equalization control prior to startup	Startup control	
	18/24 class	30-48 class		STEP 1	STEP 2
Compressor	M1C	M1C	0 Hz	Minimum frequency	Increases 2 steps every 20 seconds from minimum frequency until $P_c - P_e > 0.39 \text{ MPa}$ (56.6 psi) is achieved
Outdoor fan	M1F	M1F M2F	From starting $T_a > 20^\circ\text{C}$ (68°F): STEP 1 $T_a \leq 20^\circ\text{C}$ (68°F): OFF	STEP 8	STEP 8
Electronic expansion valve (Main)	Y1E	Y1E	0 pulse	0 pulse	0 pulse
Electronic expansion valve (Subcooling)	—	Y3E	0 pulse	0 pulse	0 pulse
Four way valve	Y1S	Y1S	Holds	ON	ON
Hot gas bypass valve	Y2S	—	OFF	OFF	OFF
Ending conditions			OR (<ul style="list-style-type: none"> • $P_c - P_e < 0.3 \text{ MPa}$ (43.5 psi) • A lapse of 1 to 5 min. 	A lapse of 10 sec.	OR (<ul style="list-style-type: none"> • A lapse of 130 sec. • $P_c > 2.70 \text{ MPa}$ (392 psi) • $P_c - P_e > 0.39 \text{ MPa}$ (56.6 psi)

3.2 Oil Return Control

In order to prevent the compressor from running out of oil, oil return control is conducted to recover oil that has flowed out from the compressor to the system side.

HTdi: Compressor discharge pipe temperature (Tdi) compensated with outdoor air temperature

Pe: Low pressure sensor detection value

Tc: High pressure equivalent saturation temperature

Te: Low pressure equivalent saturation temperature

Ts1: Suction pipe temperature detected by thermistor R3T

3.2.1 Oil Return Control in Cooling

Starting Conditions

- Oil return operation is not conducted before 2 hours have elapsed from the activation of power supply.
- After 2 hours have elapsed, oil return operation starts when the following item meets the reference value.
 - ◆ Total amount of oil discharged from the compressor (The total amount of oil discharged from the compressor is computed from Tc, Te, and compressor loads.)
- Oil return operation starts every 8 hours of cumulative operation of the compressor, even if the reference value is not met.

Outdoor unit actuator	Electric Symbol		Oil return preparation control	Oil return control	Control after oil return
	18/24 class	30-48 class			
Compressor	M1C	M1C	Take the current step as the upper limit.	Minimum frequency (→ Low pressure protection control)	Same as oil return control.
Outdoor fan	M1F	M1F M2F	Fan control (Normal cooling)	Fan control (Normal cooling)	Fan control (Normal cooling)
Electronic expansion valve (Main)	Y1E	Y1E	480 pulse (Fully open)	480 pulse (Fully open)	480 pulse (Fully open)
Electronic expansion valve (Subcooling)	—	Y3E	SH control	0 pulse	0 pulse
Four way valve	Y1S	Y1S	OFF	OFF	OFF
Hot gas bypass valve	Y2S	—	OFF	OFF	OFF
Ending conditions			20 seconds	OR (<ul style="list-style-type: none"> • 3 minutes • $Ts1 - Te < 5^{\circ}\text{C}$ (9°F) 	OR (<ul style="list-style-type: none"> • 3 minutes • $Pe < 0.6 \text{ MPa}$ (87 psi) • $HTdi > 110^{\circ}\text{C}$ (230°F)

	Indoor unit actuator	Cooling oil return control
Fan	Thermostat ON unit	Remote controller setting
	Non-operating unit	OFF
	Thermostat OFF unit	Remote controller setting
Electronic expansion valve	Thermostat ON unit	Normal opening
	Non-operating unit	224 pulse
	Thermostat OFF unit	Normal opening with forced thermostat ON

3.2.2 Oil Return Control in Heating

Pc: High pressure sensor detection value
 Pe: Low pressure sensor detection value
 Tc: High pressure equivalent saturation temperature
 Te: Low pressure equivalent saturation temperature
 Ts1: Suction pipe temperature detected by thermistor R3T
 Tb: Heat exchanger temperature

Starting Conditions

- Oil return operation is not conducted before 2 hours have elapsed from the activation of power supply.
- After 2 hours have elapsed, oil return operation starts when the following item meets the reference value.
 - ◆ Total amount of oil discharged from the compressor (The total amount of oil discharged from the compressor is computed from Tc, Te, and compressor loads.)
- Oil return operation starts every 8 hours of cumulative operation of the compressor, even if the reference value is not met.

Outdoor unit actuator	Electric Symbol		(A) Oil return preparation control	(B) Oil return control	(C) Control after oil return
	18/24 class	30-48 class			
Compressor	M1C	M1C	Upper limit control	140 Hz Full load	Increases 2 steps every 20 seconds from minimum frequency until $P_c - P_e > 0.4 \text{ MPa}$ (58 psi) is achieved.
Outdoor fan	M1F	M1F M2F	STEP 8	OFF	STEP 8
Electronic expansion valve (Main)	Y1E	Y1E	SH control	480 pulse (Fully open)	55 pulse
Electronic expansion valve (Subcooling)	—	Y3E	0 pulse	0 pulse	0 pulse
Four way valve	Y1S	Y1S	ON	OFF	ON
Hot gas bypass valve	Y2S	—	OFF	OFF	OFF
Ending conditions			2 minutes	OR $\left(\begin{array}{l} \bullet 12 \text{ minutes} \\ \bullet Ts1 - Te < 5^\circ\text{C} (9^\circ\text{F}) \\ \bullet Tb > 11^\circ\text{C} (51.8^\circ\text{F}) \end{array} \right)$	OR $\left(\begin{array}{l} \bullet 160 \text{ seconds} \\ \bullet P_c - P_e > 0.4 \text{ MPa} (58 \text{ psi}) \end{array} \right)$

* Between (A) oil return preparation control and (B) oil return control, and between (B) oil return control and (C) control after oil return, the compressor stops for 1 minute to reduce noise on changing of the four way valve.

Indoor unit actuator		Heating oil return control
Fan	Thermostat ON unit	OFF
	Non-operating unit	OFF
	Thermostat OFF unit	OFF
Electronic expansion valve	Thermostat ON unit	416 pulse
	Non-operating unit	256 pulse
	Thermostat OFF unit	416 pulse

3.3 Defrost Control

Pc: High pressure sensor detection value

Pe: Low pressure sensor detection value

Tb: Heat exchanger deicer temperature

Tc: High pressure equivalent saturation temperature

Te: Low pressure equivalent saturation temperature

Ts1: Suction pipe temperature detected by thermistor R3T

Defrost control is performed to melt frost on the outdoor heat exchanger when heating, and thus recover heating capacity.

Starting Conditions

- Defrost operation is not conducted before 40 minutes have elapsed from the start of heating operation.
- After 40 minutes have elapsed, defrost operation starts when the following items meet the reference values.
 - ◆ Heat transfer coefficient of the outdoor heat exchanger (The heat transfer coefficient of the outdoor heat exchanger is computed from Tc, Te, and compressor loads.)
 - ◆ Outdoor heat exchanger deicer temperature (Tb)
- Defrost operation starts every 2 hours, even if the reference values are not met.

Outdoor unit actuator	Electric Symbol		(A) Defrost preparation control	(B) Defrost control	(C) Control after defrost
	18/24 class	30-48 class			
Compressor	M1C	M1C	Upper limit control	140 Hz Full load	Increases 2 steps every 20 seconds from minimum frequency until Pc – Pe > 0.4 MPa (58 psi) is achieved.
Outdoor fan	M1F	M1F M2F	STEP 8	OFF	STEP 8
Electronic expansion valve (Main)	Y1E	Y1E	SH control	480 pulse (Fully open)	55 pulse
Electronic expansion valve (Subcooling)	—	Y3E	0 pulse	0 pulse	0 pulse
Four way valve	Y1S	Y1S	ON	OFF	ON
Hot gas bypass valve	Y2S	—	OFF	ON	ON
Ending conditions			2 minutes	OR (<ul style="list-style-type: none"> • 12 minutes • Tb > 11°C (51.8°F) • Ts1 – Te < 5°C (9°F))	OR (<ul style="list-style-type: none"> • 160 seconds • Pc – Pe > 0.4 MPa (58 psi))

* Between (A) defrost preparation control and (B) defrost control, and between (B) defrost control and (C) control after defrost, the compressor stops for 1 minute to reduce noise on changing of the four way valve.

Indoor unit actuator		Defrost control
Fan	Thermostat ON unit	OFF
	Non-operating unit	OFF
	Thermostat OFF unit	OFF
Electronic expansion valve	Thermostat ON unit	416 pulse
	Non-operating unit	256 pulse
	Thermostat OFF unit	416 pulse

3.4 Pump Down Residual Control

If liquid refrigerant is retained in the evaporator when the compressor is activated, the liquid refrigerant enters the compressor and dilutes oil therein resulting in a decrease of lubricity. Therefore, pump down residual control is performed to collect the refrigerant retained in the evaporator when the compressor stops.

3.4.1 Pump Down Residual Control in Cooling

Outdoor unit actuator	Electric Symbol		Pump down residual control	
	18/24 class	30-48 class	Step 1	Step 2
Compressor	M1C	M1C	124 Hz	Minimum frequency
Outdoor fan	M1F	M1F M2F	Fan control	Fan control
Electronic expansion valve (Main)	Y1E	Y1E	480 pulse (Fully open)	240 pulse (Half open)
Electronic expansion valve (Subcooling)	—	Y3E	0 pulse	0 pulse
Four way valve	Y1S	Y1S	OFF	OFF
Hot gas bypass valve	Y2S	—	OFF	OFF
Ending conditions			2 seconds	2 seconds

3.4.2 Pump Down Residual Control in Heating

Outdoor unit actuator	Electric Symbol		Pump down residual control
	18/24 class	30-48 class	
Compressor	M1C	M1C	124 Hz
Outdoor fan	M1F	M1F M2F	STEP 7
Electronic expansion valve (Main)	Y1E	Y1E	0 pulse
Electronic expansion valve (Subcooling)	—	Y3E	0 pulse
Four way valve	Y1S	Y1S	ON
Hot gas bypass valve	Y2S	—	OFF
Ending conditions			4 seconds

3.5 Restart Standby

Restart is forced into standby to prevent the power from frequently turning on and off and to equalize pressure in the refrigerant system.

Ta: Outdoor air temperature

Outdoor unit actuator	Electric Symbol		Operation
	18/24 class	30-48 class	
Compressor	M1C	M1C	OFF
Outdoor fan	M1F	M1F M2F	Ta > 30°C (86°F): STEP 4 Ta ≤ 30°C (86°F): OFF
Electronic expansion valve (Main)	Y1E	Y1E	0 pulse
Electronic expansion valve (Subcooling)	—	Y3E	0 pulse
Four way valve	Y1S	Y1S	Holds
Hot gas bypass valve	Y2S	—	OFF
Ending conditions			2 minutes

3.6 Stop Control

Actuator operation is cleared when the system is down.

Outdoor unit actuator	Electric Symbol		Operation
	18/24 class	30-48 class	
Compressor	M1C	M1C	OFF
Outdoor fan	M1F	M1F M2F	OFF
Electronic expansion valve (Main)	Y1E	Y1E	0 pulse
Electronic expansion valve (Subcooling)	—	Y3E	0 pulse
Four way valve	Y1S	Y1S	Holds
Hot gas bypass valve	Y2S	—	OFF
Ending conditions			Indoor unit thermostat is turned ON.

4. Protection Control

4.1 High Pressure Protection Control

This high pressure protection control is used to prevent the activation of protection devices due to an abnormal increase of high pressure and to protect compressors against the transient increase of high pressure.

Pc: High pressure sensor detection value

Cooling Operation

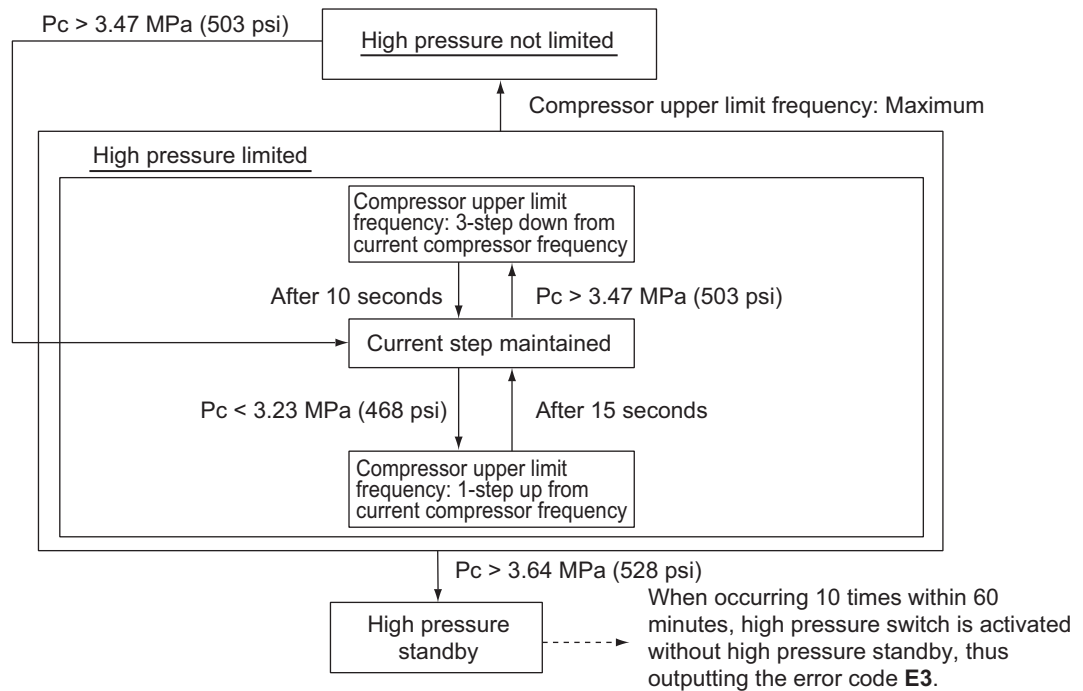

Heating Operation

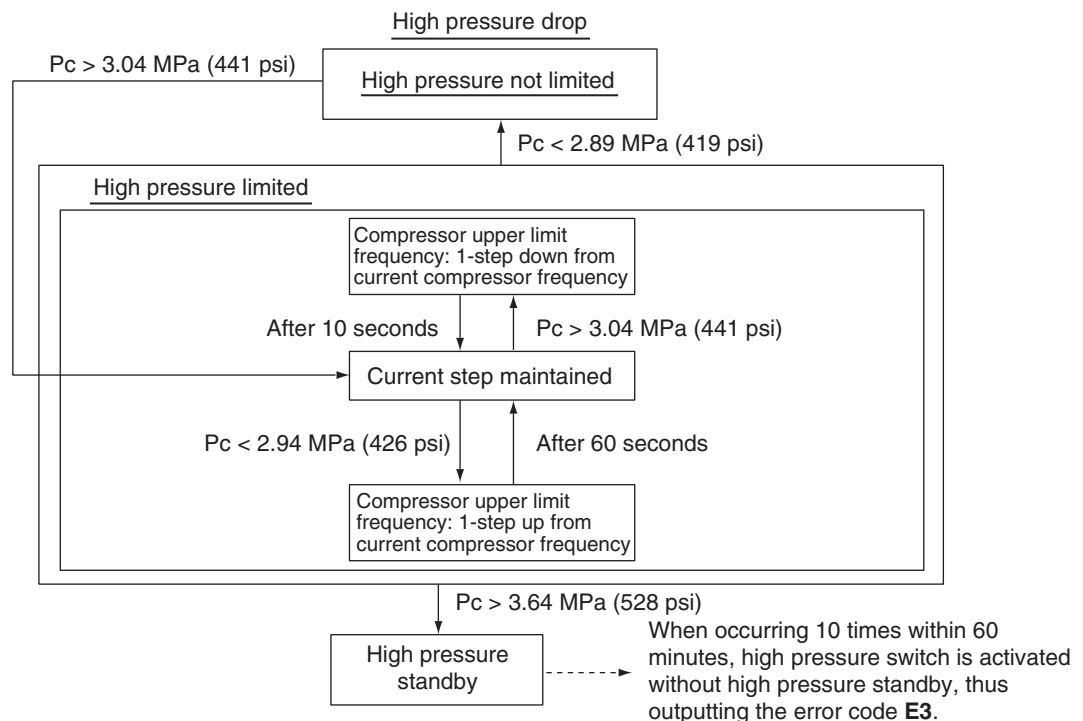

4.2 Low Pressure Protection Control

This low pressure protection control is used to protect compressors against the transient decrease of low pressure.

Pe: Low pressure sensor detection value

Cooling Operation

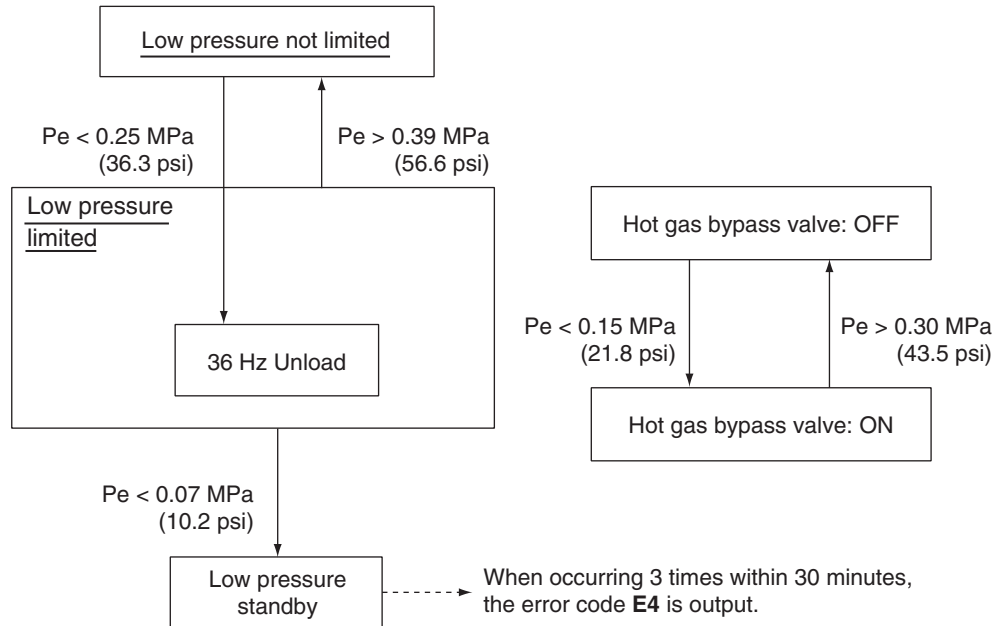

Heating Operation

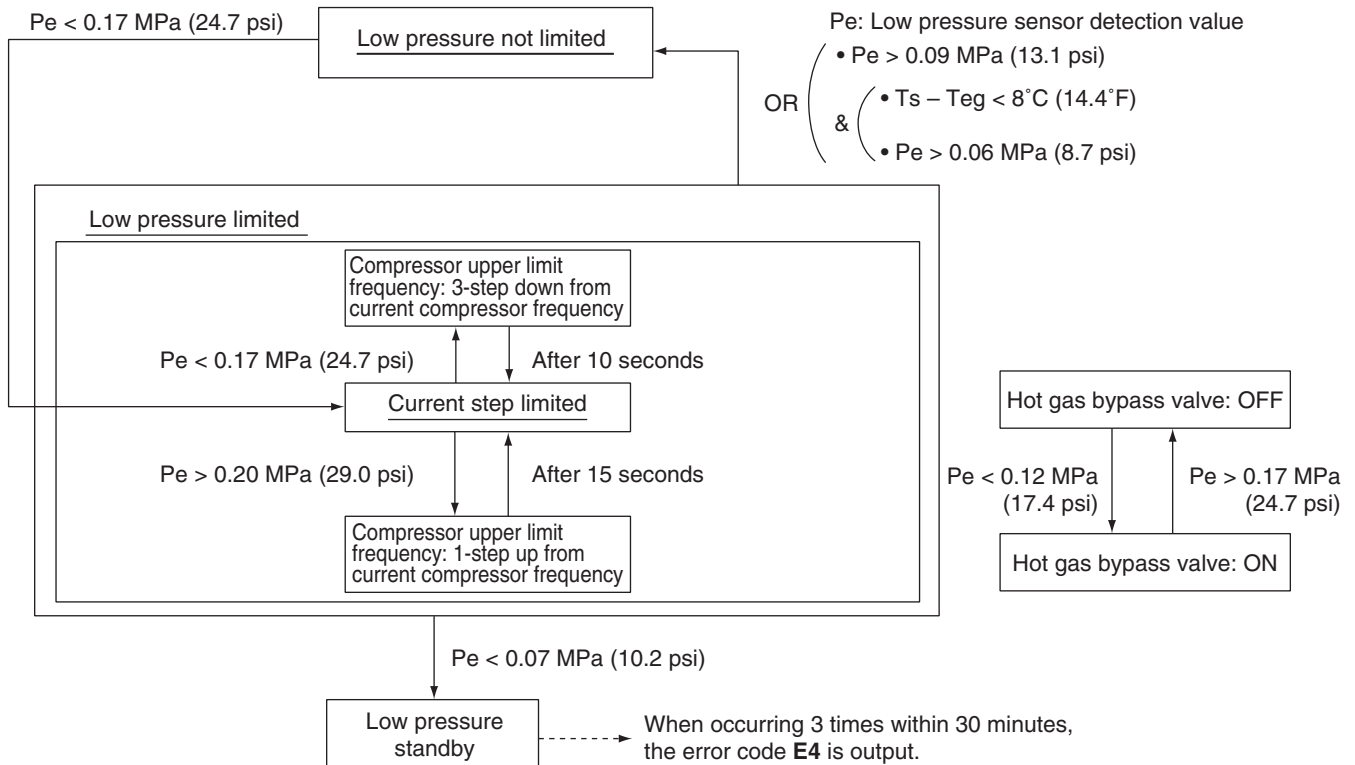

4.3 Discharge Pipe Temperature Protection Control

This discharge pipe temperature protection control is used to protect the compressor internal temperature against an error or transient increase of discharge pipe temperature.

HTdi: Value of inverter compressor discharge pipe temperature (Tdi) compensated with outdoor air temperature

Tp: Value of compressor port temperature calculated by Tc, Te, and suction superheating degree.

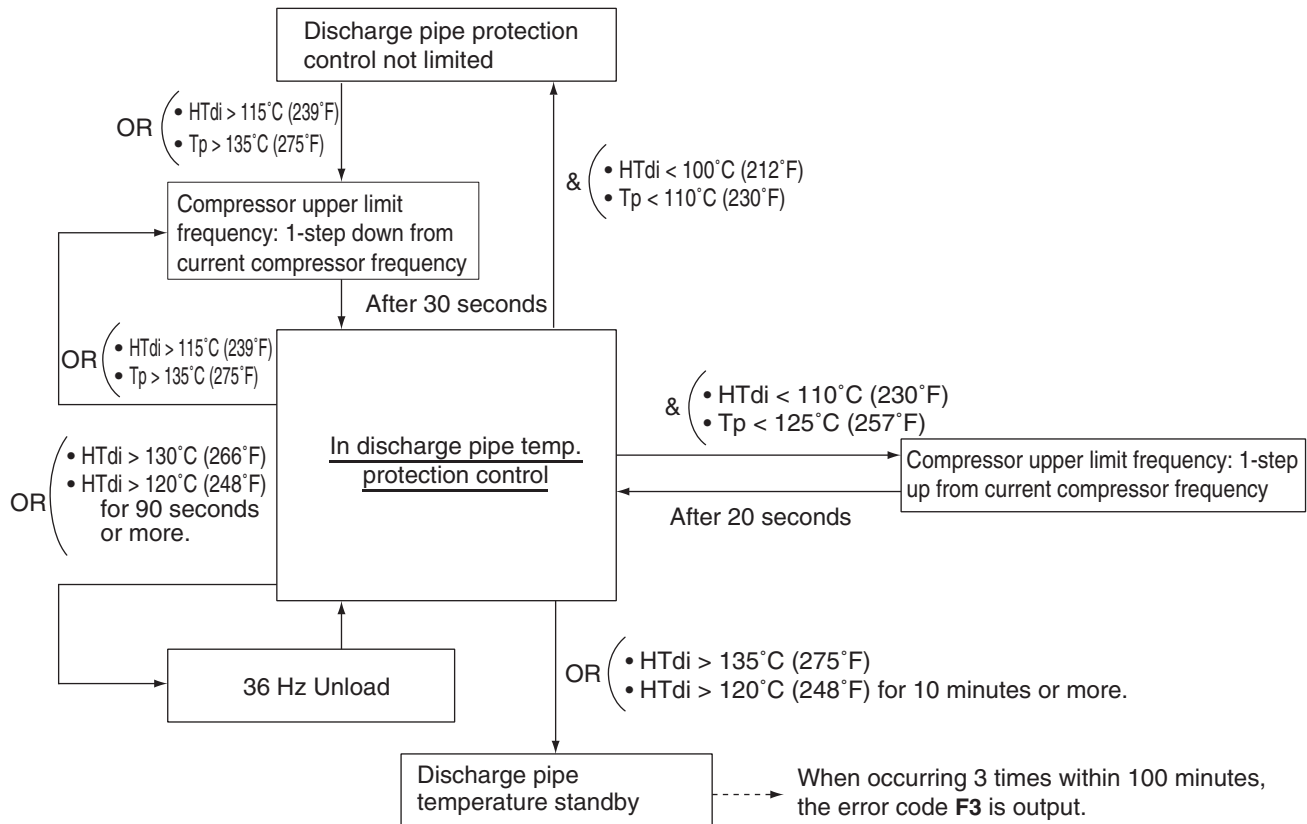

4.4 Inverter Protection Control

Inverter current protection control and radiation fin temperature control are performed to prevent tripping due to an error, or transient inverter overcurrent, and radiation fin temperature increase.
 T_{fin}: Radiation fin temperature

Inverter overcurrent protection control

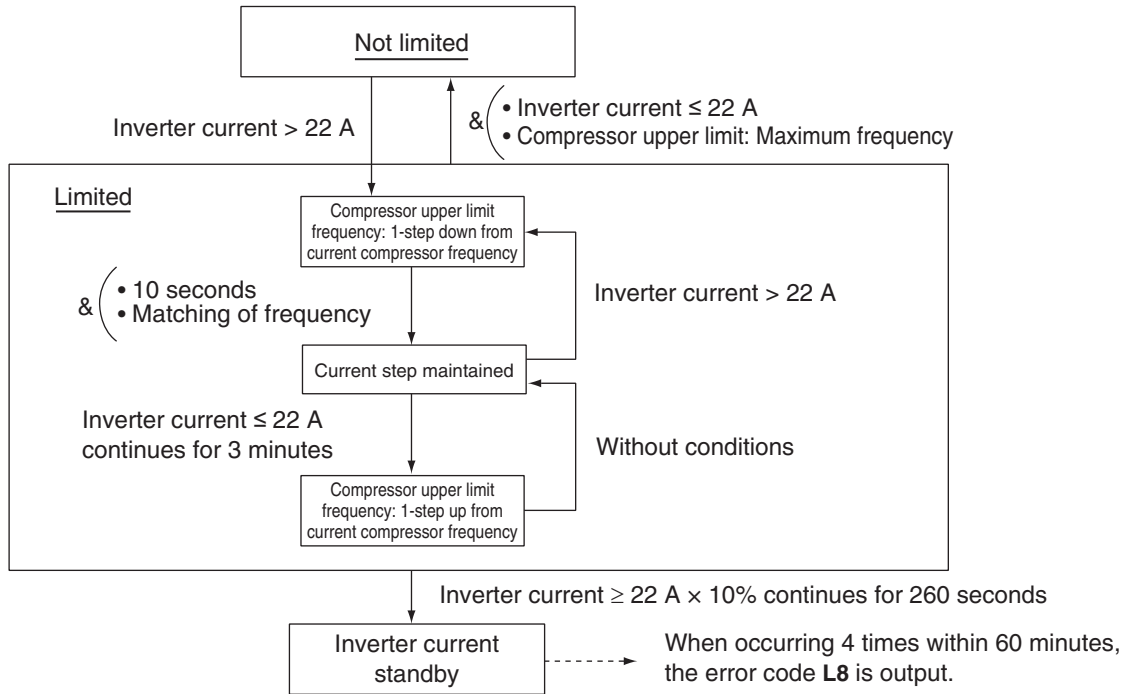

Radiation fin temperature control

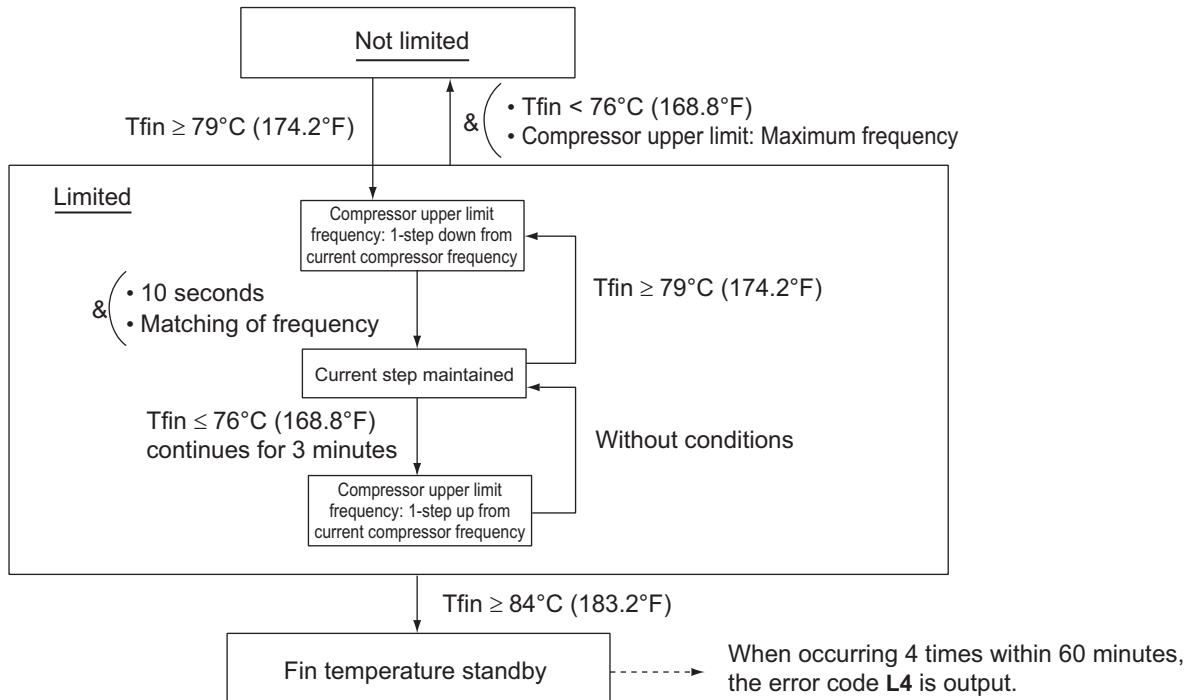

According to the current limit of direct current

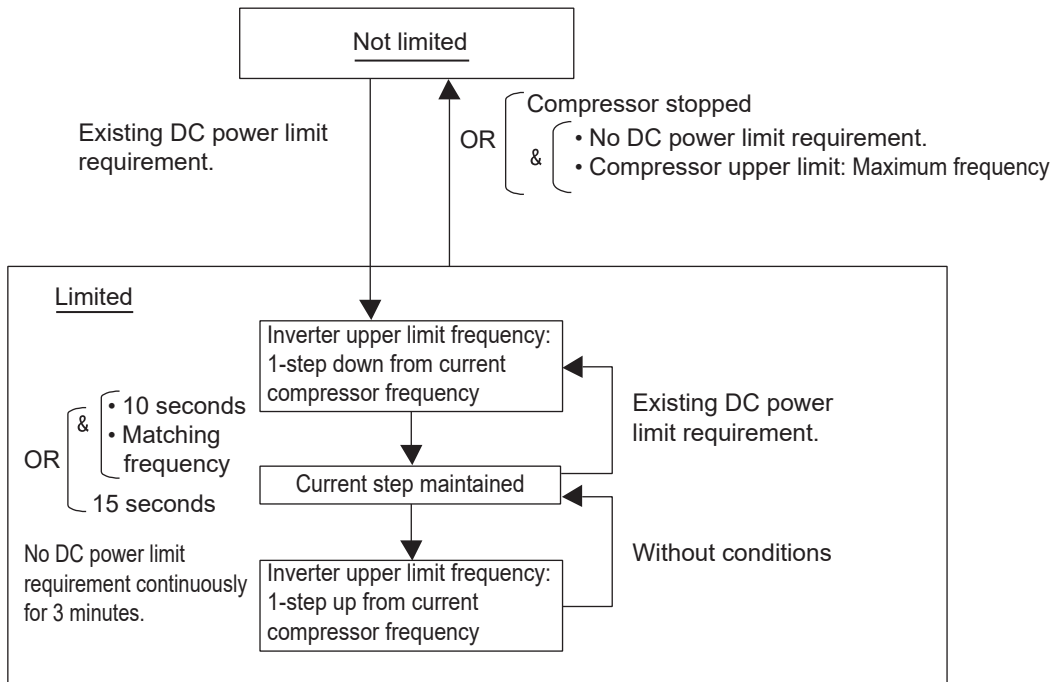

5. Other Control

5.1 Demand Operation

In order to reduce power consumption, the outdoor unit capacity is reduced forcibly with control by using Demand Setting 1.

To enable this operation, the additional setting of Constant Demand Setting is required.

Demand setting 1

Level	Standard for upper limit of power consumption
Level 1	Approx. 60%
Level 2 (Factory setting)	Approx. 70%
Level 3	Approx. 80%

* Other protection control functions have precedence over the above operation.

5.2 Heating Operation Prohibition

Heating operation is prohibited above 24°CDB (75.2°FDB) outdoor air temperature.

6. Outline of Control (Indoor Unit)

6.1 Remote Controller Thermistor

Temperature is controlled by both the remote controller thermistor and suction air thermistor (*1) for the indoor unit. (This is however limited to when the field setting for the remote controller thermistor is set to Use.)



Note(s)

When fresh air intake kit is used, outdoor air is mixed with indoor air, and the room temperature may not reach the set temperature, since TS and TH1 do not enter the area in which remote controller thermistor can be used. In such case, install the remote sensor (optional accessory) in your room, and set the field settings to not use the remote controller thermistor.

* FTQ-TA models do not have this control because they do not have suction air thermistor. The thermistor is selectable manually when remote sensor (optional accessory) is installed.

Cooling

If there is a significant difference in the set temperature and the suction temperature, fine adjustment control is carried out using a suction air thermistor (*1), or using the remote controller thermistor near the position of the user when the suction temperature is near the set temperature.

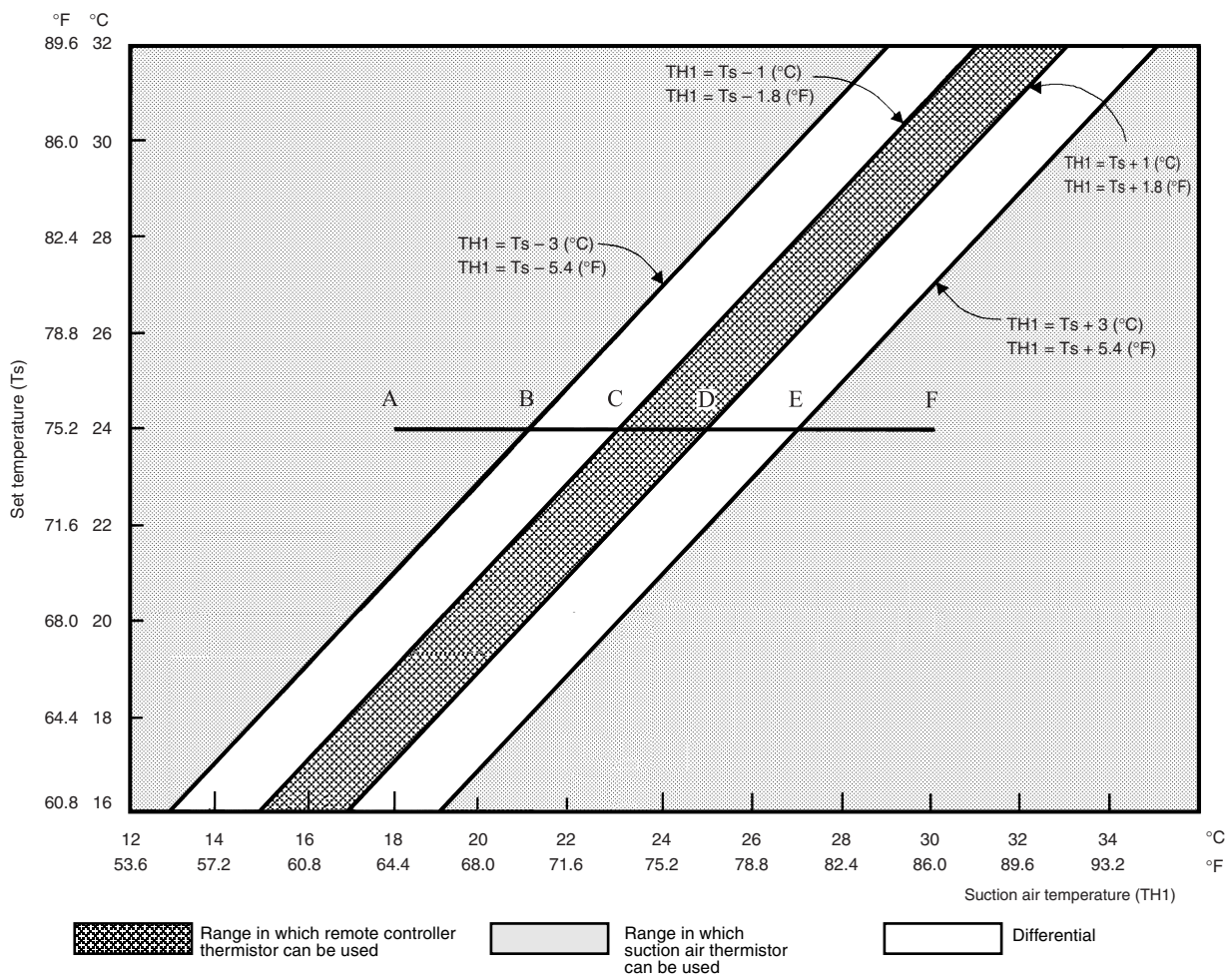

■ **Assuming the set temperature in the figure above is 24°C (75°F), and the suction temperature has changed from 18°C (64°F) to 30°C (86°F) (A → F):**

(This example also assumes there are several other air conditioners, and the suction temperature changes even when the thermostat is off.)

Suction air thermistor (*1) is used for temperatures from 18°C (64°F) to 23°C (73°F) (A → C).

Remote controller thermistor is used for temperatures from 23°C (73°F) to 27°C (81°F) (C → E).

Suction air thermistor (*1) is used for temperatures from 27°C (81°F) to 30°C (86°F) (E → F).

- **Assuming suction temperature has changed from 30°C (86°F) to 18°C (64°F) (F → A):**
 Suction air thermistor (*1) is used for temperatures from 30°C (86°F) to 25°C (77°F) (F → D).
 Remote controller thermistor is used for temperatures from 25°C (77°F) to 21°C (70°F) (D → B).
 Suction air thermistor (*1) is used for temperatures from 21°C (70°F) to 18°C (64°F) (B → A).



Note(s)

*1. For FTQ: Remote sensor (Optional accessory)

Heating

When heating, the hot air rises to the top of the room, resulting in the temperature being lower near the floor where the occupants are. When controlling by suction air thermistor (*1) only, the indoor unit may therefore be turned off by the thermostat before the lower part of the room reaches the set temperature. The temperature can be controlled so the lower part of the room where the occupants are does not become cold by widening the range in which remote controller thermistor can be used so that suction temperature is higher than the set temperature.

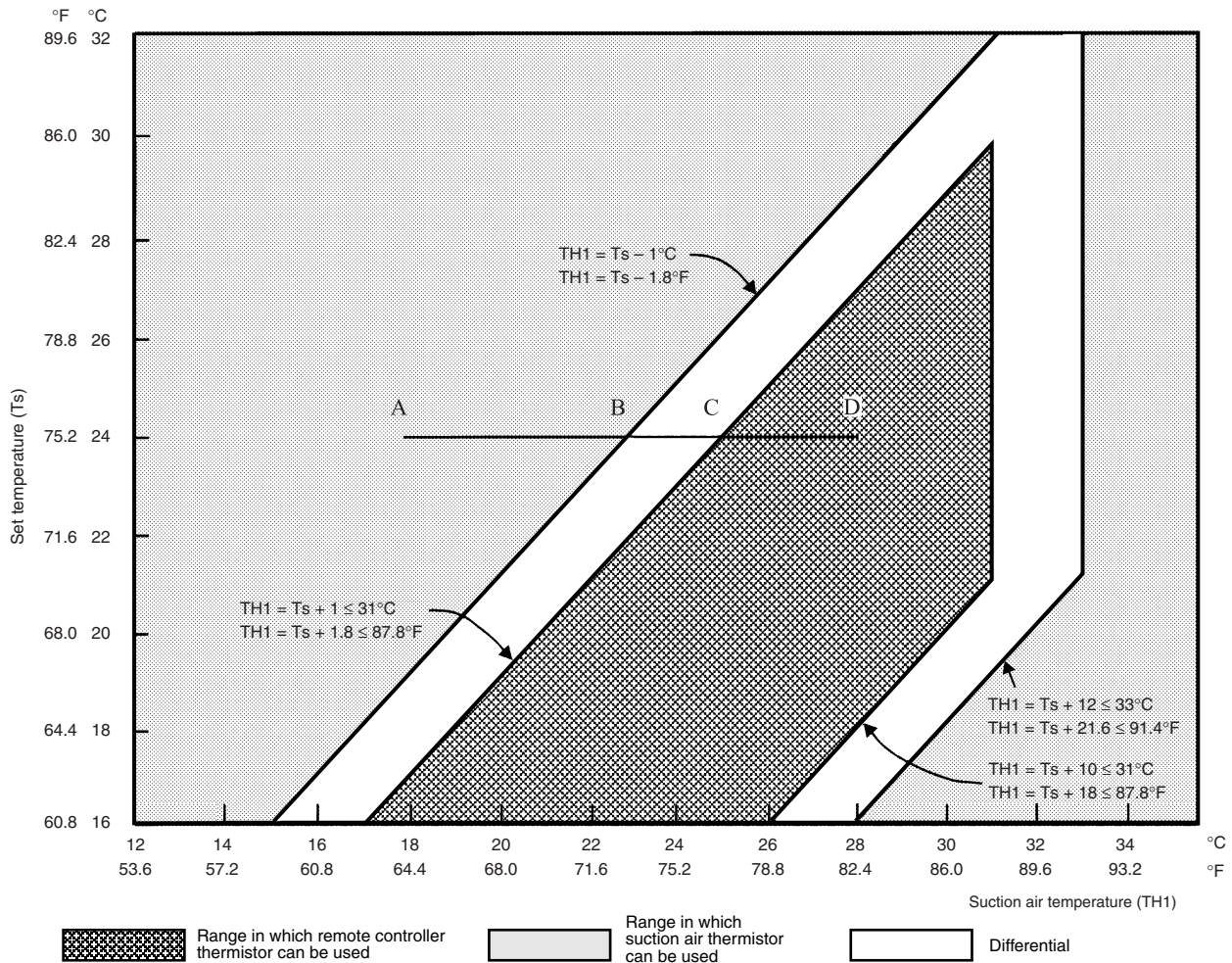

- **Assuming the set temperature in the figure above is 24°C (75°F), and the suction temperature has changed from 18°C (64°F) to 28°C (82°F) (A → D):**
 (This example also assumes there are several other air conditioners, and the suction temperature changes even when the thermostat sensor is off.)
 Suction air thermistor (*1) is used for temperatures from 18°C (64°F) to 25°C (77°F) (A → C).
 Remote controller thermistor is used for temperatures from 25°C (77°F) to 28°C (82°F) (C → D).

- **Assuming suction temperature has changed from 28°C (82°F) to 18°C (64°F) (D → A):**
 Remote controller thermistor is used for temperatures from 28°C (82°F) to 23°C (73°F) (D → B).
 Suction air thermistor (*1) is used for temperatures from 23°C (73°F) to 18°C (64°F) (B → A).



Note(s) *1. For FTQ: Remote sensor (Optional accessory)

6.2 Thermostat Control

The thermostat ON/OFF differential value (factory setting) differs depending on the models.

Differential value	Model
1.0°C (1.8°F)	FCQ-TA, FHQ-P, FHQ-M, FTQ-TA
0.5°C (0.9°F)	FCQ-AA, FAQ-TA, FBQ-P, FBQ-TB

6.2.1 Without Infrared Floor Sensor

Whether the thermostat is turned ON or OFF is determined by the difference between the remote controller set temperature and the actual detected room temperature (*1).

• Normal operation

· Cooling operation

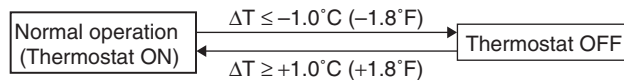

· Heating operation

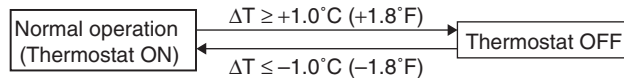

• Dry operation

· When $T_{ro} < 24.5^{\circ}\text{C} (76.1^{\circ}\text{F})$

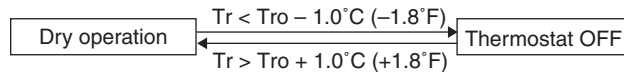

· When $T_{ro} \geq 24.5^{\circ}\text{C} (76.1^{\circ}\text{F})$

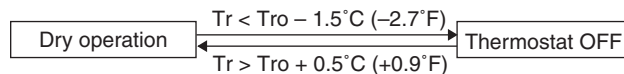

FCQ-AA, FBQ-TB, FTQ-TA only

If the field setting 11 (21)-12 (for FCQ-AA, FBQ-TB), or 14 (24)-5 (for FTQ-TA) is set to **02**, T_{ro} will be the same as the cooling set temperature.

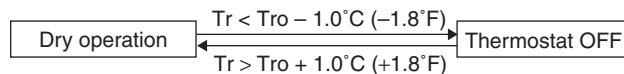

ΔT = Detected room temperature – Remote controller set temperature

T_{ro} : Detected room temperature at the start of dry operation

Tr : Determined by the room temperature detected by the thermistor

*1: The thermistor for room temperature detection depends on the field setting 10 (20)-2.

6.2.2 With Infrared Floor Sensor

Whether the thermostat is turned ON or OFF is determined by the difference between the remote controller set temperature and the detected temperature around people.

• Normal operation

· Cooling operation

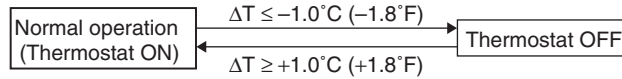

· Heating operation

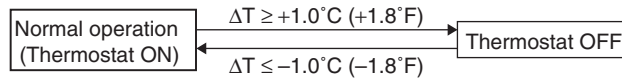

• Dry operation

· When $T_{ro} \leq 24.5^\circ\text{C}$ (76.1°F)

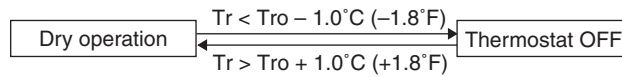

· When $T_{ro} > 24.5^\circ\text{C}$ (76.1°F)

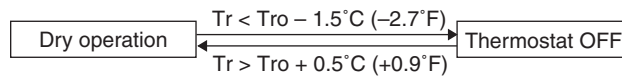

FCQ-AA only

If the field setting 11 (21)-12 is set to **02**, T_{ro} will be the same as the cooling set temperature.

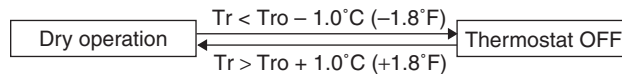

*: Description of symbols

ΔT = Room temperature or temperature around people – Remote controller set temperature

T_{ro} : Room temperature or temperature around people at the start of dry operation

T_r : Room temperature or temperature around people

Control range of temperature around people

When the floor temperature is very low, operation using the temperature around people may cause the suction air temperature to operate outside of use range.

To avoid the above condition, a limit based on the suction air temperature is set for the use range of the temperature around people.

■ Cooling operation

- When the floor temperature is lower than suction air temperature (R1T), R1T will be treated as the control target temperature for operation.
- When the temperature around people is 15°C (59°F) or lower, R1T will be treated as the control temperature for operation.

■ Heating operation

- When the floor temperature is higher than suction air temperature (R1T), R1T will be treated as the control target temperature in operation.
- When the temperature around people is 33°C (91.4°F) or higher, R1T will be treated as the control temperature for operation.

6.3 Thermostat Control with Operation Mode Set to AUTO

The system will conduct this temperature control shown below, only when the wireless remote controller or any central remote controller is connected.

Furthermore, setting changes of the differential value (D) can be made.

★: Factory setting

Mode No.	First code No.	Contents of setting	Second code No.							
			01★	02	03	04	05	06	07	08
12 (22)	4	Differential value while in AUTO operation mode	0°C 0°F ★	1°C 1.8°F	2°C 3.6°F	3°C 5.4°F	4°C 7.2°F	5°C 9.0°F	6°C 10.8°F	7°C 12.6°F

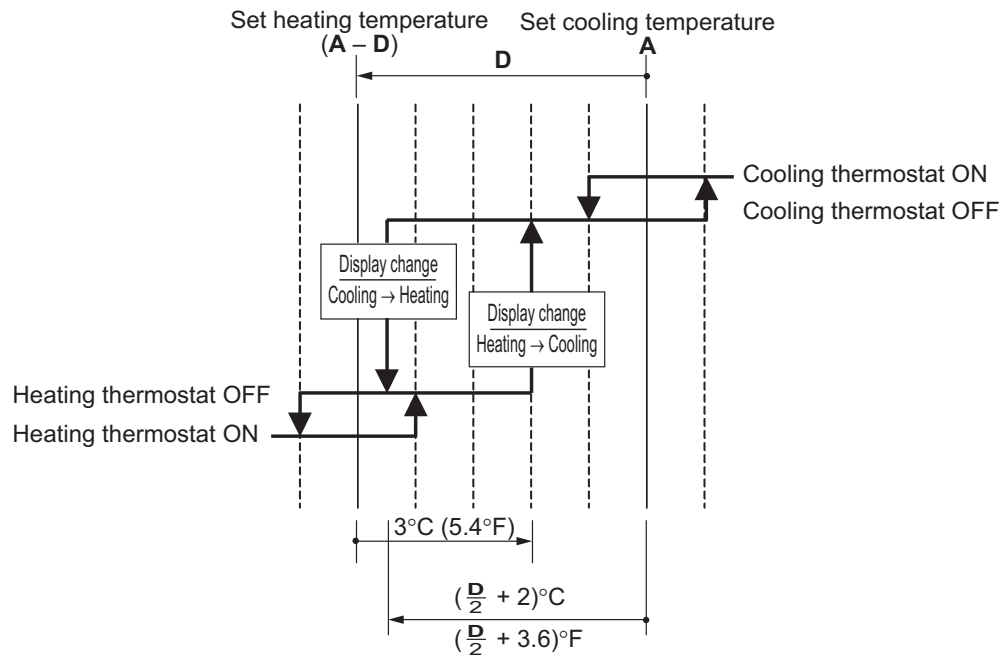

(Ex.) When automatic cooling temperature is set to 27°C (80.6°F):

Differential value: 0°C (0°F)

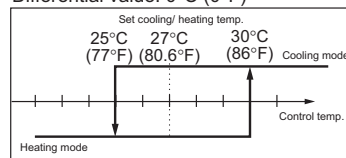

Differential value set to 4°C (7.2°F)

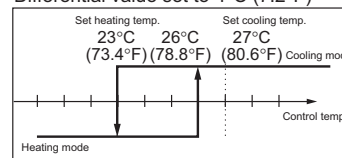

Differential value set to 1°C (1.8°F)

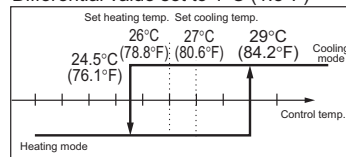

Differential value set to 5°C (9°F)

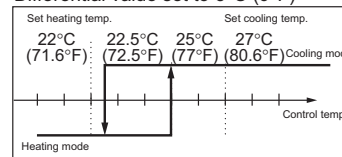

Differential value set to 2°C (3.6°F)

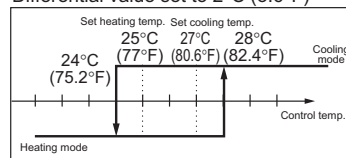

Differential value set to 6°C (10.8°F)

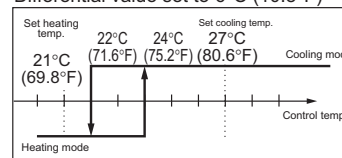

Differential value set to 3°C (5.4°F)

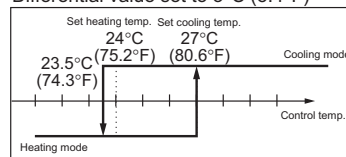

Differential value set to 7°C (12.6°F)

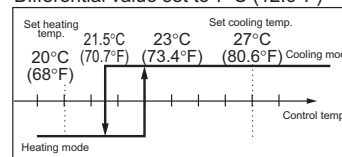

6.4 List of Swing Flap Operations

Swing flaps operate as shown in table below.

Operation mode			Fan	Flap		
				FCQ	FHQ	FAQ
Heating	Hot start from defrost operation	Swing	OFF	Horizontal	Horizontal	Horizontal
		Airflow direction set	OFF	Horizontal	Horizontal	Horizontal
	Defrost operation	Swing	OFF	Horizontal	Horizontal	Horizontal
		Airflow direction set	OFF	Horizontal	Horizontal	Horizontal
	Thermostat OFF	Swing	LL	Horizontal	Horizontal	Horizontal
		Airflow direction set	LL	Horizontal	Horizontal	Horizontal
	Hot start from thermostat OFF mode (for prevention of cold air)	Swing	LL	Horizontal	Horizontal	Horizontal
		Airflow direction set	LL	Horizontal	Horizontal	Horizontal
	Stop	Swing	OFF	Horizontal	Horizontal	Totally closed
		Airflow direction set	OFF	Horizontal	Horizontal	Totally closed
Cooling	Thermostat ON in program dry	Swing	L (*1)	Swing	Swing	Swing
		Airflow direction set	L (*1)	Set	Set	Set
	Thermostat OFF in program dry	Swing	OFF or L	Swing	Swing	Swing
		Airflow direction set		Set	Set	Set
	Thermostat OFF in cooling	Swing	Set	Swing	Swing	Swing
		Airflow direction set	Set	Set	Set	Set
	Stop	Swing	OFF	Horizontal	Horizontal	Totally closed
		Airflow direction set	OFF	Set	Horizontal	Totally closed
	Microcomputer control (including cooling operation)	Swing	L	Swing	Swing	Swing
		Airflow direction set	L	Set	Set	Set



Note(s) *1. L or LL only on FCQ models

6.5 Hot Start Control (In Heating Operation Only)

At startup with thermostat ON or after the completion of defrosting in heating operation, the indoor fan is controlled to prevent cold air from blasting out and ensure startup capacity.

TH2 : Temperature detected with the gas thermistor

Tc : High pressure equivalent saturated temperature

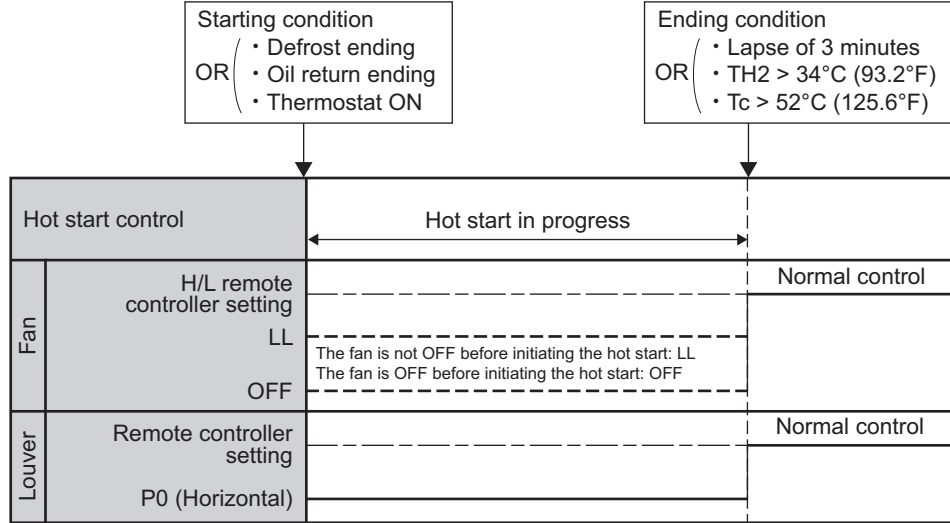

■ FTQ-TA (when the heater is to be used)

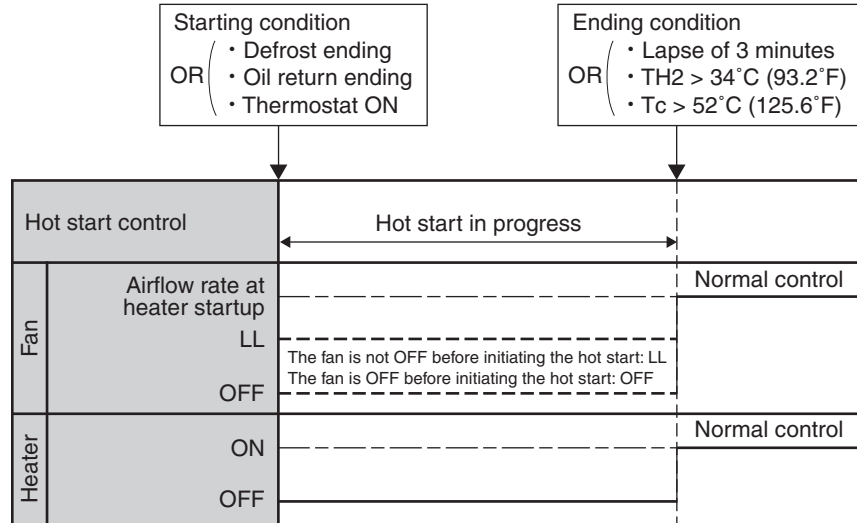

6.6 Louver Control for Preventing Ceiling Dirt (FCQ Models Only)

We have added a control feature that allows you to select the range of in which air direction can be adjusted in order to prevent the ceiling surrounding the air discharge outlet of ceiling mounted cassette type units from being soiled.

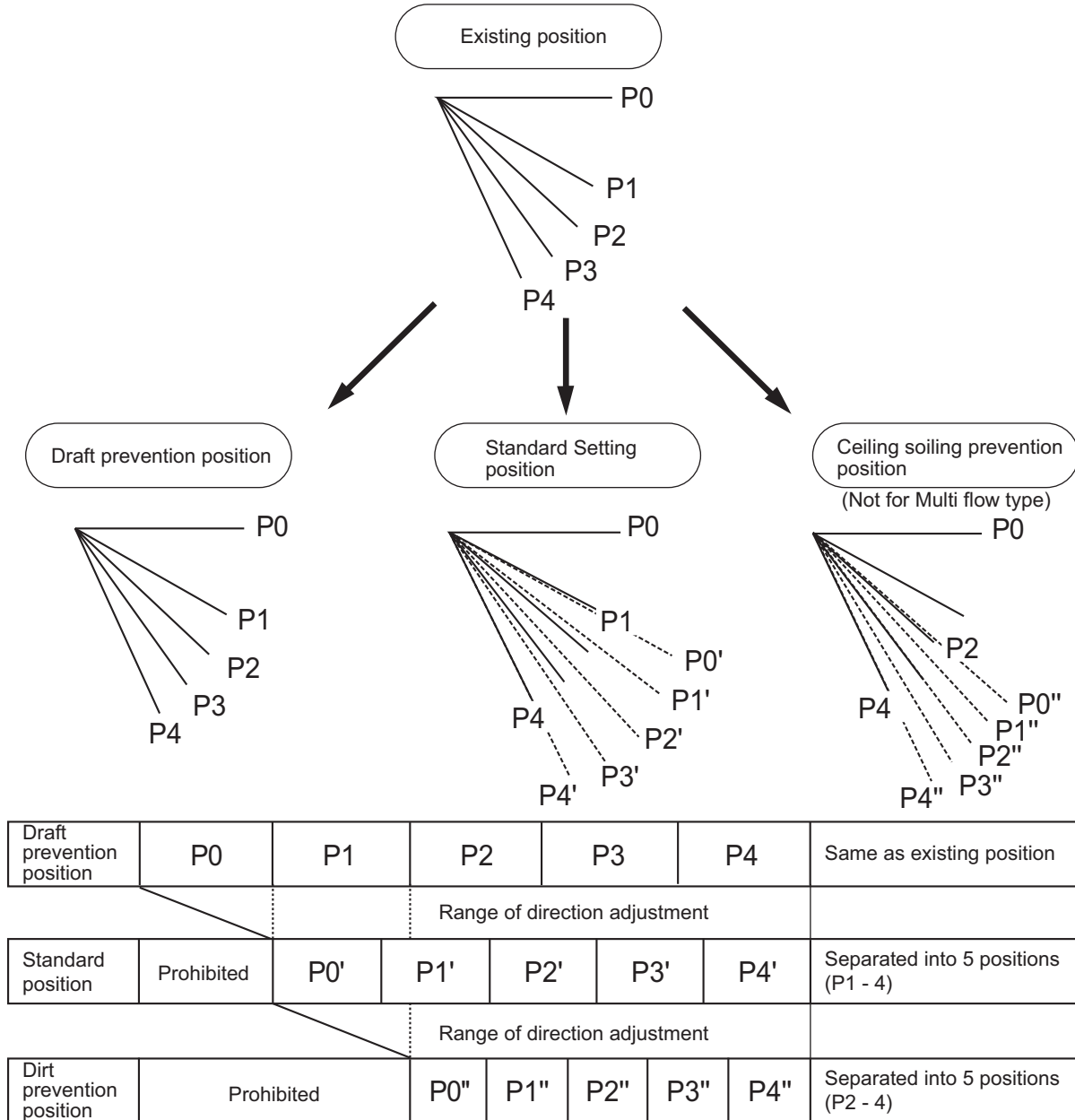

The factory setting position is draft prevention position.

6.7 Drain Pump Control

6.7.1 Normal Operation

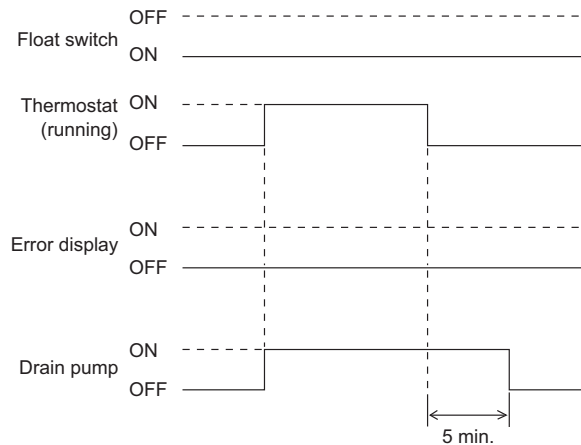

- ◆ The float switch is ON in normal operation.
- ◆ When cooling operation starts (thermostat ON), the drain pump turns ON simultaneously.
- ◆ After the thermostat turns OFF, the drain pump continues to operate for another 5 minutes.
- ◆ The aim of residual operation after thermostat OFF is to eliminate the dew that condenses on the indoor heat exchanger during cooling operation.

6.7.2 If the Float Switch is OFF with the Thermostat ON in Cooling Operation

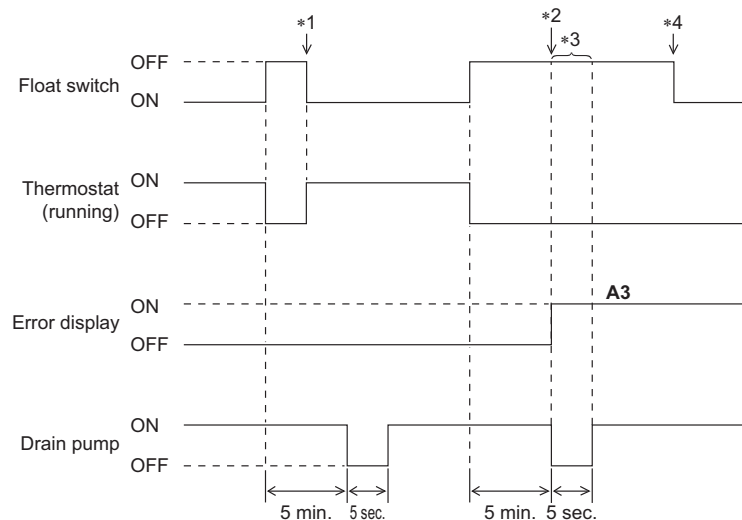

- ◆ When the float switch turns OFF, the thermostat turns OFF simultaneously.
- ◆ After the thermostat turns OFF, the drain pump continues to operate for another 5 minutes.
- *1. If the float switch turns ON again during the residual operation of the drain pump, cooling operation also turns on again (thermostat ON).
- *2. If the float switch remains OFF even after the residual operation of the drain pump has ended, the error code **A3** is displayed on the remote controller.
- *3. The drain pump turns OFF once residual operation has ended, then turns ON again after 5 seconds.
- *4. After **A3** is displayed and the unit comes to an abnormal stop, the thermostat will remain OFF even if the float switch turns ON again.

6.7.3 If the Float Switch is OFF with the Thermostat OFF in Cooling Operation

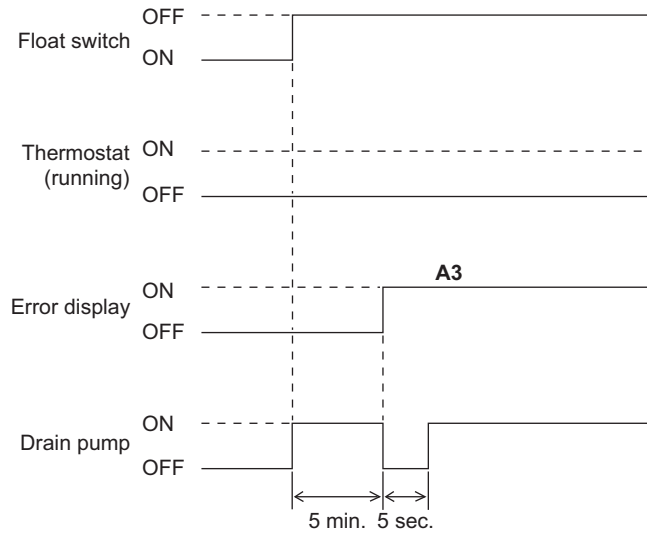

- ◆ When the float switch turns OFF, the drain pump turns ON simultaneously.
- ◆ If the float switch remains OFF even after the residual operation of the drain pump has ended, the error code **A3** is displayed on the remote controller.
- ◆ The drain pump turns OFF once residual operation has ended, then turns ON again after 5 seconds.

6.7.4 If the Float Switch Turns OFF and ON Continuously, or the Float Switch Turns OFF While AF Displayed

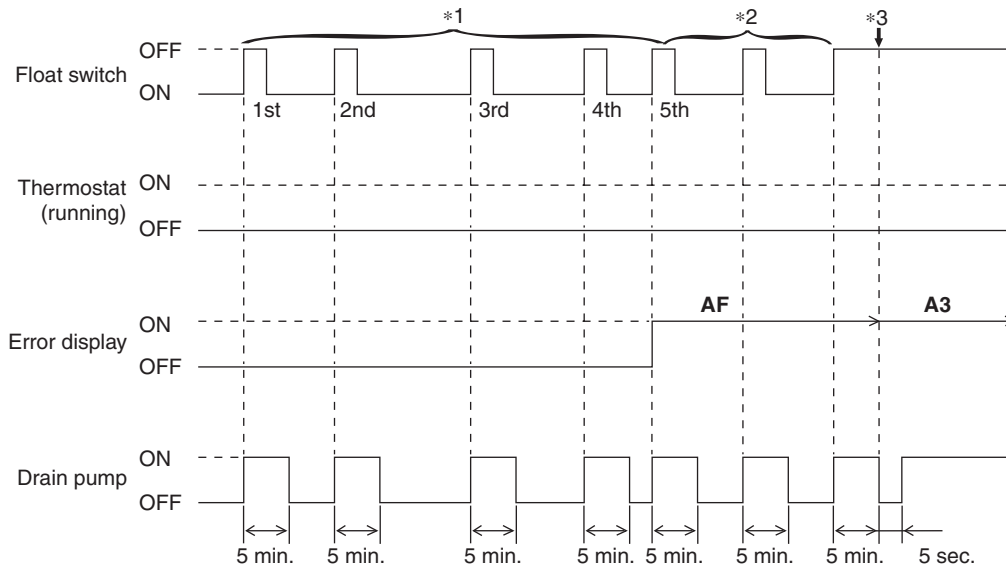

- ◆ When the float switch turns OFF, the drain pump turns ON simultaneously.
- *1: If the float switch continues to turn OFF and ON 5 times consecutively, it is judged as a drain system error and the error code **AF** is displayed on the remote controller.
- *2: The drain pump continues to turn ON/OFF in accordance with the float switch ON/OFF even after **AF** is displayed on the remote controller.
- *3: While the error code **AF** is displayed, if the float switch remains OFF even after the residual operation of the drain pump has ended, the error code **A3** will be displayed on the remote controller.

6.8 Freeze-Up Prevention

Freeze-Up Prevention by Off Cycle (Indoor Unit Individual Control)

When the temperature detected by the liquid pipe temperature thermistor of the indoor heat exchanger drops too low, the unit enters freeze-up prevention control in accordance with the following conditions, and is also set in accordance with the conditions given below. (Thermostat OFF)

When freeze-up prevention is activated, the electronic expansion valve is closed, the drain pump turns on and the airflow rate is fixed to L tap. When the following conditions for cancelling are satisfied, it will reset.

Conditions for starting:

Liquid pipe temperature $\leq -1^{\circ}\text{C}$ (30.2°F) (for total of 40 minutes)

or

Liquid pipe temperature $\leq -5^{\circ}\text{C}$ (23°F) (for total of 10 minutes)

Condition for cancelling:

Liquid pipe temperature $\geq +7^{\circ}\text{C}$ (44.6°F) (for 10 minutes continuously)

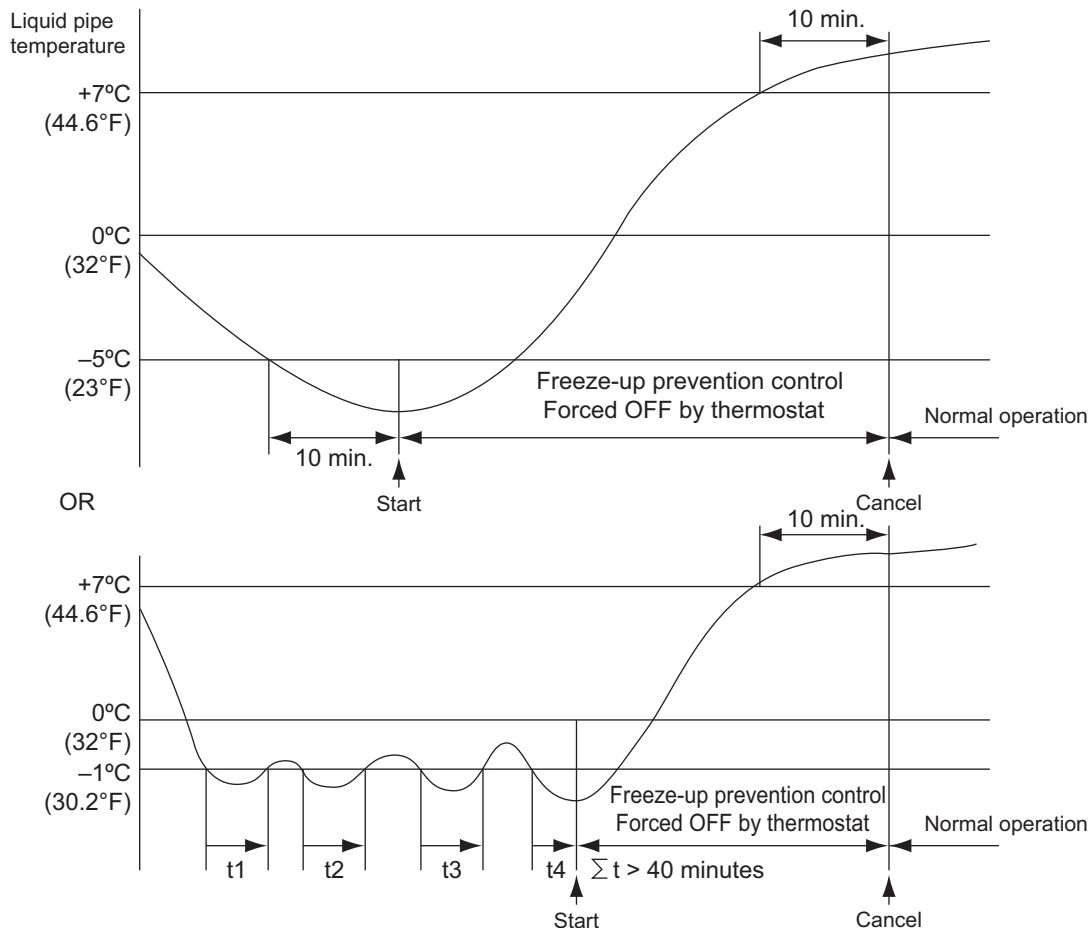

Concept of freeze-up prevention control

System avoids freeze-up

- ◆ For comfort, system avoids unnecessary thermostat ON/OFF
- ◆ For ensuring compressor reliability, system avoids unnecessary compressor ON/OFF

When freeze-up prevention control starts, system makes sure the frost is completely removed.

- ◆ System avoids water leakage.



Note(s)

When the indoor unit is FCQ, if the air outlet is set as dual-directional or tri-directional, the starting conditions will be changed as follows.

Liquid pipe temperature $\leq 1^{\circ}\text{C}$ (33.8°F) (for total of 15 minutes)

or

Liquid pipe temperature $\leq 0^{\circ}\text{C}$ (32°F) (for 1 minute continuously)

During freeze-up prevention operation, the airflow rate is fixed to LL.

(The cancelling conditions are same as the standard.)

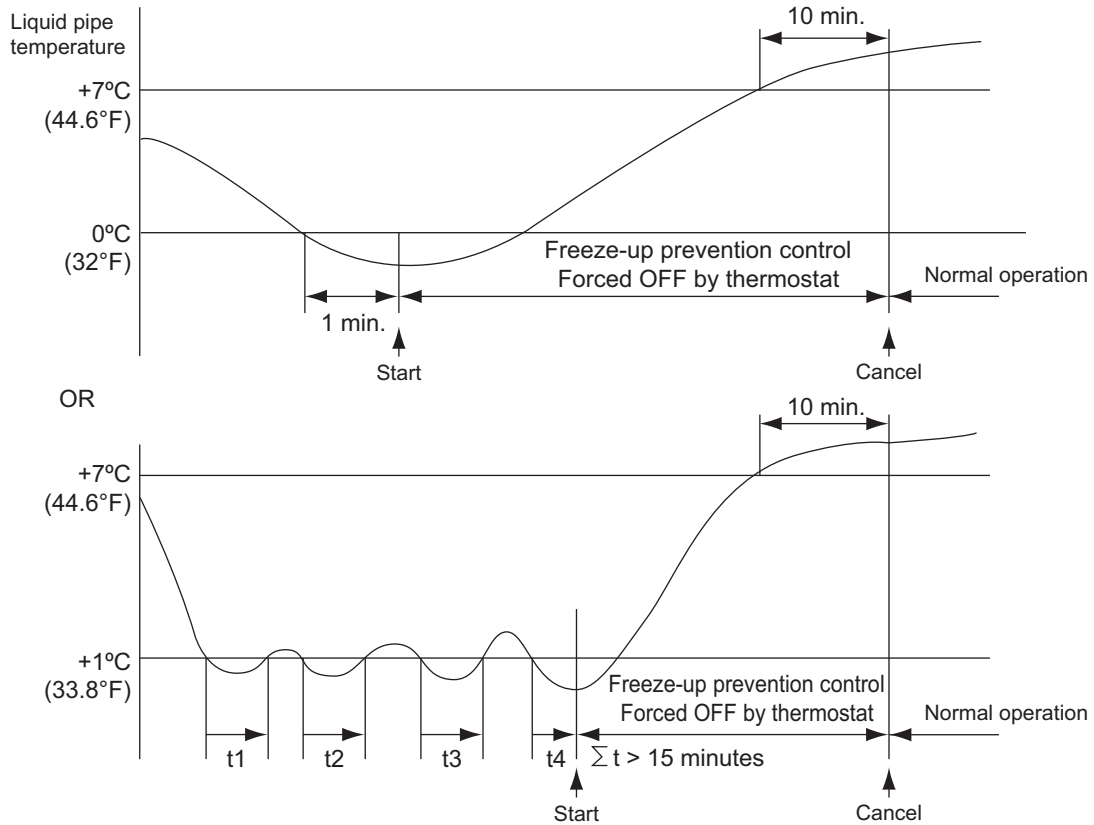

6.9 Heater Control (Except FTQ-TA Models)



Note(s) Optional PCB KRP1B... is required for heater control.

Heater control is conducted in the following manner.

Normal control

While in heating operation, heater control (ON/OFF) is conducted as shown on the right.

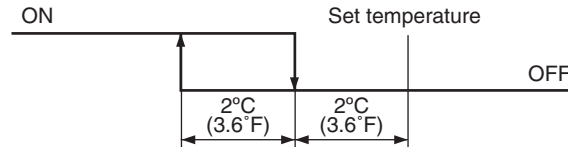

Overload control

When the system is overloaded in heating operation, the heater will be turned OFF in the following two manners.

(1) Heater control (ON/OFF) is conducted through the liquid pipe temperature (R2T) of the indoor unit.

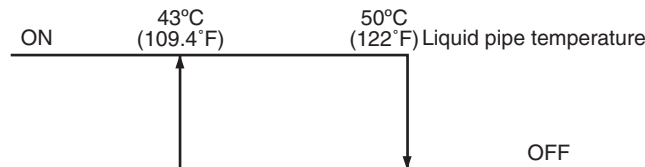

(2) Heater control (ON/OFF) is conducted by converting the heater temperature into the condensing pressure equivalent saturated temperature (Tc) according to the temperature detection through the high pressure sensor (S1NPH) of the outdoor unit.

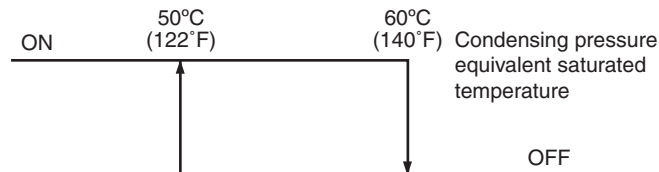

Fan residual operation

When the heater turns OFF, in order to prevent the activation of the thermal protector, the fan conducts residual operation for a given period of time after the heater turns OFF. (This operation is conducted regardless of whether or not a heater is equipped.)

Residual operation time: 100 seconds on ceiling suspended type or 60 seconds on other types

6.10 Heater Control (FTQ-TA Models)



Note(s)

Optional heater kit HKS... is required.

For FTQ-TA models, heater ON/OFF output from wiring adaptor interlocks with the operation of heater kit HKS....(When the heater 1 turns ON/OFF, heater output of wiring adaptor turns ON/OFF.) Fan residual operation also interlocks with the fan residual operation of heater kit HKS.... The residual time will be 90 seconds. (Refer to **Fan Control (Heater Residual) (FTQ-TA Models)** on page 176.)

6.10.1 Auxiliary Electric Heater Control

If heating is insufficient in heat pump system alone, an electric heater is to be used as the auxiliary heater. The following shows the ON/OFF conditions for the electric heater.

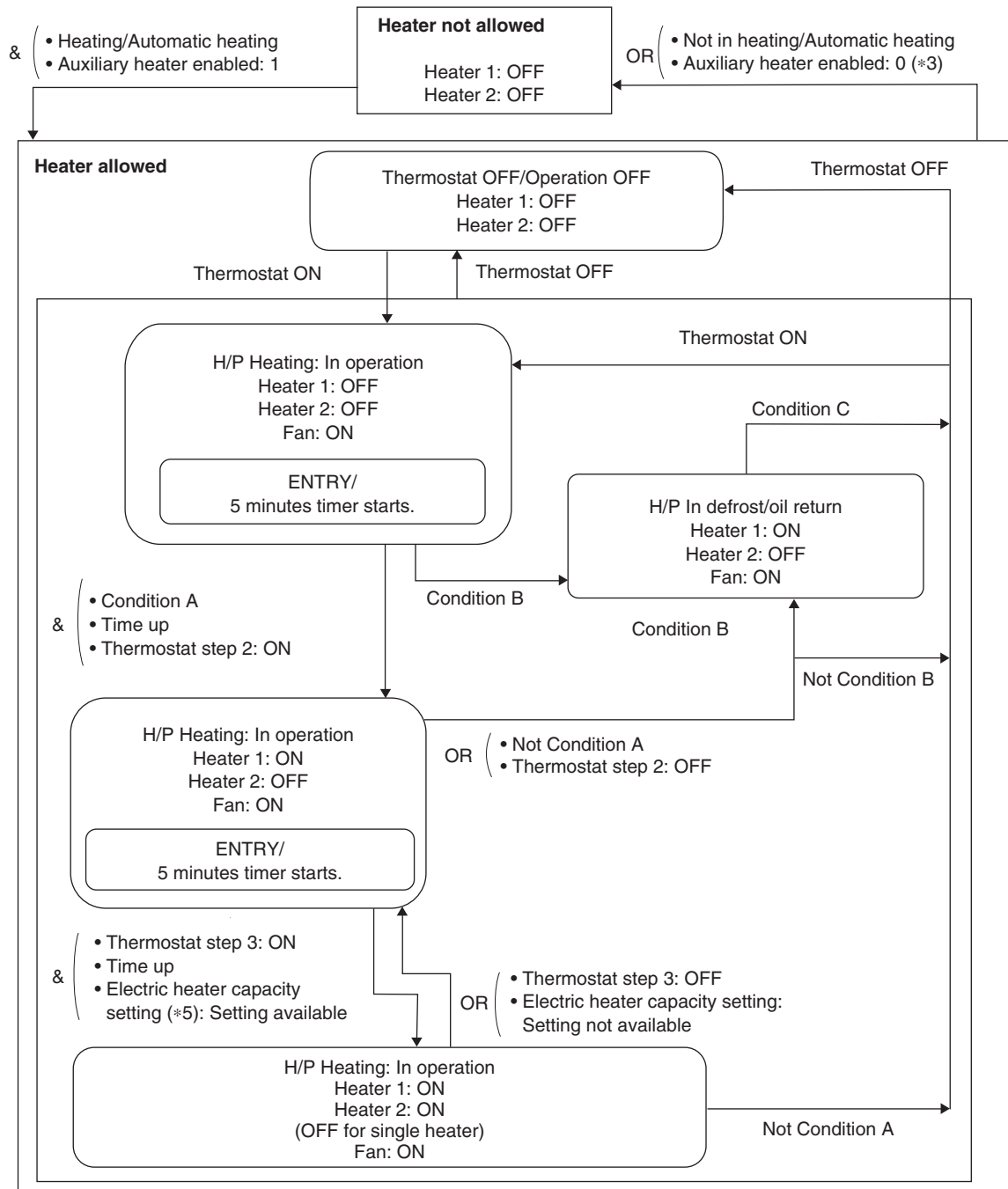

- Condition A
- No fan motor system error
 - High pressure condition: ON (*1)
 - Liquid pipe temperature condition: ON (*2)
- & (
- OR (
- Heater ON permission (Defrost/oil Return): 0 (*4)
 - Not during defrost/oil return
 - Heater ON permission (Defrost/oil return): 1 (*4)
- Condition B
- No fan motor system error
 - During defrost/oil return
 - Heater ON permission (Defrost/oil return): 1 (*4)
- Condition C
- Not during defrost/oil return
 - Fan motor system error
 - Heater ON permission (Defrost/oil return): 0 (*4)

i Note(s)

*1: High pressure condition

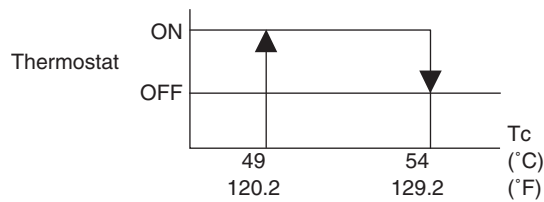

*2: Liquid pipe temperature condition

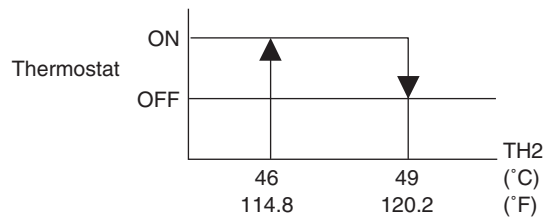

*3. Auxiliary heater enabled

- 1: & (
- Electric heater setting (Field setting 11 (21)-3.): **02, 08** (*6)
 - Electric heater capacity setting \neq **01**
- 0: Other than the above

*4. Heater ON permission (Defrost/oil return)

- 1: Electric heater setting (Field setting 11 (21)-3.): **08** (*6)
- 0: Electric heater setting (Field setting 11 (21)-3.): **02** (*6)

*5. Field setting 11 (21)-5. Refer to page 194.

*6. Field setting 11 (21)-3. Refer to page 194.

6.10.2 Heat Pump Lockout Control

For heating operation, users can select to use electric heater. For this, signals are sent using ABC terminal of outdoor unit PCB.

When the hot-water heating signal is received from the outdoor unit PCB, heating operation is performed only with the electric heater as manual backup operation. The ON/OFF conditions for the electric heater are shown below.

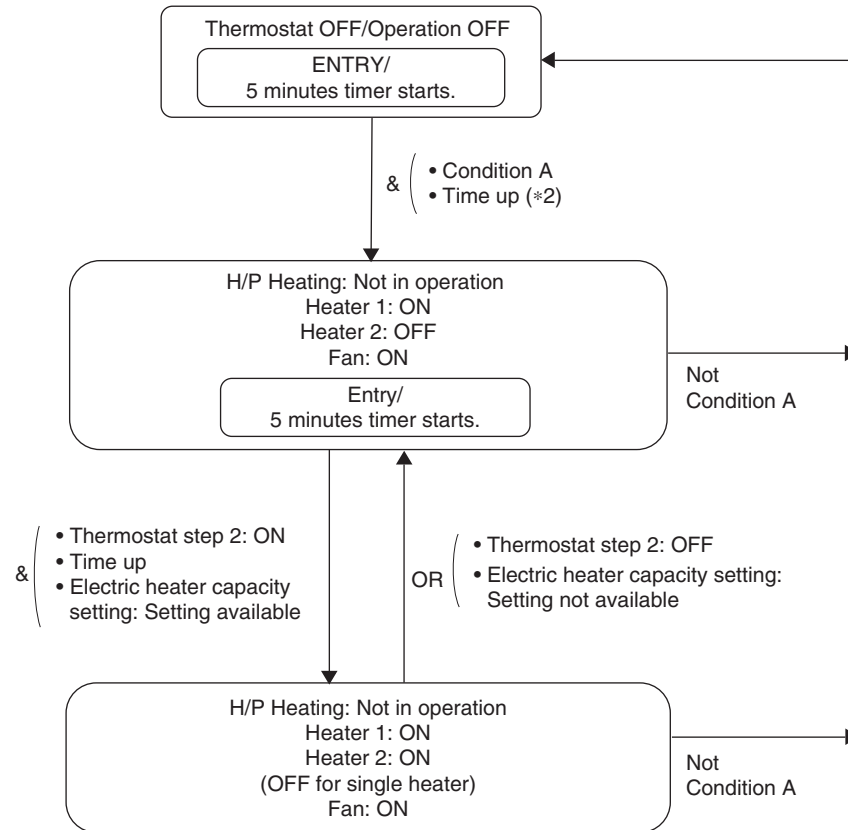

Condition A

- Heating or automatic heating mode
- Thermostat step 1: ON
- No fan motor system error
- Hot-water heater: 1 (ON)
- Heater backup prohibiting conditions (*1) not met (Not Condition B)

Condition B: Heater backup prohibiting conditions (*1)

- Indoor unit error (Abnormal stop)
- Indoor unit error (Remote controller thermistor error)
- Indoor unit error (Remote sensor error)
- Electric heater capacity setting: 01 (No heater kit)

i Note(s)

*1: The heater backup prohibiting conditions are prioritized. Even when the heater ON conditions are met, the heater is turned OFF when the prohibiting conditions are met.

*2: When the remote controller is ON, Time-up will be set to the initial value.

6.11 3-Step Thermostat Processing (FTQ-TA Models)

Outline

The thermostat ON/OFF for the indoor unit is controlled in accordance with Thermostat step 1.

The heater ON/OFF operation during heating is controlled as follows.

Thermostat step 2, 3: Auxiliary electric heater control

Thermostat step 1, 2: Heat pump lockout control

For more details of the heater, refer to **Heater Control (FTQ-TA Models)** on page 172.

Detail

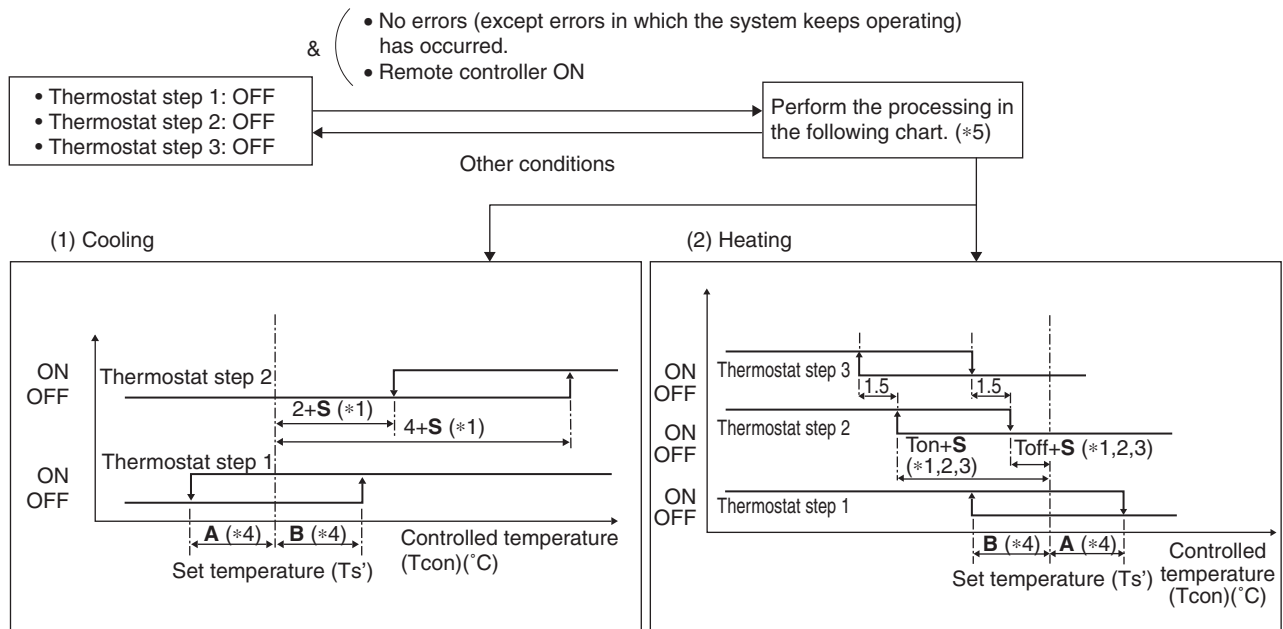

i Note(s)

- *1. **S** value varies automatically based on the room temperature trend.
- *2. $T_{on} + S > -B$ ($^{\circ}C$), $T_{off} + S < A$ ($^{\circ}C$)
- *3. For parameters, refer to page 193.
- *4. **A** and **B** values vary automatically based on the field setting 12 (22)-2.
- *5. If, directly after a change in conditions, it is such that the thermostat could be either ON or OFF (controlled temperature is within ranges **A** and **B**), the thermostat will be switched to ON.

6.12 Fan Control (Heater Residual) (FTQ-TA Models)

Outline

If the indoor heater turned OFF from ON during heating operation, the fan will keep operating for further period of time in order to cool the heater.

Detail

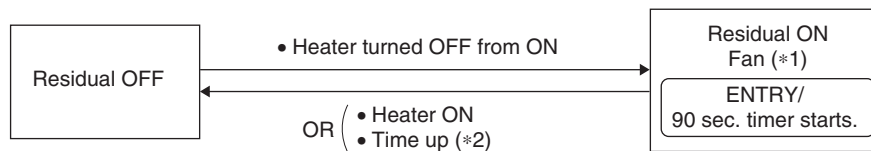

*1. When the heater is ON, the airflow rate of the fan will be whichever is the largest between the CFM dictated by the heater's own capacity, or the fan tap CFM determined by other controls.

*2. Fan residual operation will continue, even if the indoor unit is turned off with the remote controller operation button.

6.13 Interlocked with External Equipment (FTQ-TA Models)

6.13.1 Air Purifier (UV Lamp)

When an air purifier is connected onsite, the fan is operated with the airflow rate set of the remote controller or with the H tap.



*1. External input ON is an input signal to the X1M-AIR CLEANER terminal on the PCB.

*2. Field setting 14 (24)-4. Refer to page 201.

6.13.2 Humidifier

When a humidifier is connected onsite, the fan operates with the airflow rate set of the remote controller or with the H tap.



*1. External input ON is an input signal to the X1M-AIR CLEANER terminal on the PCB.

*2. Field setting 14 (24)-4. Refer to page 201.



Note(s)

This control is not applicable to the humidifier connected to the wiring adaptor, but to the humidifier connected to HUMIDIFIER on the X1M terminal of the indoor unit PCB.

6.13.3 Economizer

When indoor and outdoor air temperatures are reversed, the compressor is stopped to let in the outdoor air to save energy.

This operation is called economizer operation, and the equipment to detect indoor and outdoor air temperatures and open and close the damper to perform this operation is called an economizer.

The economizer detects indoor and outdoor air temperatures, informs the air conditioner that the economizer operation is ready, and opens and closes the damper.

The indoor unit stops the outdoor unit when it receives a signal from the economizer and performs air supply operation.

When the indoor air temperature is cooled down sufficiently by the economizer operation, and it is no longer necessary (thermostat OFF), the indoor unit outputs a signal to the economizer to close the damper.

■ Thermostat ON signal

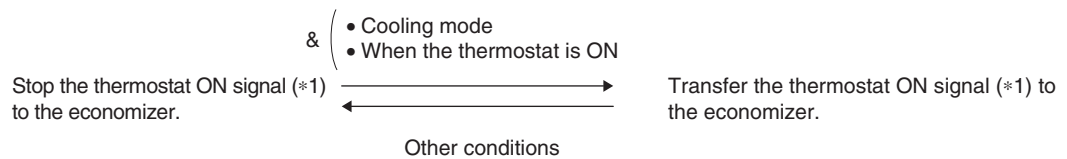

■ Operation

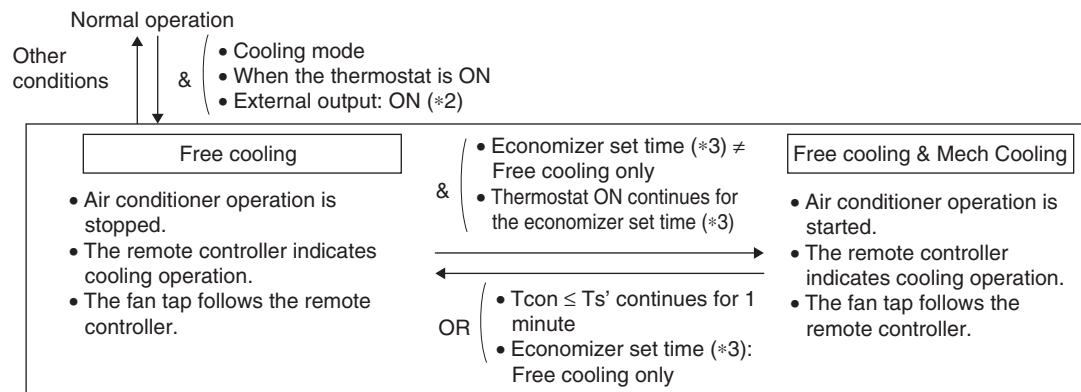

■ Indoor unit ON signal

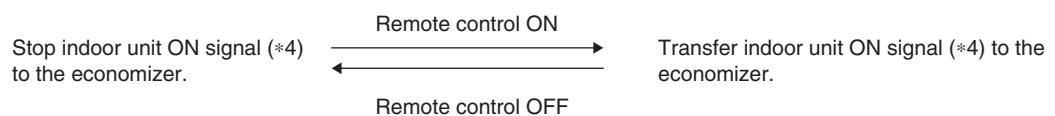

- *1 Thermostat ON signal: A signal to turn ON the indoor unit thermostat and allow the economizer to open the damper.
It turns ON the relay on the X2M-ECONOMIZER2 on the PCB.
- *2 External input ON is an input signal to the X1M-ECONOMIZER1 terminal on the PCB.
- *3 Refer to **Optional Kit Setting (UV lamp + Humidifier + Economizer) (for FTQ-TA models)** on page 201.
- *4 Remote control ON signal: Contact output which shows the operating status of the indoor unit.
This signal turns on the relay X2M-CONTROL ON/OFF on the PCB.

Part 5

Field Settings and Test Operation

1. Field Setting from Remote Controller	179
1.1 Wired Remote Controller	179
1.2 Simplified Remote Controller	184
1.3 Wireless Remote Controller	185
1.4 List of Field Settings for Indoor Unit	186
1.5 Details of Field Settings for Indoor Unit	190
1.6 Operation Control Mode	205
2. Field Settings from Outdoor Unit	206
2.1 Setting Mode and Monitor Mode	206
2.2 Setting Mode 1	207
2.3 Setting Mode 2	208
2.4 Monitor Mode	212
2.5 Setting of Low Noise Operation and Demand Operation	214
2.6 Setting of Refrigerant Recovery Mode	217
2.7 Setting of Vacuuming Mode	217
2.8 Check Operation	218
2.9 Setting of Auxiliary Heater Control	219
2.10 Setting of Heat Pump Lockout and Emergency Heat Mode	220
3. Test Operation	222
3.1 Check Work Prior to Turning Power Supply ON	222
3.2 Turn Power ON	222
3.3 Test Operation	223
3.4 Error Codes and Corresponding Measures	226
3.5 When Turning ON Power First Time	228
3.6 When Turning ON Power the Second Time and Subsequent	228
3.7 When an Indoor Unit or Outdoor Unit has been Added, or Indoor or Outdoor Unit PCB has been Changed	228

1. Field Setting from Remote Controller

Individual function of indoor unit can be changed from the remote controller. At the time of installation or after service inspection / repair, make the field setting in accordance with the following description.

Wrong setting may cause error.

(When optional accessory is mounted on the indoor unit, setting for the indoor unit may be required to change. Refer to information in the option handbook.)

1.1 Wired Remote Controller

1.1.1 BRC1E73

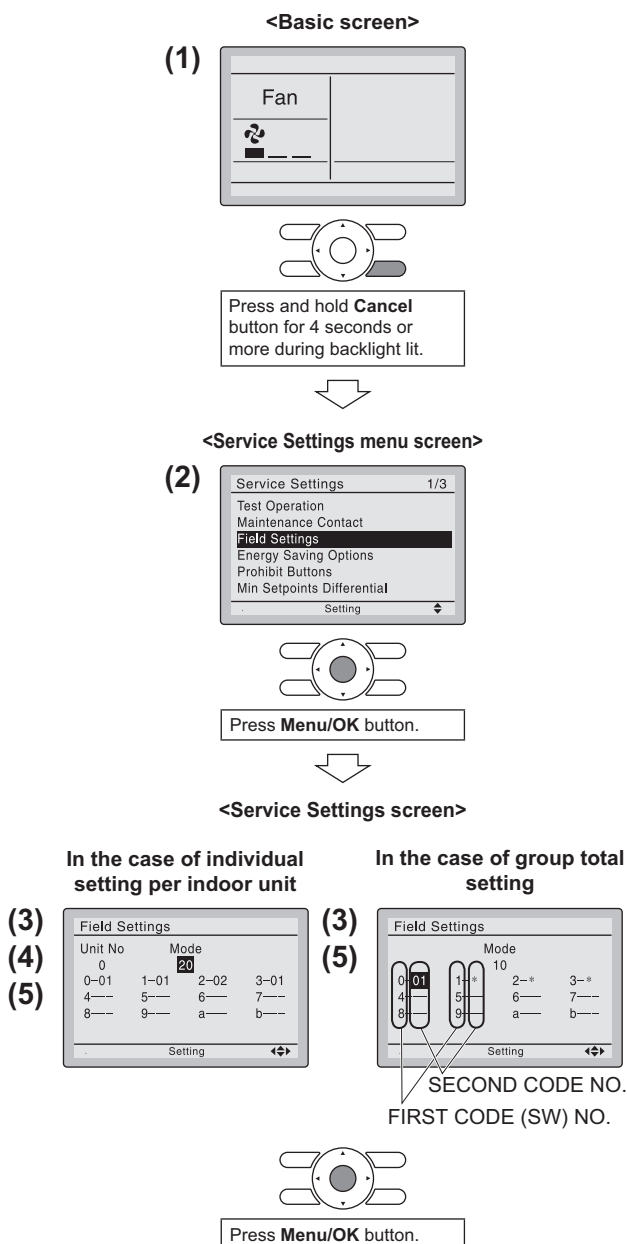

1. Press and hold **Cancel** button for 4 seconds or more.
Service settings menu is displayed.
2. Select **Field Settings** in the Service Settings menu, and press **Menu/OK** button.
Field settings screen is displayed.
3. Highlight the mode, and select desired "Mode No." by using **▲▼ (Up/Down)** button.
4. In the case of setting per indoor unit during group control (When Mode No. such as **20, 21, 22, 23, 25** are selected), highlight the unit No. and select "Indoor unit No." to be set by using **▲▼(Up/Down)** button.
(In the case of group total setting, this operation is not needed.)

In the case of individual setting per indoor unit, current settings are displayed. And, SECOND CODE NO. " - " means no function.

5. Highlight SECOND CODE NO. of the FIRST CODE NO. to be changed, and select desired "SECOND CODE NO." by using **▲▼ (Up/Down)** button. Multiple identical mode number settings are available.

In case of setting for all indoor units in the remote control group, available SECOND CODE NO. is displayed as "*" which means it can be changed. When SECOND CODE NO. is displayed as " - ", there is no function.

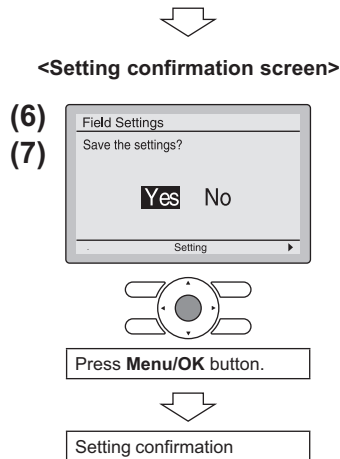

6. Press **Menu/OK** button. Setting confirmation screen is displayed.
7. Select **Yes** and press **Menu/OK** button. Setting details are determined and field settings screen returns.
8. In the case of multiple setting changes, repeat (3) to (7).
9. After all setting changes are completed, press **Cancel** button twice.
10. Backlight goes out, and **Checking the connection. Please standby.** is displayed for initialization. After the initialization, the basic screen returns.

**Note(s)**

- ◆ Installation of optional accessories on the indoor unit may require changes to field settings. See the manual of the optional accessory.
- ◆ For field setting details related to the indoor unit, see installation manual shipped with the indoor unit.

1.1.2 BRC1H71W

Enter the Installer Menu and make settings.

Installer menu screen

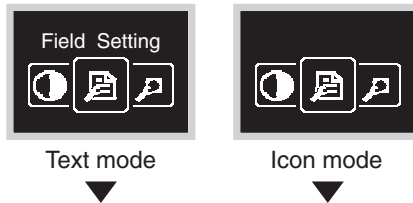

Press **←** or **→** button, for move to “”.
If Bluetooth is connected, performing field setting from the remote controller side is impossible.
Disconnect Bluetooth, or perform field setting from the mobile application.

Sub-menu screen

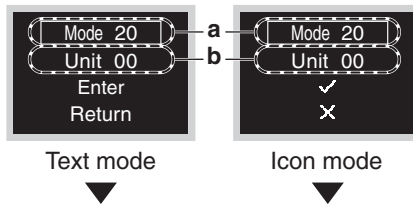

Press **+** or **-** button, to select Mode No. and press **○** to enter the field setting menu.
a Mode No.
b Unit No.

Sub-menu screen

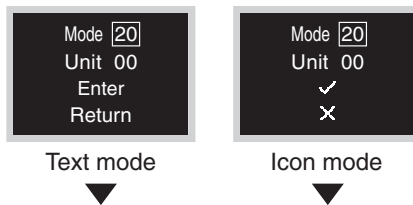

Press **←** or **→** button, to scroll the desired Mode No. and press **○** button.

Sub-menu screen

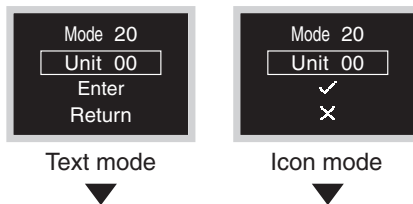

Press **←** or **→** button, to select Unit No. and press **○** button.

Sub-menu screen

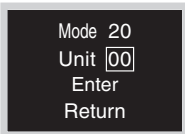

Text mode

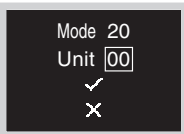

Icon mode

Press **←** or **→** button, scroll to the desired Unit No. and then press **○** button to set the selection.

Sub-menu screen

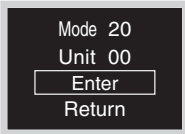

Text mode

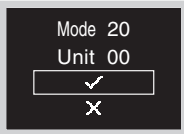

Icon mode

Press **←** or **→** button, to select “Enter” or “**✓**”, and then press **○** button to set the selection.

Sub-menu screen

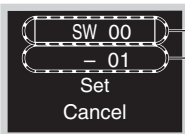

Text mode

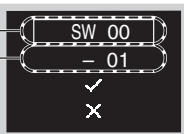

Icon mode

Press **←** or **→** button, select First Code No., and then press **○** button.
a First Code No.
b Second Code No.

Sub-menu screen

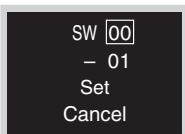

Text mode



Icon mode

Press **+** or **←** button, scroll to the desired First code No. and then press **○** button to set the selection.

Sub-menu screen



Text mode



Icon mode

Press **←** or **→** button, to move Second Code No., and then press **○** button.

Sub-menu screen



Text mode



Icon mode

Press **←** or **→** button, to scroll to the desired Second Code No., and then press **○** button.

Sub-menu screen



Text mode



Icon mode

Press **←** or **→** button, select “Set” or “**✓**”, and then press **○** button to save the setting and return to the previous screen.

If the setting is not changed, select “Cancel” or “**✕**”.

Sub-menu screen

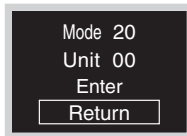

Text mode

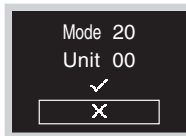

Icon mode

Press **←** or **→** button, move to “Return” or “**✕**”, and then press **○** button to return to the installer menu.

* If the setting has been changed, the screen may return to the home screen without returning to the installer menu.

⚠ CAUTION

- The connection of optional accessories to the indoor unit might cause changes to some field settings. For more information, see the installation manual of the optional accessory.
- For details about the specific field settings of each type of indoor unit, see the installation manual of the indoor unit.
- Field settings that are not available for a connected indoor unit are not displayed.
- Field setting default values are different depending on the indoor unit model.

⚠ NOTICE

- Installation of optional accessories on the indoor unit may require changes to field settings. See the manual of the optional accessory.
- For field setting details related to the indoor unit, see installation manual shipped with the indoor unit.

1.2 Simplified Remote Controller

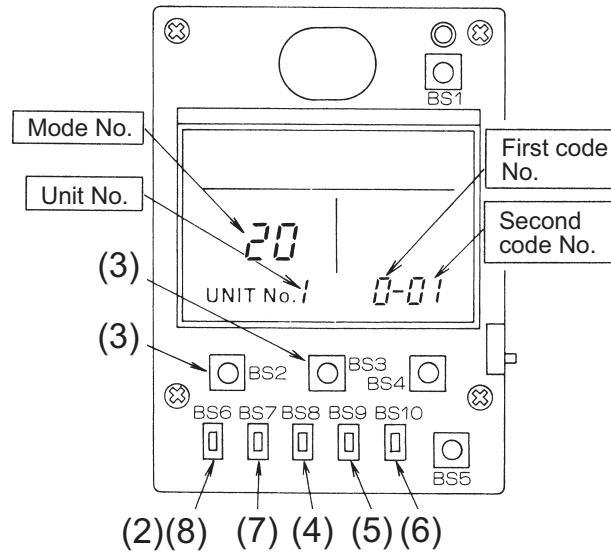

1. Remove the upper part of remote controller.
2. When in the normal mode, press the **BS6** button (2) (field setting) to enter the field setting mode.
3. Select the desired Mode No. with the **BS2** button (3) (temperature setting ▲) and the **BS3** button (3) (temperature setting ▼).
4. During group control, when setting by each indoor unit (mode No. 20, 22, and 23 have been selected), press the **BS8** (4) button (unit No.) and select the indoor unit No. to be set. (This operation is unnecessary when setting by group.)
5. Press the **BS9** button (5) (set A) and select first code No.
6. Press the **BS10** button (6) (set B) and select second code No.
7. Press the **BS7** button (7) (set/cancel) once and the present settings are confirmed.
8. Press the **BS6** button (8) (field setting) to return to the normal mode.

1.3 Wireless Remote Controller

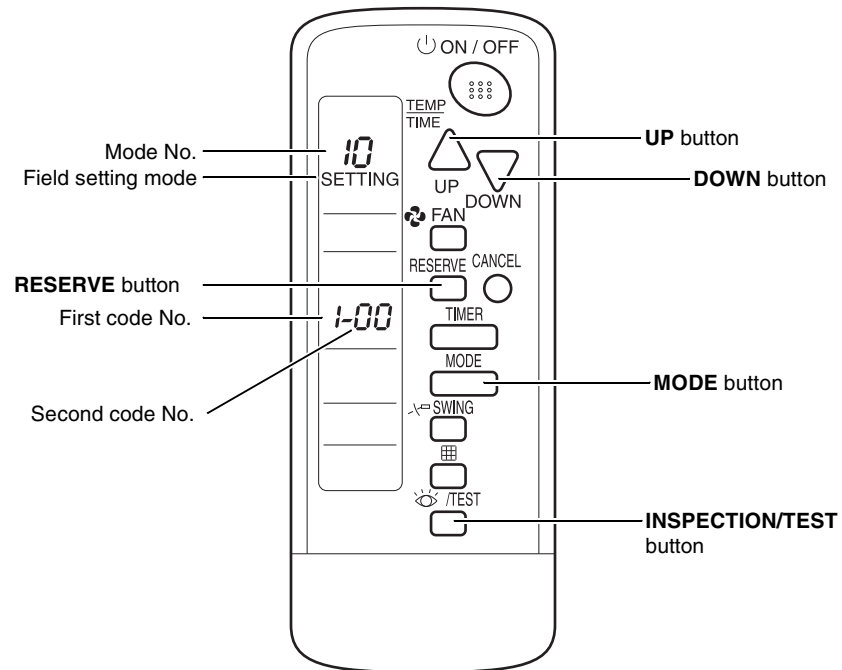

Setting

To set the field settings, you have to change:

- Mode No.
- First code No.
- Second code No.

To change the field settings, proceed as follows:

1. Press the **INSPECTION/TEST** button for 4 seconds during normal mode to enter the field setting mode.
2. Press the **MODE** button to select the desired mode No.
3. Press the **UP** button to select the first code No.
4. Press the **DOWN** button to select the second code No.
5. Press the **RESERVE** button to confirm the setting.
6. Press the **INSPECTION/TEST** button to return to the normal mode.

1.4 List of Field Settings for Indoor Unit

★: Factory setting

Mode No. (*2)	First Code No.	Description		Second Code No.				Reference Page		
				01	02	03	04			
10 (20)	0	Filter cleaning sign interval	Ultra long life filter	<u>Light</u> ★	<u>Approx. 10,000 hrs.</u> ★	Heavy	Approx. 5,000 hrs.	—	—	190
			Long life filter		<u>Approx. 2,500 hrs.</u> ★		Approx. 1,250 hrs.			
			Standard filter		<u>Approx. 200 hrs.</u> ★		Approx. 100 hrs.			
	0 (*8)	Filter sign setting	<u>Light</u> ★		Heavy		—	—	190	
	1	Filter type	<u>Long life filter</u> ★		Ultra long life filter		—	—	190	
	1 (*8)	Filter cleaning sign interval	<u>Short interval</u> ★		Long interval		—	—	190	
	2	Remote controller thermistor	<u>Remote controller thermistor + Suction air thermistor</u> ★		Only suction air thermistor	Only remote controller thermistor	—	—	190	
	2 (*8)	Remote sensor and remote controller thermistor	—		Only remote sensor thermistor	<u>Only remote controller thermistor</u> ★	—	—	190	
	3	Filter cleaning sign	<u>Displayed</u> ★		Not displayed		—	—	192	
6	Remote controller thermistor control during group control	<u>Not permitted</u> ★		Permitted		—	—	190		
7 (*6)	Time for absence area detection	<u>30 minutes</u> ★		60 minutes		—	—	192		
11 (21)	1 (*8)	Auxiliary electric heater ON temperature: Ton	Refer to the page on the right for details.						193	
	1	Auxiliary electric heater ON/OFF temperature: Ton/Toff								
	2 (*8)	Auxiliary electric heater OFF temperature: Toff								
	3	Setting of airflow rate when heating	<u>Standard</u> ★	Slightly increased	Increased	—	193			
	3 (*8)	Electric heater setting	Refer to the page on the right for details.						194	
	5 (*8)	Electric heater capacity setting	Refer to the page on the right for details.						194	
	6 (*6)	Setting the rate of human detection	High sensitivity	Low sensitivity	<u>Standard sensitivity</u> ★	Infrared presence sensor disabled	194			
	7	Automatic airflow adjustment	<u>OFF</u> ★	Completion of airflow adjustment	Start of airflow adjustment	—	195			
	8 (*6)	Compensating the temperature around people	Suction air temperature only	Priority given on the suction air temperature	<u>Standard</u> ★	Priority given on the floor temperature	196			
	9 (*6)	Compensating the floor temperature when heating	−4°C (−7.2°F)	−2°C (−3.6°F)	<u>0°C (0°F)</u> ★	2°C (3.6°F)	196			
12	Dry mode set temperature	<u>Room temperature</u> ★	Same as cooling mode set temperature	—	—	196				

Mode No. (*2)	First Code No.	Description	Second Code No.				Reference Page
			01	02	03	04	
12 (22)	0	Optional accessories output selection	Refer to the page on the right for details.				197
	1	External ON/OFF input	Refer to the page on the right for details.				197
	2	Thermostat differential changeover	1°C (1.8°F)	0.5°C (0.9°F)	—	—	197
	3 (*7)	Airflow setting when heating thermostat is OFF	LL tap★	Set fan speed	OFF	—	198
	4	Automatic mode differential	Refer to the page on the right for details.				198
	5	Auto restart after power failure	OFF	ON★	—	—	198
	6 (*7)	Airflow setting when cooling thermostat is OFF	LL tap	Set fan speed★	OFF	—	198
13 (23)	0	Ceiling height setting, Setting of normal airflow	Standard★	High ceiling (1)	High ceiling (2)	—	199
	1	Airflow direction setting	4-direction airflow★	3-direction airflow	2-direction airflow	—	199
	2 (*6)	Swing pattern settings	All direction synchronized swing	—	Facing swing★	—	200
	4	Airflow direction adjustment range	Draft prevention	Standard★	Ceiling Soiling prevention	—	200
	6	External static pressure settings	Refer to the page on the right for details.				200
14 (24)	4 (*8)	Optional kit setting (UV lamp + humidifier + economizer)	Refer to the page on the right for details.				201
	5 (*8)	Dry mode set temperature	Room temperature★	Same as cooling mode set temperature	—	—	201
15 (25)	0	Drain pump operation settings	—	ON★	OFF	—	201
	1	Humidification when heating thermostat is OFF	Not equipped★	Equipped	—	—	201
	2 (*5)	Direct duct connection	Not equipped★	Equipped	—	—	202
	3	Drain pump and humidifier interlock selection	Not interlocked★	Interlocked	—	—	202
	5	Individual ventilation setting	Normal★	Individual	—	—	202
1b	4	Display of error codes on the remote controller	—	Two-digit display	—	Four-digit display★	202
1c	0	Room temperature display	Room temperature is not displayed	Room temperature is displayed★	—	—	202
	1	Thermistor sensor for auto changeover and setback control by the remote controller	Utilize the return air thermistor	Utilize the remote controller thermistor★	—	—	203
	3	Access permission level setting	Level 2★	Level 3	—	—	203
1e	2	Setback availability	N/A★	Heat only	Cool only	Cool/heat	203
	14	Setting restricted/permitted of airflow block	Refer to the page on the right for details.				204

**Note(s)**

1. Settings are made simultaneously for the entire group, however, if you select the mode No. inside parentheses, you can also set by each individual unit. Setting changes however cannot be checked except in the individual mode for those in parentheses.
- *2. The mode numbers inside parentheses cannot be used by wireless remote controllers, so they cannot be set individually. Setting changes also cannot be checked.
3. Do not make settings other than those described above. Nothing is displayed for functions the indoor unit is not equipped with.
4. **88 or Checking the connection. Please stand by.** may be displayed to indicate the remote controller is resetting when returning to the normal mode.
- *5. If the setting mode set to Equipped, energy recovery ventilator fan conducts the fan residual operation by linking to indoor unit.
- *6. Available for setting when option with the built-in human detection and floor temperature detection functions are mounted.

*7. If the airflow setting when thermostat is OFF is set to OFF (12 (22)-3-03, 12 (22)-6-03), the air in the indoor unit will be stagnant and suction air thermistor may not detect room temperature correctly, resulting in problems that thermostat will not be ON easily.

Use optional remote sensor in such conditions, or set the field setting 10 (20)-2 to **03** (only remote controller thermistor).

*8. Only for FTQ-TA models.

Applicable Range of Field Settings

Mode No.	First Code No.	Description of Setting	FCQ-TA	FCQ-AA	FHQ-P FHQ-M	FAQ-TA	FBQ-P	FBQ-TB	FTQ-TA
10 (20)	0	Filter cleaning sign interval	●	●	●	●	●	●	—
	0	Filter sign setting	—	—	—	—	—	—	●
	1	Filter type	●	●	—	—	—	●	—
	1	Filter cleaning sign interval	—	—	—	—	—	—	●
	2	Remote controller thermistor	●	●	●	●	●	●	●
	3	Filter sign display	●	●	●	●	●	●	●
	6	Remote controller thermistor control during group control	●	●	●	●	●	●	●
	7	Time for absence area detection	●	●	—	—	—	—	—
11 (21)	1	Auxiliary electric heater ON temperature	—	●	—	—	—	●	●
	1	Auxiliary electric heater ON/OFF temperature	●	—	—	—	—	—	—
	2	Auxiliary electric heater OFF temperature	—	●	—	—	—	●	●
	3	Setting of airflow rate when heating	●	●	—	—	—	—	—
	3	Electric heater setting	—	—	—	—	—	—	●
	5	Electric heater capacity setting	—	—	—	—	—	—	●
	6	Setting the rate of human detection	●	●	—	—	—	—	—
	7	Automatic airflow adjustment	—	—	—	—	●	●	—
	8	Compensating the temperature around people	●	●	—	—	—	—	—
	9	Compensating the floor temperature when heating	●	●	—	—	—	—	—
12 (22)	0	Optional accessories output selection	●	●	●	●	●	●	●
	1	External ON/OFF input	●	●	●	●	●	●	●
	2	Thermostat differential changeover	●	●	●	●	●	●	●
	3	Airflow setting when heating thermostat is OFF	●	●	●	●	●	●	●
	4	Automatic mode differential	●	●	●	●	●	●	●
	5	Auto restart after power failure reset	●	●	●	●	●	●	●
	6	Airflow setting when cooling thermostat is OFF	●	●	●	●	●	●	●
13 (23)	0	Ceiling height setting, Setting of normal airflow	●	●	●	●	—	—	—
	1	Airflow direction setting	●	●	—	●	—	—	—
	2	Swing pattern settings	●	●	—	—	—	—	—
	4	Airflow direction adjustment range	●	●	—	●	—	—	—
	6	External static pressure settings	—	—	—	—	●	●	—
14 (24)	4	Optional kit setting (UV lamp + humidifier + economizer)	—	—	—	—	—	—	●
	5	Dry mode set temperature	—	—	—	—	—	—	●
15 (25)	0	Drain pump operation settings	—	—	—	—	●	—	—
	1	Humidification when heating thermostat is OFF	●	●	●	●	●	●	●
	2	Direct duct connection	●	●	—	●	—	—	—
	3	Drain pump and humidifier interlock selection	●	●	●	●	●	●	—
	5	Individual ventilation setting	●	●	●	●	●	●	●
1b	4	Display of error codes on the remote controller	●	●	●	●	●	●	●
1c	0	Room temperature display	●	●	●	●	●	●	●
	1	Thermistor sensor for auto changeover and setback control by the remote controller	●	●	●	●	●	●	●
	3	Access permission level setting	●	●	●	●	●	●	●
1e	2	Setback availability	●	●	●	●	●	●	●
	14	Setting restricted/permitted of airflow block	●	●	—	—	—	—	—

●: Available

—: Not available

1.5 Details of Field Settings for Indoor Unit

1.5.1 Filter Cleaning Sign Interval, Filter Type

When the setting 10 (20)-3 is set to **01** (Displayed), filter cleaning sign is displayed on the remote controller after a certain period of operation time. This setting is used to change the display interval of filter cleaning sign when the filter contamination is heavy.

The filter cleaning sign interval is determined as follows depending on the combination of Mode No. 10 (20)-0 and 10 (20)-1.

★: Factory setting

Setting	10 (20)-1	01: Long life filter★		02: Ultra long life filter	
	Filter contamination heavy/light 10 (20)-0	Light 01★	Heavy 02	Light 01	Heavy 02
Model	FCQ-TA	2,500 hrs.★	1,250 hrs.	10,000 hrs.	5,000 hrs.
	FCQ-AA				
	FHQ-P				
	FHQ-M				
	FBQ-P				
	FBQ-TB				
	FAQ-TA	200 hrs.★	100 hrs.	200 hrs.	100 hrs.

Setting	10 (20)-1	01: Short interval★		02: Long interval	
	Filter contamination heavy/light 10 (20)-0	Light 01★	Heavy 02	Light 01	Heavy 02
Model	FTQ-TA	2,500 hrs.★	1,250 hrs.	10,000 hrs.	5,000 hrs.

1.5.2 Remote Controller Thermistor

Select a thermistor to control the room temperature.

When the unit is not equipped with an infrared floor sensor:

★: Factory setting

Mode No.	First Code No.	Second Code No.	Contents
10 (20)	2	01★	Remote controller thermistor and suction air thermistor for indoor unit★
		02	Suction air thermistor for indoor unit
		03	Remote controller thermistor

The factory setting for the Second Code No. is **01** and room temperature is controlled by the suction air thermistor for indoor unit and remote controller thermistor. When the Second Code No. is set to **02**, room temperature is controlled by the suction air thermistor. When the Second Code No. is set to **03**, room temperature is controlled by the remote controller thermistor.



Note(s)

For FCQ-AA and FBQ-TB, the factory setting for the Second Code No. is **02**.

■ FTQ-TA

★: Factory setting

Mode No.	First Code No.	Second Code No.	Contents
10 (20)	2	01	—
		02	Remote sensor thermistor
		03★	Remote controller thermistor★

When the Second Code No. is set to **02**, room temperature is controlled by the remote sensor thermistor. When the Second Code No. is set to **03**, room temperature is controlled by the remote controller thermistor.

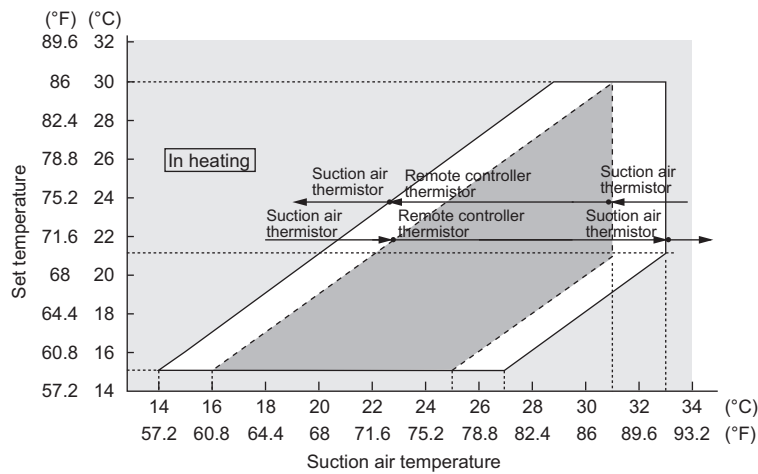
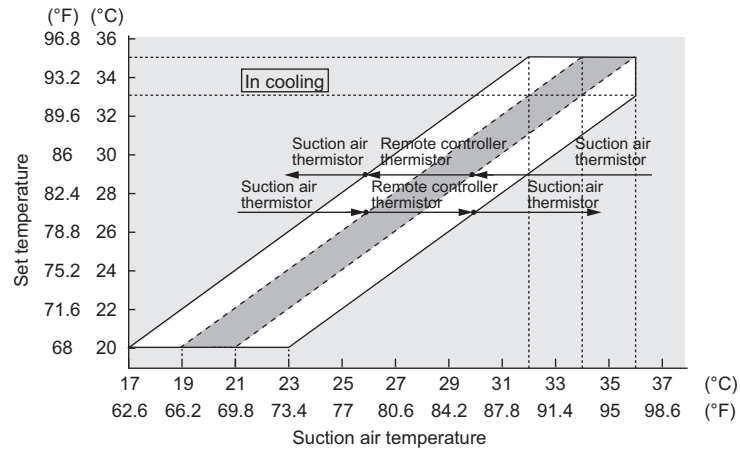

When the unit is equipped with an infrared floor sensor:

★: Factory setting

Mode No.	First Code No.	Second Code No.					
		01	02	02	02★	02	03
10 (20)	2	01	02	02	02★	02	03
11 (21)	8	01	01	02	03★	04	01
The thermistor to be used		↓	↓	↓	↓	↓	↓
Remote controller thermistor		●	—	—	—	—	●
Suction air thermistor		●	●	●	●	●	—
Infrared floor sensor		—	—	●	●	●	—
		↓	↓	↓	↓	↓	↓
		The infrared floor sensor is not used	Priority given to the suction air temperature (*)		Priority given to the floor temperature (*)		
		Only the suction air thermistor is used	Standard setting (Factory setting)		Only the remote controller thermistor is used		

*Refer to **Compensating the temperature around people** on page 196.

Note that the control is automatically switched to the one performed only by the suction air thermistor for indoor unit when the Second code No. is **01** during group control.

To use the remote controller thermistor during the group control, select the Second code No. **02** in First code No. **6**.

★: Factory setting

Mode No.	First Code No.	Second Code No.	Contents
10 (20)	6	01★	Remote controller thermistor control is not permitted during group control★
		02	Remote controller thermistor control is permitted during group control



Note(s)

When the 10 (20)-6 setting is changed to **02**, several indoor units are controlled by one remote controller thermistor, so note that the room temperature might be uneven.

1.5.3 Filter Cleaning Sign

Whether or not to display **Filter Cleaning** after operation of a certain duration can be selected.

★: Factory setting

Mode No.	First Code No.	Second Code No.	Contents
10 (20)	3	01★	Displayed★
		02	Not displayed

***Filter Cleaning** is not displayed when an Auto-clean Panel is connected.

1.5.4 Time for Absence Area Detection

(For units with an infrared presence sensor)

By selecting the energy-saving operation mode when absent, the target temperature is shifted to the energy-saving end by 1°C (1.8°F) (maximum 2°C (3.6°F)) after the state of absence continues for a certain period of time.

Absent time defined for detection can be selected as follows:

★: Factory setting

Mode No.	First Code No.	Second Code No.	Contents
10 (20)	7	01★	30 minutes★
		02	60 minutes

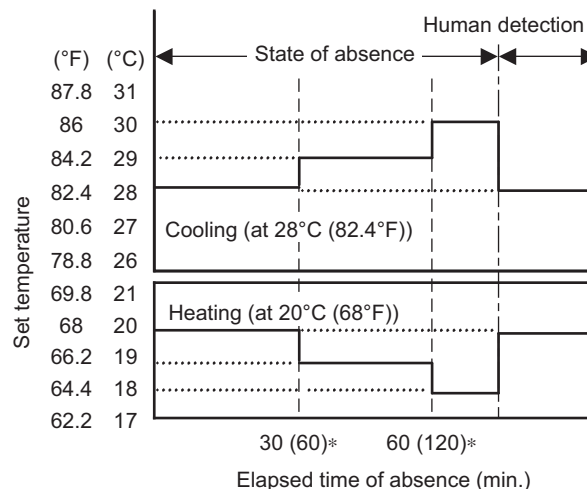

* The values in parentheses represent the time when Second code No. is **02**.

- The set temperature displayed on the remote controller remains the same even if the target temperature is shifted.
- As soon as people are detected while the temperature is shifted, this control will be cancelled (reset).

1.5.5 Auxiliary Electric Heater ON/OFF Temperature

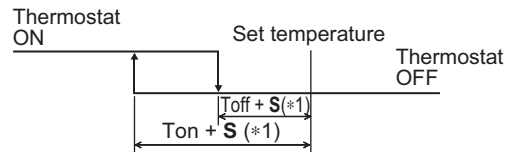

Note(s) *1. S value varies automatically based on the room temperature trend.

■ FCQ-TA

★: Factory setting

Mode No.	First Code No.	Symbol	Second Code No.					
			01★	02	03	04	05	06
11 (21)	1	Ton	-4°C (-7.2°F) ★	-3.5°C (-6.3°F)	-3°C (-5.4°F)	-2.5°C (-4.5°F)	-2°C (-3.6°F)	-1.5°C (-2.7°F)
		Toff	-2°C (-3.6°F) ★	-1.5°C (-2.7°F)	-1°C (-1.8°F)	-0.5°C (-0.9°F)	0°C (0°F)	0.5°C (0.9°F)

■ FCQ-AA, FBQ-TB, FTQ-TA

★: Factory setting

Mode No.	First Code No.	Symbol	Second Code No.					
			01★	02	03	04	05	06
11 (21)	1	Ton	-4°C (-7.2°F) ★	-3.5°C (-6.3°F)	-3°C (-5.4°F)	-2.5°C (-4.5°F)	-2°C (-3.6°F)	-1.5°C (-2.7°F)
	2	Toff	-2°C (-3.6°F) ★	-1.5°C (-2.7°F)	-1°C (-1.8°F)	-0.5°C (-0.9°F)	0°C (0°F)	0.5°C (0.9°F)

There is a limitation of combination between Ton and Toff as below due to 2°C (3.6°F) hysteresis required for reliability.

Second Code No.			Ton					
			01	02	03	04	05	06
			-4°C (-7.2°F)	-3.5°C (-6.3°F)	-3°C (-5.4°F)	-2.5°C (-4.5°F)	-2°C (-3.6°F)	-1.5°C (-2.7°F)
Toff	06	0.5°C (0.9°F)	●	●	●	●	●	●
	05	0°C (0°F)	●	●	●	●	●	—
	04	-0.5°C (-0.9°F)	●	●	●	●	—	—
	03	-1°C (-1.8°F)	●	●	●	—	—	—
	02	-1.5°C (-2.7°F)	●	●	—	—	—	—
	01	-2°C (-3.6°F)	●	—	—	—	—	—

●: Available

—: Not available

1.5.6 Setting of Airflow Rate when Heating

The fan revolution is changed to maintain the sufficient distance for warm air to reach during the heating operation. The setting should be changed depending on the installation condition of the unit.

★: Factory setting

Mode No.	First Code No.	Second Code No.	Contents
11 (21)	3	01★	Standard★
		02	Slightly increased
		03	Increased

Note that this setting is effective only during the heating operation.

1.5.7 Electric Heater Setting

■ FTQ-TA

★: Factory setting

Mode No.	First Code No.	Second Code No.	Contents	
			Heater operation	Electric heater run for defrost/oil return operation
11 (21)	3	01★	Electric heater with heat pump not allowed★	Not allowed★
		02	Electric heater with heat pump allowed	Not allowed
		07	Electric heater with heat pump not allowed	Allowed
		08	Electric heater with heat pump allowed	Allowed

1.5.8 Electric Heater Capacity Setting

■ FTQ-TA

★: Factory setting

Model	Mode No.	First Code No.	Second Code No.							
			01★	02	03	04	05	06	07	08
			Heater (kW)							
			No heater kit★	3	5	6	8	10	15	19
FTQ18TA	11 (21)	5	●★	●	●	●	●	●	—	—
FTQ24TA			●★	●	●	●	●	●	—	—
FTQ30TA			●★	●	●	●	●	●	—	—
FTQ36TA			●★	●	●	●	●	●	—	—
FTQ42TA			●★	—	●	●	●	●	●	●
FTQ48TA			●★	—	●	●	●	●	●	●

●: Available

—: Not available

1.5.9 Setting the Rate of Human Detection

(For units with an infrared presence sensor)

Set the sensitivity of the infrared presence sensor.

■ The infrared presence sensor can be disabled by selecting the Second code No. **04**.

Note(s)

When the infrared presence sensor is disabled, the remote controller menu does not display some functions such as the automatic draft reduction, energy-saving operation in absence and halt in absence.

★: Factory setting

Mode No.	First Code No.	Second Code No.	Contents
11 (21)	6	01	High sensitivity
		02	Low sensitivity
		03★	Standard sensitivity★
		04	Infrared presence sensor disabled

1.5.10 Automatic Airflow Adjustment

Make external static pressure setting automatically using automatic airflow adjustment, or manually using external static pressure settings.

The volume of blow-off air is automatically adjusted to the rated quantity.

Make settings before performing the test operation of the outdoor unit.

Setting procedure

1. Make sure that electric wiring and duct construction have been completed.
In particular, if the closing damper is installed on the way of the duct, make sure that it is open.
In addition, make sure that a field-supplied air filter is installed within the air passageway on the suction port side.
2. If there are multiple blow-off and suction ports, adjust the throttle part so that the airflow volume ratio of each suction/blow-off port conforms to the designed airflow volume ratio. In that case, operate the unit with the operation mode "fan". When you want to change the airflow rate, adjust it by pressing the airflow rate control button to select High, Middle or Low.
3. Make settings to adjust the airflow rate automatically.
After setting the operation mode to "fan", enter the field setting mode while operation is stopped and then select the Mode No. 11 (21), set the First Code No. to **7** and the Second Code No. to **03**.
4. After setting, return to the basic screen (to the normal mode in the case of a wireless remote controller) and press the ON/OFF button. Fan operation for automatic airflow adjustment will start with the operation lamp turned ON. Do not adjust the throttle part of the suction and blow-off ports during automatic adjustment. After operation for approximately one to fifteen minutes, airflow adjustment automatically stops with the operation lamp turned OFF.
5. After operation stopped, make sure that the Second Code No. is set to **02** as in the following table by indoor unit with the Mode No. 11 (21). If operation does not stop automatically or the Second Code No. is not set to **02**, return to the step (3) above to make settings again.

★: Factory setting

Mode No.	First Code No.	Second Code No.	Contents
11 (21)	7	01★	OFF★
		02	Completion of airflow adjustment
		03	Start of airflow adjustment



Note(s)

1. Make sure that the external static pressure is within the range of specifications before making settings. If it is outside the range, automatic adjustment fails, which may cause an insufficient airflow volume or leakage of water.
2. If the air passageway including duct or blow-off ports is changed after automatic adjustment, make sure to perform automatic airflow adjustment again.

1.5.11 Compensating the Temperature around People

(For units with an infrared floor sensor)

Change the ratio between the suction air temperature and floor temperature used to calculate the temperature around people.

The temperature around people is calculated using the values of the suction air thermistor and the infrared floor sensor. The factory setting is Normal (the average value of the suction air temperature and the floor temperature is applied). However, the rate at which the suction air thermistor and the infrared floor sensor affect the temperature around people can be changed with this setting.

- To reflect the effect of the temperature around the ceiling, select the "Priority given on the suction air temperature" (the Second code No. **02**).
- To reflect the effect of the temperature around the floor, select the "Priority given on the floor temperature" (the Second code No. **04**).
- The infrared floor sensor can be disabled by selecting "Suction air temperature only" (the Second code No. **01**).

★: Factory setting

Mode No.	First Code No.	Second Code No.	Contents
11 (21)	8	01	Suction air temperature only
		02	Priority given on the suction air temperature
		03★	Standard★
		04	Priority given on the floor temperature

1.5.12 Compensating the Floor Temperature when Heating

(For units with an infrared floor sensor)

Offset the detected value of the infrared floor sensor with a certain temperature. This setting should be used to have the actual floor temperature detected when, for example, the unit is installed close to a wall.

★: Factory setting

Mode No.	First Code No.	Second Code No.	Contents
11 (21)	9	01	-4°C (-7.2°F)
		02	-2°C (-3.6°F)
		03★	0°C (0°C)★
		04	+2°C (+3.6°F)

Actual procedure to use the setting

Although the standard setting is normally used with no problem, the setting should be changed in the following cases:

Environment	Operation Mode	Problem	Setting Value
- The unit is installed close to a wall or a window. - High thermal capacity of the floor (such as concrete, etc). - There are many heat sources including PC. - There is a non-negligible heat source such as floor heating.	Heating	Excessive heating	+2°C (+3.6°F)
		Insufficient heating	-2°C or -4°C (-3.6°F or -7.2°F)

1.5.13 Dry Mode Set Temperature (for FCQ-AA and FBQ-TB Models)

★: Factory setting

Mode No.	First Code No.	Second Code No.	Contents
11 (21)	12	01★	Room temperature★
		02	Same as cooling mode set temperature

1.5.14 Optional Accessories Output Selection

Using this setting, "operation output signal" and "abnormal output signal" can be provided. Output signal is output between terminals X1 and X2 of "adaptor for wiring", an optional accessory.

★: Factory setting

Mode No.	First Code No.	Second Code No.	Contents
12 (22)	0	01★	Indoor unit thermostat ON/OFF signal is provided.★
		02	—
		03	Output linked with ON/OFF of remote controller is provided.
		04	In case of Error Display appears on the remote controller, output is provided.
		05	—
		06	—
		07	Only for FBQ-TB Economizer (field supply) ON/OFF signal is provided.

1.5.15 External ON/OFF Input

This input is used for "ON/OFF operation" and "Protection device input" from the outside. The input is performed from the T1-T2 terminal of the operation terminal block in the electrical component box.

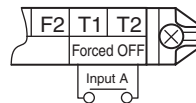

★: Factory setting

Mode No.	First Code No.	Second Code No.	Contents
12 (22)	1	01★	ON: Forced OFF (prohibition of using the remote controller) OFF: Permission of using the remote controller★
		02	OFF → ON: Operation ON → OFF: Stop
		03	ON: Operation OFF: The system stops, then the applicable unit indicates A0 . The other indoor units indicate U9 .
		04	—
		05	—
		06	—
		07	Only for FBQ-TB ON: Economizer (field supply) is connected. OFF: Not connected

1.5.16 Thermostat Differential Changeover

Differential value during thermostat ON/OFF control can be changed.

Mode No.	First Code No.	Second Code No.	Contents
12 (22)	2	01	1.0°C (1.8°F)
		02	0.5°C (0.9°F)

Factory Setting

Model	Second Code No.	Contents
FCQ-TA, FHQ-P, FHQ-M, FTQ-TA	01	1.0°C (1.8°F)
FCQ-AA, FAQ-TA, FBQ-P, FBQ-TB	02	0.5°C (0.9°F)

1.5.17 Airflow Setting when Heating Thermostat is OFF

This setting is used to set airflow when heating thermostat is OFF.

* When thermostat OFF airflow volume up mode is used, careful consideration is required before deciding installation location.

★: Factory setting

Mode No.	First Code No.	Second Code No.	Contents
12 (22)	3	01★	LL tap★
		02	Set fan speed
		03	OFF

1.5.18 Automatic Mode Differential

This setting makes it possible to change differential values for mode selection while in automatic operation mode, only when the wireless remote controller or any central remote controller is connected.

★: Factory setting

Mode No.	First Code No.	Second Code No.							
		01★	02	03	04	05	06	07	08
12 (22)	4	0°C (0°F)★	1°C (1.8°F)	2°C (3.6°F)	3°C (5.4°F)	4°C (7.2°F)	5°C (9°F)	6°C (10.8°F)	7°C (12.6°F)

The automatic operation mode setting is made by the use of the "Operation Mode Selector" button.

1.5.19 Auto Restart after Power Failure

★: Factory setting

Mode No.	First Code No.	Second Code No.	Contents
12 (22)	5	01	OFF
		02★	ON★

When the "Auto Restart after Power Failure" setting is turned OFF, all the units will remain OFF after power failure, or after the main power supply is restored. When this setting is turned ON (factory setting), the units that were operating before the power failure will automatically restart operation after power failure, or after the main power supply is restored.

Due to the aforementioned, when the "Auto restart after power failure" setting is ON, be careful for the following situations that may occur.



Caution

1. The air conditioner will start operation suddenly after power failure, or when the main power supply is restored. The user might be surprised and wonder why the air conditioner turned ON suddenly.
2. During maintenance, if the main power supply is turned OFF while the units are in operation, the units will automatically start operation (the fan will rotate) after the power supply is restored due to completion of the maintenance work.

1.5.20 Airflow Setting when Cooling Thermostat is OFF

This is used to set airflow to LL airflow when cooling thermostat is OFF.

★: Factory setting

Mode No.	First Code No.	Second Code No.	Contents
12 (22)	6	01	LL tap
		02★	Set fan speed★
		03	OFF

1.5.21 Ceiling Height Setting, Setting of Normal Airflow

Make the following setting according to the ceiling height. The second code No. is set to **01** at the factory.

■ FCQ18/24TA, FCQ18/24AA

★: Factory setting

Mode No.	First Code No.	Second Code No.	Setting	Ceiling Height			
				All round outlet	4-way Outlets	3-way Outlets	2-way Outlets
13 (23)	0	01★	Standard★	Lower than 2.7 m★ (8-3/4 ft)	Lower than 3.1 m (10-1/8 ft)★	Lower than 3.0 m (10 ft)★	Lower than 3.5 m (11-1/2 ft)★
		02	High Ceiling (1)	Lower than 3.0 m (10 ft)	Lower than 3.4 m (11-1/8 ft)	Lower than 3.3 m (10-3/4 ft)	Lower than 3.8 m (12-1/2 ft)
		03	High Ceiling (2)	Lower than 3.5 m (11-1/2 ft)	Lower than 4.0 m (13-1/8 ft)	Lower than 3.5 m (11-1/2 ft)	—

■ FCQ30-48TA, FCQ30-48AA

★: Factory setting

Mode No.	First Code No.	Second Code No.	Setting	Ceiling Height			
				All round outlet	4-way Outlets	3-way Outlets	2-way Outlets
13 (23)	0	01★	Standard★	Lower than 3.2 m (10-1/2 ft)★	Lower than 3.4 m (11-1/8 ft)★	Lower than 3.6 m (12 ft)★	Lower than 4.2 m (13-3/4 ft)★
		02	High Ceiling (1)	Lower than 3.6 m (12 ft)	Lower than 3.9 m (12-3/4 ft)	Lower than 4.0 m (13-1/8 ft)	Lower than 4.2 m (13-3/4 ft)
		03	High Ceiling (2)	Lower than 4.2 m (13-3/4 ft)	Lower than 4.5 m (14-3/4 ft)	Lower than 4.2 m (13-3/4 ft)	—



Note(s)

- The Second Code No. is factory set to Standard/All-direction airflow. For High ceiling (1) or (2), initial setting by remote controller is required.
- A closing member kit (optional) is required for 4-, 3-, or 2-direction airflow.

■ FAQ-TA

★: Factory setting

Mode No.	First Code No.	Second Code No.	Contents
13 (23)	0	01★	Standard★
		02	A little increase
		03	Increase

1.5.22 Airflow Direction Setting

Set the airflow direction of indoor units as given in the table below. (Set when sealing material kit of air discharge outlet has been installed.) The second code No. is factory set to **01**.

★: Factory setting

Mode No.	First Code No.	Second Code No.	Contents
13 (23)	1	01★	4-direction airflow★
		02	3-direction airflow
		03	2-direction airflow

1.5.23 Swing Pattern Settings

(For units with an infrared floor sensor)

Set the flap operation in swing mode.

With the factory swing, flaps facing each other are synchronized to operate, and flaps placed side by side are set to swing in an opposite direction to agitate airflow to reduce temperature irregularity. Conventional swing operation (all direction synchronized swing) can be set onsite.

★: Factory setting

Mode No.	First Code No.	Second Code No.	Contents
13 (23)	2	01	All direction synchronized swing
		02	—
		03★	Facing swing★

1.5.24 Airflow Direction Adjustment Range

Make the following airflow direction setting according to the respective purpose.

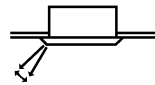

■ FCQ-TA, FCQ-AA, FAQ-TA

★: Factory setting

Mode No.	First Code No.	Second Code No.	Contents
13 (23)	4	01	Draft prevention (Upward)
		02★	Standard★
		03	Ceiling soiling prevention (Downward)



Note(s)

When the model FCQ-TA or FCQ-AA is attached with a closing member kit, set the Second Code No. to **02** or **03**.

1.5.25 External Static Pressure Settings

Make external static pressure setting automatically using automatic airflow adjustment, or manually using external static pressure settings.

■ FBQ-P, FBQ-TB

★: Factory setting

Mode No.	First Code No.	Second Code No.	Contents
13 (23)	6	02	50 Pa (0.20 inWG)
		03	60 Pa (0.24 inWG)
		04	70 Pa (0.28 inWG)
		05	80 Pa (0.32 inWG)
		06	90 Pa (0.36 inWG)
		07★	100 Pa (0.40 inWG)★
		08	110 Pa (0.44 inWG)
		09	120 Pa (0.48 inWG)
		10	130 Pa (0.52 inWG)
		11	140 Pa (0.56 inWG)
		12	150 Pa (0.60 inWG)
		13	160 Pa (0.64 inWG)
		14	180 Pa (0.72 inWG)
		15	200 Pa (0.80 inWG)

Make sure that 11 (21)-7 (Airflow adjustment) is set to **01** (OFF).

1.5.26 Optional Kit Setting (UV lamp + Humidifier + Economizer)

■ FTQ-TA

★: Factory setting

Mode No.	First Code No.	Second Code No.	Contents	
			UV lamp + humidifier fan speed	Economizer setting for Mech standby duration (minutes)
14 (24)	4	01	Refer to controller	10
		02	High	10
		03	Refer to controller	20
		04	High	20
		05	Refer to controller	30
		06	High	30
		07	Refer to controller	40
		08	High	40
		09	Refer to controller	50
		10	High	50
		11	Refer to controller	60
		12	High	60
		13	Refer to controller	Free cooling only
		14★	High★	Free cooling only★

1.5.27 Dry Mode Set Temperature (for FTQ-TA Models)

★: Factory setting

Mode No.	First Code No.	Second Code No.	Contents
14 (24)	5	01★	Room temperature★
		02	Same as cooling mode set temperature

1.5.28 Drain Pump Operation Settings

■ FBQ-P

The drain pump operation can be disabled for natural drainage by changing the following field setting.

★: Factory setting

Mode No.	First Code No.	Second Code No.	Contents
15 (25)	0	01	—
		02★	ON★
		03	OFF

1.5.29 Humidification when Heating Thermostat is OFF

Setting to **Equipped** turns ON the humidifier if suction air temperature is 20°C (68°F) or more and turns OFF the humidifier if suction air temperature is 18°C (64.4°F) or below when the heating thermostat is OFF.

★: Factory setting

Mode No.	First Code No.	Second Code No.	Contents
15 (25)	1	01★	Not equipped★
		02	Equipped

1.5.30 Direct Duct Connection

This is used when "fresh air intake kit equipped with fan" is connected. The indoor unit fan carries out residual operation for 1 minute after the thermostat is stopped. (For the purpose of preventing dust on the air filter from falling off.)

★: Factory setting

Mode No.	First Code No.	Second Code No.	Contents
15 (25)	2	01★	Not equipped★
		02	Equipped

1.5.31 Drain Pump and Humidifier Interlock Selection

This is used to interlock the humidifier with the drain pump. When water is drained out of the unit, this setting is unnecessary.

★: Factory setting

Mode No.	First Code No.	Second Code No.	Contents
15 (25)	3	01★	Not interlocked★
		02	Interlocked

1.5.32 Individual Ventilation Setting

This is set to perform individual operation of energy recovery ventilator using the remote controller/central unit when heat reclaim ventilation is built in.

(Switch only when heat reclaim ventilation is built in.)

★: Factory setting

Mode No.	First Code No.	Second Code No.	Contents
15 (25)	5	01★	Normal★
		02	Individual

1.5.33 Display of Error Codes on the Remote Controller

For BRC1E series only

Error code (four digits) is displayed for limited products.

Select two-digit display if four-digit display is not preferred.

★: Factory setting

Mode No.	First Code No.	Second Code No.	Contents
1b	4	01	—
		02	Two-digit display
		03	—
		04★	Four-digit display★

1.5.34 Room Temperature Display

For BRC1E series only

A "Detailed display screen" can be selected as the display screen. This setting is used if you do not want "Room temperature display" to be shown on the "Detailed display screen".

★: Factory setting

Mode No.	First Code No.	Second Code No.	Contents
1c	0	01	Room temperature is not displayed.
		02★	Room temperature is displayed.★

1.5.35 Thermistor Sensor for Auto Changeover and Setback Control by the Remote Controller

For BRC1E series only

Select a thermistor to utilize for the cool/heat mode automatic changeover and setback functions.
The sensed temperature will be displayed on the remote controller as the room temperature.

★: Factory setting

Mode No.	First Code No.	Second Code No.	Contents
1c	1	01	Utilize the return air thermistor
		<u>02</u>	<u>Utilize the remote controller thermistor★</u>

1.5.36 Access Permission Level Setting

For BRC1E series only

There are 2 levels as follows:

- Level 2: The following buttons are selectable to be disable or enable.
- Level 3: No buttons are selectable and only **On/Off** button is available.

Button	Level 2	Level 3
▲▼◀▶	Selectable (Enable)	Unselectable (Disable)
On/Off	Selectable (Enable)	Unselectable (Enable)
Mode	Selectable (Enable)	Unselectable (Disable)
Fan Speed	Selectable (Enable)	Unselectable (Disable)
Menu/OK	Unselectable (Disable)	Unselectable (Disable)
Cancel	Unselectable (Disable)	Unselectable (Disable)

() shows the factory setting

★: Factory setting

Mode No.	First Code No.	Second Code No.	Contents
1c	3	<u>01★</u>	<u>Level 2★</u>
		02	Level 3

1.5.37 Setback Availability

For BRC1E series only

Select the operation mode in which the setback function is available.

★: Factory setting

Mode No.	First Code No.	Second Code No.	Contents
1e	2	<u>01★</u>	<u>N/A★</u>
		02	Heat only
		03	Cool only
		04	Cool/heat

1.5.38 Setting Restricted/Permitted for Airflow Block

For Sensing flow type only

The airflow block function cannot be enabled when closure material kit, fresh air intake kit, separately installed natural evaporation type humidifier, or branch air duct is equipped, due to the possibility of dew condensation.

This setting restricts the airflow block function, preventing that the airflow block is inadvertently set to ON.

Ensure that "Airflow block restricted" is set when using the options listed above.

★: Factory setting

Mode No.	First Code No.	Second Code No.	Contents
1e	14	01★	Airflow block permitted★
		02	—
		03	—
		04	—
		05	Airflow block restricted

1.6 Operation Control Mode

The operation control mode is compatible with a variety of controls and operations by limiting the functions of the operation remote controller. Furthermore, operations such as remote controller ON/OFF can be limited in accordance with the combination conditions.

Centralized controller is normally available for operations. (Except when centralized monitor is connected)

Contents of Control Modes

20 modes consisting of combinations of the following 5 operation modes with temperature and operation mode setting by remote controller can be set and displayed by operation modes 0 through 19.

- ON/OFF control impossible by remote controller
Used when you want to turn ON/OFF by centralized remote controller only.
(Cannot be turned ON/OFF by remote controller.)
- OFF control only possible by remote controller
Used when you want to turn ON by centralized remote controller only, and OFF by remote controller only.
- Centralized
Used when you want to turn ON by centralized remote controller only, and turn ON/OFF freely by remote controller during set time.
- Individual
Used when you want to turn ON/OFF by both centralized remote controller and remote controller.
- Timer operation possible by remote controller
Used when you want to turn ON/OFF by remote controller during set time and you do not want to start operation by centralized remote controller when time of system start is programmed.

2. Field Settings from Outdoor Unit

2.1 Setting Mode and Monitor Mode

The following 3 modes can be changed over with the button switches on the PCB and you can find the present mode by the status of the H1P indicator.

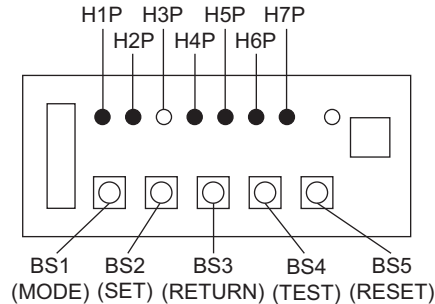

(1) Setting mode 1 (H1P OFF)

Initial status (normal) : Also indicates during abnormal.

(2) Setting mode 2 (H1P ON)

Used to modify the operating status and to set program addresses, etc. Usually used in servicing the system.

(3) Monitor mode (H1P blinks)

Used to check the program made in setting mode 2.

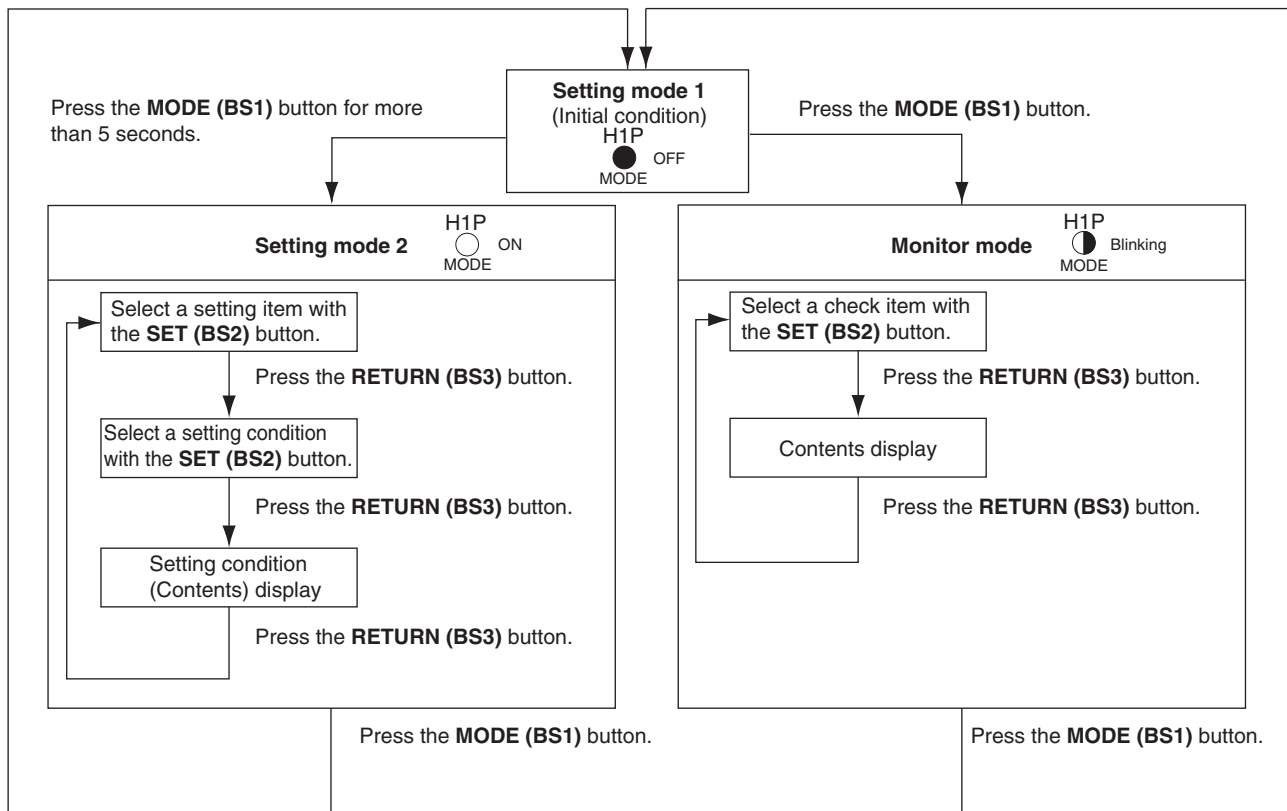

2.2 Setting Mode 1

This mode is used to set and check the following items.

1. Set items

In order to make COOL/HEAT selection in a batch of outdoor unit group, change the setting.

COOL/HEAT selection (IND)	Used to select COOL or HEAT by individual outdoor unit (factory setting).
COOL/HEAT selection (MASTER)	Used to select COOL or HEAT by outdoor unit group with the master unit.
COOL/HEAT selection (SLAVE)	Used to select COOL or HEAT by outdoor unit group with the slave unit.

2. Check items

The following items can be checked.

- (1) Current operating conditions (Normal / Abnormal / In check operation)
- (2) Setting conditions of COOL/HEAT selection (Individual / Batch master / Batch slave)
- (3) Low noise operating conditions (In normal operation / In low noise operation)
- (4) Demand operating conditions (In normal operation / In demand operation)

Procedure for changing COOL/HEAT selection setting

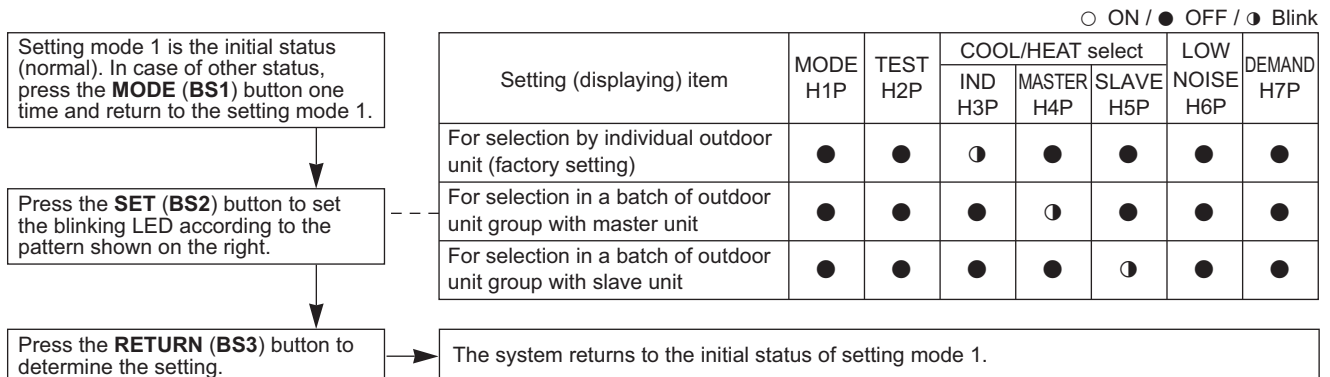

Procedure for checking

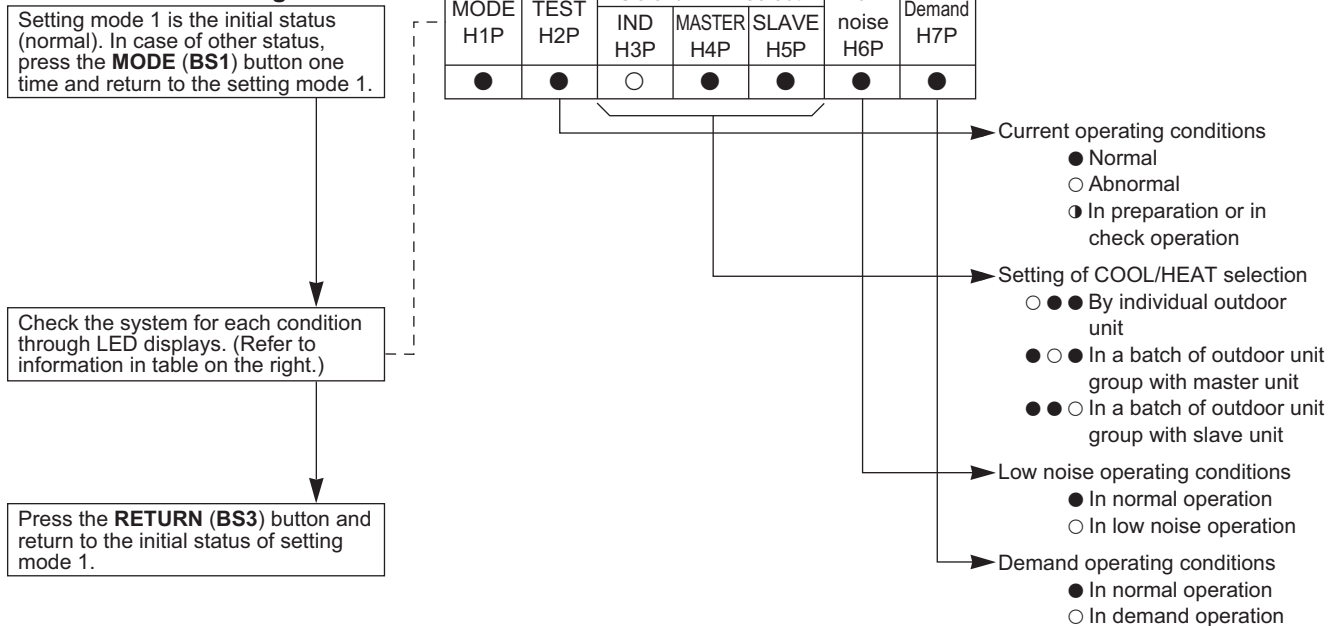

2.3 Setting Mode 2

Press the **MODE (BS1)** button for 5 seconds and enter the setting mode 2.

Selection of setting items

Press the **SET (BS2)** button and select a setting item according to the LED pattern shown in the table on the right.

Press the **RETURN (BS3)** button and decide the item. (The present setting condition is shown.)

Selection of setting conditions

Press the **SET (BS2)** button and select to the setting condition you want.

Press the **RETURN (BS3)** button and decide the condition.

Press the **RETURN (BS3)** button and return to the initial status of setting mode 2.

* If you become unsure of how to proceed, press the **MODE (BS1)** button and return to the setting mode 1.

No.	Setting item	Description
1	Cool / heat unified address	Sets address for cool / heat unified operation.
2	Low noise / demand address	Address for low noise / demand operation
3	Test operation settings	Used to conduct test operation without making changes to the PCB and replacing the refrigerant, after the completion of maintenance
5	Indoor unit forced fan H	Allows forced operation of indoor fan while unit is stopped. (H tap)
6	Indoor unit forced operation	Allows forced operation of indoor unit.
8	Te setting	Target evaporation temperature for cooling
9	Tc setting	Target condensation temperature for heating
10	Defrost changeover setting	Changes the temperature condition for defrost and sets to earlier start defrost or later start defrost.
11 (*1)	TeS upper limit setting	Target evaporation temperature upper limit for cooling
12	External low noise / demand setting	Reception of external low noise or demand signal
13	AIRNET address	Set address for AIRNET.
16	Setting of heat pump lockout 1	Make this setting for heat pump lockout.
19	Emergency automatic heat pump lockout	Heat pump is automatically locked out in the event of a system failure.
20	Additional refrigerant charge operation setting	Carries out additional refrigerant charge operation.
21	Refrigerant recovery / vacuuming mode setting	Sets to refrigerant recovery or vacuuming mode.
22	Night-time low noise setting	Sets automatic nighttime low noise operation in a simple way. The operating time is based on Starting Set and Ending Set.
25	Setting of low noise level	Sets low noise level when the low noise signal is received.
26	Night-time low noise operation start setting	Sets starting time of nighttime low noise operation. (Night-time low noise setting is also required.)
27	Night-time low noise operation end setting	Sets ending time of nighttime low noise operation. (Night-time low noise setting is also required.)
28	Power transistor check mode *Check after disconnection of compressor wires	Used for trouble diagnosis of DC compressor. Since the waveform of inverter is output without wiring to the compressor, it is convenient to probe whether the trouble comes from the compressor or PCB.
29	Capacity precedence setting	If the capacity control is required, the low noise control is automatically released by this setting during carrying out low noise operation and night-time low noise operation.
30	Demand setting 1	Changes target value of power consumption when demand control 1 is received.
32	Constant demand setting	Enables demand control 1 without external input.
37	Setting of heat pump lockout 2	Make this setting for heat pump lockout.
41	Cooling comfort setting	Selects comfort level of VRT cooling.
42	Heating comfort setting	Selects comfort level of VRT heating.
47	Heat pump lockout release differential	Heat pump would be resumed when the outdoor air temperature is recovered by differential above the heat pump lockout temperature.
50	Auxiliary heater maximum allowable temperature	Auxiliary heater is allowed to energize when the outdoor air temperature is smaller than the auxiliary heater maximum allowable temperature.
54 (*2)	TcS lower limit setting	Target condensation temperature lower limit for heating
56	Auxiliary heater maximum allowable temperature release differential	Auxiliary heater is not allowed to energize when the outdoor air temperature is recovered by differential above the auxiliary heater maximum allowable temperature.
57	Heat pump lockout temperature	Heat pump would be locked out when the outdoor air temperature is smaller than the heat pump lockout temperature. This setting is only effective when heat pump lockout mode has been set.

The numbers in the No. column represent the number of times to press the **SET (BS2)** button

*1. For RZR30-48TB, RZQ30-48TB models only

*2. For RZQ30-48TB models only

No.	Setting item display								Setting condition display			
	Setting item	MODE H1P	TEST H2P	C/H selection			Low noise H6P	Demand H7P				* Factory setting
				IND H3P	Master H4P	Slave H5P						
1	Cool / heat unified address	<input type="radio"/>	<input checked="" type="radio"/>	<input checked="" type="radio"/>	<input checked="" type="radio"/>	<input checked="" type="radio"/>	<input checked="" type="radio"/>	<input type="radio"/>	Address	0	<input type="radio"/>	*
									Binary number (6 digits)	1	<input type="radio"/>	*
									~	31	<input type="radio"/>	
2	Low noise / demand address	<input type="radio"/>	<input checked="" type="radio"/>	<input checked="" type="radio"/>	<input checked="" type="radio"/>	<input checked="" type="radio"/>	<input type="radio"/>	<input checked="" type="radio"/>	Address	0	<input type="radio"/>	*
									Binary number (6 digits)	1	<input type="radio"/>	*
									~	31	<input type="radio"/>	
3	Test operation settings	<input type="radio"/>	<input checked="" type="radio"/>	<input checked="" type="radio"/>	<input checked="" type="radio"/>	<input checked="" type="radio"/>	<input type="radio"/>	<input type="radio"/>	Test operation : OFF		<input type="radio"/>	
									Test operation : ON		<input type="radio"/>	*
5	Indoor unit forced fan H	<input type="radio"/>	<input checked="" type="radio"/>	<input checked="" type="radio"/>	<input checked="" type="radio"/>	<input type="radio"/>	<input checked="" type="radio"/>	<input type="radio"/>	Normal operation		<input type="radio"/>	*
									Indoor forced fan H		<input type="radio"/>	*
6	Indoor unit forced operation	<input type="radio"/>	<input checked="" type="radio"/>	<input checked="" type="radio"/>	<input checked="" type="radio"/>	<input type="radio"/>	<input type="radio"/>	<input checked="" type="radio"/>	Normal operation		<input type="radio"/>	*
									Indoor forced operation		<input type="radio"/>	*
8	Te setting	<input type="radio"/>	<input checked="" type="radio"/>	<input checked="" type="radio"/>	<input type="radio"/>	<input checked="" type="radio"/>	<input checked="" type="radio"/>	<input checked="" type="radio"/>	Target Te: 11°C (51.8°F)		<input type="radio"/>	
									10°C (50°F)		<input type="radio"/>	*
									9°C (48.2°F)		<input type="radio"/>	
									8°C (46.4°F)		<input type="radio"/>	
									Variable (VRT)		<input type="radio"/>	*
									6°C (42.8°F)		<input type="radio"/>	
9	Tc setting	<input type="radio"/>	<input checked="" type="radio"/>	<input checked="" type="radio"/>	<input type="radio"/>	<input checked="" type="radio"/>	<input checked="" type="radio"/>	<input type="radio"/>	Target Tc: 52°C (125.6°F)		<input type="radio"/>	
									46°C (114.8°F)		<input type="radio"/>	*
									Variable (VRT)		<input type="radio"/>	
10	Defrost changeover setting	<input type="radio"/>	<input checked="" type="radio"/>	<input checked="" type="radio"/>	<input type="radio"/>	<input checked="" type="radio"/>	<input type="radio"/>	<input checked="" type="radio"/>	Earlier start defrost		<input type="radio"/>	
									Normal (factory setting)		<input type="radio"/>	*
									Later start defrost		<input type="radio"/>	
11 (*1)	TeS upper limit setting	<input type="radio"/>	<input checked="" type="radio"/>	<input checked="" type="radio"/>	<input type="radio"/>	<input checked="" type="radio"/>	<input type="radio"/>	<input type="radio"/>	L		<input type="radio"/>	
									M		<input type="radio"/>	*
									H		<input type="radio"/>	
12	External low noise / demand setting	<input type="radio"/>	<input checked="" type="radio"/>	<input checked="" type="radio"/>	<input type="radio"/>	<input type="radio"/>	<input checked="" type="radio"/>	<input checked="" type="radio"/>	External low noise/demand: NO		<input type="radio"/>	*
									External low noise/demand: YES		<input type="radio"/>	
13	AIRNET address	<input type="radio"/>	<input checked="" type="radio"/>	<input checked="" type="radio"/>	<input type="radio"/>	<input type="radio"/>	<input checked="" type="radio"/>	<input type="radio"/>	Address	0	<input type="radio"/>	*
									Binary number (6 digits)	1	<input type="radio"/>	*
									~	63	<input type="radio"/>	
16	Setting of heat pump lockout 1	<input type="radio"/>	<input checked="" type="radio"/>	<input type="radio"/>	<input checked="" type="radio"/>	<input checked="" type="radio"/>	<input checked="" type="radio"/>	<input checked="" type="radio"/>	OFF		<input type="radio"/>	*
									ON		<input type="radio"/>	*
19	Emergency automatic heat pump lockout	<input type="radio"/>	<input checked="" type="radio"/>	<input type="radio"/>	<input checked="" type="radio"/>	<input checked="" type="radio"/>	<input type="radio"/>	<input type="radio"/>	OFF		<input type="radio"/>	
									ON		<input type="radio"/>	*
20	Additional refrigerant charge operation setting	<input type="radio"/>	<input checked="" type="radio"/>	<input type="radio"/>	<input checked="" type="radio"/>	<input type="radio"/>	<input checked="" type="radio"/>	<input checked="" type="radio"/>	Refrigerant charging: OFF		<input type="radio"/>	*
									Refrigerant charging: ON		<input type="radio"/>	*
21	Refrigerant recovery / vacuuming mode setting	<input type="radio"/>	<input checked="" type="radio"/>	<input type="radio"/>	<input checked="" type="radio"/>	<input type="radio"/>	<input checked="" type="radio"/>	<input type="radio"/>	Refrigerant recovery / vacuuming: OFF		<input type="radio"/>	*
									Refrigerant recovery / vacuuming: ON		<input type="radio"/>	*

The numbers in the No. column represent the number of times to press the SET (BS2) button.

*1. For RZR30-48TB, RZQ30-48TB models only

No.	Setting item display							Setting condition display	
	Setting item	MODE H1P	TEST H2P	C/H selection			Low noise H6P		
				IND H3P	Master H4P	Slave H5P			
22	Night-time low noise setting	<input type="radio"/>	<input checked="" type="radio"/>	<input type="radio"/>	<input checked="" type="radio"/>	<input type="radio"/>	<input type="radio"/>	<input checked="" type="radio"/>	OFF <input type="radio"/> <input checked="" type="radio"/> <input checked="" type="radio"/> <input checked="" type="radio"/> <input checked="" type="radio"/> <input checked="" type="radio"/> <input checked="" type="radio"/> * Level 1 (outdoor fan with 6 step or lower) <input type="radio"/> <input checked="" type="radio"/> <input checked="" type="radio"/> <input checked="" type="radio"/> <input checked="" type="radio"/> <input checked="" type="radio"/> <input type="radio"/> Level 2 (outdoor fan with 5 step or lower) <input type="radio"/> <input checked="" type="radio"/> <input checked="" type="radio"/> <input checked="" type="radio"/> <input checked="" type="radio"/> <input type="radio"/> <input checked="" type="radio"/> Level 3 (outdoor fan with 4 step or lower) <input type="radio"/> <input checked="" type="radio"/> <input checked="" type="radio"/> <input checked="" type="radio"/> <input type="radio"/> <input type="radio"/> <input type="radio"/>
25	Setting of low noise level	<input type="radio"/>	<input checked="" type="radio"/>	<input type="radio"/>	<input type="radio"/>	<input checked="" type="radio"/>	<input checked="" type="radio"/>	<input type="radio"/>	Level 1 (outdoor fan with 6 step or lower) <input type="radio"/> <input checked="" type="radio"/> <input checked="" type="radio"/> <input checked="" type="radio"/> <input checked="" type="radio"/> <input checked="" type="radio"/> <input type="radio"/> Level 2 (outdoor fan with 5 step or lower) <input type="radio"/> <input checked="" type="radio"/> <input checked="" type="radio"/> <input checked="" type="radio"/> <input type="radio"/> <input checked="" type="radio"/> <input checked="" type="radio"/> * Level 3 (outdoor fan with 4 step or lower) <input type="radio"/> <input checked="" type="radio"/> <input checked="" type="radio"/> <input type="radio"/> <input checked="" type="radio"/> <input checked="" type="radio"/> <input checked="" type="radio"/>
26	Night-time low noise operation start setting	<input type="radio"/>	<input checked="" type="radio"/>	<input type="radio"/>	<input type="radio"/>	<input checked="" type="radio"/>	<input type="radio"/>	<input checked="" type="radio"/>	About 8:00 PM <input type="radio"/> <input checked="" type="radio"/> <input checked="" type="radio"/> <input checked="" type="radio"/> <input checked="" type="radio"/> <input type="radio"/> <input type="radio"/> About 10:00 PM (factory setting) <input type="radio"/> <input checked="" type="radio"/> <input checked="" type="radio"/> <input checked="" type="radio"/> <input type="radio"/> <input checked="" type="radio"/> <input checked="" type="radio"/> * About 12:00 AM <input type="radio"/> <input checked="" type="radio"/> <input checked="" type="radio"/> <input type="radio"/> <input checked="" type="radio"/> <input checked="" type="radio"/> <input checked="" type="radio"/>
27	Night-time low noise operation end setting	<input type="radio"/>	<input checked="" type="radio"/>	<input type="radio"/>	<input type="radio"/>	<input checked="" type="radio"/>	<input type="radio"/>	<input type="radio"/>	About 6:00 AM <input type="radio"/> <input checked="" type="radio"/> <input checked="" type="radio"/> <input checked="" type="radio"/> <input checked="" type="radio"/> <input type="radio"/> <input type="radio"/> About 7:00 AM <input type="radio"/> <input checked="" type="radio"/> <input checked="" type="radio"/> <input checked="" type="radio"/> <input type="radio"/> <input checked="" type="radio"/> <input checked="" type="radio"/> About 8:00 AM (factory setting) <input type="radio"/> <input checked="" type="radio"/> <input checked="" type="radio"/> <input type="radio"/> <input checked="" type="radio"/> <input checked="" type="radio"/> <input checked="" type="radio"/> *
28	Power transistor check mode	<input type="radio"/>	<input checked="" type="radio"/>	<input type="radio"/>	<input type="radio"/>	<input type="radio"/>	<input checked="" type="radio"/>	<input checked="" type="radio"/>	OFF <input type="radio"/> <input checked="" type="radio"/> <input checked="" type="radio"/> <input checked="" type="radio"/> <input checked="" type="radio"/> <input type="radio"/> <input type="radio"/> * ON <input type="radio"/> <input checked="" type="radio"/> <input checked="" type="radio"/> <input checked="" type="radio"/> <input type="radio"/> <input checked="" type="radio"/> <input checked="" type="radio"/>
29	Capacity precedence setting	<input type="radio"/>	<input checked="" type="radio"/>	<input type="radio"/>	<input type="radio"/>	<input type="radio"/>	<input checked="" type="radio"/>	<input type="radio"/>	OFF <input type="radio"/> <input checked="" type="radio"/> <input checked="" type="radio"/> <input checked="" type="radio"/> <input checked="" type="radio"/> <input type="radio"/> <input type="radio"/> * ON <input type="radio"/> <input checked="" type="radio"/> <input checked="" type="radio"/> <input type="radio"/> <input checked="" type="radio"/> <input checked="" type="radio"/> <input checked="" type="radio"/>
30	Demand setting 1	<input type="radio"/>	<input checked="" type="radio"/>	<input type="radio"/>	<input type="radio"/>	<input type="radio"/>	<input type="radio"/>	<input checked="" type="radio"/>	60 % demand <input type="radio"/> <input checked="" type="radio"/> <input checked="" type="radio"/> <input checked="" type="radio"/> <input checked="" type="radio"/> <input type="radio"/> <input type="radio"/> 70 % demand <input type="radio"/> <input checked="" type="radio"/> <input checked="" type="radio"/> <input checked="" type="radio"/> <input type="radio"/> <input checked="" type="radio"/> <input checked="" type="radio"/> * 80 % demand <input type="radio"/> <input checked="" type="radio"/> <input checked="" type="radio"/> <input type="radio"/> <input checked="" type="radio"/> <input checked="" type="radio"/> <input checked="" type="radio"/>
32	Constant demand setting	<input type="radio"/>	<input type="radio"/>	<input checked="" type="radio"/>	<input checked="" type="radio"/>	<input checked="" type="radio"/>	<input checked="" type="radio"/>	<input checked="" type="radio"/>	OFF <input type="radio"/> <input checked="" type="radio"/> <input checked="" type="radio"/> <input checked="" type="radio"/> <input checked="" type="radio"/> <input type="radio"/> <input type="radio"/> * ON <input type="radio"/> <input checked="" type="radio"/> <input checked="" type="radio"/> <input checked="" type="radio"/> <input type="radio"/> <input checked="" type="radio"/> <input checked="" type="radio"/>
37	Setting of heat pump lockout 2	<input type="radio"/>	<input type="radio"/>	<input checked="" type="radio"/>	<input checked="" type="radio"/>	<input type="radio"/>	<input checked="" type="radio"/>	<input type="radio"/>	OFF <input type="radio"/> <input checked="" type="radio"/> <input checked="" type="radio"/> <input checked="" type="radio"/> <input checked="" type="radio"/> <input checked="" type="radio"/> <input checked="" type="radio"/> * Mode 1 <input type="radio"/> <input checked="" type="radio"/> <input checked="" type="radio"/> <input checked="" type="radio"/> <input checked="" type="radio"/> <input type="radio"/> <input type="radio"/> Mode 2 <input type="radio"/> <input checked="" type="radio"/> <input checked="" type="radio"/> <input checked="" type="radio"/> <input type="radio"/> <input checked="" type="radio"/> <input checked="" type="radio"/> Mode 3 <input type="radio"/> <input checked="" type="radio"/> <input checked="" type="radio"/> <input checked="" type="radio"/> <input type="radio"/> <input checked="" type="radio"/> <input type="radio"/> Mode 4 <input type="radio"/> <input checked="" type="radio"/> <input checked="" type="radio"/> <input type="radio"/> <input checked="" type="radio"/> <input checked="" type="radio"/> <input checked="" type="radio"/> Mode 5 <input type="radio"/> <input checked="" type="radio"/> <input checked="" type="radio"/> <input type="radio"/> <input checked="" type="radio"/> <input type="radio"/> <input checked="" type="radio"/> Mode 6 <input type="radio"/> <input checked="" type="radio"/> <input checked="" type="radio"/> <input type="radio"/> <input type="radio"/> <input checked="" type="radio"/> <input checked="" type="radio"/>
41	Cooling comfort setting	<input type="radio"/>	<input type="radio"/>	<input checked="" type="radio"/>	<input type="radio"/>	<input checked="" type="radio"/>	<input checked="" type="radio"/>	<input type="radio"/>	Eco <input type="radio"/> <input checked="" type="radio"/> <input checked="" type="radio"/> <input checked="" type="radio"/> <input checked="" type="radio"/> <input checked="" type="radio"/> <input checked="" type="radio"/> * Mild <input type="radio"/> <input checked="" type="radio"/> <input checked="" type="radio"/> <input checked="" type="radio"/> <input checked="" type="radio"/> <input type="radio"/> <input checked="" type="radio"/> Quick <input type="radio"/> <input checked="" type="radio"/> <input checked="" type="radio"/> <input checked="" type="radio"/> <input type="radio"/> <input checked="" type="radio"/> <input checked="" type="radio"/> Powerful <input type="radio"/> <input checked="" type="radio"/> <input checked="" type="radio"/> <input type="radio"/> <input checked="" type="radio"/> <input checked="" type="radio"/> <input type="radio"/>
42	Heating comfort setting	<input type="radio"/>	<input type="radio"/>	<input checked="" type="radio"/>	<input type="radio"/>	<input checked="" type="radio"/>	<input type="radio"/>	<input checked="" type="radio"/>	Eco <input type="radio"/> <input checked="" type="radio"/> <input checked="" type="radio"/> <input checked="" type="radio"/> <input checked="" type="radio"/> <input checked="" type="radio"/> <input checked="" type="radio"/> * Mild <input type="radio"/> <input checked="" type="radio"/> <input checked="" type="radio"/> <input checked="" type="radio"/> <input checked="" type="radio"/> <input type="radio"/> <input checked="" type="radio"/> Quick <input type="radio"/> <input checked="" type="radio"/> <input checked="" type="radio"/> <input checked="" type="radio"/> <input type="radio"/> <input checked="" type="radio"/> <input checked="" type="radio"/> Powerful <input type="radio"/> <input checked="" type="radio"/> <input checked="" type="radio"/> <input type="radio"/> <input checked="" type="radio"/> <input checked="" type="radio"/> <input type="radio"/>
47	Heat pump lockout release differential	<input type="radio"/>	<input type="radio"/>	<input checked="" type="radio"/>	<input type="radio"/>	<input type="radio"/>	<input type="radio"/>	<input type="radio"/>	2.8°C (5°F) <input type="radio"/> <input checked="" type="radio"/> <input checked="" type="radio"/> <input checked="" type="radio"/> <input checked="" type="radio"/> <input checked="" type="radio"/> <input checked="" type="radio"/> * 5.6°C (10°F) <input type="radio"/> <input checked="" type="radio"/> <input checked="" type="radio"/> <input checked="" type="radio"/> <input checked="" type="radio"/> <input type="radio"/> <input checked="" type="radio"/> 8.3°C (15°F) <input type="radio"/> <input checked="" type="radio"/> <input checked="" type="radio"/> <input checked="" type="radio"/> <input type="radio"/> <input checked="" type="radio"/> <input checked="" type="radio"/>

The numbers in the No. column represent the number of times to press the **SET (BS2)** button.

No.	Setting item display							Setting condition display		
	Setting item	MODE H1P	TEST H2P	C/H selection			Low noise H6P		Demand H7P	
IND H3P				Master H4P	Slave H5P					* Factory setting
50	Auxiliary heater maximum allowable temperature	○	○	○	●	●	○	●	-17.7°C (0°F)	○ ● ● ● ● ● ● ● ●
									-15°C (5°F)	○ ● ● ● ● ● ● ● ○
									-12.2°C (10°F)	○ ● ● ● ● ● ● ○ ●
									-9.4°C (15°F)	○ ● ● ● ● ● ○ ○
									-6.6°C (20°F)	○ ● ● ● ● ○ ● ●
									-3.8°C (25°F)	○ ● ● ● ● ○ ● ○
									-1.1°C (30°F)	○ ● ● ● ● ○ ○ ●
									1.6°C (35°F)	○ ● ● ● ● ○ ○ ○ *
									4.4°C (40°F)	○ ● ● ● ○ ● ● ●
									7.2°C (45°F)	○ ● ● ● ○ ● ● ○
									10°C (50°F)	○ ● ● ● ○ ● ○ ●
									12.7°C (55°F)	○ ● ● ● ○ ● ○ ○
									15.5°C (60°F)	○ ● ● ● ○ ○ ● ●
									18.3°C (65°F)	○ ● ● ● ○ ○ ● ○
Auxiliary heater always not allowed									○ ● ● ● ○ ○ ○ ●	
Auxiliary heater always allowed									○ ● ● ● ○ ○ ○ ○	
54 (*1)	TcS lower limit setting	○	○	○	●	○	○	●	LL	○ ● ● ● ● ● ● ○
									L	○ ● ● ● ● ● ● ●
									M	○ ● ● ● ● ○ ● ● *
									H	○ ● ● ● ○ ● ● ●
56	Auxiliary heater maximum allowable temperature release differential	○	○	○	○	●	●	●	2.8°C (5°F)	○ ● ● ● ● ● ● ●
									5.6°C (10°F)	○ ● ● ● ● ● ● ○ *
									8.3°C (15°F)	○ ● ● ● ● ● ○ ●
57	Heat pump lockout temperature	○	○	○	○	●	●	○	-26.1°C (-15°F)	○ ● ● ● ● ● ● ● *
									-23.3°C (-10°F)	○ ● ● ● ● ● ● ○
									-20.5°C (-5°F)	○ ● ● ● ● ● ○ ●
									-17.7°C (0°F)	○ ● ● ● ● ● ○ ○
									-15°C (5°F)	○ ● ● ● ● ○ ● ●
									-12.2°C (10°F)	○ ● ● ● ● ○ ● ○
									-9.4°C (15°F)	○ ● ● ● ● ○ ○ ●
									-6.6°C (20°F)	○ ● ● ● ● ○ ○ ○
									-3.8°C (25°F)	○ ● ● ● ○ ● ● ●
									-1.1°C (30°F)	○ ● ● ● ○ ● ● ○
									1.6°C (35°F)	○ ● ● ● ○ ● ○ ●
									4.4°C (40°F)	○ ● ● ● ○ ● ○ ○
									7.2°C (45°F)	○ ● ● ● ○ ○ ● ●
									10°C (50°F)	○ ● ● ● ○ ○ ● ○
Forced heat pump lockout									○ ● ● ● ○ ○ ○ ●	

The numbers in the No. column represent the number of times to press the **SET (BS2)** button.

*1. For RZQ30-48TB models only

2.4 Monitor Mode

Press the **MODE (BS1)** button and enter the monitor mode.

Selection of check item

Press the **SET (BS2)** button and select a check item according to the LED pattern.

Confirmation on check item

Press the **RETURN (BS3)** button to display different data of check item.

Press the **RETURN (BS3)** button and return to the initial status of monitor mode.

No.	Setting item	LED display							Data display
		H1P	H2P	H3P	H4P	H5P	H6P	H7P	
0	Various setting	●	●	●	●	●	●	●	See the note below.
1	Cool / heat unified address	●	●	●	●	●	●	○	Lower 6 digits
2	Low noise / demand address	●	●	●	●	●	○	●	
3	Not used	●	●	●	●	●	○	○	
4	AIRNET address	●	●	●	●	○	●	●	
5	Number of connected indoor units	●	●	●	●	○	●	○	
7	Number of connected zone units (excluding outdoor and BS unit)	●	●	●	●	○	○	○	
8	Number of outdoor units	●	●	●	○	●	●	●	Lower 6 digits
11	Number of zone units (excluding outdoor and BS unit)	●	●	●	○	●	○	○	
12	Number of terminal blocks	●	●	●	○	○	●	●	Lower 4 digits: upper
13	Number of terminal blocks	●	●	●	○	○	●	○	Lower 4 digits: lower
14	Error description (the latest)	●	●	●	○	○	○	●	Refer to the error code table on Part 6.
15	Error description (1 cycle before)	●	●	●	○	○	○	○	
16	Error description (2 cycle before)	●	●	○	●	●	●	●	
20	Contents of retry (the latest)	●	●	○	●	○	●	●	
21	Contents of retry (1 cycle before)	●	●	○	●	○	●	○	
22	Contents of retry (2 cycle before)	●	●	○	●	○	○	●	
25	Normal judgment of outdoor units PCB	●	●	○	○	●	●	○	Lower 2 digits: ○● Abnormal ●○ Normal ●● Unjudgment

* If you become unsure of how to proceed, press the **MODE (BS1)** button and return to the setting mode 1.

The numbers in the No. column represent the number of times to press the **SET (BS2)** button.



Note(s) Various Settings

		H1P	H2P	H3P	H4P	H5P	H6P	H7P
Emergency operation / backup operation setting	ON	●	●	●	○	●	●	●
	OFF	●	●	●	●	●	●	●
Defrost select setting	Short	●	●	●	●	○	●	●
	Medium	●	●	●	●	●	●	●
	Long	●	●	●	●	●	●	●
Te setting	H	●	●	●	●	●	○	●
	M	●	●	●	●	●	●	●
	L	●	●	●	●	●	●	●
Tc setting	H	●	●	●	●	●	●	○
	M	●	●	●	●	●	●	●
	L	●	●	●	●	●	●	●

Press the **SET (BS2)** button and match with the LEDs No. 1 - 15, push the **RETURN (BS3)** button, and confirm the data for each setting.

★ Data such as addresses and number of units is expressed as binary numbers; the two ways of expressing are as follows:

Figure 1

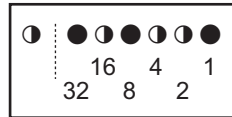

The No. 1 cool / heat unified address is expressed as a binary number consisting of the lower 6 digits. (0 - 63)

In the figure 1, the address is 010110 (binary number), which translates to $16 + 4 + 2 = 22$ (base 10 number). In other words, the address is 22.

Figure 2

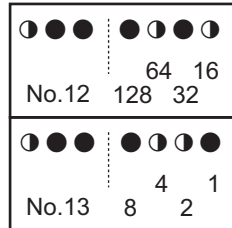

The number of terminal blocks for No. 12 and 13 is expressed as an 8-digit binary number, which is the combination of four upper, and four lower digits for No. 12 and 13 respectively. (0 - 128)

In the figure 2, the address for No. 12 is 0101, the address for No. 13 is 0110, and the combination of the two is 01010110 (binary number), which translates to $64 + 16 + 4 + 2 = 86$ (base 10 number). In other words, the number of terminal block is 86.

*Refer to the preceding page for a list of data, etc. for No. 0 - 25.

2.5 Setting of Low Noise Operation and Demand Operation

Setting of Low Noise Operation

By connecting the external contact input to the low noise input of the external control adaptor for outdoor unit (optional), you can lower operating noise by 2-3 dB.

When the low noise operation is automatically carried out at night (The external control adaptor for outdoor unit is not required)

1. While in setting mode 2, select the setting condition (i.e., Mode 1, Mode 2, or Mode 3) for set item No. 22 (Setting of night-time low noise level).
2. If necessary, while in setting mode 2, select the setting condition (i.e., 8:00 PM, 10:00 PM, or 12:00 AM) for set item No. 26 (Setting of start time of night-time low noise operation).
(Use the start time as a guide since it is estimated according to outdoor temperatures.)
3. If necessary, while in setting mode 2, select the setting condition (i.e., 06:00 AM, 07:00 AM, or 08:00 AM) for set item No. 27 (Setting of end time of night-time low noise operation).
(Use the end time as a guide since it is estimated according to outdoor temperatures.)
4. If necessary, while in setting mode 2, set the setting condition for set item No. 29 (Setting of capacity precedence) to ON.
(If the condition is set to ON, when the air-conditioning load reaches a high level, the system enters to normal operation mode even during night-time.)

Image of operation

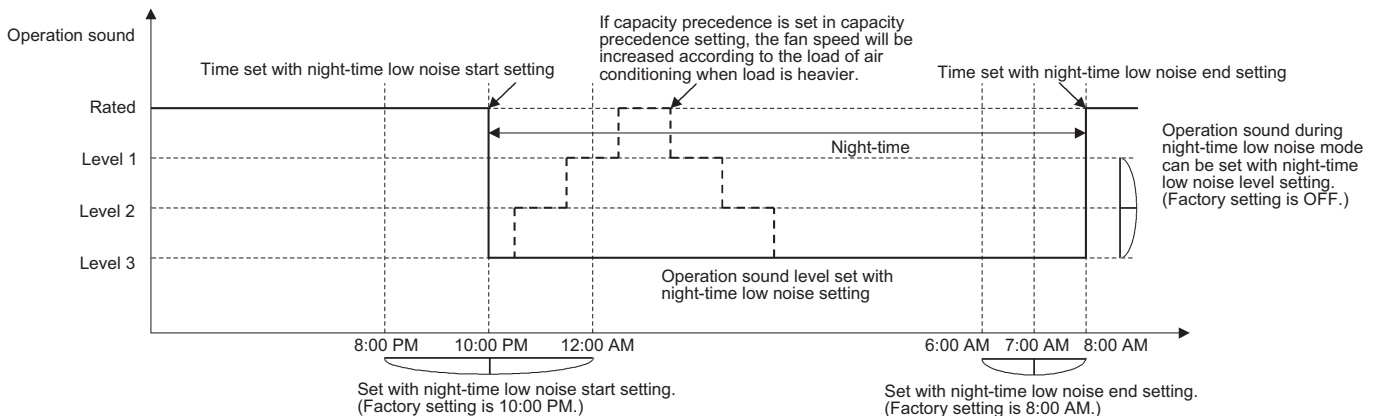

Setting of Demand Operation

By connecting the external contact input to the demand input of the external control adaptor for outdoor unit (optional), the power consumption of unit operation can be saved suppressing the compressor operating condition.

Set item	Condition	Content
Demand	Mode 1	The compressor operates at 60% or less of rating.
	Mode 2	The compressor operates at 70% or less of rating.
	Mode 3	The compressor operates at 80% or less of rating.

When the constant demand operation is carried out. (Use of the external control adaptor for outdoor unit is not required.)

1. While in setting mode 2, make setting of the set item No. 32 (Setting of constant demand) to ON.
2. While in setting mode 2, select the set item No. 30 (Setting of Demand 1 level) and then set the setting condition to targeted mode.

Image of operation

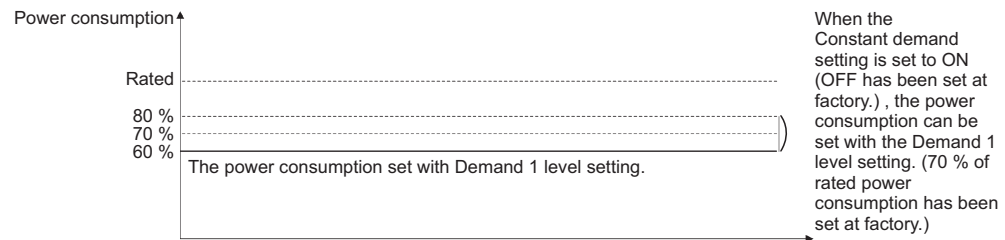

Detailed Setting Procedure of Low Noise Operation and Demand Control

1. Setting mode 1 (H1P OFF)

In setting mode 2, push the **MODE (BS1)** button one time. → The system enters setting mode 1 and the H1P goes off.

In setting mode 1, the H6P (In low noise operation) and the H7P (In demand control) keep lighting.

2. Setting mode 2 (H1P ON)

- (1) In setting mode 1, push and hold the **MODE (BS1)** button for more than 5 seconds. → The system enters setting mode 2 and the H1P lights up.
- (2) Push the **SET (BS2)** button several times and match the LED display with the Setting No. you want.
- (3) Push the **RETURN (BS3)** button one time, and the present setting content is displayed. → Push the **SET (BS2)** button several times and match the LED display with the setting content (as shown on next page) you want.
- (4) Push the **RETURN (BS3)** button two times. → The system returns to (1).
- (5) Push the **MODE (BS1)** button one time. → The system returns to setting mode 1 and the H1P goes OFF.

○: ON ●: OFF ◐: Blink

Setting No.	Setting contents	(1) Setting No. indication							(2) Setting No. indication							Setting contents	(3) Setting contents indication (Initial setting)														
		H1P	H2P	H3P	H4P	H5P	H6P	H7P	H1P	H2P	H3P	H4P	H5P	H6P	H7P		H1P	H2P	H3P	H4P	H5P	H6P	H7P								
12	External low noise / demand setting	<div style="background-color: #cccccc; width: 100%; height: 10px;"></div>							<div style="background-color: #cccccc; width: 100%; height: 10px;"></div>							NO (Factory setting)	○	●	●	●	●	●	●	○	●	●	●	●	●	◐	
																YES	○	●	●	●	●	◐	●	○	●	●	●	●	●	●	
22	Night-time low noise setting	<div style="background-color: #cccccc; width: 100%; height: 10px;"></div>							<div style="background-color: #cccccc; width: 100%; height: 10px;"></div>							OFF (Factory setting)	○	●	●	●	●	●	●	○	●	●	●	●	●	●	
																Level 1	○	●	●	●	●	●	◐	○	●	●	●	●	●	●	
																Level 2	○	●	●	●	●	●	◐	●	○	●	●	●	●	●	●
																Level 3	○	●	●	●	●	●	◐	◐	○	●	●	●	●	●	●
26	Night-time low noise operation start setting	<div style="background-color: #cccccc; width: 100%; height: 10px;"></div>							<div style="background-color: #cccccc; width: 100%; height: 10px;"></div>							8:00 PM	○	●	●	●	●	●	◐	○	●	●	●	●	●	◐	
																10:00 PM (Factory setting)	○	●	●	●	●	●	◐	●	○	●	●	●	●	●	●
																12:00 AM	○	●	●	●	●	●	◐	●	○	●	●	●	●	●	●
27	Night-time low noise operation end setting	<div style="background-color: #cccccc; width: 100%; height: 10px;"></div>							<div style="background-color: #cccccc; width: 100%; height: 10px;"></div>							6:00 AM	○	●	●	●	●	●	◐	○	●	●	●	●	●	◐	
																7:00 AM	○	●	●	●	●	●	◐	●	○	●	●	●	●	●	●
																8:00 AM (Factory setting)	○	●	●	●	●	●	◐	●	○	●	●	●	●	●	●
29	Capacity precedence setting	<div style="background-color: #cccccc; width: 100%; height: 10px;"></div>							<div style="background-color: #cccccc; width: 100%; height: 10px;"></div>							Low noise precedence (Factory setting)	○	●	●	●	●	●	◐	○	●	●	●	●	●	◐	
																Capacity precedence	○	●	●	●	●	●	◐	●	○	●	●	●	●	●	●
30	Demand setting 1	<div style="background-color: #cccccc; width: 100%; height: 10px;"></div>							<div style="background-color: #cccccc; width: 100%; height: 10px;"></div>							60 % of rated power consumption	○	●	●	●	●	●	◐	○	●	●	●	●	●	◐	
																70 % of rated power consumption (Factory setting)	○	●	●	●	●	●	◐	●	○	●	●	●	●	●	●
																80 % of rated power consumption	○	●	●	●	●	●	◐	●	○	●	●	●	●	●	●
32	Constant demand setting	<div style="background-color: #cccccc; width: 100%; height: 10px;"></div>							<div style="background-color: #cccccc; width: 100%; height: 10px;"></div>							OFF (Factory setting)	○	○	●	●	●	●	●	○	●	●	●	●	●	◐	
																ON	○	○	●	●	●	●	●	○	●	●	●	●	●	●	

Setting mode indication section

Setting No. indication section

Set contents indication section

2.6 Setting of Refrigerant Recovery Mode

When carrying out the refrigerant collection on site, fully open the respective electronic expansion valve of indoor and outdoor units

All indoor and outdoor unit's operation are prohibited.

Operation procedure

1. In setting mode 2 with units in stop mode, set the item No.21 (refrigerant recovery / vacuuming mode) to ON. The respective expansion valve of indoor and outdoor units are fully opened. **Test Operation** and **Under Centralized Control** are displayed on the remote controller, and the indoor / outdoor unit operation is prohibited. After setting, do not cancel setting mode 2 until completion of refrigerant recovery operation.
2. Collect the refrigerant using a refrigerant recovery unit. (See the instruction attached to the refrigerant recovery unit for more detail.)
3. Press the **MODE (BS1)** button once and return to setting mode 2.

2.7 Setting of Vacuuming Mode

In order to perform vacuuming operation on site, fully open the electronic expansion valves of indoor and outdoor units and turn on some solenoid valves.

Operating procedure

1. In setting mode 2 with units in stop mode, set the item No.21 (refrigerant recovery / vacuuming mode) to ON. The respective expansion valve of indoor and outdoor units are fully opened. **Test Operation** and **Under Centralized Control** are displayed on the remote controller, and the indoor / outdoor unit operation is prohibited.
After setting, do not cancel setting mode 2 until completion of Vacuuming operation.
2. Use the vacuum pump to perform vacuuming operation.
3. Press the **MODE (BS1)** button once and reset setting mode 2.

2.8 Check Operation

To prevent any trouble in the period of installation on site, the system is provided with a test operation mode enabling check for incorrect wiring, stop valve left in closed, coming out (or misplacing with suction pipe thermistor) or discharge pipe thermistor and judgment of piping length, refrigerant overcharging, and learning for the minimum opening degree of electronic expansion valve.

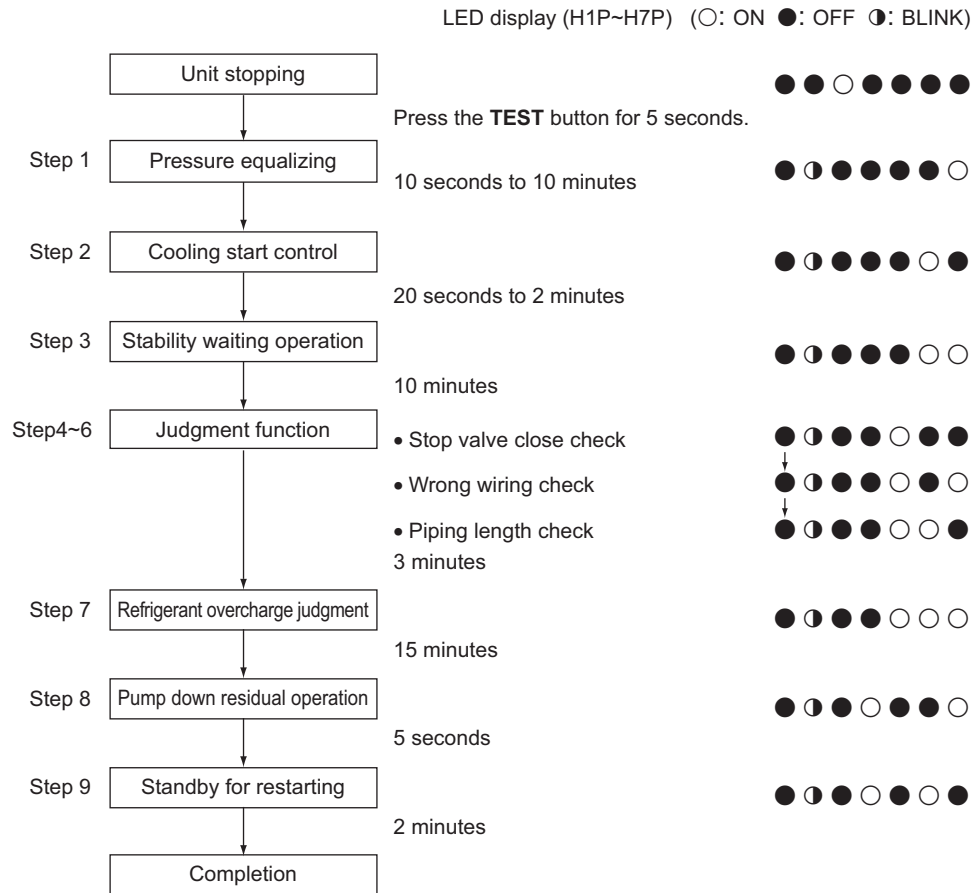

2.9 Setting of Auxiliary Heater Control

To improve efficiency and lower install cost the auxiliary heater can be lockout based on outdoor temperature.

Auxiliary heater maximum allowable temperature

Auxiliary heater is allowed to energize when the outdoor air temperature is smaller than the auxiliary heater maximum allowable temperature.

No.	Setting item display								Setting condition display											
	Setting item	MODE H1P	TEST H2P	C/H selection			Low noise H6P	Demand H7P												
				IND H3P	Master H4P	Slave H5P														
50	Auxiliary heater maximum allowable temperature	○	○	○	●	●	○	●	* Factory setting											
									-17.7°C (0°F)	○	●	●	●	●	●	●	●	●	●	●
									-15°C (5°F)	○	●	●	●	●	●	○	○	○	○	○
									-12.2°C (10°F)	○	●	●	●	●	○	○	○	○	○	○
									-9.4°C (15°F)	○	●	●	●	●	○	○	○	○	○	○
									-6.6°C (20°F)	○	●	●	●	○	○	○	○	○	○	○
									-3.8°C (25°F)	○	●	●	●	○	○	○	○	○	○	○
									-1.1°C (30°F)	○	●	●	●	○	○	○	○	○	○	○
									1.6°C (35°F)	○	●	●	●	○	○	○	○	○	○	○
									4.4°C (40°F)	○	●	●	○	○	○	○	○	○	○	○
									7.2°C (45°F)	○	●	●	○	○	○	○	○	○	○	○
									10°C (50°F)	○	●	●	○	○	○	○	○	○	○	○
									12.7°C (55°F)	○	●	●	○	○	○	○	○	○	○	○
									15.5°C (60°F)	○	●	●	○	○	○	○	○	○	○	○
									18.3°C (65°F)	○	●	●	○	○	○	○	○	○	○	○
										Auxiliary heater always not allowed	○	●	●	○	○	○	○	○	○	○
	Auxiliary heater always allowed	○	●	●	○	○	○	○	○	○	○									

Auxiliary heater maximum allowable temperature release differential

Auxiliary heater is not allowed to energize when the outdoor air temperature is recovered by differential above the auxiliary heater maximum allowable temperature.

No.	Setting item display								Setting condition display										
	Setting item	MODE H1P	TEST H2P	C/H selection			Low noise H6P	Demand H7P											
				IND H3P	Master H4P	Slave H5P													
56	Auxiliary heater maximum allowable temperature release differential	○	○	○	○	●	●	●	* Factory setting										
									2.8°C (5°F)	○	●	●	●	●	●	●	●	●	●
									5.6°C (10°F)	○	●	●	●	●	○	○	○	○	○
	8.3°C (15°F)	○	●	●	●	○	○	○	○	○	○								

2.10 Setting of Heat Pump Lockout and Emergency Heat Mode

Heat pump is locked out when the setting below and/or external input to ABC terminal has been made.

No.	Setting item display								Setting condition display								
	Setting item	MODE H1P	TEST H2P	C/H selection			Low noise H6P	Demand H7P									
				IND H3P	Master H4P	Slave H5P											
16	Setting of heat pump lockout 1	<input type="radio"/>	<input checked="" type="radio"/>	<input type="radio"/>	<input checked="" type="radio"/>	<input checked="" type="radio"/>	<input checked="" type="radio"/>	<input checked="" type="radio"/>	OFF	<input type="radio"/>	<input checked="" type="radio"/>	<input checked="" type="radio"/>	<input checked="" type="radio"/>	<input checked="" type="radio"/>	<input checked="" type="radio"/>	<input type="radio"/>	*
									ON	<input type="radio"/>	<input checked="" type="radio"/>	<input checked="" type="radio"/>	<input checked="" type="radio"/>	<input checked="" type="radio"/>	<input type="radio"/>	<input checked="" type="radio"/>	
37	Setting of heat pump lockout 2	<input type="radio"/>	<input type="radio"/>	<input checked="" type="radio"/>	<input checked="" type="radio"/>	<input type="radio"/>	<input checked="" type="radio"/>	<input type="radio"/>	OFF	<input type="radio"/>	<input checked="" type="radio"/>	<input checked="" type="radio"/>	<input checked="" type="radio"/>	<input checked="" type="radio"/>	<input checked="" type="radio"/>	<input checked="" type="radio"/>	*
									Mode 1	<input type="radio"/>	<input checked="" type="radio"/>	<input checked="" type="radio"/>	<input checked="" type="radio"/>	<input checked="" type="radio"/>	<input checked="" type="radio"/>	<input type="radio"/>	
									Mode 2	<input type="radio"/>	<input checked="" type="radio"/>	<input checked="" type="radio"/>	<input checked="" type="radio"/>	<input checked="" type="radio"/>	<input type="radio"/>	<input checked="" type="radio"/>	
									Mode 3	<input type="radio"/>	<input checked="" type="radio"/>	<input checked="" type="radio"/>	<input checked="" type="radio"/>	<input checked="" type="radio"/>	<input type="radio"/>	<input type="radio"/>	
									Mode 4	<input type="radio"/>	<input checked="" type="radio"/>	<input checked="" type="radio"/>	<input checked="" type="radio"/>	<input type="radio"/>	<input checked="" type="radio"/>	<input checked="" type="radio"/>	
									Mode 5	<input type="radio"/>	<input checked="" type="radio"/>	<input checked="" type="radio"/>	<input checked="" type="radio"/>	<input type="radio"/>	<input checked="" type="radio"/>	<input type="radio"/>	
									Mode 6	<input type="radio"/>	<input checked="" type="radio"/>	<input checked="" type="radio"/>	<input checked="" type="radio"/>	<input type="radio"/>	<input type="radio"/>	<input checked="" type="radio"/>	

Type	Description	Actions						
		Field setting	Shorted between	Heating Thermo-on		Heating Thermo-off		
				Heater	Fan	Heater	Fan	
I	–	Heat-pump heating is always locked out	2-16: ON	–	ON	ON (H/L)	OFF	LL
II	Mode 1	Lockout is controlled by ABC terminals	2-37: Mode 1	A-C	ON	ON (H/L)	OFF	LL
	B-C			OFF				
	Mode 2 (for a heater which does not need airflow)		2-37: Mode 2	A-C		LL		LL
	B-C			OFF		OFF		
	Mode 3	2-37: Mode 3	Same as 2-37: Mode 1, A-C shorted					
	Mode 4	2-37: Mode 4	Same as 2-37: Mode 1, B-C shorted					
Mode 5	2-37: Mode 5	Same as 2-37: Mode 2, A-C shorted						
Mode 6	2-37: Mode 6	Same as 2-37: Mode 2, B-C shorted						

Heat pump lockout temperature

Heat pump would be locked out when the outdoor air temperature is smaller than the heat pump lockout temperature. This setting is only effective when heat pump lockout mode has been set.

No.	Setting item display								Setting condition display									
	Setting item	MODE H1P	TEST H2P	C/H selection			Low noise H6P	Demand H7P										
				IND H3P	Master H4P	Slave H5P												
57	Heat pump lockout temperature	○	○	○	○	●	●	○	* Factory setting									
									-26.1°C (-15°F)	○	●	●	●	●	●	●	●	*
									-23.3°C (-10°F)	○	●	●	●	●	●	○		
									-20.5°C (-5°F)	○	●	●	●	●	○	●		
									-17.7°C (0°F)	○	●	●	●	●	○	○		
									-15°C (5°F)	○	●	●	●	○	●	●		
									-12.2°C (10°F)	○	●	●	●	○	●	○		
									-9.4°C (15°F)	○	●	●	●	○	○	●		
									-6.6°C (20°F)	○	●	●	●	○	○	○		
									-3.8°C (25°F)	○	●	●	○	●	●	●		
									-1.1°C (30°F)	○	●	●	○	●	●	○		
									1.6°C (35°F)	○	●	●	○	●	○	●		
									4.4°C (40°F)	○	●	●	○	●	○	○		
									7.2°C (45°F)	○	●	●	○	○	●	●		
10°C (50°F)	○	●	●	○	○	●	○											
	Forced heat pump lockout	○	●	●	○	○	○	●										

Heat pump lockout release differential

Heat pump would be resumed when the outdoor air temperature is recovered by differential above the heat pump lockout temperature.

No.	Setting item display								Setting condition display									
	Setting item	MODE H1P	TEST H2P	C/H selection			Low noise H6P	Demand H7P										
				IND H3P	Master H4P	Slave H5P												
47	Heat pump lockout release differential	○	○	●	○	○	○	○	* Factory setting									
									2.8°C (5°F)	○	●	●	●	●	●	●		
									5.6°C (10°F)	○	●	●	●	●	●	○	*	
	8.3°C (15°F)	○	●	●	●	●	○	●										

Automatic lockout

When heat pump lockout mode has been set, the auto backup function will automatically be set. This will allow the auxiliary or secondary heat source to be automatically energized in the event of a system failure related to outdoor units.

3. Test Operation

Follow the following procedure to conduct the initial test operation after installation.

3.1 Check Work Prior to Turning Power Supply ON

Check the below items.

- Power wiring
- Control transmission wiring between units
- Earth wire



Check on refrigerant piping / insulation material



Check on amount of refrigerant charge

- Is the power supply appropriate?
- Have you finished a ductwork to drain?
- Have you detach transport fitting?
- Is the wiring performed as specified?
- Are the designated wires used?
- Is the grounding work completed?
Use a 500 V Megger tester to measure the insulation.
Do not use a Megger tester for low voltage circuits.
- Are the setscrews of wiring not loose?
- Is the electrical component box covered with an insulation cover completely?

- Is pipe size proper? (The design pressure of this product is 4.0 MPa (580 psi).)
- Are pipe insulation materials installed securely?
Liquid and gas pipes need to be insulated. (Otherwise causes water leak.)
- Are respective stop valves on liquid and gas line securely open?

- Is refrigerant charged up to the specified amount?
If insufficient, charge the refrigerant from the service port of stop valve on the liquid side with outdoor unit in stop mode after turning power ON.
- Has the amount of refrigerant charge been recorded on "Record Chart of Additional Refrigerant Charge Amount"?

3.2 Turn Power ON

Turn outdoor unit power ON.



Turn indoor unit power ON.



Carry out field setting on outdoor PCB

- Be sure to turn the power ON 6 hours before starting operation to protect compressors.
- Close outside panels of the outdoor unit.

3.3 Test Operation

To start smoothly, a crankcase heater is equipped to the unit. To power up the crankcase heater in advance, be sure to turn on the power supply 6 hours before operation.



Warning

Be sure to inform other installers or attach the front panel well before leaving with the power supply turned on for the outdoor unit.

Before powering on

- Protect the electronic components with insulating tape in accordance with the "Service Precautions" label attached to the front panel.
- All indoor units connected with the outdoor unit will operate automatically after powering on. To ensure safety, ensure that the indoor unit installation has been completed.

1. Powering on ~ test operation

- Make sure to perform a test run first after installation (If the unit is operated with the indoor unit remote controller but without performing a test operation, the error code **U3** will be indicated on the display of the remote controller and the unit will not operate normally).
- After turning on the power supply, do not touch any switches excluding button switches and changeover switches when setting the outdoor unit PCB (A2P).
(For positions of the button switches (BS1~5) and changeover switches (DS1-1, 2) on the PCB, refer to the "Service Precautions" label)
- Check the state of the outdoor units and faulty wiring with this operation.
 - (1)
 - Attach the front panel of the outdoor unit.
 - Turn on the power supply of the outdoor and indoor units.



Caution

To power up the crankcase heater in advance, be sure to turn on the power supply 6 hours before operation.

- (2)
 - Remove the front panel of the outdoor unit.
 - Check LED display of the outdoor unit PCB (A1P, A2P), to observe whether data transmission is normal.

Outdoor unit PCB	A1P	A2P for 18/24 class A1P for 30-48 class						L.N.O.P (Low noise)	DEMAND
		MODE	TEST/HWL	C/H CHANGEOVER					
SERVICE MONITORING LAMP					IND	MASTER	SLAVE		
LED display (Factory setting)	HAP	H1P	H2P	H3P	H4P	H5P	H6P	H7P	
	●	●	●	○	●	●	●	●	

LED display ● Light OFF ○ Light ON ◐ Blinking



Caution

Don't touch the switches other than button switches and changeover switches of the PCB (A2P) during setting. Doing so may result in electric shock.

- (3)
 - If customer wishes to perform quiet operation or demand operation, perform setting with the push buttons (BS1 ~ 5) on outdoor unit PCB (A2P).
 - Operate the push buttons from the opening of the insulating cover. (See Protective range of the "Service Precautions" label for details)



Caution

Power supply has been turned on for outdoor unit, be careful to avoid electric shock.

- Set the push buttons (BS1 ~ 5) after making sure the service monitoring lamp has been ON.

- For setting method, see the "Service Precautions" label attached to the front panel of the outdoor unit. (Be sure to keep a record of the setting items to the "Service Precautions" label.)
 - Don't touch the changeover switches (DS1-1) while setting them. Doing so may result in malfunction.
- (4) ● Check whether the gas side and liquid side stop valves have been opened. Open them if they are closed.

**Caution**

Operation with the stop valve closed may result in compressor malfunction.

- (5) Press **TEST (BS4)** button for 5 seconds or more to perform test operation. See About test operation on the "Service Precautions" label for details.
- Ask other installers to perform test operation or attach the front panel before having to leave the outdoor unit working alone.
 - Test operation is automatically stopped after about 30 minutes (maximum 1 hour) operation. (Perform checks of faulty wiring, closed stop valves & refrigerant charging and auto determination of piping length)
 - After test operation is completed, if there is no error code on the display of the remote controller, the unit can perform normal operation 3 minutes later.
 - The display of the remote controller indicates symbol of test operation during this operation.
- (6) Be sure to attach the front panel of the outdoor unit after test operation is completed.

About test operation

- If operation is started within 12 minutes after the indoor and outdoor units are turned on, the compressor will not operate and H2P will light up.
Before operating, always check whether the symbols indicated on the LED display are those in the table under "1. Powering on ~ test operation (2)".
- In order to ensure uniform refrigerant distribution, it may take up to around 10 minutes for the compressor to start up after the unit starting operation. This is not a malfunction.
- The operation check is not for checking individual indoor units. After completing the operation check, operate the system normally with the remote controller.
- Test operation can't be performed when the unit is in other modes such as refrigerant recycling mode.
- Never perform test operation with discharge pipe thermistor (R2T), suction pipe thermistor (R3T) and pressure sensor (S1NPH, S1NPL) removed. Failure to do so will result in compressor damage.

2. For normal operation

After test operation is completed, operate the unit normally.

(Heating is not possible if the outdoor temperature is 24°C (75.2°F) or higher. Refer to the operation manual.)

1. Check the indoor and outdoor units are in normal operation.
(If a knocking sound produced by liquid compression of the compressor can be heard, stop the unit immediately.)
2. Check to see if cold (or hot) air is coming out from the indoor unit.
3. Press the fan direction and strength buttons of the indoor unit to see if they operate properly.

About normal operation check

- The compressor will not restart in about 5 minutes even if the **ON/OFF** button of the remote controller is pressed.
- When system operation is stopped by the remote controller, the outdoor unit may continue operating for further 1 minute at maximum.
- If any check operation was not performed through test operation on first installation, the error code **U3** will be displayed. In this case, perform check operation in accordance with “1. Powering on ~ test operation”.

3.4 Error Codes and Corresponding Measures

Please check the remote controller connected to the indoor unit for verification.

Error code		Description	Solution
Primary code	Sub code		
E3	01	High pressure switch activated (S1PH)	Check the stop valve or (field) piping abnormality or the airflow on the air cooling heat exchanger.
	02	<ul style="list-style-type: none"> • Too much refrigerant charged • Stop valve closed 	<ul style="list-style-type: none"> • Check the amount of refrigerant and recharge the unit. • Open the stop valve.
	13	Stop valve closed (liquid).	Open the liquid stop valve.
	18	<ul style="list-style-type: none"> • Too much refrigerant charged • Stop valve closed 	<ul style="list-style-type: none"> • Check the amount of refrigerant and recharge the unit. • Open the stop valve.
E4	01	Defective low pressure: <ul style="list-style-type: none"> • Stop valve closed • Refrigerant undercharged • Defective indoor unit 	<ul style="list-style-type: none"> • Open the stop valve. • Check the amount of refrigerant and recharge the unit. • Check the user interface display. • Check the transmission wiring between the indoor and outdoor units.
E9	01	Defective electronic expansion valve (Subcooling) (30-48 class: Y3E)	Check the connection of the PCB or the actuator.
	04	Defective electronic expansion valve (Main) (Y1E)	Check the connection of the PCB or the actuator.
F3	01	Discharge pipe temperature too high: <ul style="list-style-type: none"> • Stop valve closed • Refrigerant undercharged 	<ul style="list-style-type: none"> • Open the stop valve. • Check the amount of refrigerant and recharge the unit.
F6	02	<ul style="list-style-type: none"> • Too much refrigerant charged • Stop valve closed 	<ul style="list-style-type: none"> • Open the stop valve. • Check the amount of refrigerant and recharge the unit.
H9	01	Defective outdoor air thermistor (R1T)	Check the connection of the PCB or the actuator.
J3	16	Defective discharge pipe thermistor (R2T): Tripping	Check the connection of the PCB or the actuator.
	17	Defective discharge pipe thermistor (R2T): Short circuit	Check the connection of the PCB or the actuator.
J5	01	Defective suction pipe thermistor (R3T and R5T): Tripping	Check the connection of the PCB or the actuator.
J6	01	Defective outdoor heat exchanger deicer thermistor (R4T)	Check the connection of the PCB or the actuator.
J7	01	Defective heat exchanger liquid pipe thermistor (R7T)	Check the connection of the PCB or the actuator.
J9	01	Defective subcooling heat exchanger gas pipe thermistor (R6T: 30-48 class only)	Check the connection of the PCB or the actuator.
JA	06	Defective high pressure sensor (S1NPH): Tripping	Check the connection of the PCB or the actuator.
	07	Defective high pressure sensor (S1NPH): Short circuit	Check the connection of the PCB or the actuator.
JC	06	Defective low pressure sensor (S1NPL): Tripping	Check the connection of the PCB or the actuator.
	07	Defective low pressure sensor (S1NPL): Short circuit	Check the connection of the PCB or the actuator.
P1	01	Inverter unbalanced power supply voltage	Check if the power supply meets the specifications.
U2	01	Inverter insufficient voltage	Check if the power supply meets the specifications.
	02	Inverter power supply phase missing	Check if the power supply meets the specifications.
U3	03	System test operation not yet executed (Test operation cannot be executed.)	Execute system test operation.

Error code		Description	Solution
Primary code	Sub code		
U4	01	Q1/Q2 or indoor-outdoor units wiring error	Check (Q1/Q2) wiring.
	03	Q1/Q2 or indoor-outdoor units wiring error	Check (Q1/Q2) wiring.
	04	System test operation ends abnormally.	Re-execute the test operation.
U9	01	System mismatch Mismatched indoor unit models used (R-410A, R-407C, RA, Hydrobox, etc.). Defective indoor unit	Check if there are any other defective indoor units and verify if the indoor unit combination meets requirements.
UA	03	Defective indoor unit connection or mismatched models (R-410A, R-407C, RA, Hydrobox, etc.).	Check if there are any other defective indoor units and verify if the indoor unit combination meets requirements.
	18	Defective indoor unit connection or mismatched models (R-410A, R-407C, RA, Hydrobox, etc.).	Check if there are any other defective indoor units and verify if the indoor unit combination meets requirements.
	31	Wrong combination of units (multi-unit system)	Check the compatibility of unit types.
	49	Wrong combination of units (multi-unit system)	Check the compatibility of unit types.
UF	01	Defective automatic addressing (inconsistency)	Check if the quantity of connected units is below the maximum number of units that can be connected (through monitor mode) or if initiation is complete.
	05	Stop valve closed or defective (During system test operation)	Open the stop valve.
UH	01	Defective automatic addressing (inconsistency)	Check if the quantity of connected units is below the maximum number of units that can be connected (through monitor mode) or if initiation is complete.
A0	01	External protection device abnormality	Check if 24 VAC power has been supplied to R and C terminals. Check if TB4 and TB5 terminals have not been opened. Check F1U fuse.

No display on the remote controller

- Error in connection/communication among indoor unit remote controllers. Check if there is any disconnection or loosening of connectors.



Caution

For the plumber

For the electrician

Before giving the air conditioner back to the customer after a test operation, please make sure that the casing is securely in place and the screws are well fastened.

3.5 When Turning ON Power First Time

The unit cannot be run for up to 12 minutes to automatically set the master power and address (indoor-outdoor address, etc.).

Status

Outdoor unit	Test lamp H2P Blinks Can also be set during operation described above.
Indoor unit	If ON button is pushed during operation described above, the UH error indicator blinks. (Returns to normal when automatic setting is complete.)

3.6 When Turning ON Power the Second Time and Subsequent

Tap the **RESET (BS5)** button on the outdoor unit PCB. Operation becomes possible for about 2 minutes. If you do not push the **RESET (BS5)** button, the unit cannot be run for up to 10 minutes to automatically set master power.

Status

Outdoor unit	Test lamp H2P Blinks Can also be set during operation described above.
Indoor unit	If ON button is pushed during operation described above, the operation lamp lights but the compressor does not operate. (Returns to normal when automatic setting is complete.)

3.7 When an Indoor Unit or Outdoor Unit has been Added, or Indoor or Outdoor Unit PCB has been Changed

Be sure to push and hold the **RESET (BS5)** button for 5 seconds. If not, the addition cannot be recognized. In this case, the unit cannot be run for up to 12 minutes to automatically set the address (indoor-outdoor address, etc.)

Status

Outdoor unit	Test lamp H2P ON Can also be set during operation described above.
Indoor unit	If ON button is pushed during operation described above, the UH or U4 error indicator blinks. (Returns to normal when automatic setting is complete.)

Part 6

Service Diagnosis

1. Servicing Items to be Confirmed	232
1.1 Troubleshooting.....	232
1.2 Precautions for Maintenance.....	232
1.3 Refrigerant Properties (R-410A).....	234
2. Symptom-based Troubleshooting	235
2.1 Indoor Unit Overall	235
2.2 With Infrared Presence/Floor Sensor	238
3. Error Code via Remote Controller	239
3.1 Wired Remote Controller	239
3.2 Wireless Remote Controller	240
4. Error Code Indication by Outdoor Unit PCB.....	242
5. Troubleshooting by Error Codes	246
5.1 Error Codes and Description	246
5.2 Error Codes - Sub Codes	248
5.3 External Protection Device Abnormality (Except FTQ-TA).....	249
5.4 External Protection Device Abnormality (FTQ-TA Only)	250
5.5 Indoor Unit PCB Abnormality	251
5.6 Drain Level Control System (S1L) Abnormality.....	252
5.7 Indoor Fan Motor (M1F) Lock, Overload	254
5.8 Indoor Fan Motor Abnormality	256
5.9 Blower Motor Not Running	262
5.10 Indoor Fan Motor Status Abnormality.....	263
5.11 Low Indoor Airflow	264
5.12 Swing Flap Motor Abnormality	265
5.13 Power Supply Voltage Abnormality	267
5.14 Blower Motor Stops for Over/Under Voltage	268
5.15 Electronic Expansion Valve Coil Abnormality, Dust Clogging	269
5.16 Drain Level Above Limit	270
5.17 Self-Cleaning Decoration Panel Abnormality	271
5.18 Defective Capacity Setting	282
5.19 Transmission Abnormality (between Indoor Unit PCB and Fan PCB)	283
5.20 Blower Motor Communication Error	285
5.21 Thermistor Abnormality	286
5.22 Combination Abnormality (between Indoor Unit PCB and Fan PCB).....	287
5.23 Blower Motor HP Mismatch.....	288
5.24 Indoor Blower Does Not Have Required Parameters to Function.....	289
5.25 Remote Sensor Abnormality	290
5.26 Infrared Presence/Floor Sensor Error	291
5.27 Remote Controller Thermistor Abnormality	296

5.28	Outdoor Main PCB Abnormality	297
5.29	Activation of High Pressure Switch	298
5.30	Activation of Low Pressure Sensor	300
5.31	Compressor Motor Lock	302
5.32	Outdoor Fan Motor Abnormality	304
5.33	Electronic Expansion Valve Coil Abnormality	306
5.34	Discharge Pipe Temperature Abnormality	307
5.35	Refrigerant Overcharged	308
5.36	Thermistor Abnormality	309
5.37	High Pressure Sensor Abnormality	310
5.38	Low Pressure Sensor Abnormality	311
5.39	Inverter PCB Abnormality	312
5.40	Radiation Fin Temperature Rise Abnormality	313
5.41	Compressor Instantaneous Overcurrent	314
5.42	Compressor Overcurrent	315
5.43	Compressor Startup Abnormality	316
5.44	Transmission Error between Microcomputers on Outdoor Unit Main PCB	317
5.45	Inverter Circuit Capacitor High Voltage	318
5.46	Radiation Fin Thermistor Abnormality	319
5.47	Refrigerant Shortage	320
5.48	Power Supply Insufficient or Instantaneous Abnormality	322
5.49	Check Operation Not Executed	324
5.50	Transmission Error between Indoor Units and Outdoor Units	325
5.51	Transmission Error between Remote Controller and Indoor Unit	327
5.52	Transmission Error between Main and Sub Remote Controllers	328
5.53	Transmission Error between Indoor and Outdoor Units in the Same System	329
5.54	Improper Combination of Indoor and Outdoor Units, Indoor Units and Remote Controller	330
5.55	Incorrect Electric Heater Capacity Setting	332
5.56	Address Duplication of Centralized Controller	333
5.57	Transmission Error between Centralized Controller and Indoor Unit	334
5.58	System Not Set	335
5.59	System Abnormality, Refrigerant System Address Undefined	336
6.	Check	337
6.1	High Pressure Check	337
6.2	Low Pressure Check	338
6.3	Superheat Operation Check	340
6.4	Power Transistor Check	342
6.5	Refrigerant Overcharge Check	343
6.6	Refrigerant Shortage Check	344
6.7	Vacuuming and Dehydration Procedure	345
6.8	List of Inverter-Related Error Codes	346
6.9	Concept of Inverter-Related Error Codes	347
6.10	Thermistor Check	348
6.11	Pressure Sensor Check	351
6.12	Broken Wire Check of the Relay Wires	352
6.13	Fan Motor Connector Check	353

6.14 Electronic Expansion Valve Coil Check	355
6.15 Fan Motor Connector Check for FTQ-TA	358

1. Servicing Items to be Confirmed

1.1 Troubleshooting

(1) Initial verification and troubleshooting

1. Properly understand the end user's needs and issues.
2. Check the cause of errors according to the description provided by the end user.
3. Check if the remote controller displays any error codes.
(Or use the outdoor unit monitoring mode to check for errors).
4. If there is no display of error codes, refer to **Symptom-based Troubleshooting** on page 235 for diagnosis.
If an error code is displayed, refer to troubleshooting flowchart for diagnosis.

(2) Take appropriate measures.

1. Repair the defect or replace the parts according to the troubleshooting results.
2. Turn off the power supply for 10 minutes before disassembling.
3. The refrigerant has to be collected before refrigerant system components are replaced.

(3) Verification after taking appropriate measures

1. Run the unit after repairing the defect to confirm normal unit operation.
2. Record the check results and inform the client.

1.2 Precautions for Maintenance

Pay attention to the following matters in servicing.

(1) Precaution for maintenance

Touch the paint-free metal part of the product (electrical box lid of the standard model; tap bolts of electrical box of anti-corrosion and heavy anti-corrosion models) to release static electricity before starting work.

(2) Precautions for maintaining the service cover

After maintenance, make sure to close the service cover.

(Otherwise, leakage of water or contamination by foreign matter may cause defects)

(3) Precautions for maintaining the electrical box

1. Turn off the power for 10 minutes before opening the cover of the electrical box.
2. After opening the cover, use the tester to measure the terminal voltage of the power supply terminal to make sure that the power has been cut.
Then check if the circuit capacitor voltage is under 50 VDC.
3. To avoid PCB defects, touch the earth terminal of the electrical box with your hand when unplugging the connector to release static electricity.
4. Unplug the connectors X106A and X107A (30-48 class only), of the outdoor fan motor.
When unplugging the connectors, do not touch the live parts.
(When the outdoor fan is rotating because of strong wind, there is a risk of electric shock due to main circuit board capacitor power storage.)
5. After maintenance, reconnect the connectors of the outdoor fan in their original positions.
 - ♦ Otherwise, the remote controller will display error code **E7**, preventing normal operation.

(4) Precautions for piping work and refrigerant charging:

This unit uses R-410A refrigerant. Pay attention to the following conditions.

1. The charging pipe and the manifold tube use R-410A products for pressure maintenance and avoiding contamination by impurities (SUNISO oil, etc.).
2. Be sure to purge with nitrogen when brazing.
 - ◆ Properly perform airtightness test and vacuum drying. (Airtight test pressure: 4.0 MPa (580 psi))
 - ◆ Charge refrigerant in liquid state.

(5) Precautions for operating in servicing mode (field setting):

When a test operation is interrupted or after exiting service mode, please wait for at least one minute before entering service mode again. In case of continuous execution, the outdoor unit PCB may sometimes display an error code. If any error codes are displayed, press the **RETURN (BS3)** button. If performing the above operation still does not eliminate the error, reconnect the unit to the power supply.

1.3 Refrigerant Properties (R-410A)

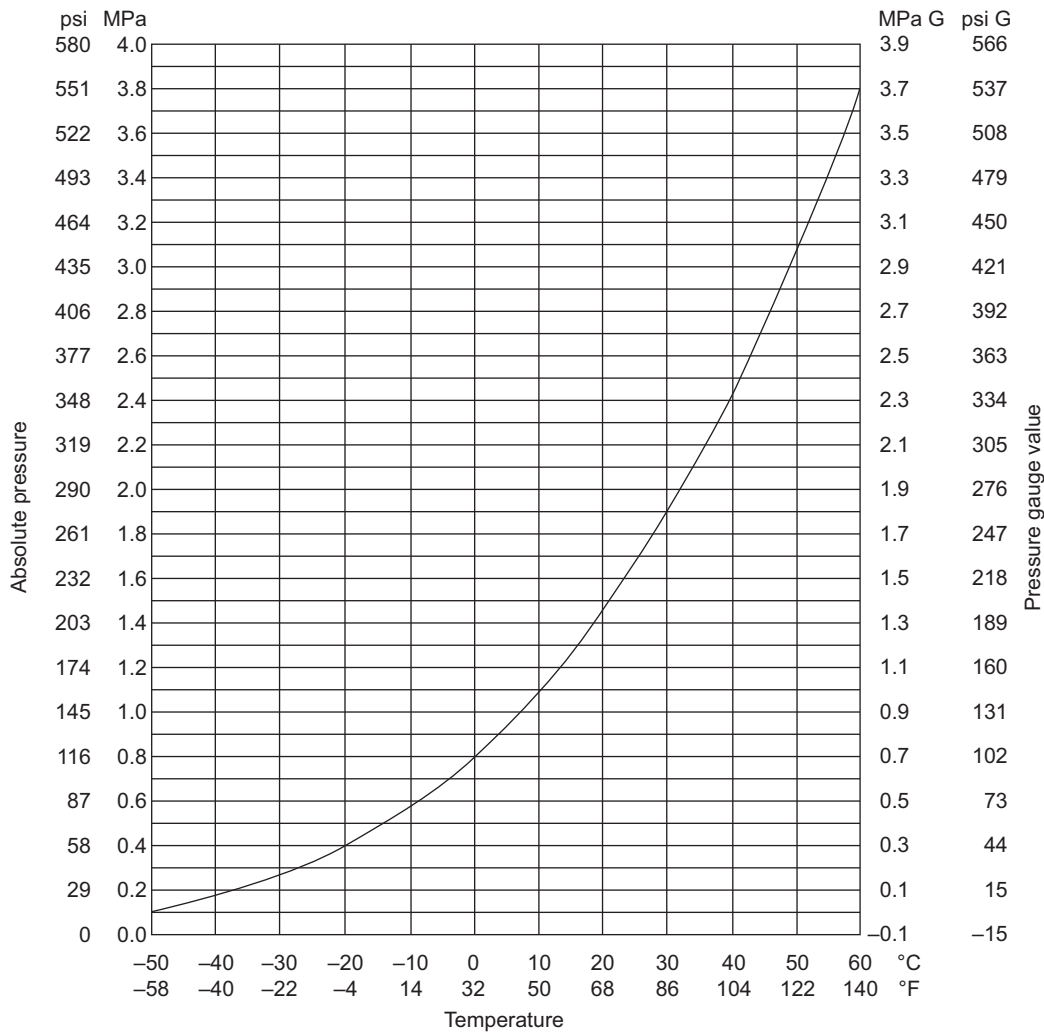

Temperature		Absolute Pressure		Temperature		Absolute Pressure		Temperature		Absolute Pressure		Temperature		Absolute Pressure	
°C	°F	MPa	psi	°C	°F	MPa	psi	°C	°F	MPa	psi	°C	°F	MPa	psi
-50	-58	0.11	16.0	-20	-4	0.40	58.0	10	50.0	1.09	158	40	104.0	2.42	351
-48	-54.4	0.12	17.4	-18	-0.4	0.43	62.4	12	53.6	1.15	167	42	107.6	2.54	368
-46	-50.8	0.13	18.9	-16	3.2	0.46	66.7	14	57.2	1.22	177	44	111.2	2.67	387
-44	-47.2	0.15	21.8	-14	6.8	0.50	72.5	16	60.8	1.29	187	46	114.8	2.80	406
-42	-43.6	0.16	23.2	-12	10.4	0.54	78.3	18	64.4	1.37	199	48	118.4	2.93	425
-40	-40	0.18	26.1	-10	14	0.57	82.7	20	68.0	1.45	210	50	122.0	3.07	445
-38	-36.4	0.19	27.6	-8	17.6	0.61	88.5	22	71.6	1.53	222	52	125.6	3.21	466
-36	-32.8	0.21	30.5	-6	21.2	0.66	95.7	24	75.2	1.61	234	54	129.2	3.36	487
-34	-29.2	0.23	33.4	-4	24.8	0.70	102	26	78.8	1.70	247	56	132.8	3.51	509
-32	-25.6	0.25	36.3	-2	28.4	0.75	109	28	82.4	1.79	260	58	136.4	3.64	528
-30	-22	0.27	39.2	0	32	0.80	116	30	86.0	1.89	274	60	140.0	3.83	555
-28	-18.4	0.29	42.1	2	35.6	0.85	123	32	89.6	1.99	289	62	143.6	4.00	580
-26	-14.8	0.32	46.4	4	39.2	0.91	132	34	93.2	2.09	303	64	147.2	4.17	605
-24	-11.2	0.34	49.3	6	42.8	0.96	139	36	96.8	2.20	319	—	—	—	—
-22	-7.6	0.37	53.7	8	46.4	1.02	148	38	100.4	2.31	335	—	—	—	—

2. Symptom-based Troubleshooting

2.1 Indoor Unit Overall

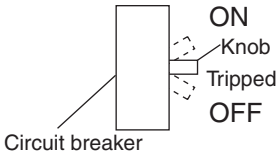
	Symptom	Supposed Cause	Countermeasure	
1	The system does not start operation at all.	Blowout of fuse(s)	Turn OFF the power supply and then replace the fuse (s).	
		Cutout of breaker(s)	<ul style="list-style-type: none"> • If the knob of any breaker is in its OFF position, turn ON the power supply. • If the knob of any circuit breaker is in its tripped position, do not turn ON the power supply.  <p>The diagram shows a vertical rectangular circuit breaker with a knob on the right side. The knob has three positions: 'ON' at the top, 'Tripped' in the middle, and 'OFF' at the bottom. A dashed line indicates the knob's movement between these positions. A label 'Circuit breaker' points to the main body of the device.</p>	
		Power failure	After the power failure is reset, restart the system.	
		The connector loose or not fully plugged in	Turn off the power supply to verify the connection of the connector.	
2	The system starts operation but makes an immediate stop.	Blocked air inlet or outlet of indoor or outdoor unit	Remove obstacle(s).	
		Clogged air filter(s)	Clean the air filter(s).	
3	The system does not cool or heat air well.	Blocked air inlet or outlet of indoor or outdoor unit	Remove obstacle(s).	
		Clogged air filter(s)	Clean the air filter(s).	
		Enclosed outdoor unit(s)	Remove the enclosure.	
		Improper set temperature	Set the temperature to a proper degree.	
		Airflow rate set to LOW	Set it to a proper airflow rate.	
		Improper direction of air diffusion	Set it to a proper direction.	
		Open window(s) or door(s)	Shut it tightly.	
		IN COOLING Direct sunlight received	Hang curtains or shades on windows.	
		IN COOLING Too many persons staying in a room	The model must be selected to match the air conditioning load.	
		IN COOLING Too many heat sources (e.g. OA equipment) located in a room		
	IN DRYING The reason is that the dry operation serves not to reduce the room temperature where possible.	Change the system to cooling operation.		
4	The system does not operate.	The system stops and immediately restarts operation.	Normal operation. The system will automatically start operation after a lapse of five minutes.	
		Pressing the temperature setting button immediately resets the system.		
		The remote controller displays CENTRAL CONTROL , which blinks for a period of several seconds when the OPERATION button is depressed.	The system is controlled with centralized controller. Blinking display indicates that the system cannot be operated using the remote controller.	Operate the system using the COOL/HEAT central remote controller.
		The system stops immediately after turning ON the power supply.	The system is in preparation mode of microcomputer operation.	Wait for a period of approximately one minute.
5	The system makes intermittent stops.	The remote controller displays error codes U4 or U5 , and the system stops but restarts after a lapse of several minutes.	The system stops due to an interruption in communication between units caused by electrical noises coming from equipment other than air conditioners.	Remove causes of electrical noises. If these causes are removed, the system will automatically restart operation.

	Symptom	Supposed Cause	Countermeasure	
6	COOL/HEAT selection is disabled.	The remote controller displays CENTRAL CONTROL .	This remote controller has no option to select cooling operation.	Use a remote controller with option to select cooling operation.
		The remote controller displays CENTRAL CONTROL , and the COOL/HEAT selection remote controller is provided.	COOL/HEAT selection is made using the COOL/HEAT selection remote controller.	Use the COOL/HEAT selection remote controller to select cool or heat.
7	The system conducts fan operation but not cooling or heating operation.	This symptom occurs immediately after turning ON the power supply.	The system is in preparation mode of operation.	Wait for a period of approximately 10 minutes.
		The remote controller displays CENTRAL CONTROL ; no cooling or heating operation is performed. Switch to fan operation.	In thermal storage operation, the unit is set to fan operation in cooling or heating operation, and the remote controller shows CENTRAL CONTROL .	Normal operation.
8	The airflow rate is not reproduced according to the setting.	Even pressing the airflow rate setting button makes no changes in the airflow rate.	In heating operation, when the room temperature reaches the set degree, the outdoor unit will stop while the indoor unit is brought to fan LL operation so that no one gets cold air. Furthermore, if fan operation mode is selected when other indoor unit is in heating operation, the system will be brought to fan LL operation.	Normal operation.
9	The airflow direction is not reproduced according to the setting.	The airflow direction is not corresponding to that displayed on the remote controller. The flap does not swing.	Automatic control	Normal operation.
10	A white mist comes out from the system.	Indoor unit In cooling operation, the ambient humidity is high. (This indoor unit is installed in a place with much oil or dust.)	Uneven temperature distribution due to heavy stain of the inside of the indoor unit	Clean the inside of the indoor unit.
		Indoor unit Immediately after cooling operation stopping, the indoor air temperature and humidity are low.	Hot gas (refrigerant) that has flowed in the indoor unit results to be vapor from the unit.	Normal operation.
		Indoor and outdoor units After the completion of defrost operation, the system is switched to heating operation.	Defrosted moisture turns to be vapor and comes out from the units.	Normal operation.
11	The system produces sounds.	Indoor unit Immediately after turning ON the power supply, indoor unit produces ringing sounds.	These are operating sounds of the electronic expansion valve of the indoor unit.	Normal operation. This sound becomes low after a lapse of approximately one minute.
		Indoor and outdoor units Hissing sounds are continuously produced while in cooling or defrost operation.	These sounds are produced from gas (refrigerant) flowing respectively through the indoor and outdoor units.	Normal operation.
		Indoor and outdoor units Hissing sounds are produced immediately after the startup or stop of the system, or the startup or stop of defrost operation.	These sounds are produced when the gas (refrigerant) stops or changes flowing.	Normal operation.
		Indoor unit Faint sounds are continuously produced while in cooling operation or after stopping the operation.	These sounds are produced from the drain discharge device in operation.	Normal operation.
		Indoor unit Creaking sounds are produced while in heating operation or after stopping the operation.	These sounds are produced from resin parts expanding and contracting with temperature changes.	Normal operation.
		Outdoor unit Pitch of operating sounds changes.	The reason is that the compressor changes the operating frequency.	Normal operation.

	Symptom		Supposed Cause	Countermeasure
12	Dust comes out from the system.	Dust comes out from the system when it restarts after the stop for an extended period of time.	Dust, which has deposited on the inside of indoor unit, is blown out from the system.	Normal operation.
13	Odors come out from the system.	In operation	Odors of room, cigarettes or else adsorbed to the inside of indoor unit are blown out.	The inside of the indoor unit should be cleaned.
14	Outdoor fan does not rotate.	In operation	The reason is that fan revolutions are controlled to put the operation to the optimum state.	Normal operation.
15	LCD display 88 or Checking the connection. Please stand by. appears on the remote controller.	Immediately after turning ON the power supply	The reason is that the system is checking to be sure the remote controller is normal.	Normal operation. This code is displayed for a period of approximately one minute at maximum.
16	The outdoor unit compressor or the outdoor fan does not stop.	After stopping operation	It stops in order to prevent oil or refrigerant from dwelling.	Normal operation. It stops after a lapse of approximately 5 to 10 minutes.
17	The outdoor gets hot.	While stopping operation	The reason is that the compressor is warmed up to provide smooth startup of the system.	Normal operation.

2.2 With Infrared Presence/Floor Sensor

	Condition	Measure
1	"Louver operation different from setting" or "No downward airflow in heating operation"	Refer to the flowchart below.
2	Individual airflow direction setting different from the actual airflow direction	· Check the "Louver operation different from setting" error diagnosis.
3	While not operating, the louver does not close completely.	Turn off the circuit breaker and then turn it on again.
4	The remote controller menu does not display energy saving operating mode for when people are not present.	Refer to Infrared Presence/Floor Sensor Error (CE) in troubleshooting.
	The remote controller menu does not display the stop function for when people are not present.	
	The remote controller menu does not display the automatic draft prevention function.	
5	The menu does not display the eco-friendly display function.	No defect. Set the clock.
6	During cooling and dry operation, the louver automatically switches from horizontal (P0) to one-level downward (P1).	No defect. When relative ambient humidity is higher, automatic louver control will be activated.
7	During heating operation, the use of an airflow block will not cause other louvers to turn downward (P4).	No defect. In heating operation, if an airflow block is set, then the air outlet control outdoor the airflow block will be within the range P0-P3.
8	When using airflow block, the airflow block will be routinely lifted (become horizontal) during heating operation.	No defect. Set louver to horizontal (P0) during thermostat OFF.
9	The infrared presence sensor determines that there is someone in the room while no one is there.	Check if there are any objects that generate temperature change when moving. For example: · An electric heater with swing function · Doors, curtains, blind switches · Output of paper from a fax machine or a printer · Turning on/off of incandescent lights · Moving objects
10	The infrared presence sensor determines that there is no one in the room while someone is there.	Check for the following conditions. · Lack of movement · Facing away from the sensor · Little skin exposed · Slight movement in a place far from the sensor
11	Large difference between floor temperature and actual temperature	Check for the following conditions. · Sensor detection zone affected by solar radiation · High or low temperature objects in the sensor detection zone · Large difference between floor temperature and temperature of the living space · Sensors installed near walls may be affected by wall temperature.

Error diagnosis of "Louver operation different from setting"

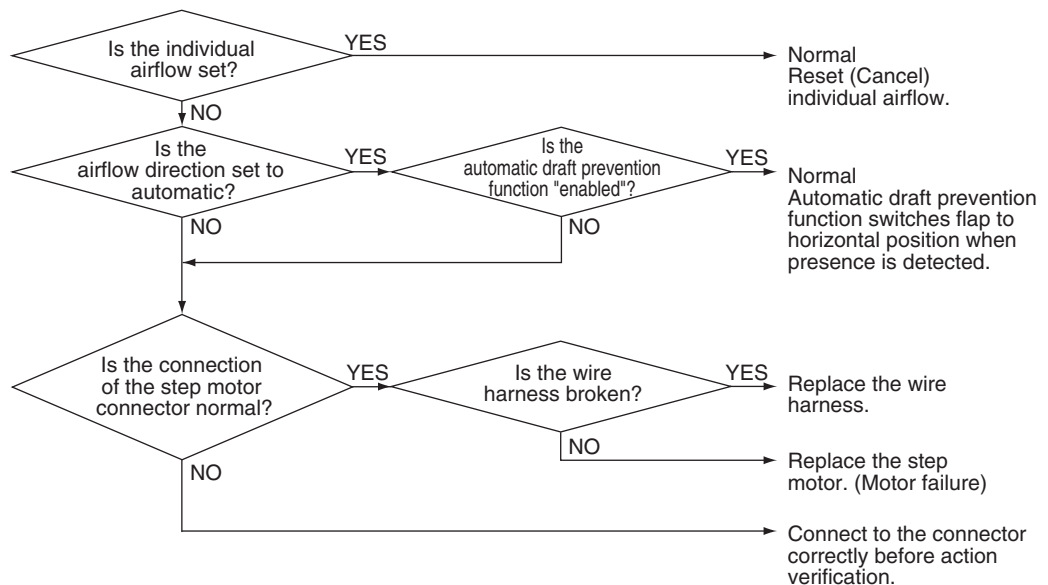

3. Error Code via Remote Controller

3.1 Wired Remote Controller

3.1.1 BRC1E73

The following will be displayed on the screen when an error (or a warning) occurs during operation. Check the error code and take the corrective action specified for the particular model.

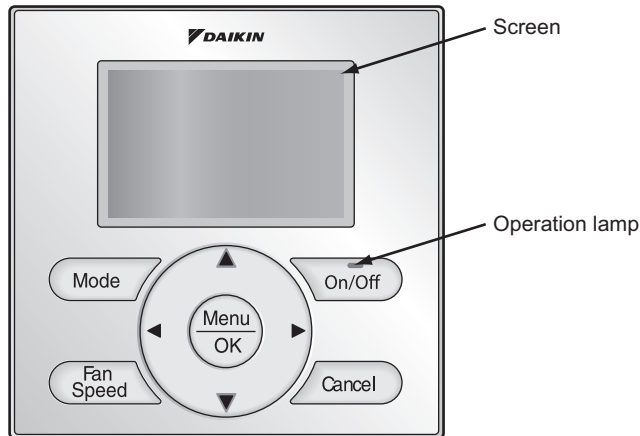

(1) Check if it is an error or warning.

	Operation Status		Display
Abnormal shutdown	The system stops operating.	The operation lamp (green) starts to blink. The message Error: Push Menu button will blink at the bottom of the screen.	
Warning	The system continues its operation.	The operation lamp (green) remains on. The message Warning: Push Menu button will blink at the bottom of the screen.	

(2) Taking corrective action.

Press the **Menu/OK** button to check the error code.





Take the corrective action specific to the model.

Error Code:A6-01	— Error code
Indoor Model FCQ18TAVJU Outdoor Model	— Applicable model names

3.1.2 BRC1H71W

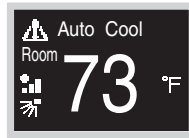
Home screen



When the indoor unit is in error, the controller will display  on the home screen.

Information screen

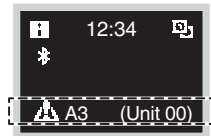



Press and hold  on the Home screen for 5 seconds. The unit number and error code will be displayed at the bottom of the information screen.

3.2 Wireless Remote Controller

If unit stops due to an error, the operation indicating LED on the signal receiving part of indoor unit blinks.

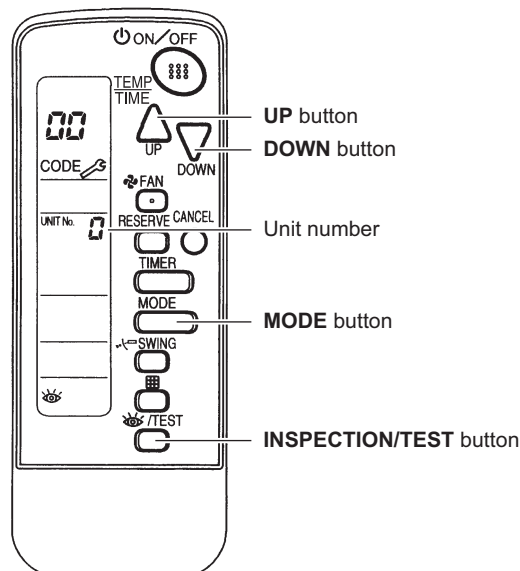
The error code can be determined by following the procedure described below. (The error code is displayed when an operation error has occurred. In normal condition, the error code of the last problem is displayed.)



1. Press **INSPECTION/TEST** button to enter inspection mode. Then the figure  blinks on the unit number display.
2. Press **UP** button or **DOWN** button and change the unit number until the receiver of the remote controller starts to beep.
 - 3 short beeps** : Follow all steps below.
 - 1 short beep** : Follow steps 3 and 4. Continue the operation in step 4 until you hear a continuous beep. This continuous beep indicates that the error code is confirmed.
 - Continuous beep** : There is no abnormality.
3. Press **MODE** button. The left  (upper digit) indication of the error code blinks.
4. Press **UP** button or **DOWN** button to change the error code upper digit until the receiver of the indoor unit starts to beep.

- The upper digit of the code changes as shown below.



Continuous beep : Both upper and lower digits match. (Error code is confirmed.)

2 short beeps : The upper digit matches but the lower digit does not.

1 short beep : The upper digit does not match.

5. Press **MODE** button. The right 0 (lower digit) indication of the error code blinks.
6. Press **UP** button or **DOWN** button and change the error code lower digit until the receiver of the indoor unit generates a continuous beep.

- The lower digit of the code changes as shown below.

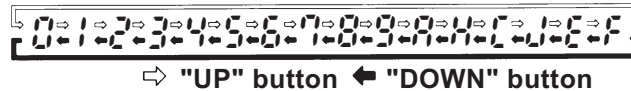

Continuous beep : Both upper and lower digits match. (Error code is confirmed.)

2 short beeps : The upper digit matches but the lower digit does not.

1 short beep : The upper digit does not match.

7. Press **MODE** button to return to the normal mode. If you do not press any button for 1 minute, the remote controller automatically returns to the normal mode.

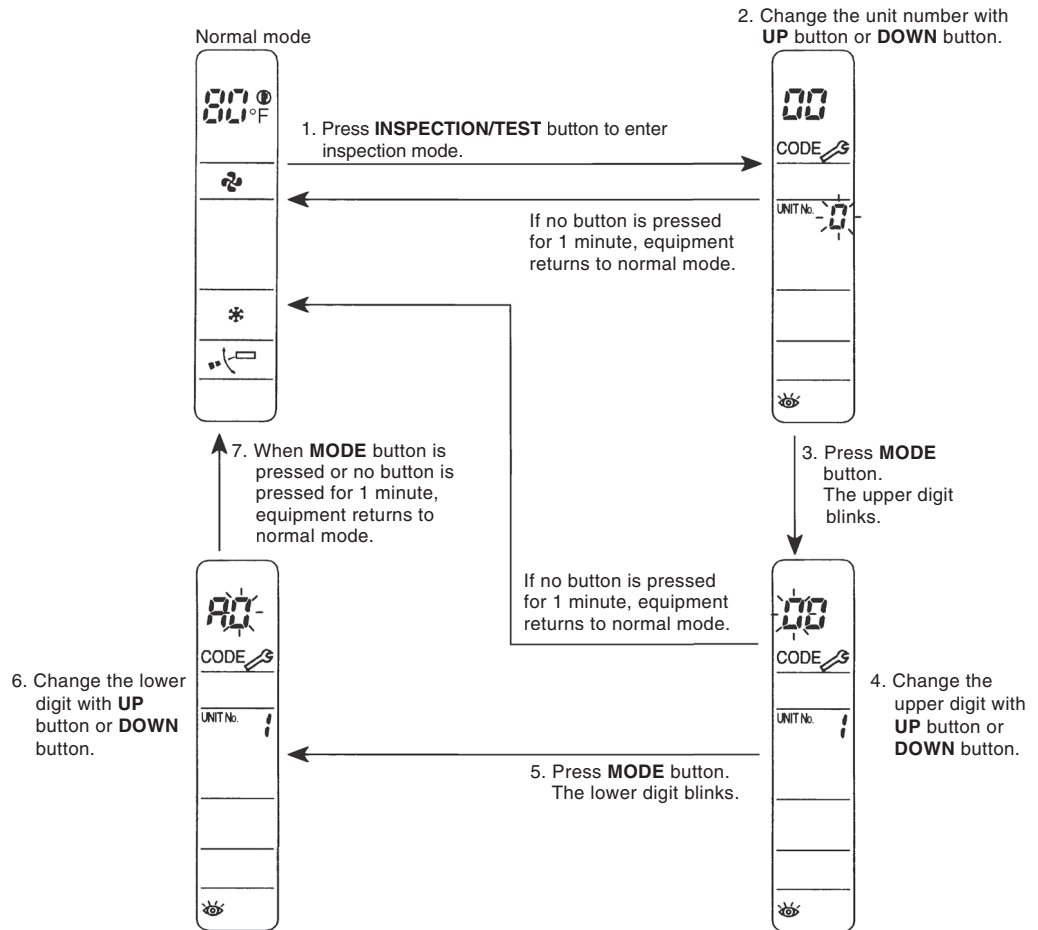

4. Error Code Indication by Outdoor Unit PCB

Monitor mode

To enter the monitor mode, press the **MODE (BS1)** button when in "Setting mode 1".

Selection of setting item

Press the **SET (BS2)** button and set the LED display to a setting item.

Confirmation of error 1

Press the **RETURN (BS3)** button once to display "First digit" of error code.

Confirmation of error 2

Press the **SET (BS2)** button once to display "Second digit" of error code.

Confirmation of error 3

Press the **SET (BS2)** button once to display "error location".

Confirmation of error 4

Press the **SET (BS2)** button once to display "master or slave 1 or slave 2" and "error location".

Press the **RETURN (BS3)** button and switches to the initial status of "Monitor mode".

* Press the **MODE (BS1)** button and return to "Setting mode 1".

Detailed description on next page.

Error Description		Error Code
PCB abnormality		E1
Abnormal high pressure switch	High pressure switch activated	E3
Abnormal low pressure switch	Low pressure switch activated	E4
Compressor lock	Detection of inverter compressor lock	E5
Overload, overcurrent, abnormal lock of outdoor fan motor	Detection of DC fan 1 motor lock	E7
	Detection of DC fan 2 motor lock	
Electronic expansion valve abnormality	Main	E9
	Subcooling	
Abnormal discharge pipe temperature	Abnormal Tdi	F3
Abnormal heat exchanger temperature	Refrigerant overcharge	F6
Defective thermistor of outdoor air temperature	Defective Ta sensor (short)	H9
Defective discharge pipe thermistor	Defective Tdi sensor (short)	J3
Defective suction pipe thermistor	Defective Ts1 sensor (short)	J5
	Defective Ts2 sensor (short)	
Defective outdoor heat exchanger deicer thermistor	Defective Tb sensor (short)	J6
Defective outdoor heat exchanger liquid pipe thermistor	Defective Tl sensor (short)	J7
Defective subcooling heat exchanger gas pipe thermistor	Defective Tsh sensor (short)	J9
Defective sensor of high pressure	Defective Pc sensor (short)	JA
Defective sensor of low pressure	Defective Pe sensor (short)	JC
Defective PCB (for inverter compressor)	Defective IPM	L1
	Abnormal current sensor offset	
	Abnormal IGBT	
	Defective current sensor	
	Abnormal SP-PAM overvoltage	
	Abnormal Interleave	
Inverter radiation fin temperature rising	Overheating of inverter radiation fin temperature	L4
	Inverter instantaneous overcurrent	
	DC output overcurrent	
	Electronic thermal	
	Electronic thermal switch 1	
Electronic thermal	Electronic thermal switch 2	L8
	Out-of-step	
	Speed down after startup	
	Lightening detection	
	Stall prevention (Limit time)	
Stall prevention (Defective start up)		
Abnormal wave form in startup		
Out-of-step		
Transmission error (Between microcomputers on the outdoor main PCB)		LC

○: ON ●: OFF ◐: Blink

Error Code	Confirmation of Error 1							Confirmation of Error 2							Confirmation of Error 3							Confirmation of Error 4						
	H1P	H2P	H3P	H4P	H5P	H6P	H7P	H1P	H2P	H3P	H4P	H5P	H6P	H7P	H1P	H2P	H3P	H4P	H5P	H6P	H7P	H1P	H2P	H3P	H4P	H5P	H6P	H7P
E1	◐	◐	●	●	●	◐	◐	◐	●	○	●	●	●	◐	◐	○	●	●	●	●	●	◐	○	○	●	●	◐	◐
E3								◐	●	○	●	●	◐	◐	◐	○	●	●	●	●	●	◐	○	○	●	●	◐	◐
E4								◐	●	○	●	◐	●	◐	◐	○	●	●	●	●	●	◐	○	○	●	●	◐	◐
E5								◐	●	○	●	◐	●	◐	◐	○	●	●	●	●	●	◐	○	○	●	●	◐	◐
E7								◐	●	○	●	◐	◐	◐	◐	○	●	●	●	●	●	◐	○	○	●	●	◐	◐
E9								◐	●	○	◐	●	●	◐	◐	○	●	●	●	●	●	◐	○	○	●	●	◐	◐
F3	◐	◐	●	●	◐	●	◐	◐	●	○	●	●	◐	◐	◐	○	●	●	●	●	●	◐	○	○	●	●	◐	◐
F6								◐	●	○	●	◐	◐	◐	◐	○	●	●	●	●	●	◐	○	○	●	●	◐	◐
H9	◐	◐	●	●	◐	●	◐	◐	●	○	◐	●	●	◐	◐	○	●	●	●	●	●	◐	○	○	●	●	◐	◐
J3	◐	◐	●	●	◐	◐	●	◐	●	○	●	●	◐	◐	◐	○	●	●	●	●	●	◐	○	○	●	●	◐	◐
J5								◐	●	○	●	◐	◐	◐	◐	○	●	●	●	●	●	◐	○	○	●	●	◐	◐
J6								◐	●	○	●	◐	◐	◐	◐	○	●	●	●	●	●	◐	○	○	●	●	◐	◐
J7								◐	●	○	●	◐	◐	◐	◐	○	●	●	●	●	●	◐	○	○	●	●	◐	◐
J9								◐	●	○	◐	●	●	◐	◐	○	●	●	●	●	●	◐	○	○	●	●	◐	◐
JA								◐	●	○	◐	●	◐	◐	◐	○	●	●	●	●	●	◐	○	○	●	●	◐	◐
JC								◐	●	○	◐	◐	◐	◐	◐	○	●	●	●	●	●	◐	○	○	●	●	◐	◐
L1	◐	◐	●	●	◐	◐	◐	◐	●	○	●	●	●	◐	◐	○	●	●	●	●	●	◐	○	○	●	●	◐	◐
L4								◐	●	○	●	◐	◐	◐	◐	○	●	●	●	●	●	◐	○	○	●	●	◐	◐
L5								◐	●	○	●	◐	◐	◐	◐	○	●	●	●	●	●	◐	○	○	●	●	◐	◐
L8								◐	●	○	◐	●	●	◐	◐	○	●	●	●	●	●	◐	○	○	●	●	◐	◐
L9								◐	●	○	◐	●	●	◐	◐	○	●	●	●	●	●	◐	○	○	●	●	◐	◐
LC								◐	●	○	◐	◐	◐	◐	◐	○	●	●	●	●	●	◐	○	○	●	●	◐	◐

Display of error description (first digit)

Display of error description (second digit)

Display 1 of error in detail

Display 2 of error in detail

*1

●	●	Master
●	◐	Slave1
◐	●	Slave2
◐	◐	System

Monitor mode

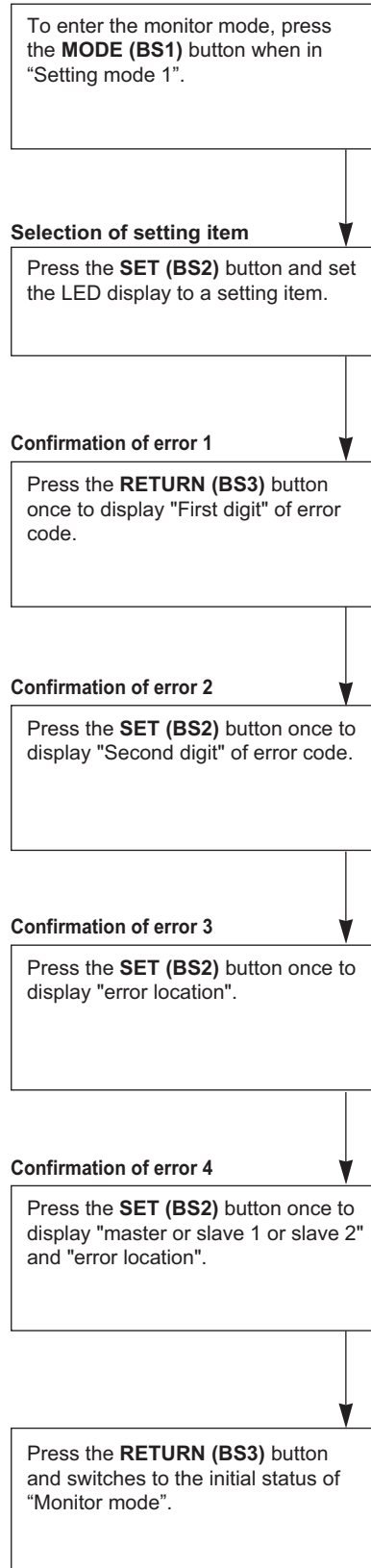

* Press the **MODE (BS1)** button and return to "Setting mode 1".

Error Description		Error Code
Inverter circuit capacitor high voltage	Imbalance of inverter power supply voltage	P1
Defective temperature sensor of inverter radiation fin	Defective thermistor of inverter fin	P4
Refrigerant shortage	Refrigerant shortage alarm	U0
	Liquid pipe temperature abnormality	
Abnormal power supply voltage	Insufficient Inverter voltage	U2
	Open phase in inverter (Phase T)	
	Error due to SP-PAM overvoltage	
	Error due to P-N short circuit	
No implementation of test-run		U3
Transmission error between indoor and outdoor unit	I/O transmission error	U4
	Indoor unit system error	
Transmission error of other system	Indoor unit system abnormal in other system or other indoor unit system abnormal in own system	U9
Erroneous field setting	System transmission error	UA
	Overconnection error of indoor units	
	Error of field setting	
	Refrigerant abnormal	
	Connection error (BP unit)	
Conflict in wiring and piping, no setting for system	Conflict in wiring and piping	UF
Defective system	Wiring error (Auto-address error)	UH

Detailed description on next page.

○: ON ●: OFF ◐: Blink

Error Code	Confirmation of Error 1							Confirmation of Error 2							Confirmation of Error 3							Confirmation of Error 4						
	H1P	H2P	H3P	H4P	H5P	H6P	H7P	H1P	H2P	H3P	H4P	H5P	H6P	H7P	H1P	H2P	H3P	H4P	H5P	H6P	H7P	H1P	H2P	H3P	H4P	H5P	H6P	H7P
P1	◐	◐	●	◐	●	●	●	◐	●	○	●	●	●	◐	◐	○	●	●	●	●	●	◐	○	○	●	●	●	●
P4								◐	●	○	●	◐	●	●	◐	○	●	●	●	●	●	◐	○	○	●	●	●	●
U0	◐	◐	●	◐	●	●	◐	◐	●	○	●	●	●	●	◐	○	●	●	●	●	●	◐	○	○	●	●	●	◐
U2								◐	●	○	●	●	◐	●	◐	○	●	●	●	●	●	◐	○	○	●	●	●	●
U3								◐	●	○	●	●	◐	●	◐	○	●	●	●	●	●	◐	○	○	●	●	●	◐
U4								◐	●	○	●	◐	●	●	◐	○	●	●	●	●	●	◐	○	○	●	●	●	◐
U9								◐	●	○	◐	●	●	◐	◐	○	●	●	●	●	●	◐	○	○	●	●	●	◐
UA								◐	●	○	◐	●	◐	●	◐	○	●	●	●	●	●	◐	○	○	●	●	●	◐
UF								◐	●	○	◐	◐	◐	◐	◐	○	●	●	●	●	●	◐	○	○	●	●	●	◐
UH								◐	●	○	◐	●	◐	◐	◐	○	●	●	●	●	●	◐	○	○	●	●	●	◐

Display of error description (first digit)

Display of error description (second digit)

Display 1 of error in detail

Display 2 of error in detail

*1

●	●	Master
●	◐	Slave1
◐	●	Slave2
◐	◐	System

5. Troubleshooting by Error Codes

5.1 Error Codes and Description

○: ON ●: OFF◐: Blink

	Error code	Operation lamp	Description	Reference Page
Indoor Unit	A0	●	External protection device abnormality	249
			External protection device abnormality (FTQ-TA only)	250
	A1	●	Indoor unit PCB abnormality	251
	A3	●	Drain level control system (S1L) abnormality	252
	A6	●	Indoor fan motor (M1F) lock, overload	254
			Indoor fan motor abnormality	256
			Blower motor not running (FTQ-TA only)	262
			Indoor fan motor status abnormality (FTQ-TA only)	263
			Low indoor airflow (FTQ-TA only)	264
	A7★	○	Swing flap motor abnormality	265
	A8	●	Power supply voltage abnormality	267
			Blower motor stops for over/under voltage (FTQ-TA only)	268
	A9	●	Electronic expansion valve coil abnormality, dust clogging	269
	AF★	○	Drain level above limit	270
	AH	●	Self-cleaning decoration panel abnormality	271
	AJ	●	Defective capacity setting	282
	C1	●	Transmission abnormality (between indoor unit PCB and fan PCB)	283
			Blower motor communication error (FTQ-TA only)	285
	C4	●	Heat exchanger liquid pipe thermistor abnormality	286
	C5	●	Heat exchanger gas pipe thermistor abnormality	286
	C6	●	Combination abnormality (between indoor unit PCB and fan PCB)	287
			Blower motor HP mismatch (FTQ-TA only)	288
			Indoor blower does not have required parameters to function (FTQ-TA only)	289
	C9	●	Suction air thermistor abnormality	286
			Remote sensor abnormality	290
	CA	○	Discharge air thermistor abnormality	286
CE★	○	Infrared presence/floor sensor error	291	
CJ (*1)	○	Remote controller thermistor abnormality	296	

	Error code	Operation lamp	Description	Reference Page
Outdoor Unit	E1	●	Outdoor main PCB abnormality	297
	E3	●	Activation of high pressure switch	298
	E4	●	Activation of low pressure sensor	300
	E5	●	Compressor motor lock	302
	E7	●	Outdoor fan motor abnormality	304
	E9	●	Electronic expansion valve coil abnormality	306
	F3	●	Discharge pipe temperature abnormality	307
	F6	●	Refrigerant overcharged	308
	H9	●	Outdoor air thermistor abnormality	309
	J3	●	Discharge pipe thermistor abnormality	309
	J5	●	Suction pipe thermistor abnormality	309
	J6	●	Outdoor heat exchanger deicer thermistor abnormality	309
	J7	●	Outdoor heat exchanger liquid pipe thermistor abnormality	309
	J9	●	Subcooling heat exchanger gas pipe thermistor abnormality	309
	JA	●	High pressure sensor abnormality	310
	JC	●	Low pressure sensor abnormality	311
	L1	●	Inverter PCB abnormality	312
	L4	●	Radiation fin temperature rise abnormality	313
	L5	●	Compressor instantaneous overcurrent	314
	L8	●	Compressor overcurrent	315
	L9	●	Compressor startup abnormality	316
	LC	●	Transmission error between microcomputers on outdoor unit main PCB	317
	P1	●	Inverter circuit capacitor high voltage	318
P4★	○	Radiation fin thermistor abnormality	319	
System	U0★	○	Refrigerant shortage	320
	U2	●	Power supply insufficient or instantaneous abnormality	322
	U3	●	Check operation not executed	324
	U4	●	Transmission error between indoor units and outdoor units	325
	U5	●	Transmission error between remote controller and indoor unit	327
	U8	●	Transmission error between main and sub remote controllers	328
	U9	●	Transmission error between indoor and outdoor units in the same system	329
	UA	●	Improper combination of indoor and outdoor units, indoor units and remote controller	330
			Incorrect electric heater capacity setting (FTQ-TA only)	332
	UC★	○	Address duplication of centralized controller	333
	UE	●	Transmission error between centralized controller and indoor unit	334
	UF	●	System not set	335
	UH	●	System abnormality, refrigerant system address undefined	336

★: In the case of error codes identified, system operation continues, however, be sure to check and repair.



Note(s)

*1. The system may not continue operation depending on the conditions.

5.2 Error Codes - Sub Codes

If an error code like the one shown below is displayed when a wired remote controller is in use, make a detailed diagnosis.

5.2.1 Indoor Unit

Error code	Troubleshooting	
	Description of error	Description of diagnosis
A0 - 01	External protection device abnormality	Refer to page 250.
A6 - 01	Fan motor locked	A locked fan motor current has been detected. Turn the fan by hand to check for the connection of connectors.
A6 - 10	Fan overcurrent error	A fan motor overcurrent has been detected. Check for the connection of the connector between the fan motor and the fan PCB. If the connection is normal, replace the fan motor. If this still cannot solve the error, replace the fan PCB.
A6 - 11	Fan position detection error	An error in the detection of position of the fan motor. Check for the connection of the connector between the fan motor and the fan PCB. If the connection is normal, replace the fan motor. If this still cannot solve the error, replace the fan PCB.
A6 - 20	Indoor fan motor status abnormality	Refer to page 263.
A6 - 21	Low indoor airflow	Refer to page 264.
A8 - 01	Power supply voltage error	Check for the input voltage of the fan motor.
A9 - 01	Electronic expansion valve error	There is an error in the electronic expansion valve coil or a connector disconnected.
A9 - 02	Refrigerant leakage detection error	Refrigerant leaks even if the electronic expansion valve is closed. Replace the electronic expansion valve.
AH - 03	Transmission error (between the self-cleaning decoration panel and the indoor unit) (when the self-cleaning decoration panel is mounted)	Check for the connection of the harness connector between the panel PCB and the indoor unit PCB.
AH - 04	Dust detection sensor error (when the self-cleaning decoration panel is mounted)	Check for the connections of the connector X12A on the panel PCB and the connectors X18A and X19A on the sensor PCB.
AH - 05	Dust collection sign error (when the self-cleaning decoration panel is mounted)	Check for clogging with dust at the dust collection port as well as in the brush unit, S-shaped pipe, and dust box. Furthermore, check for any stains of the light receiving and emitting parts of the infrared unit.
AH - 06	Air filter rotation error (when the self-cleaning decoration panel is mounted)	Check for anything getting in the way of rotating the filter (e.g. the filter comes off or the drive gear is clogged with foreign matter).
AH - 07	Damper rotation error (when the self-cleaning decoration panel is mounted)	The damper does not rotate normally. Check for any foreign matter around the damper and for the operation of the gear and limit switch.
AH - 08	Filter auto clean operation error (when the self-cleaning decoration panel is mounted)	The unit has not yet completed the filter auto clean operation even after the lapse of specified period of time. Check for any external noise, etc.
AH - 09	Filter auto clean operation start disabled error (when the self-cleaning decoration panel is mounted)	The unit has been put into a state in which the filter auto clean operation is disabled. Check the unit for the operating conditions.
AJ - 01	Capacity setting error	There is an error in the capacity setting of the indoor unit PCB.
AJ - 02	Electronic expansion valve setting error	There is a fault in the setting of the gear type electronic expansion valve/direct acting type electronic expansion valve.
C1 - 01	Transmission abnormality between indoor unit PCB and fan PCB	Check for the conditions of transmission between the indoor unit PCB and the fan PCB.
C1 - 07	Blower motor communication error	Refer to page 285.
C6 - 01	Defective combination of indoor unit PCB and the fan PCB	A combination of indoor unit PCB and the fan PCB is defective. Check whether the capacity setting adaptor is correct and the type of the fan PCB is correct.
	Blower motor HP mismatch	Refer to page 288.
C6 - 02	Indoor blower does not have required parameters to function	Refer to page 289.
U4 - 01	Indoor-outdoor transmission error	Refer to the U4 flowchart.
UA - 13	Refrigerant type error	The type of refrigerant used for the indoor unit is different from that used for the outdoor unit.
UA - 15	Not applicable for self-cleaning decoration panel [when the self-cleaning decoration panel is mounted]	An outdoor unit is not applicable for the self-cleaning decoration panel is connected.
UA - 17	Incorrect electric heater capacity setting	Refer to page 332.

5.3 External Protection Device Abnormality (Except FTQ-TA)

Error Code	A0
Applicable Models	All indoor models (except FTQ-TA)
Method of Error Detection	Detect open or short circuit between external input terminals in indoor unit.
Error Decision Conditions	When an open circuit occurs between external input terminals with the remote controller set for external ON/OFF terminal.
Supposed Causes	<ul style="list-style-type: none"> ■ Activation of external protection device ■ Improper field setting ■ Defective indoor unit PCB
Troubleshooting	

**Caution**

Be sure to turn off the power switch before connecting or disconnecting connectors, or parts may be damaged.

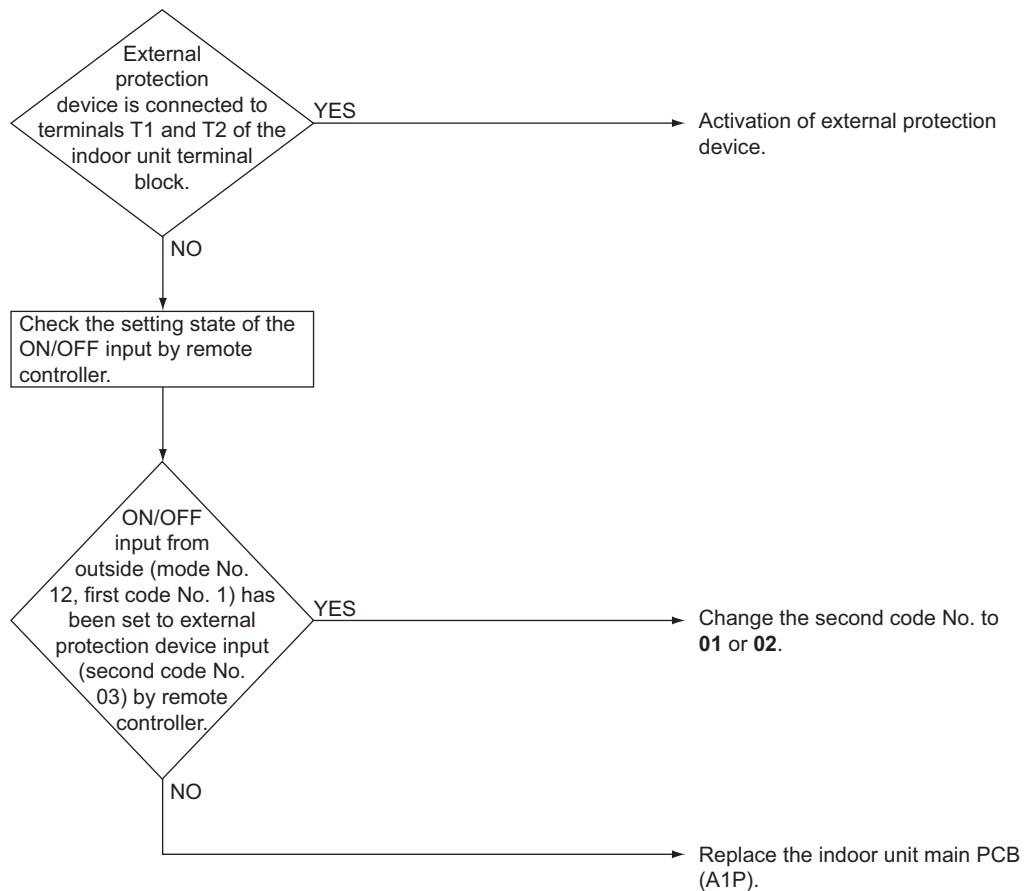

5.4 External Protection Device Abnormality (FTQ-TA Only)

Error Code	A0-01
Applicable Models	FTQ-TA
Method of Error Detection	Detect open or short circuit between external input terminals in indoor unit.
Error Decision Conditions	When an open circuit occurs between external input terminals.
Supposed Causes	<ul style="list-style-type: none"> ■ Activation of external protection device ■ Defective indoor unit PCB ■ Indoor unit fuse blown ■ 24 VAC power is not supplied to TH2 and TR2 terminals on the indoor unit PCB.

Troubleshooting



Caution Be sure to turn off the power switch before connecting or disconnecting connectors, or parts may be damaged.

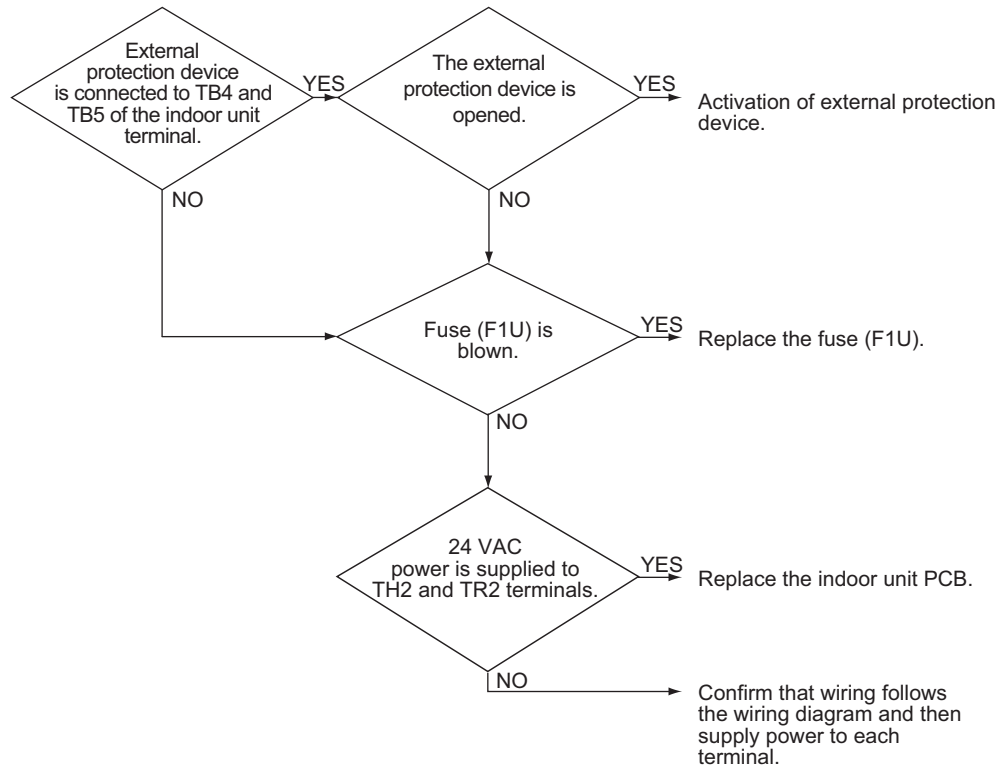

5.5 Indoor Unit PCB Abnormality

Error Code	A1
Applicable Models	All indoor models
Method of Error Detection	Data from EEPROM is checked.
Error Decision Conditions	When data cannot be correctly received from the EEPROM EEPROM: Type of nonvolatile memory. Maintains memory contents even when the power supply is turned OFF.
Supposed Causes	<ul style="list-style-type: none"> ■ Defective indoor unit PCB ■ External factor (Noise etc.)
Troubleshooting	

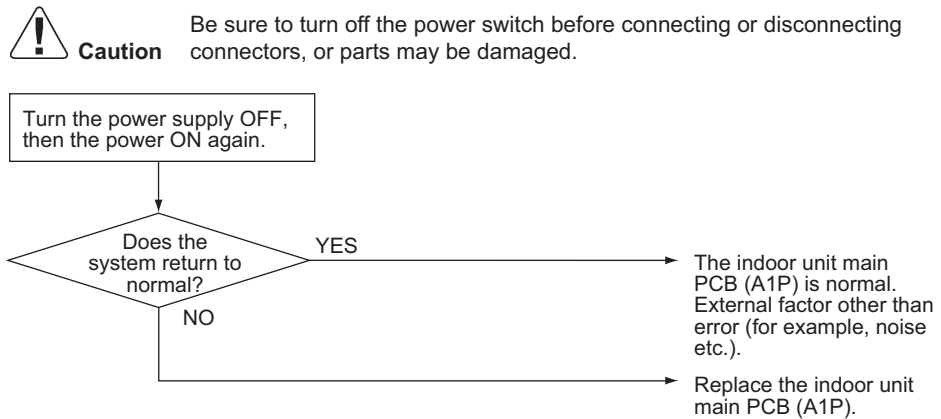

5.6 Drain Level Control System (S1L) Abnormality

Error Code	A3
Applicable Models	FCQ-TA, FCQ-AA, FBQ-P, FBQ-TB
Method of Error Detection	By float switch OFF detection
Error Decision Conditions	When the float switch goes OFF when conditions for rise of water level are not met
Supposed Causes	<ul style="list-style-type: none"> ■ Defective drain pump ■ Improper drain piping work ■ Drain piping clogging ■ Defective float switch ■ Defective indoor unit PCB ■ Defective short circuit connector on PCB

Troubleshooting



Caution Be sure to turn off the power switch before connecting or disconnecting connectors, or parts may be damaged.

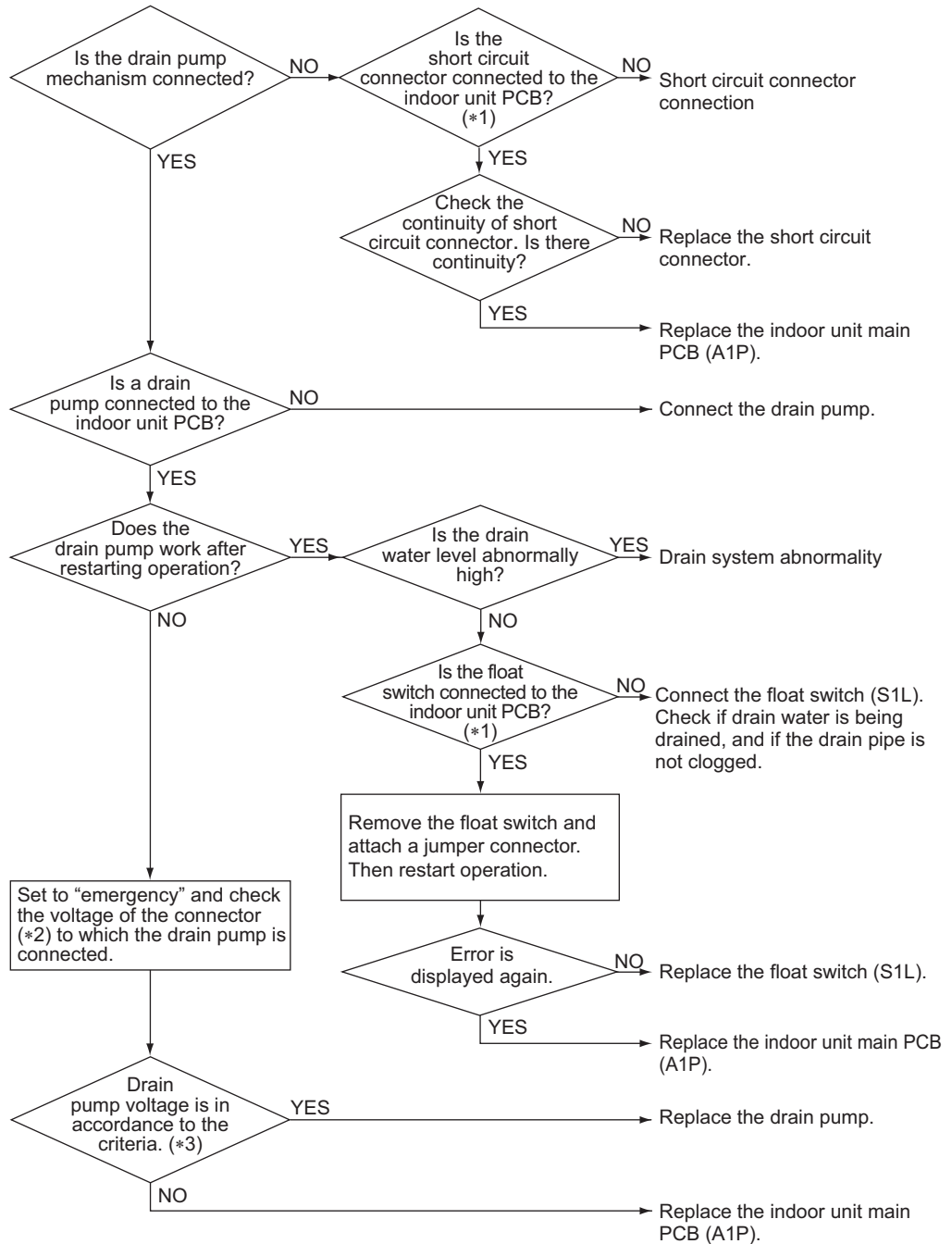

i Note(s)

Model	*1: Float switch (S1L) / short circuit connector	*2: Drain pump (M1P) connector	*3: Drain pump (M1P) voltage
FCQ-TA	X15A	X10A	13 VDC
FCQ-AA	X15A	X25A	13 VDC
FBQ-P	X15A	X25A	220-240 VAC
FBQ-TB	X15A	X25A	13 VDC

Note: If a PCB that does not have X15A connector detects **A3** error code, the PCB is defective.

5.7 Indoor Fan Motor (M1F) Lock, Overload

Error Code	A6
Applicable Models	FCQ-TA, FAQ-TA, FBQ18/24TB
Method of Error Detection	Abnormal fan revolutions are detected by signal output from the fan motor.
Error Decision Conditions	When the fan revolutions do not increase
Supposed Causes	<ul style="list-style-type: none"> ■ Broken wires in, short circuit of, or disconnection of connectors from the fan motor harness ■ Defective fan motor (Broken wires or defective insulation) ■ Abnormal signal output from the fan motor (defective circuit) ■ Defective indoor unit main PCB ■ Instantaneous disturbance in the power supply voltage ■ Fan motor lock (Due to motor or external causes) ■ The fan does not rotate due to foreign matter blocking the fan. ■ Disconnection of the connector between the indoor unit PCB (A1P) and the fan PCB (A2P) (FBQ18/24TB only) ■ Blowout of the fuse connected between the indoor unit PCB and the fan motor harness (FAQ-TA only)

Troubleshooting



Caution Be sure to turn off the power switch before connecting or disconnecting connectors, or parts may be damaged.

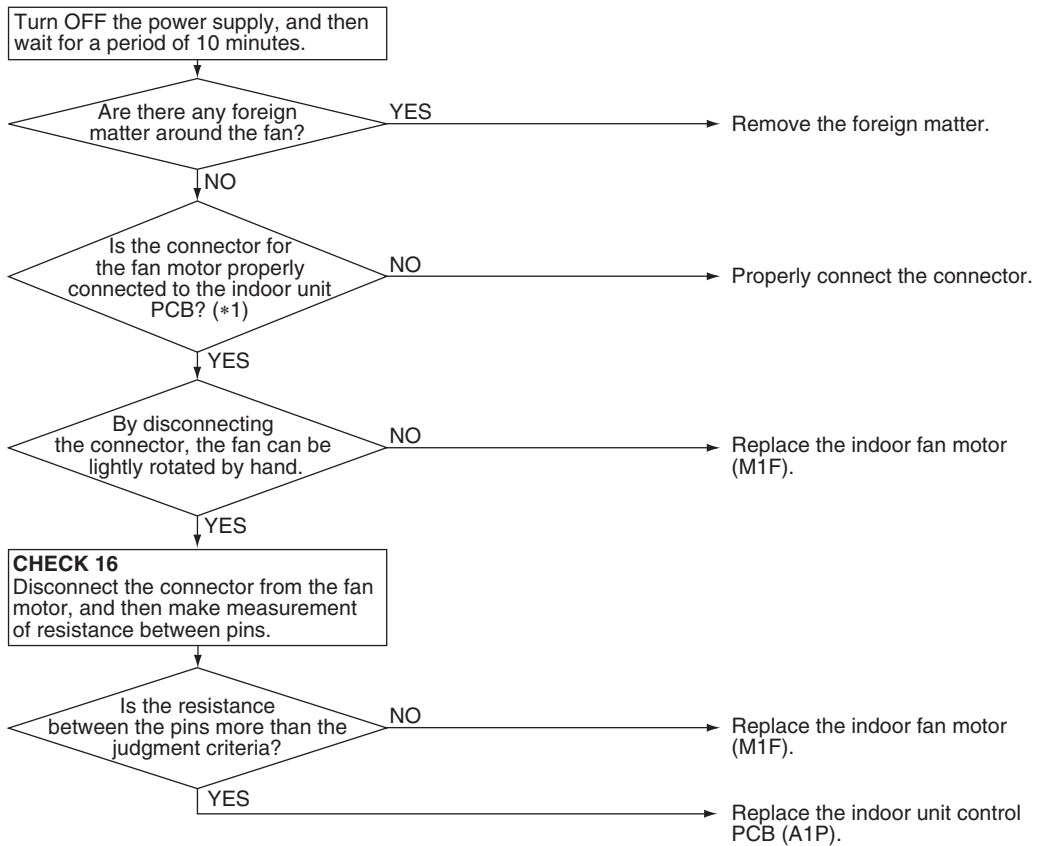

Note(s)

*1. Check the following connectors.

Model	Connector	PCB
FCQ-TA	X20A, Relay connector	A1P
FAQ-TA	X20A	A1P
FBQ18/24TB	X8A	A2P



Reference

CHECK 16 Refer to page 353.

5.8 Indoor Fan Motor Abnormality

5.8.1 Indoor Fan Motor Abnormality (FCQ-AA Models)

Error Code	A6
Applicable Models	FCQ-AA
Method of Error Detection	<ul style="list-style-type: none"> ■ Detection from the current flow on the PCB (A1P) ■ Detection from the current flow on the PCB when the fan motor starting operation
Error Decision Conditions	<ul style="list-style-type: none"> ■ An overcurrent flows ■ The rotation speed is less than a certain level for 6 seconds. ■ A position error in the fan rotor continues for 5 seconds or more.
Supposed Causes	<ul style="list-style-type: none"> ■ Fan does not rotate due to clogged foreign matter. ■ Disconnection, short circuit, or loose connection of the harness of the fan motor ■ Fan motor lock (motor-related or external factors) ■ Defective fan motor (disconnection or insulation failure) ■ Defective indoor unit PCB

Troubleshooting

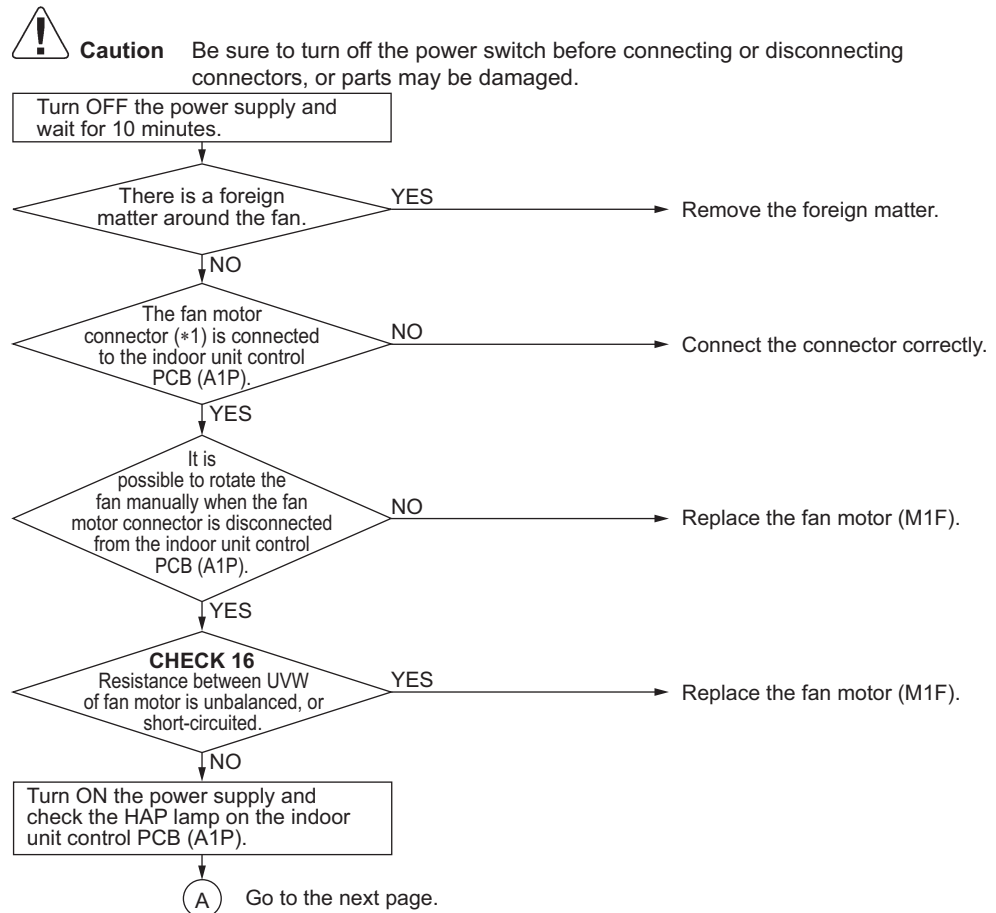

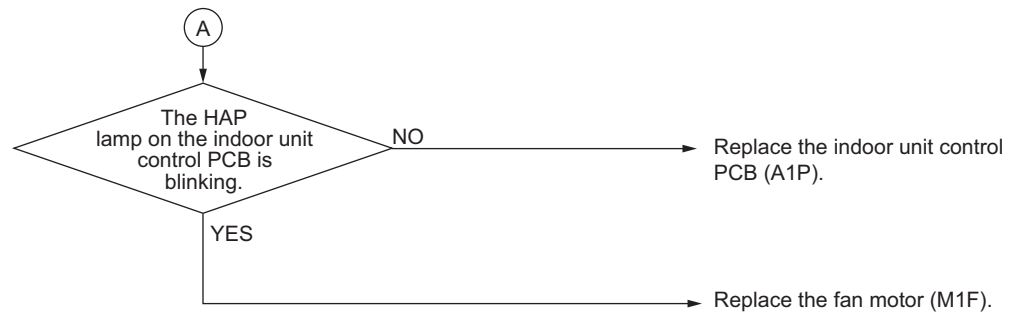

*1. Check also if the relay connector between the indoor unit control PCB and the fan motor are correctly connected.



Reference

CHECK 16 Refer to page 353.

5.8.2 Indoor Fan Motor Abnormality (FHQ-P, FHQ-M Models)

Error Code	A6
Applicable Models	FHQ-P, FHQ-M
Method of Error Detection	This error is detected if there is no revolution detection signal output from the fan motor.
Error Decision Conditions	When no revolutions can be detected even at the maximum output voltage to the fan
Supposed Causes	<ul style="list-style-type: none"> ■ Defective indoor fan motor ■ Broken wires ■ Defective contact.

Troubleshooting



Caution

Be sure to turn off the power switch before connecting or disconnecting connectors, or parts may be damaged.

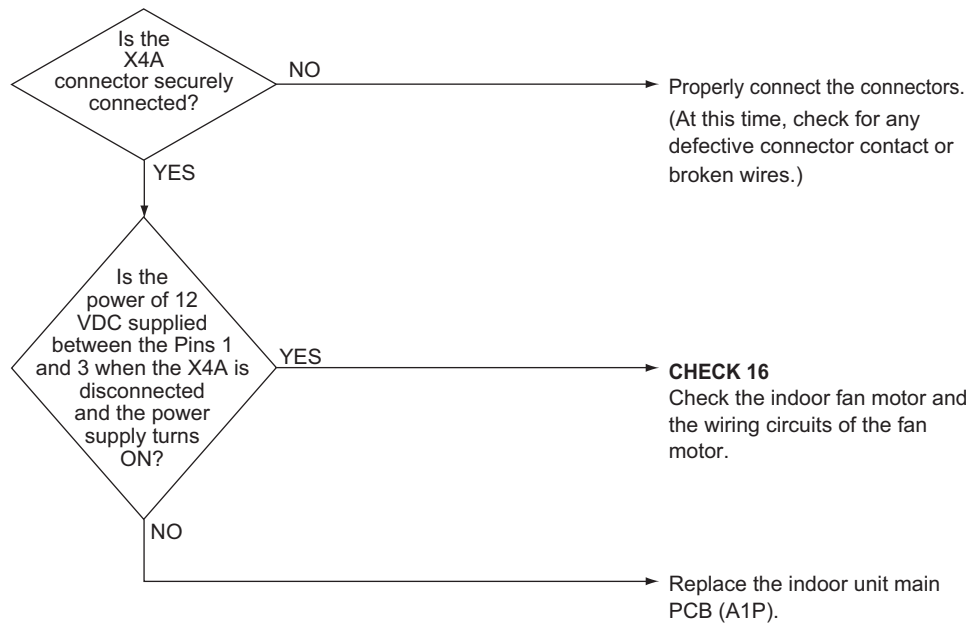

Reference

CHECK 16 Refer to page 353.

5.8.3 Indoor Fan Motor Abnormality (FBQ-P, FBQ30-48TB Models)

Error Code	A6
Applicable Models	FBQ-P, FBQ30-48TB
Method of Error Detection	Error from the current flow on the fan PCB Error from the rotation speed of the fan motor in operation Error from the position signal of the fan motor Error from the current flow on the fan PCB when the fan motor starting operation
Error Decision Conditions	<ul style="list-style-type: none"> ■ An overcurrent flows. ■ The rotation speed is less than a certain level for 6 seconds. ■ A position error in the fan rotor continues for 5 seconds or more.
Supposed Causes	<ul style="list-style-type: none"> ■ Clogging of a foreign matter ■ Disconnection of the fan motor connectors (X1A and X2A) ■ Disconnection of the connectors between the indoor unit PCB (A1P) and fan PCB (A2P) ■ Defective fan PCB (A2P) ■ Defective fan motor

Troubleshooting



Caution Be sure to turn off the power switch before connecting or disconnecting connectors, or parts may be damaged.

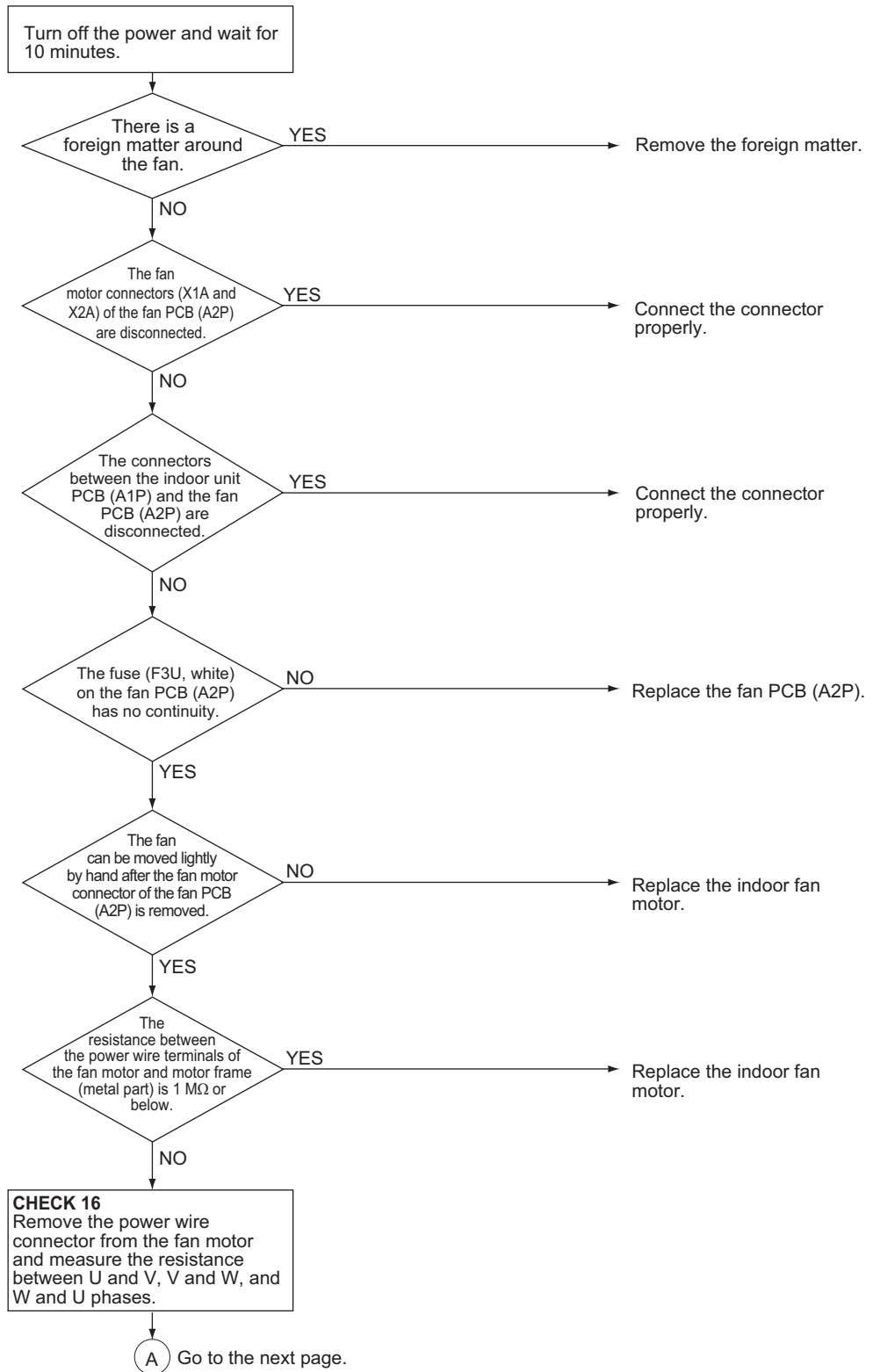

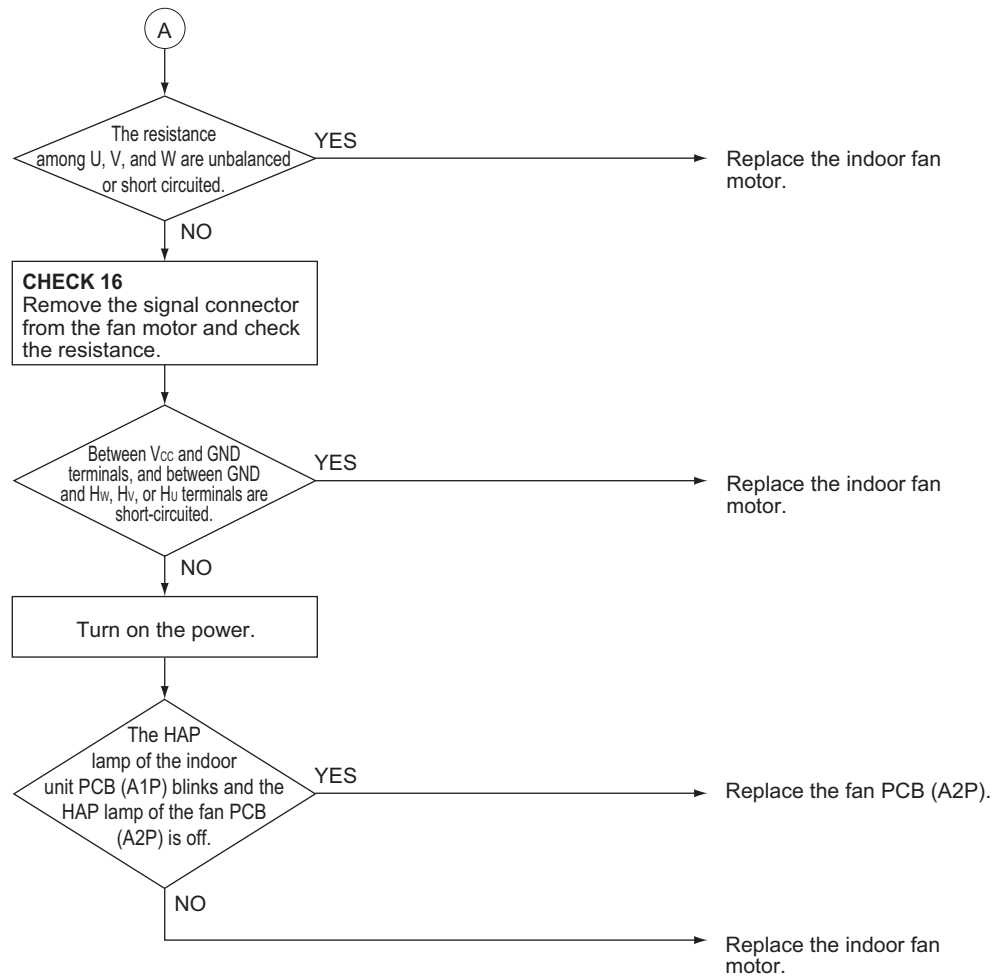

Reference CHECK 16 Refer to page 353.

5.9 Blower Motor Not Running

Error Code	A6
Applicable Models	FTQ-TA
Outline	Error is issued if the indoor unit determines that the indoor fan motor cannot rotate.
Error Decision Conditions	<ul style="list-style-type: none"> ■ Determining successive abnormalities Checks the rotation speed at 5-second intervals using the feedback of the fan motor. If that figure falls below 50 rpm 5 times successively, it is deemed abnormal operation. If, during operation, the rotation command is stopped, the 5-second interval check is halted and the counted number will be cleared. ■ Determining long-term abnormalities Checks the rotation speed at 5-second intervals using the feedback of the fan motor. Performs rotation sampling 720 times (takes approx. one hour), and if the rotation speed falls below 50 rpm over 100 times, it is deemed abnormal operation. When the sampling reaches 720 times, the counted number will be cleared and the 720 times sampling restarts. If, during this, the rotation command is stopped, the 5-second interval check is halted, but the counted number will be kept. When the rotation command is restarted, the checks will resume.
Error Reset Conditions	Reset by remote controller
Supposed Causes	<ul style="list-style-type: none"> ■ Fan or motor obstruction ■ Power interruption (low voltage) ■ Incorrect or loose wiring
Corrective Actions	<ul style="list-style-type: none"> ■ Check for obstruction on the fan or motor. ■ Verify the input voltage at the motor. ■ Check wiring or tighten wiring connections if needed. ■ Replace the indoor unit PCB or motor.



Reference

CHECK 19 Refer to page 358.

5.10 Indoor Fan Motor Status Abnormality

Error Code	A6-20
Applicable Models	FTQ-TA
Outline	The indoor unit periodically receives control status information from the fan motor. Error is issued when the information shows abnormality.
Error Decision Conditions	If the information shows Power Limit or Temp Limit status, it will be deemed a MOTOR LIMIT abnormal operation. (The system can keep operating.) If the information shows Motor Lost Control or Current Trip status, it will be deemed a MOTOR TRIP abnormal operation. (The system stops operating.)
Error Reset Conditions	If the indoor unit stops receiving abnormal information, the error will be cleared.
Supposed Causes	<ul style="list-style-type: none"> ■ Fan or motor obstruction ■ Blocked filters ■ Power interruption (low voltage) ■ Incorrect wiring ■ Blockage in the airflow (ductwork) or ductwork undersized ■ High loading conditions
Corrective Actions	<ul style="list-style-type: none"> ■ Check for obstruction on the fan, motor, or ductwork. ■ Clean filters. ■ Check filters, grille, duct system, heat exchanger air inlet/outlet for blockages. ■ Verify the input voltage at the motor. ■ Check wiring. ■ Replace motor.
 Reference	CHECK 19 Refer to page 358.

5.11 Low Indoor Airflow

Error Code	A6-21
Applicable Models	FTQ-TA
Outline	Error is issued if the indoor unit determines that the indoor fan motor rotation is insufficient, regardless of the rotation command from indoor unit.
Error Decision Conditions	<ul style="list-style-type: none"> ■ Determining successive abnormalities Checks the rotation speed at 5-second intervals using the feedback of the fan motor. If that figure exceeds 50 rpm and falls below 150 rpm 10 times successively, it is deemed abnormal operation. If, during operation, the rotation command is stopped, the 5-second interval check is halted and the counted number will be cleared. ■ Determining long-term abnormalities Checks the rotation speed at 5-second intervals using the feedback of the fan motor. Performs rotation sampling 720 times (takes approx. one hour), and if the rotation speed exceeds 50 rpm and falls below 150 rpm over 360 times, it is deemed abnormal operation. When the counter reaches 720 times, the counted number will be cleared and the 720 times sampling restarts. If, during this, the rotation command is stopped, the 5-second interval check is halted, but the counted number will be kept. When the rotation command is restarted, the checks will resume.
Error Reset Conditions	<ul style="list-style-type: none"> ■ Determining successive abnormalities Checks the rotation speed at 5-second intervals using the feedback of the fan motor. If that figure exceeds 150 rpm even once, the error will be cleared. ■ Determining long-term abnormalities Checks the rotation speed at 5-second intervals using the feedback of the fan motor. If that figure exceeds 150 rpm 36 times successively, the error will be cleared. At that point, the counted number and sampling number will be cleared, and the 720 times sampling starts again from the beginning.
Supposed Causes	<ul style="list-style-type: none"> ■ Fan or motor obstruction ■ Blocked filters ■ Restrictive ductwork or ductwork undersized ■ Wiring disconnected ■ Wrong outdoor and indoor combination ■ Indoor fan motor failure
Corrective Actions	<ul style="list-style-type: none"> ■ Check for obstruction on the fan or motor. ■ Check ductwork and filter for blockage. ■ Clean filters. ■ Remove obstruction. Verify all registers are fully open. ■ Check the connections and the rotation of the motor. ■ Verify the input voltage at the motor. ■ Verify ductwork is appropriately sized for system. Resize or replace ductwork if needed. ■ Replace motor.



Reference

CHECK 19 Refer to page 358.

5.12 Swing Flap Motor Abnormality

Error Code

A7

Applicable Models

FHQ-P, FHQ-M

Method of Error Detection

Utilizes ON/OFF of the limit switch when the motor turns.

Error Decision Conditions

When ON/OFF of the micro-switch for positioning cannot be reversed even though the swing flap motor is energized for a specified amount of time (about 30 seconds).

* Error code is displayed but the system operates continuously.

Supposed Causes

- Defective swing motor
- Defective connection cable (power supply and limit switch)
- Defective micro-switch
- Defective indoor unit main PCB

Troubleshooting



Caution Be sure to turn off the power switch before connecting or disconnecting connectors, or parts may be damaged.

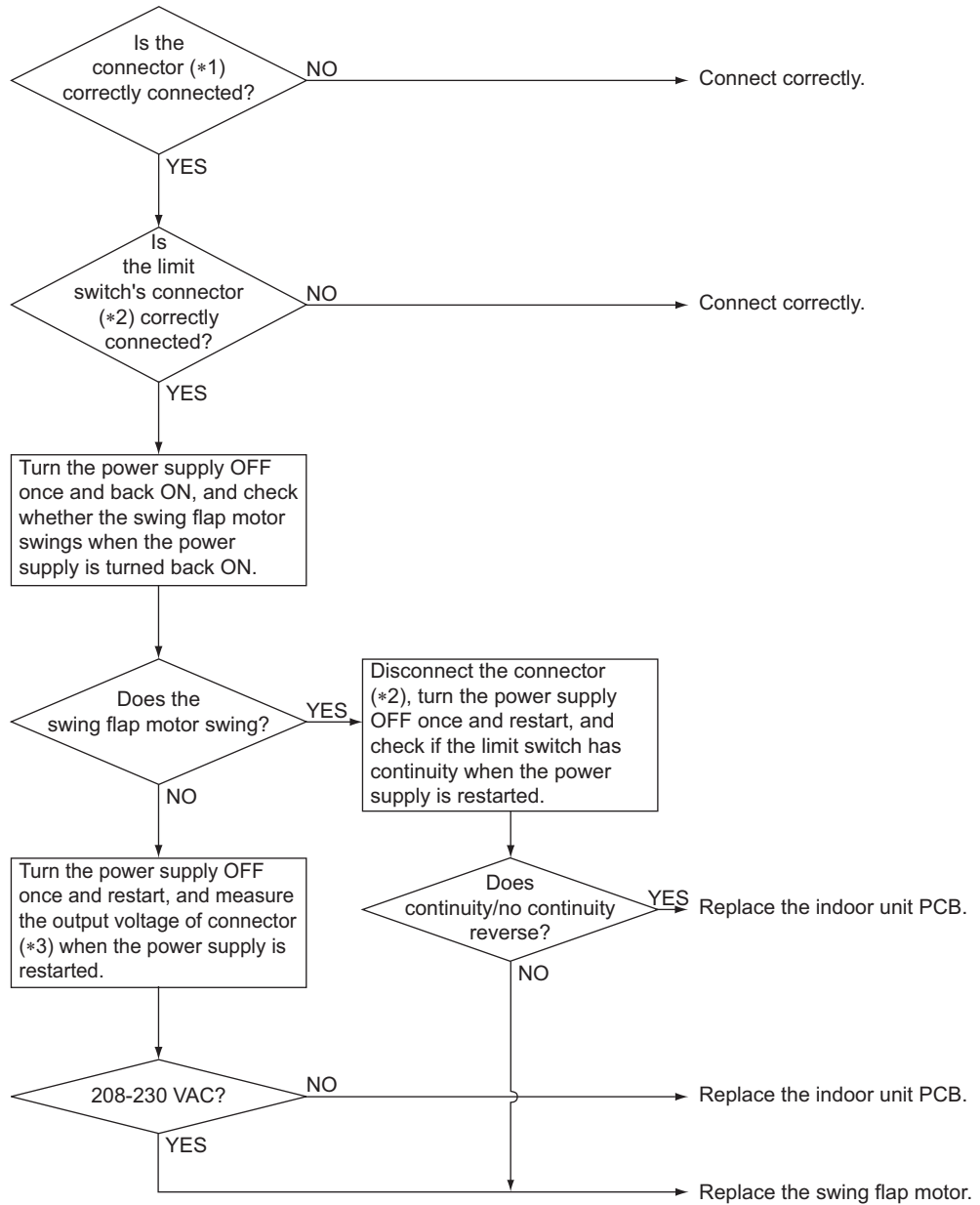

Note(s)

*1. Connector and indoor unit PCB

Model	Connector for swing flap motor			PCB
	*1	*2	*3	
FHQ	X6A, X9A	X9A	X6A	A1P

5.13 Power Supply Voltage Abnormality

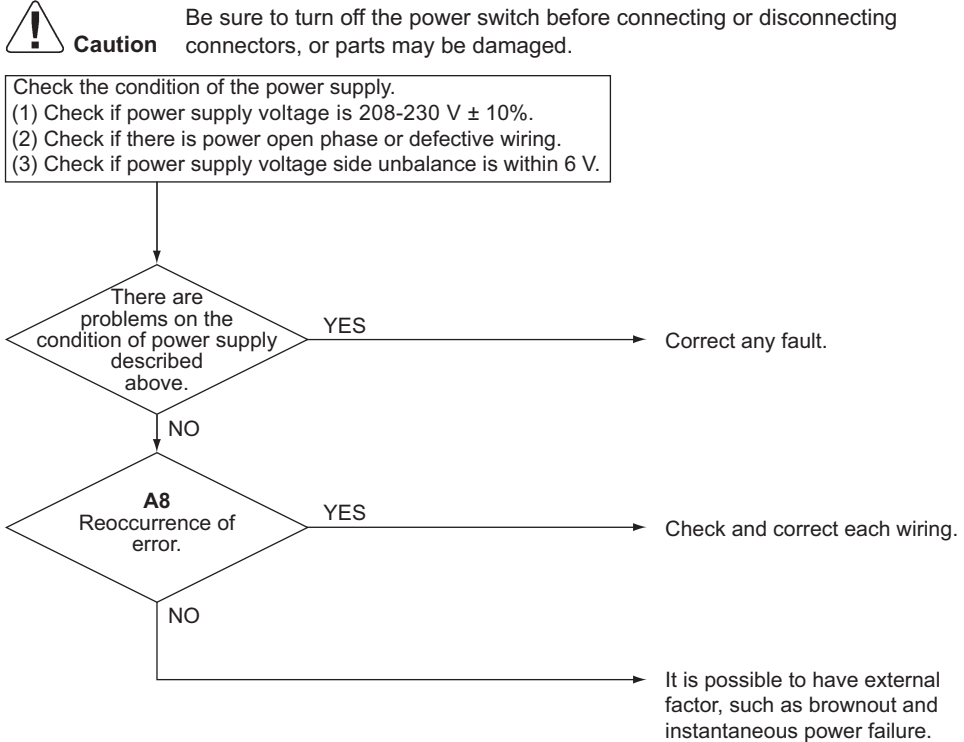
Error Code	A8
Applicable Models	FBQ-P, FBQ-TB
Method of Error Detection	Error is detected by checking the input voltage of the fan motor.
Error Decision Conditions	When the input voltage of fan motor is 150 V or less, or 386 V or more.
Supposed Causes	<ul style="list-style-type: none"> ■ Defective power supply voltage ■ Defective connection on signal line ■ Defective wiring ■ Instantaneous power failure, others
Troubleshooting	

Caution

Be sure to turn off the power switch before connecting or disconnecting connectors, or parts may be damaged.

Check the condition of the power supply.
 (1) Check if power supply voltage is 208-230 V \pm 10%.
 (2) Check if there is power open phase or defective wiring.
 (3) Check if power supply voltage side unbalance is within 6 V.

There are problems on the condition of power supply described above.

YES

Correct any fault.

NO

A8
Reoccurrence of error.

YES

Check and correct each wiring.

NO

It is possible to have external factor, such as brownout and instantaneous power failure.

5.14 Blower Motor Stops for Over/Under Voltage

Error Code	A8
Applicable Models	FTQ-TA
Outline	The indoor unit periodically receives control status information from the fan motor. Error is issued when the information shows abnormality.
Error Decision Conditions	If the information shows Over/Under Voltage status, it will be deemed a MOTOR VOLTS abnormal operation.
Error Reset Conditions	If the information is normal, the error will be cleared.
Supposed Causes	<ul style="list-style-type: none"> ■ High AC line voltage to indoor blower motor ■ Low AC line voltage to indoor blower motor ■ Incorrect wiring
Corrective Actions	<ul style="list-style-type: none"> ■ Verify line voltage to indoor blower motor is within the range specified on the ID blower rating plate. ■ Check power to indoor blower motor. ■ Check wiring. ■ Replace motor.

5.15 Electronic Expansion Valve Coil Abnormality, Dust Clogging

Error Code	A9
Applicable Models	All indoor models
Method of Error Detection	Electronic expansion valve coil conditions are checked via microcomputer. The electronic expansion valve main body is checked for dust clogging via microcomputer.
Error Decision Conditions	Pin input for electronic expansion valve coil is abnormal when initializing microcomputer. Either of the following conditions is seen/caused/occurs while the unit stops operation. <ul style="list-style-type: none"> ● R1T – R2T > 8°C (14.4°F) ● R2T shows fixed degrees or below. R1T: temperature of suction air R2T: temperature of liquid pipe of heat exchanger.
Supposed Causes	<ul style="list-style-type: none"> ■ Defective electronic expansion valve coil ■ Defective indoor unit main PCB ■ Defective relay cables

Troubleshooting

Caution

Be sure to turn off the power switch before connecting or disconnecting connectors, or parts may be damaged.

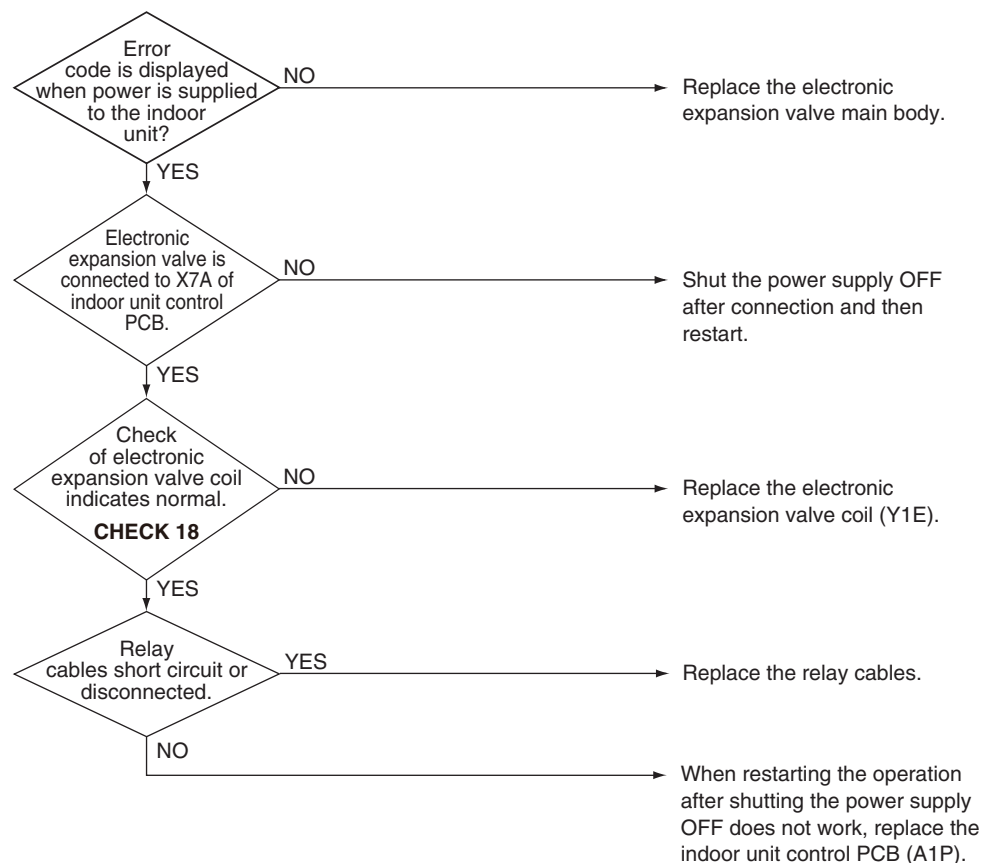
Reference
CHECK 18 Refer to page 355.

5.16 Drain Level Above Limit

Error Code	AF
Applicable Models	FCQ-TA, FCQ-AA, FBQ-P, FBQ-TB
Method of Error Detection	Water leakage is detected based on float switch ON/OFF operation while the compressor is not in operation.
Error Decision Conditions	When the float switch changes from ON to OFF while the compressor is not in operation. * Error code is displayed but the system operates continuously.
Supposed Causes	<ul style="list-style-type: none"> ■ Error in the drain pipe installation ■ Defective float switch ■ Defective indoor unit PCB ■ Defective connector connection ■ Defective drain pump

Troubleshooting



Caution

Be sure to turn off the power switch before connecting or disconnecting connectors, or parts may be damaged.

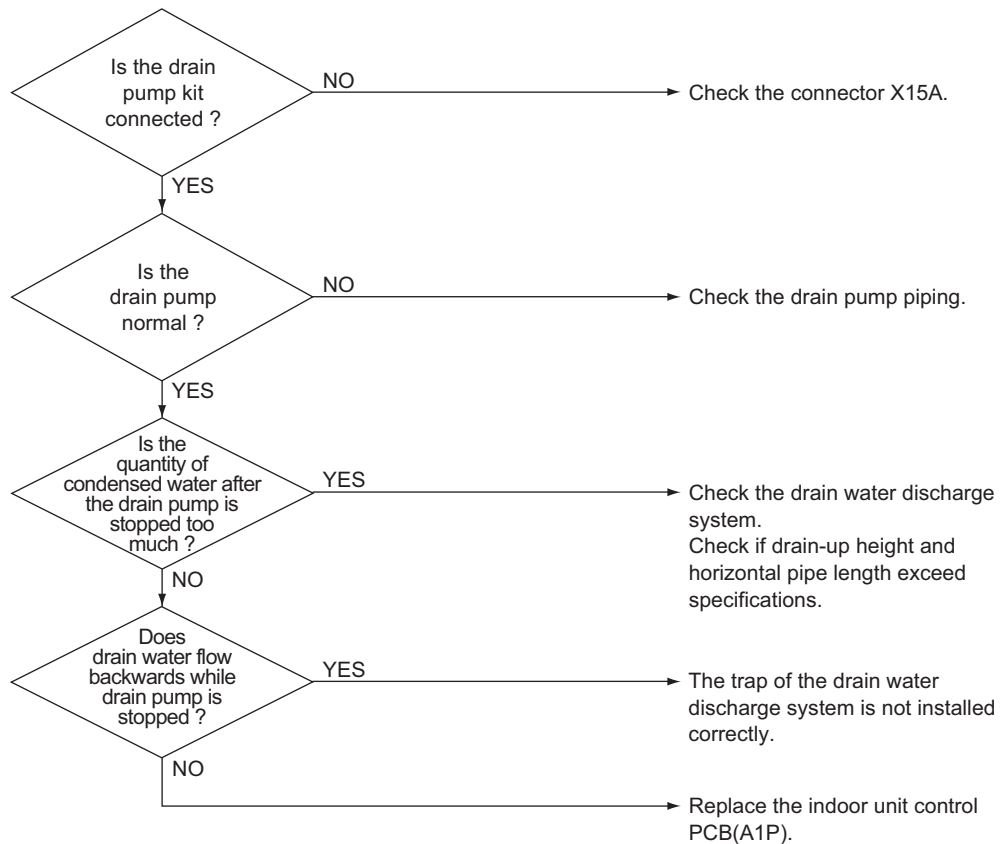

5.17 Self-Cleaning Decoration Panel Abnormality

Error Code	AH
Applicable Models	FCQ-TA (when self-cleaning decoration panel BYCQ125BGW1 is installed) FCQ-AA (when self-cleaning decoration panel BYCQ54EEGFU is installed)
Method of Error Detection	Error is detected by abnormal signal from the self-cleaning decoration panel.
Error Decision Conditions	Any of the following conditions is met while the unit is in operation. <ul style="list-style-type: none"> ■ There is a transmission error between self-cleaning decoration panel and indoor unit. ■ Dust detection sensor (light receiving side) is short-circuited. ■ The total of fan operation time exceeds a specified value after dust collection sign display. ■ Limit switch does not detect when air filter rotates or air filter does not rotate. ■ Limit switch does not detect when damper opens (or closes) or damper does not work. ■ Filter auto clean operation does not complete even after a specified time has elapsed. ■ Filter auto clean operation does not start even after a specified time has elapsed.
Supposed Causes	<ul style="list-style-type: none"> ■ Transmission error (between self-cleaning decoration panel and indoor unit) ■ Dust detection sensor error ■ Dust collection sign ■ Air filter rotation error ■ Damper rotation error ■ Filter auto clean operation error ■ Filter auto clean operation start disabled error

Troubleshooting



Caution

Be sure to turn off the power switch before connecting or disconnecting connectors, or parts may be damaged.

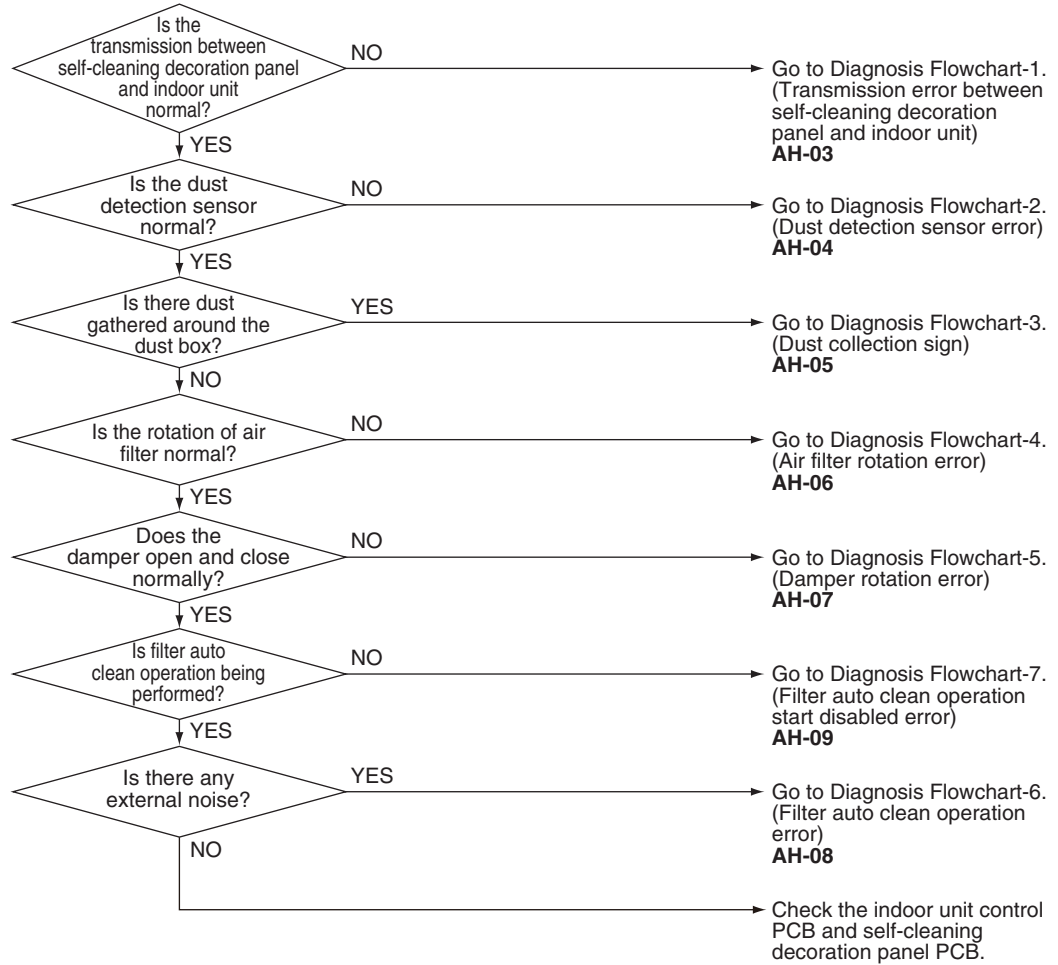

Reference

Refer to the diagnosis flowchart below.

Error code	Diagnosis Flowchart
AH-03	Diagnosis Flowchart-1 on page 273
AH-04	Diagnosis Flowchart-2 on page 274
AH-05	Diagnosis Flowchart-3 on page 275
AH-06	Diagnosis Flowchart-4 on page 276
AH-07	Diagnosis Flowchart-5 on page 278
AH-08	Diagnosis Flowchart-6 on page 280
AH-09	Diagnosis Flowchart-7 on page 281



Caution Be sure to turn off the power switch before connecting or disconnecting connectors, or parts may be damaged.

Diagnosis Flowchart-1

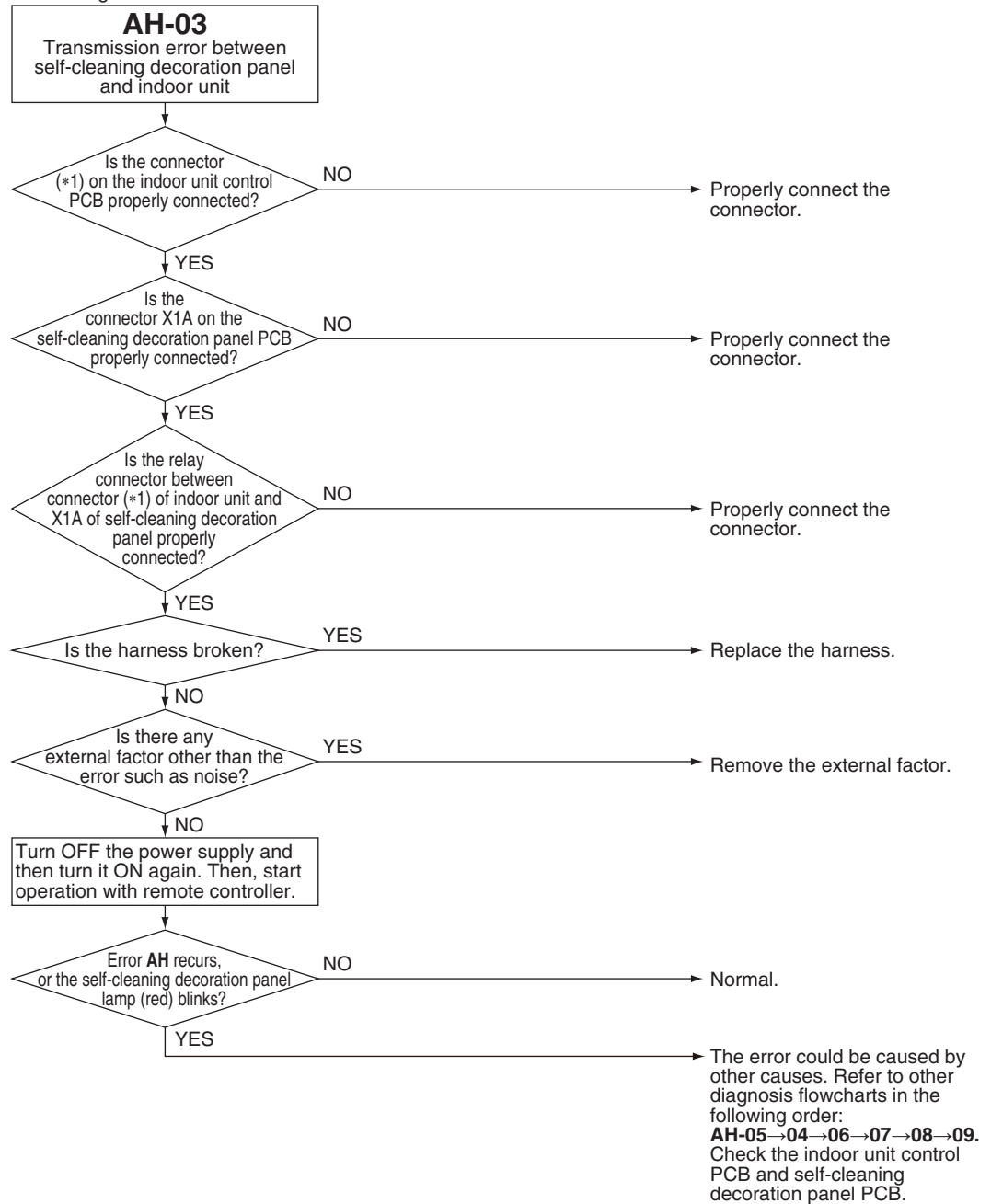

Note(s)

*1. Connector

Model	Connector
FCQ-TA	X8A
FCQ-AA	X70A



Caution Be sure to turn off the power switch before connecting or disconnecting connectors, or parts may be damaged.

Diagnosis Flowchart-2

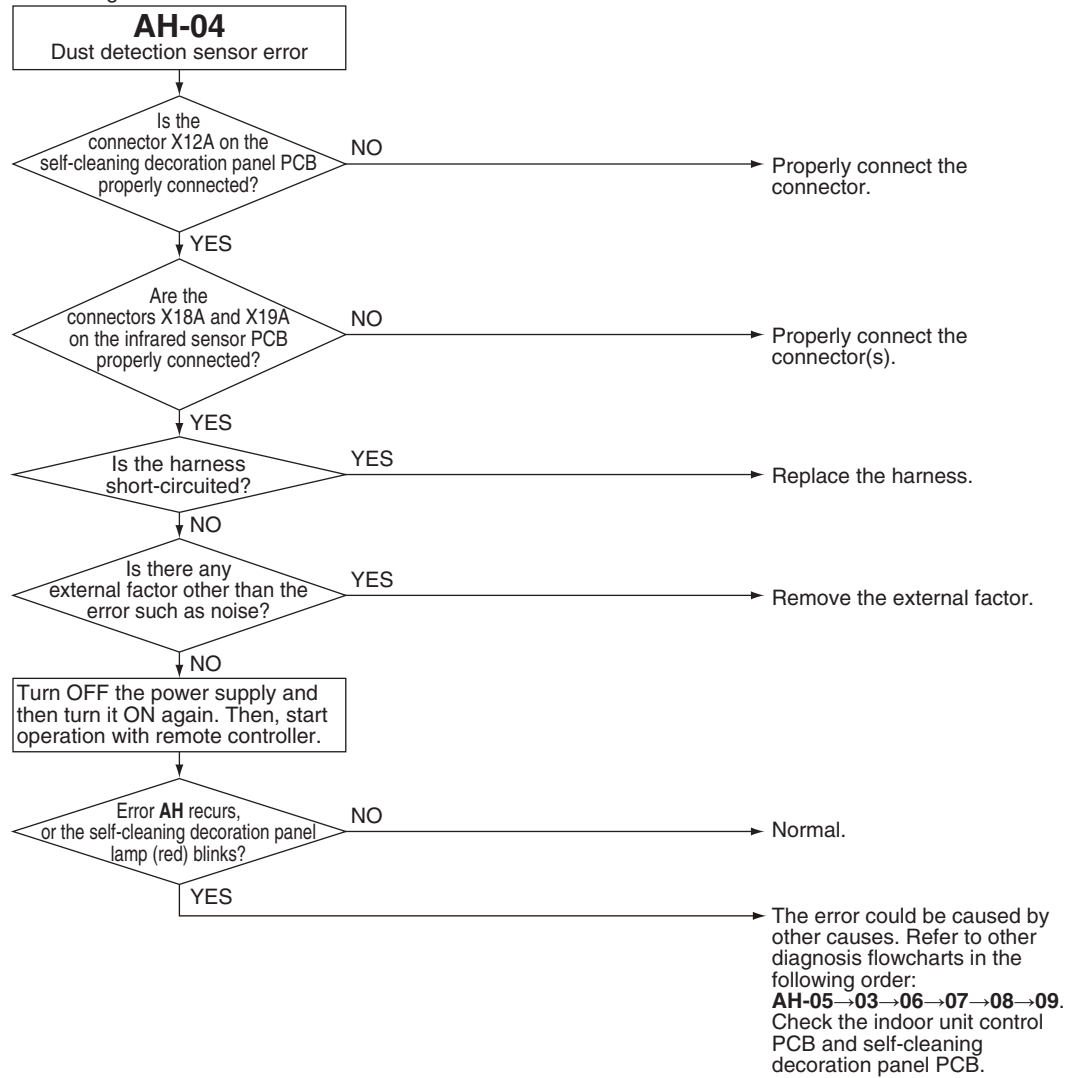

**Caution**

Be sure to turn off the power switch before connecting or disconnecting connectors, or parts may be damaged.

Diagnosis Flowchart-3

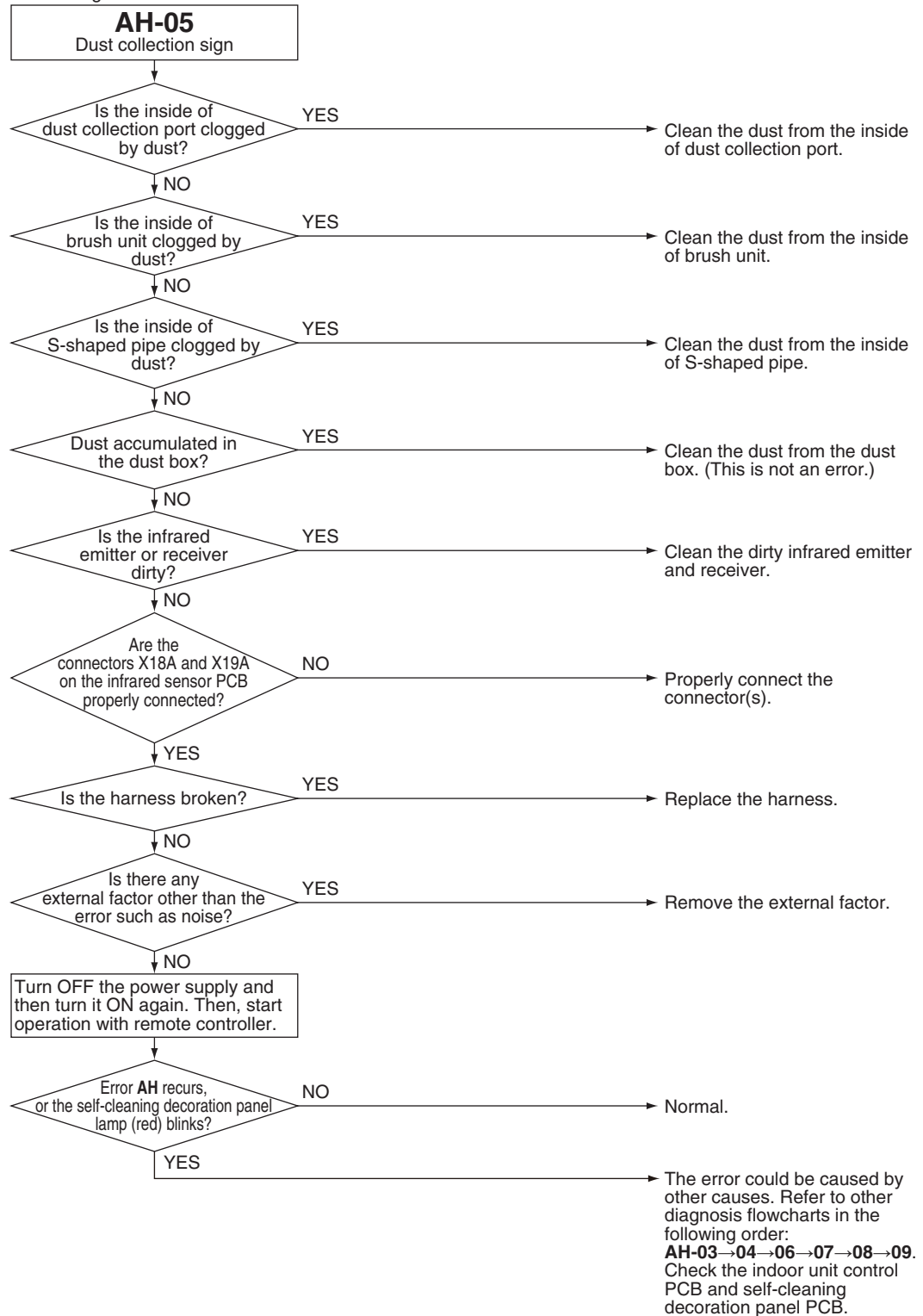



Caution

Be sure to turn off the power switch before connecting or disconnecting connectors, or parts may be damaged.

Diagnosis Flowchart-4

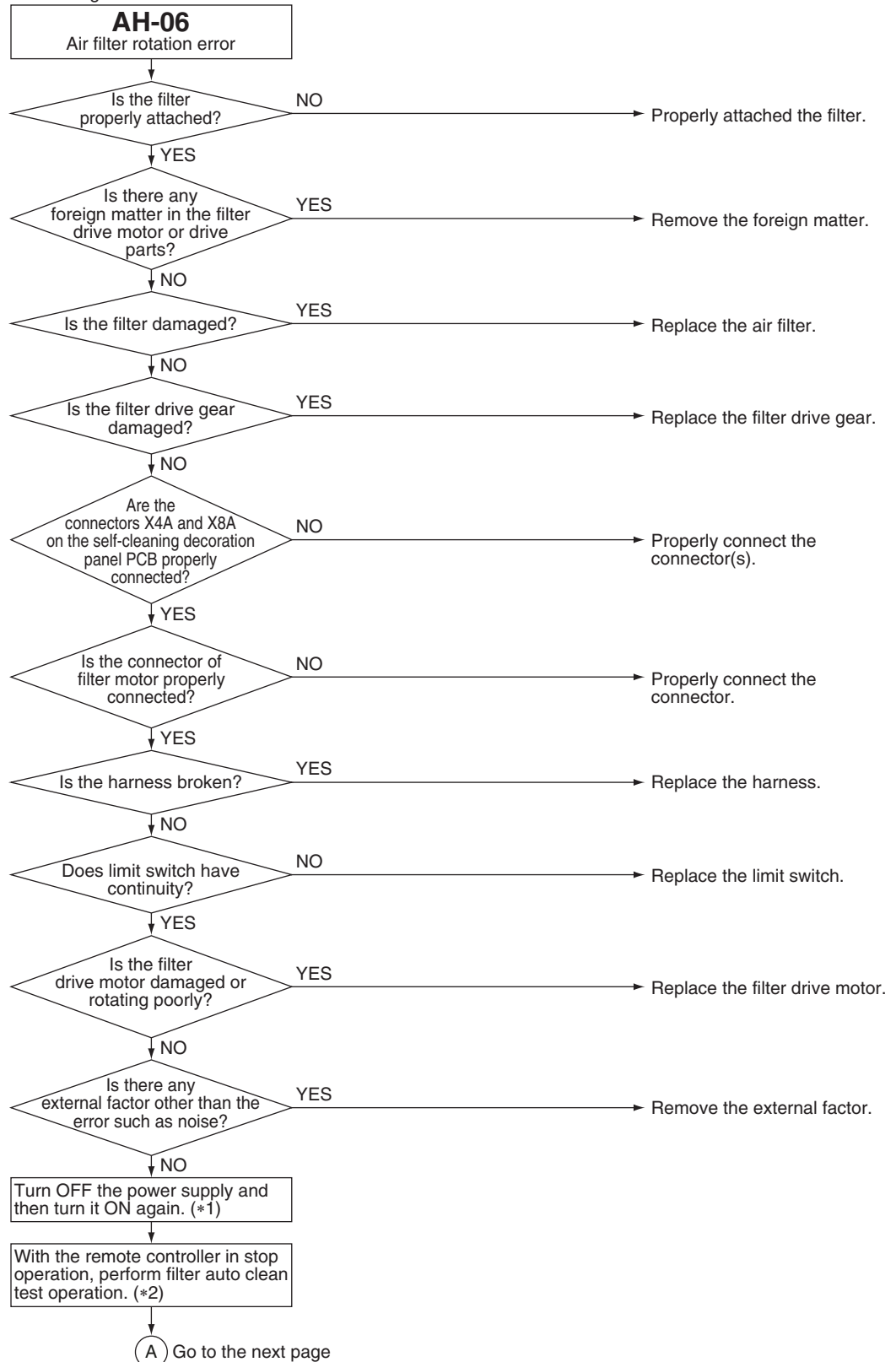

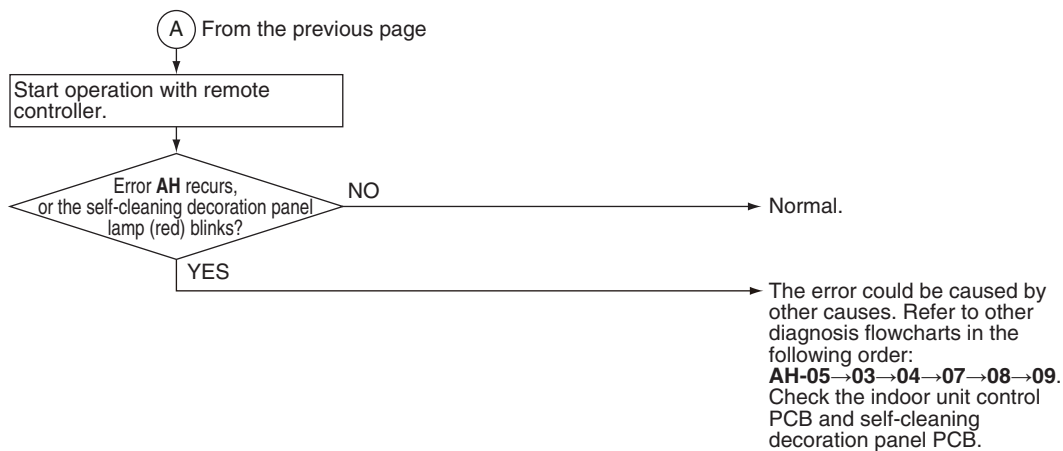

Note(s)

- *1. Temporary error code reset operation can be performed by pressing the push switch button **(BS2)** on the self-cleaning decoration panel PCB

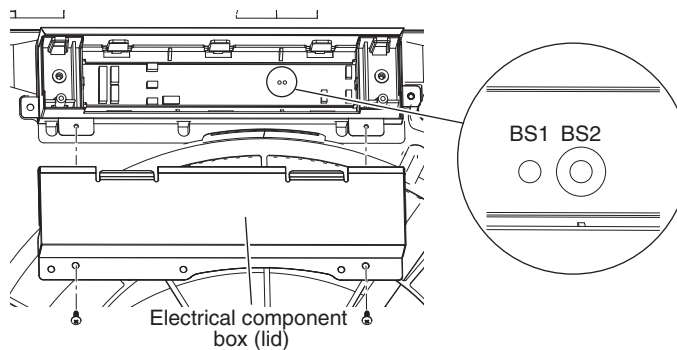

- *2. For details on performing filter auto clean test operation, refer to the operation manual of the self-cleaning decoration panel.



Caution

Be sure to turn off the power switch before connecting or disconnecting connectors, or parts may be damaged.

Diagnosis Flowchart-5

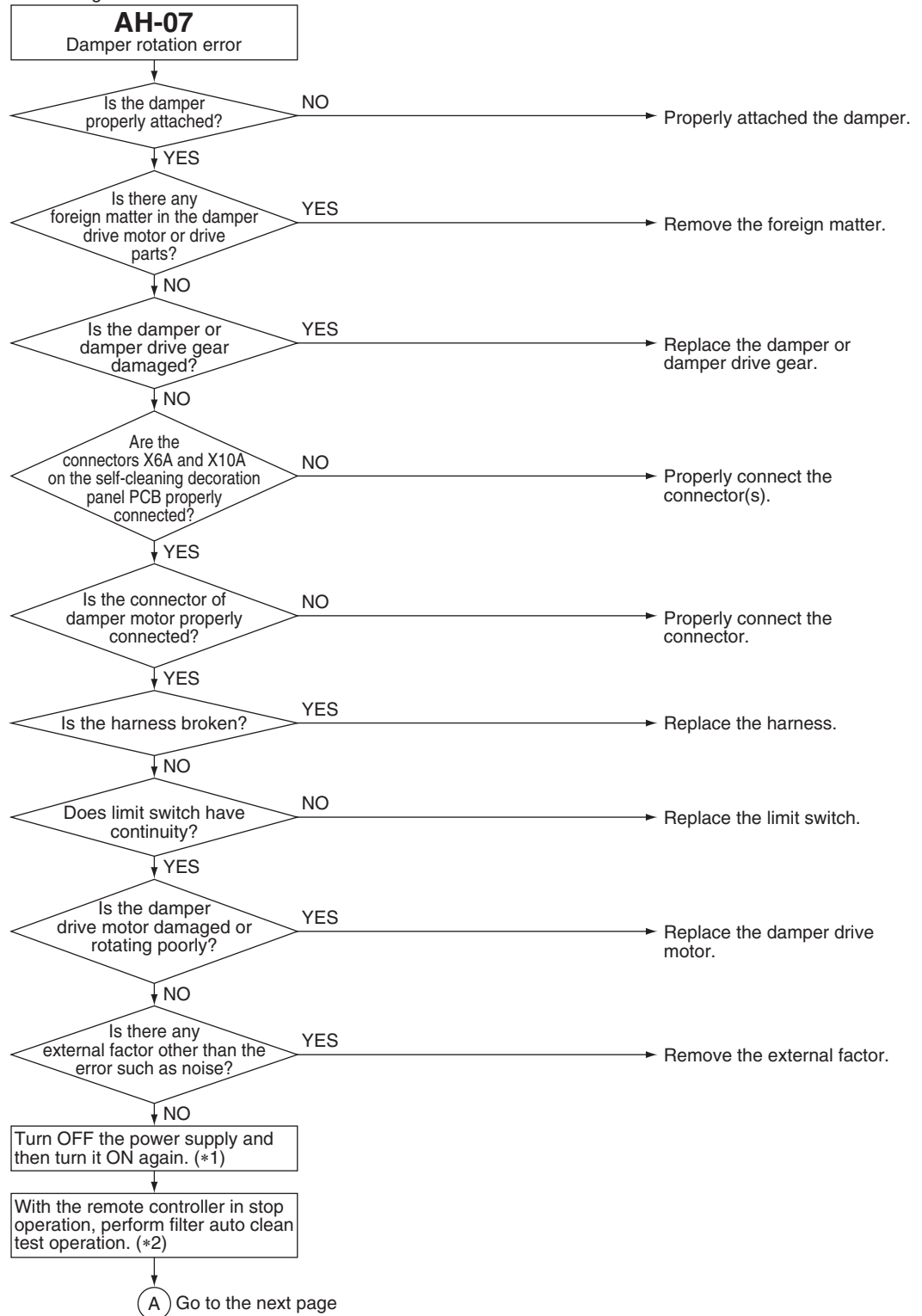

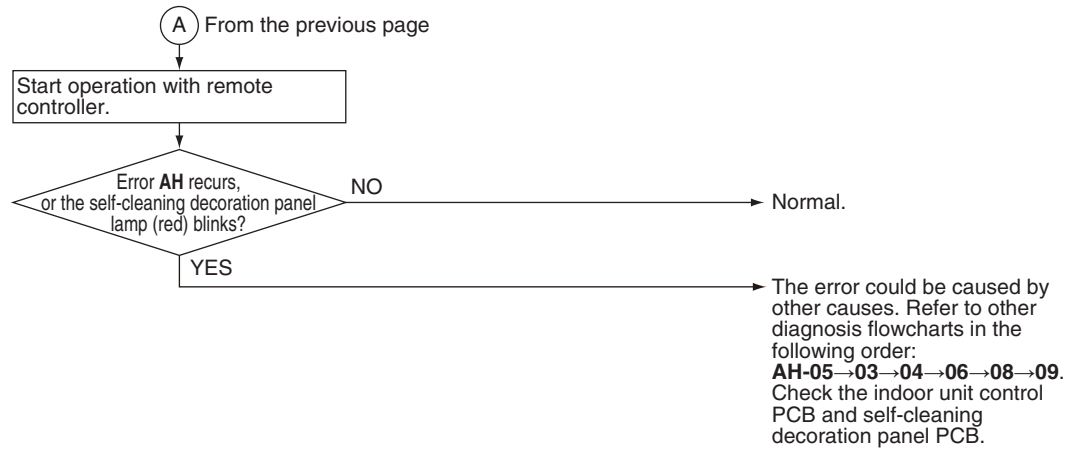

Note(s)

- *1. Temporary error code reset operation can be performed by pressing the push switch button **(BS2)** on the self-cleaning decoration panel PCB

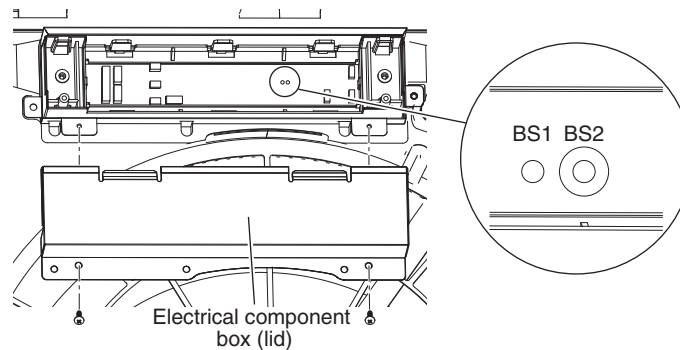

- *2. For details on performing filter auto clean test operation, refer to the operation manual of the self-cleaning decoration panel.

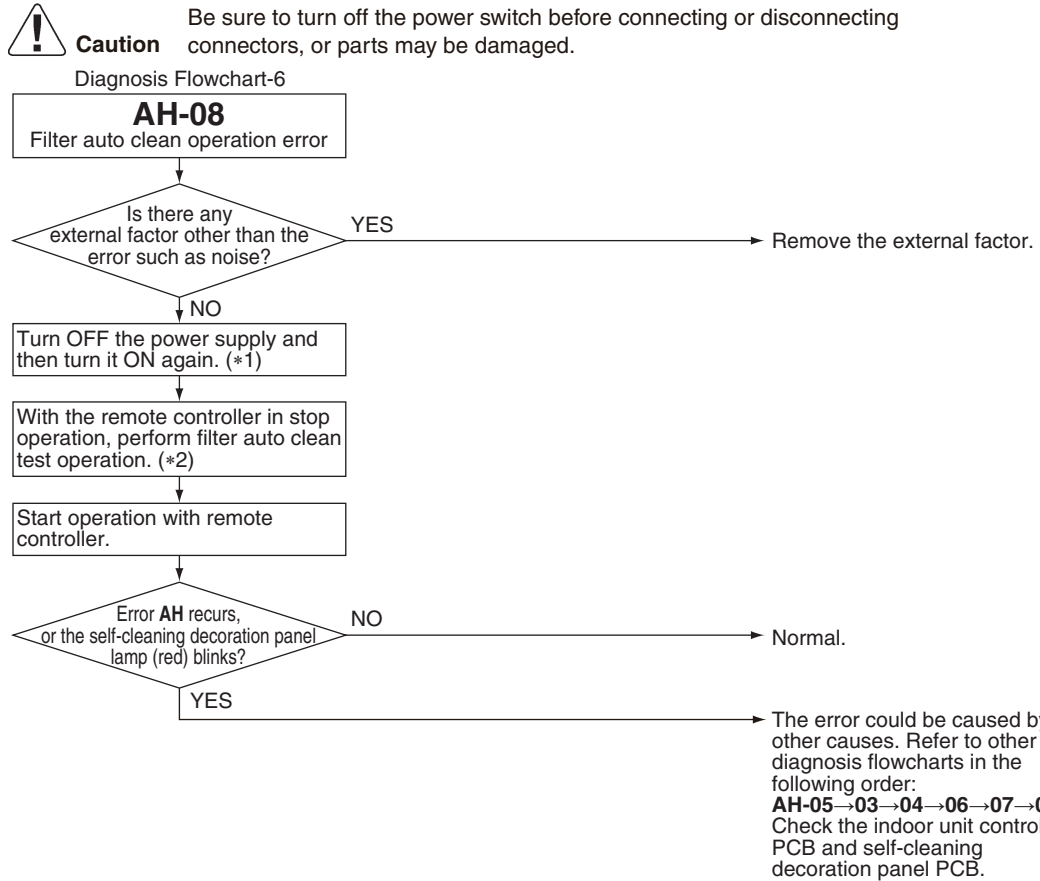

i Note(s)

*1. Temporary error code reset operation can be performed by pressing the push switch button (BS2) on the self-cleaning decoration panel PCB

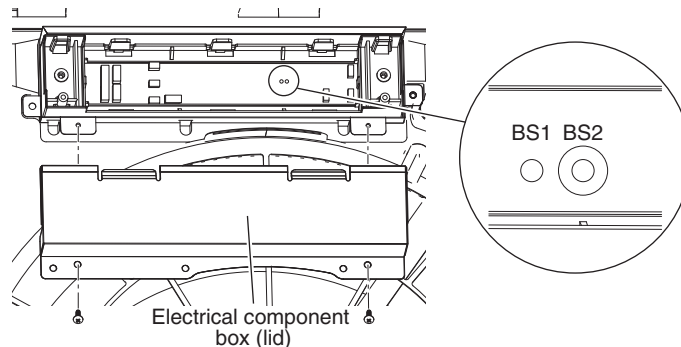

*2. For details on performing filter auto clean test operation, refer to the operation manual of the self-cleaning decoration panel.

**Caution**

Be sure to turn off the power switch before connecting or disconnecting connectors, or parts may be damaged.

Diagnosis Flowchart-7

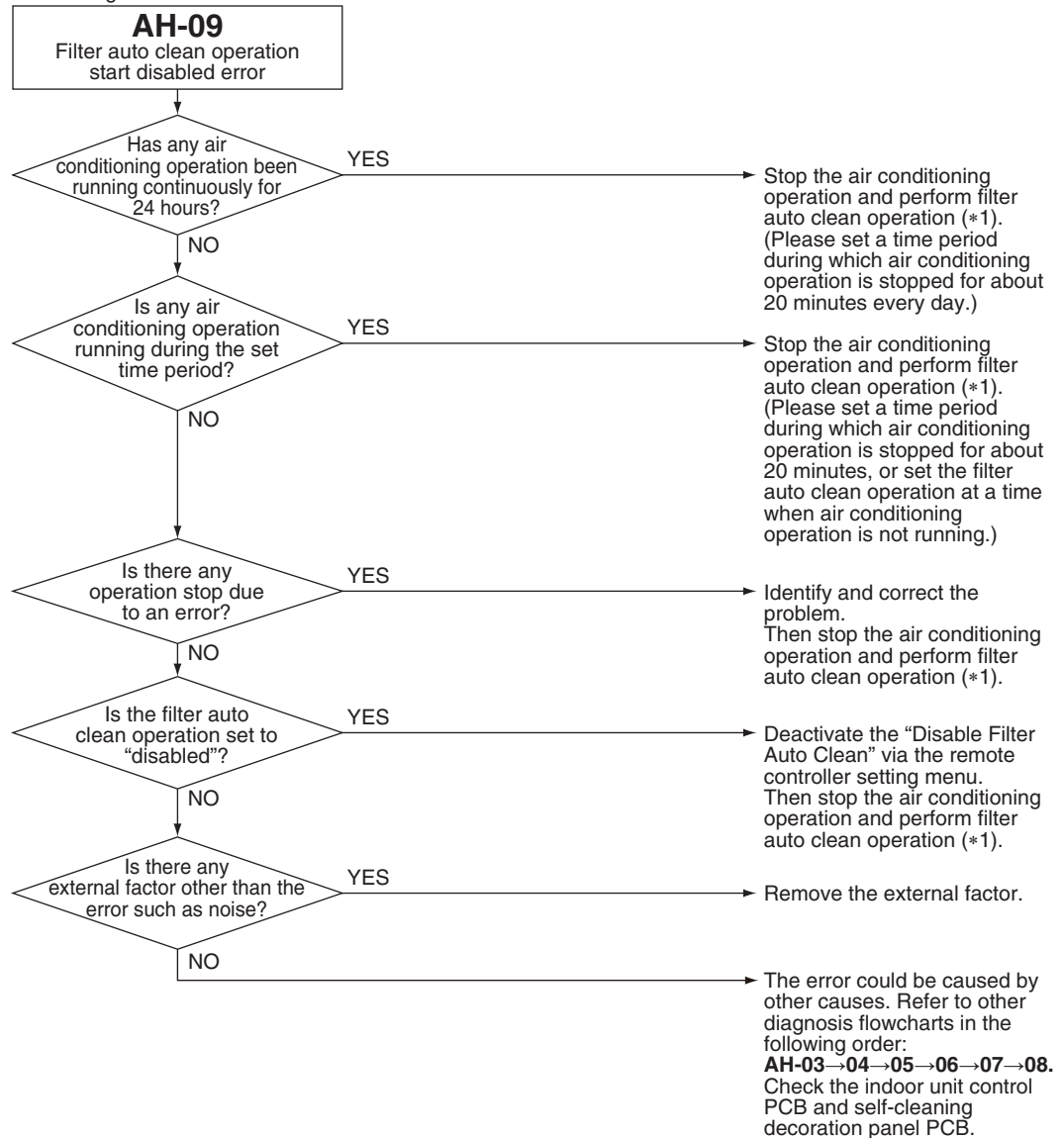
**Note(s)**

*1. If the filter auto clean operation mode is set to a designated time period, perform a filter auto clean operation as described below to clear the **AH** error code. (If scheduled operation time is not set, the filter auto clean operation will be performed automatically after air conditioning operation is stopped, so the following operation is unnecessary.)

1. On the remote controller, select "Filter Auto Clean" menu. The screen will change into a cleaning time period setting screen. Confirm the set time period. (Example: 0:00 to 3:00)
2. Select "Clock & Calendar" on the remote controller and set the current time to the time one minute before the beginning of the time set in step 1. (Example: If the set time is from 0:00 to 3:00, set the current time to 23:59, one minute before 0:00)
3. After about 1 minute, filter auto clean operation will start. (**AH** error cleared)
4. After confirming that the filter auto clean operation is finished, return the time changed in step 2 to the regular time.

5.18 Defective Capacity Setting

Error Code	AJ
Applicable Models	All indoor models
Method of Error Detection	Capacity is determined according to resistance of the capacity setting adaptor and the memory inside the IC memory on the indoor unit PCB, and whether the value is normal or abnormal is determined.
Error Decision Conditions	The capacity code is not saved to the PCB, and the capacity setting adaptor is not connected. A capacity that does not exist for that unit is set.
Supposed Causes	<ul style="list-style-type: none"> ■ Defective capacity setting adaptor connection ■ Defective indoor unit PCB
Troubleshooting	



Caution

Be sure to turn off the power switch before connecting or disconnecting connectors, or parts may be damaged.

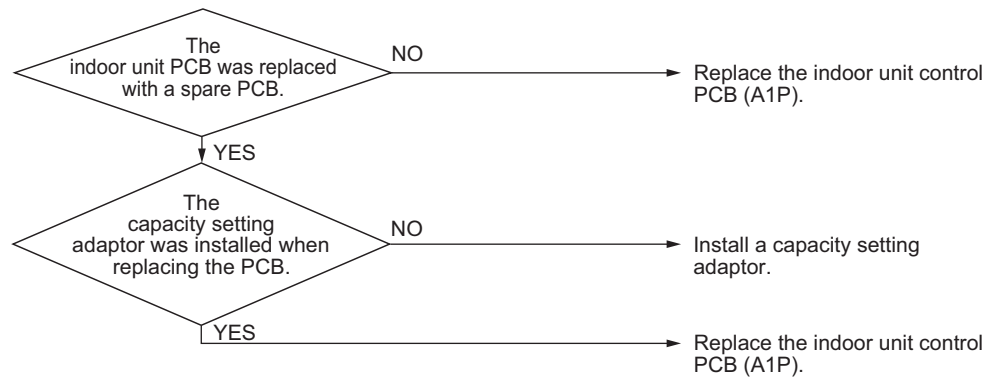

5.19 Transmission Abnormality (between Indoor Unit PCB and Fan PCB)

Error Code	C1
Applicable Models	FBQ-P, FBQ-TB
Method of Error Detection	Transmission conditions between the indoor unit main PCB (A1P) and fan PCB (A2P) are checked via microcomputer.
Error Decision Conditions	Normal transmission is not carried out for a certain duration.
Supposed Causes	<ul style="list-style-type: none"> ■ Defective connection of the connector between indoor unit main PCB (A1P) and fan PCB (A2P) ■ Defective indoor unit main PCB (A1P) ■ Defective fan PCB (A2P) ■ External factor, such as instantaneous power failure

Troubleshooting

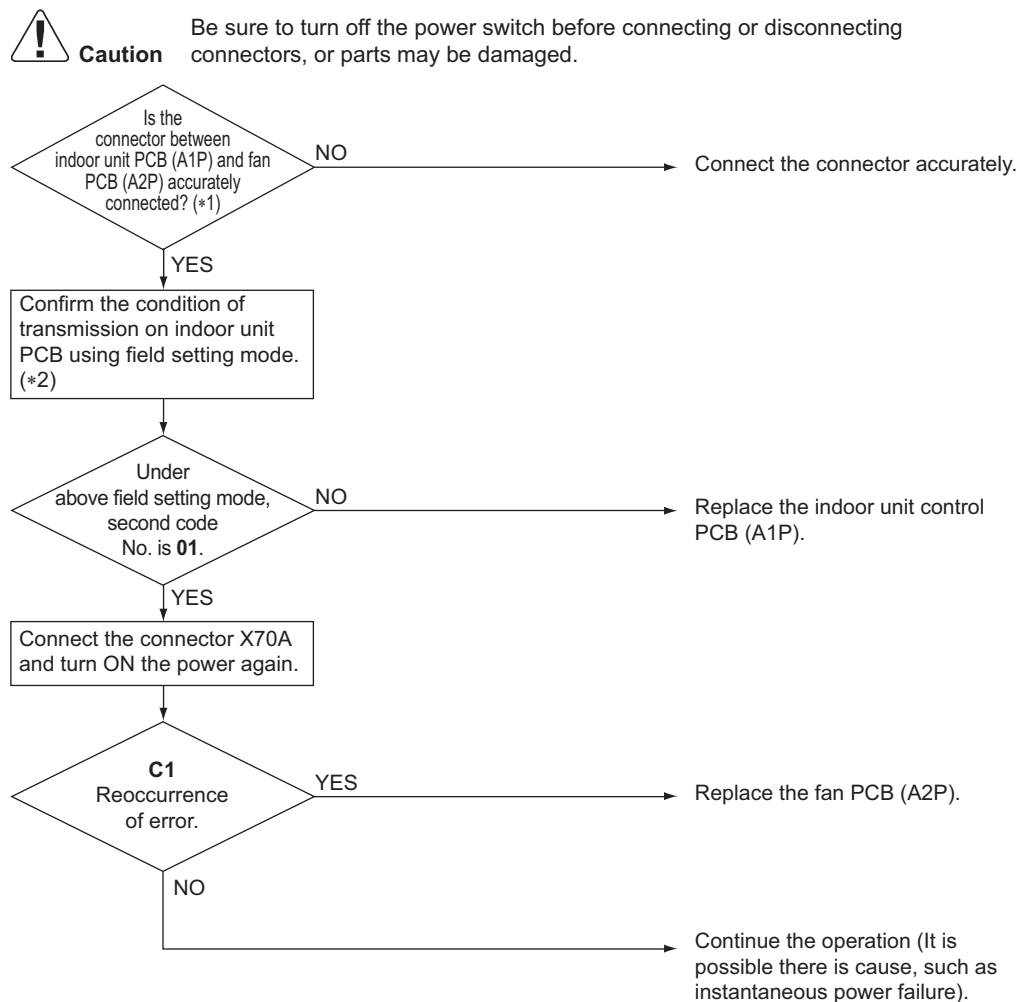

Note(s)

*1. Pull out and insert the connector once and check if it is absolutely connected.

*2. Method to check transmission part of indoor unit control PCB.

(1) Turn OFF the power and remove the connector X70A of indoor unit control PCB (A1P).

(2) Short circuit X70A.

(3) After turning ON the power, check below numbers under field setting from remote controller.

(Confirmation: Second code No. at the condition of first code No. 21 on mode No. 41)

Determination 01: Normal

Other than 01: Transmission error on indoor unit control PCB

* After confirmation, turn OFF the power, take off the short circuit and connect X70A back to original condition.

5.20 Blower Motor Communication Error

Error Code	C1-07
Applicable Models	FTQ-TA
Outline	Error is issued if transmission abnormalities occur between indoor unit and fan motor.
Error Decision Conditions	If the response message from the fan motor is an abnormal message, and determined as such by the indoor unit, the indoor unit will execute a retry. If everything fails for 5 seconds, it is deemed to be a transmission abnormality.
Error Reset Conditions	If the indoor unit receives even a single normal response message from the fan motor, the error will be cleared.
Supposed Causes	<ul style="list-style-type: none">■ Incorrect or loose wiring■ Power interruption (low voltage)
Corrective Actions	<ul style="list-style-type: none">■ Check wiring or tighten wiring connections if needed.■ Verify the input voltage at the motor.■ Replace the indoor unit PCB or motor.

5.21 Thermistor Abnormality

Error Code	C4, C5, C9, CA
Applicable Models	C4, C5: All indoor units C9: except FTQ-TA models CA: FBQ-P models only
Method of Error Detection	The error is determined by the temperature detected by the thermistor.
Error Decision Conditions	The thermistor becomes disconnected or shorted while the unit is running.
Supposed Causes	<ul style="list-style-type: none"> ■ Defective thermistor ■ Defective indoor unit PCB ■ Defective connector connection ■ Broken or disconnected wire

Troubleshooting



Caution

Be sure to turn off the power switch before connecting or disconnecting connectors, or parts may be damaged.

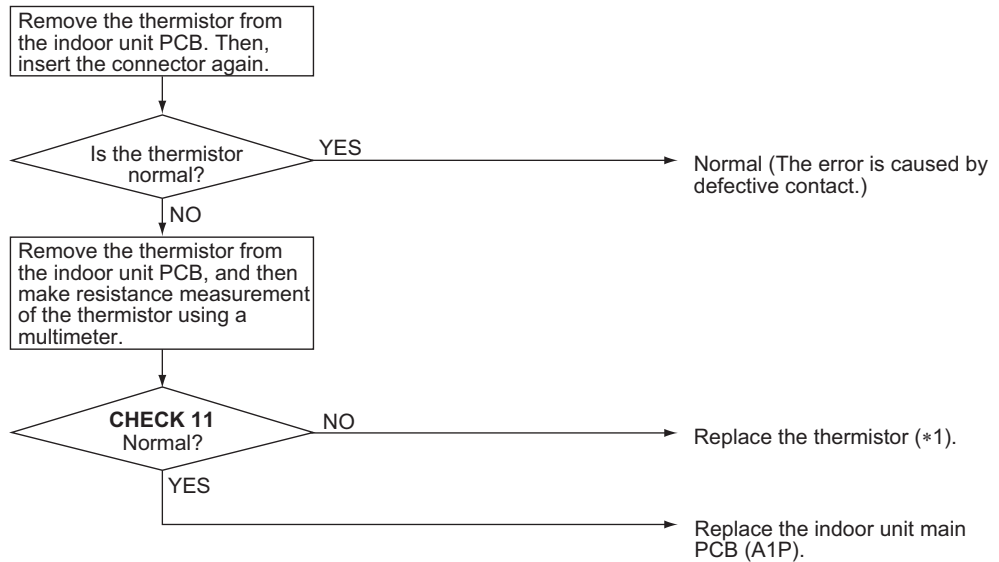

Note(s)

*1. Error code and thermistor

Error Code	Thermistor	Except FBQ-P FTQ-TA	FBQ-P	FTQ-TA
C4	Heat exchanger liquid pipe thermistor	R2T	R2T	R2T
C5	Heat exchanger gas pipe thermistor	R3T	R3T	R3T
C9	Suction air thermistor	R1T	R1T	*2
CA	Discharge air thermistor	—	R4T	—

*2. Refer to page 290 for **C9** for FTQ-TA models.



Reference

CHECK 11 Refer to page 348.

5.22 Combination Abnormality (between Indoor Unit PCB and Fan PCB)

Error Code	C6
Applicable Models	FBQ-P, FBQ-TB
Method of Error Detection	Transmission conditions with fan PCB (A2P) are checked using the indoor unit PCB (A1P).
Error Decision Conditions	Communication data of fan PCB (A2P) is determined as incorrect.
Supposed Causes	<ul style="list-style-type: none"> ■ Defective fan PCB (A2P). ■ Defective connection of capacity setting adaptor ■ Defective setting error

Troubleshooting

Caution

Be sure to turn off the power switch before connecting or disconnecting connectors, or parts may be damaged.

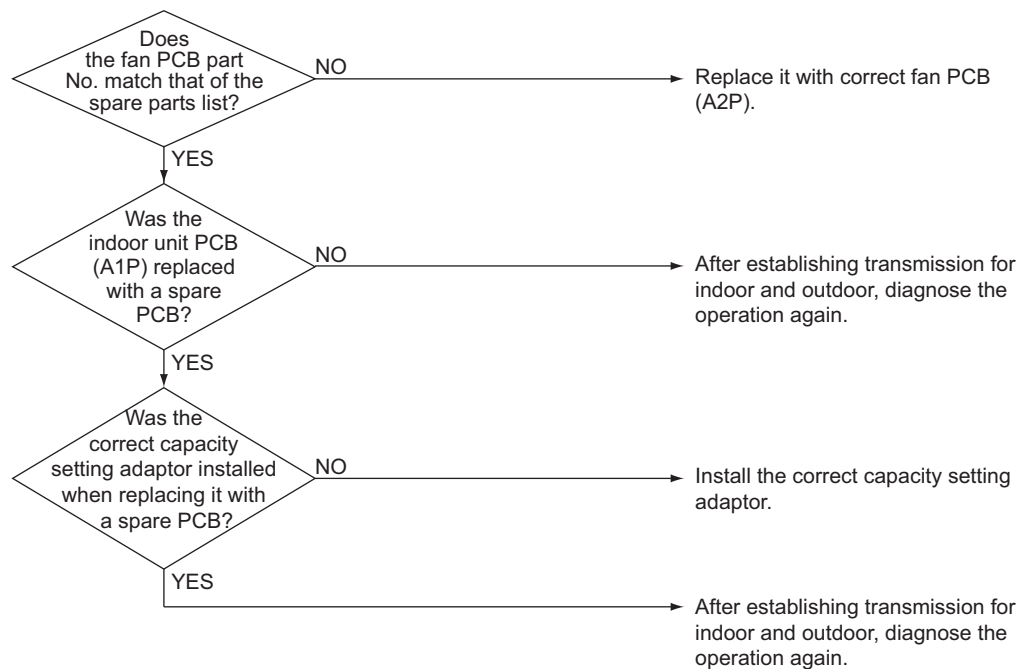

5.23 Blower Motor HP Mismatch

Error Code	C6-01
Applicable Models	FTQ-TA
Outline	Error is issued if the manufacturer ID and output of the connected fan motor do not match those recognized by the indoor unit.
Error Decision Conditions	Gathers information on the manufacturer ID and output of the fan motor when initializing the fan motor. If those figures are not the values recognized by the indoor unit, it will be deemed abnormal operation. If deemed abnormal operation, it will keep retrying until the figures match.
Error Reset Conditions	If the manufacturer ID and output match, the error will be cleared.
Supposed Causes	<ul style="list-style-type: none"> ■ Incorrect size motor ■ Indoor unit capacity setting error
Corrective Actions	<ul style="list-style-type: none"> ■ Correct motor installation. ■ Correct the indoor unit capacity setting.

5.24 Indoor Blower Does Not Have Required Parameters to Function

Error Code	C6-02
Applicable Models	FTQ-TA
Outline	Indoor units perform required settings for control on the fan motor, but if the minimum required settings are not made then information indicating as such will be included among the periodic control status information. Error is issued when the information shows abnormality.
Error Decision Conditions	If the parameter information shows abnormality, it will be deemed abnormal operation. At that point, parameter settings when initializing the fan motor will be implemented from the beginning.
Error Reset Conditions	If the parameter information is normal, the error will be cleared.
Supposed Causes	<ul style="list-style-type: none"> ■ Locked motor rotor condition
Corrective Actions	<ul style="list-style-type: none"> ■ Check for locked rotor condition. ■ Replace the indoor unit PCB or motor.

5.25 Remote Sensor Abnormality

Error Code	C9
Applicable Models	FTQ-TA
Method of Error Detection	The error is detected by remote sensor temperature.
Error Decision Conditions	When the remote sensor becomes disconnected or shorted while the unit is running.
Supposed Causes	<ul style="list-style-type: none"> ■ Defective indoor unit thermistor (R1T) for room temperature ■ Defective indoor unit PCB

Troubleshooting



Caution

Be sure to turn off the power switch before connecting or disconnecting connectors, or parts may be damaged.

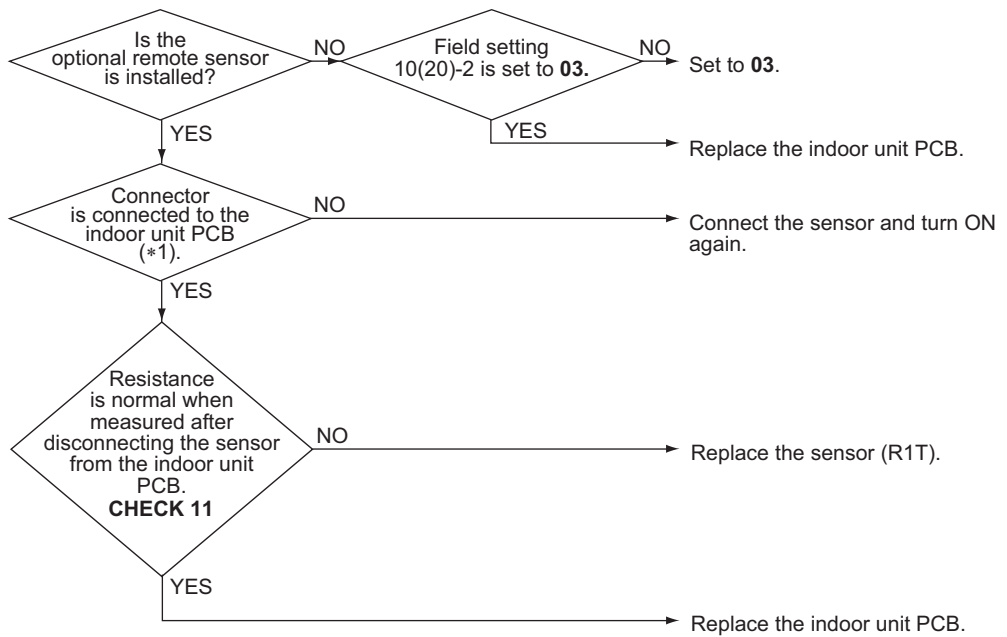

Note(s)

*1. Connector and indoor unit PCB

Model	Connector for remote sensor	PCB
FTQ-TA	X4A	A1P



Reference

CHECK 11 Refer to page 348.

5.26 Infrared Presence/Floor Sensor Error

Error Code	CE
Applicable Models	FCQ-TA, FCQ-AA
Method of Error Detection	The contents of a failure vary with the detailed error code. Check the code and proceed with the flowchart.
Error Decision Conditions	Error is detected based on sensor output signals
Supposed Causes	<ul style="list-style-type: none"> ■ Defective or disconnected infrared presence sensor connector: CE-01 ■ Defective infrared floor sensor (Temperature compensation circuit disconnection): CE-02 ■ Defective infrared floor sensor (Temperature compensation short circuit): CE-03 ■ Defective infrared floor sensor element: CE-04

Troubleshooting



Caution

Be sure to turn off the power switch before connecting or disconnecting connectors, or parts may be damaged.

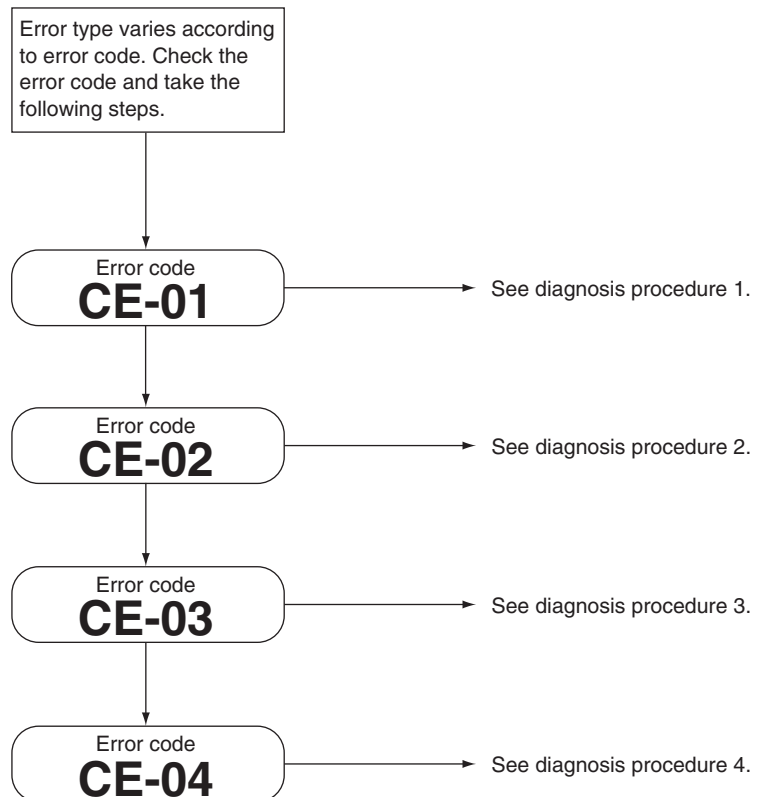

Troubleshooting

Diagnosis procedure 1

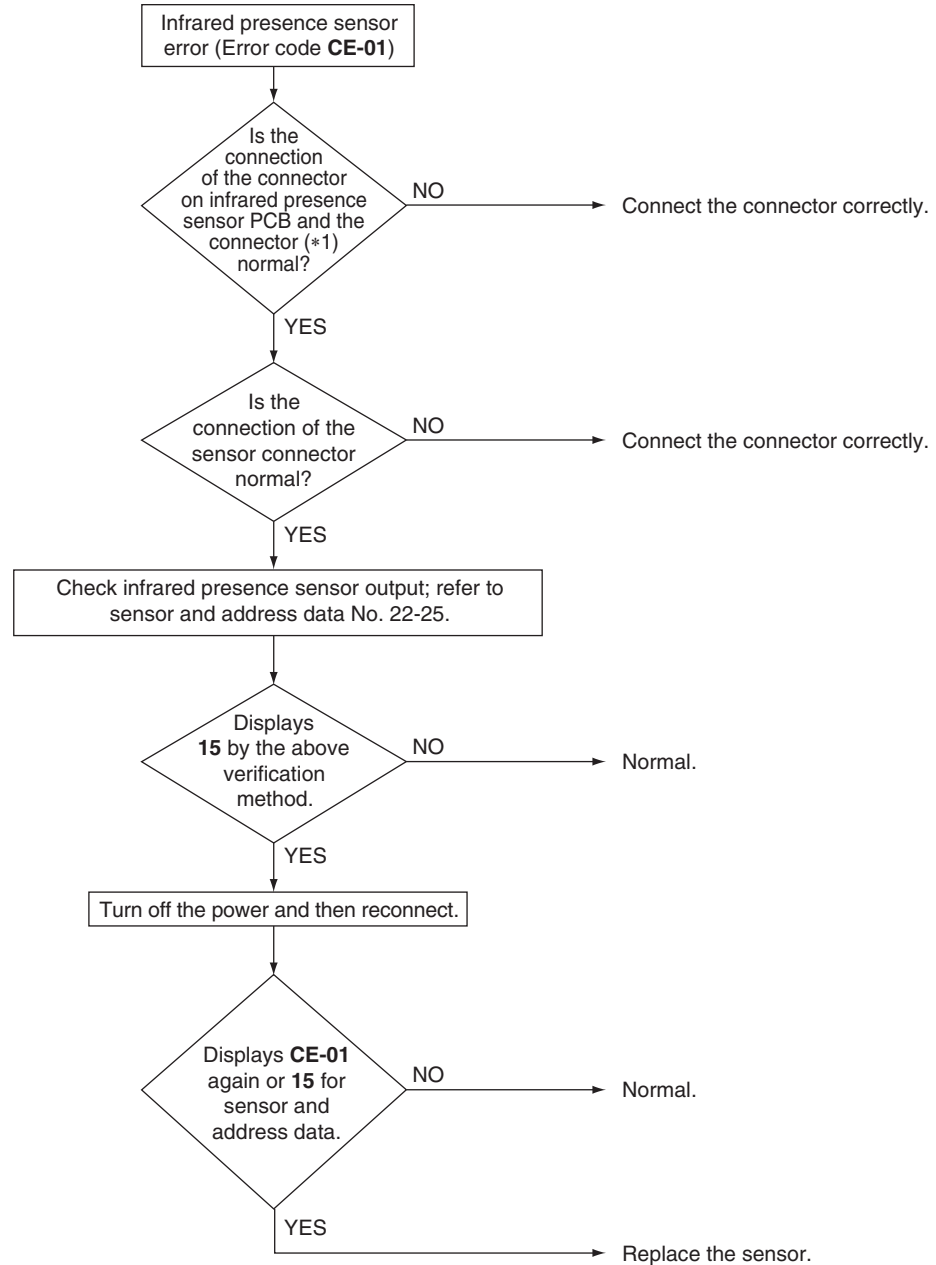

Note(s)

*1. Infrared presence sensor PCB and connector

Model	Infrared presence sensor PCB	Connector
FCQ-TA	A4P	X2A (A2P)
FCQ-AA	A3P	X81A (A1P)

Troubleshooting

Diagnosis procedure 2

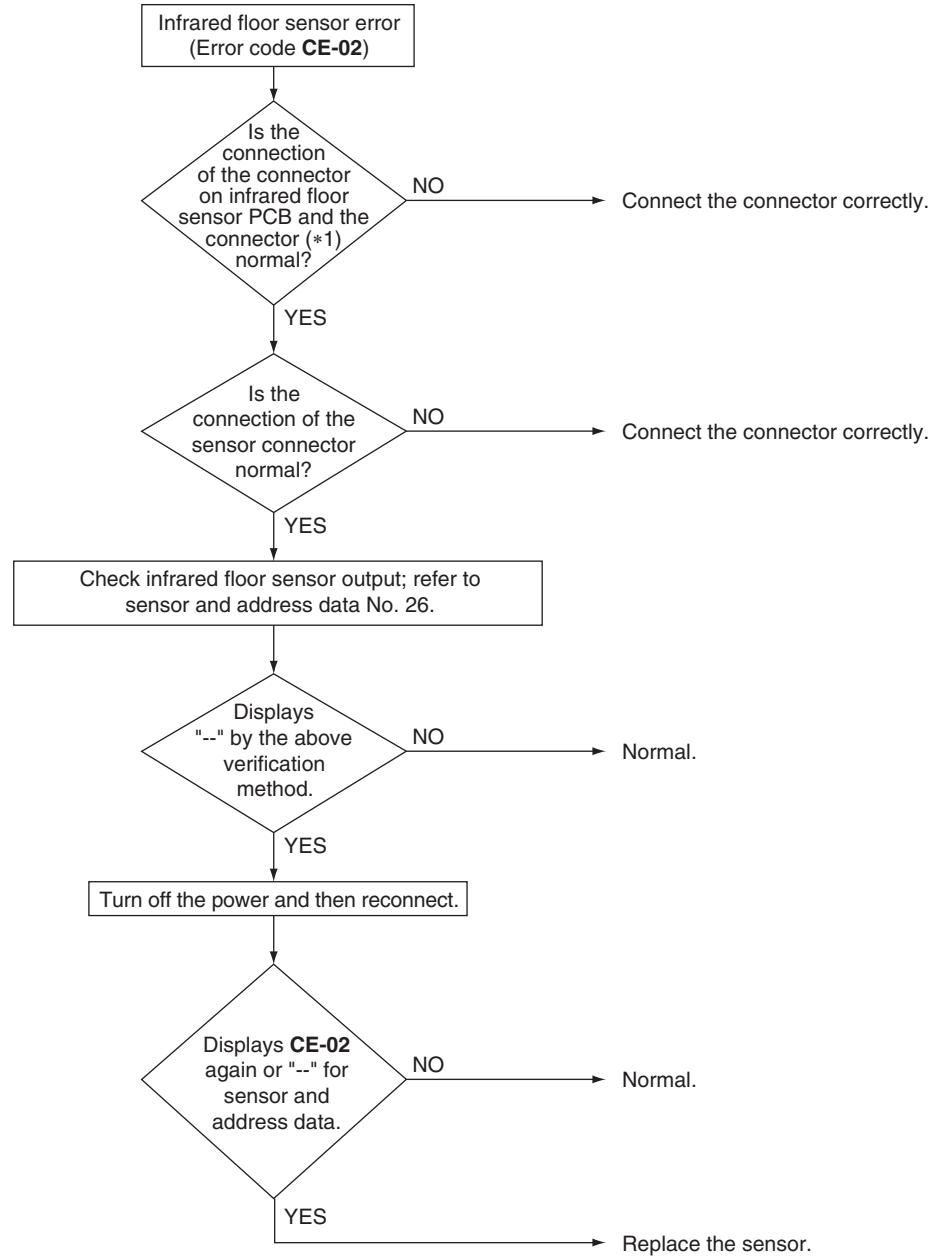

Note(s)

*1. Infrared floor sensor PCB and connector

Model	Infrared floor sensor PCB	Connector
FCQ-TA	A3P	X2A (A2P)
FCQ-AA	A2P	X81A (A1P)

Troubleshooting

Diagnosis procedure 3

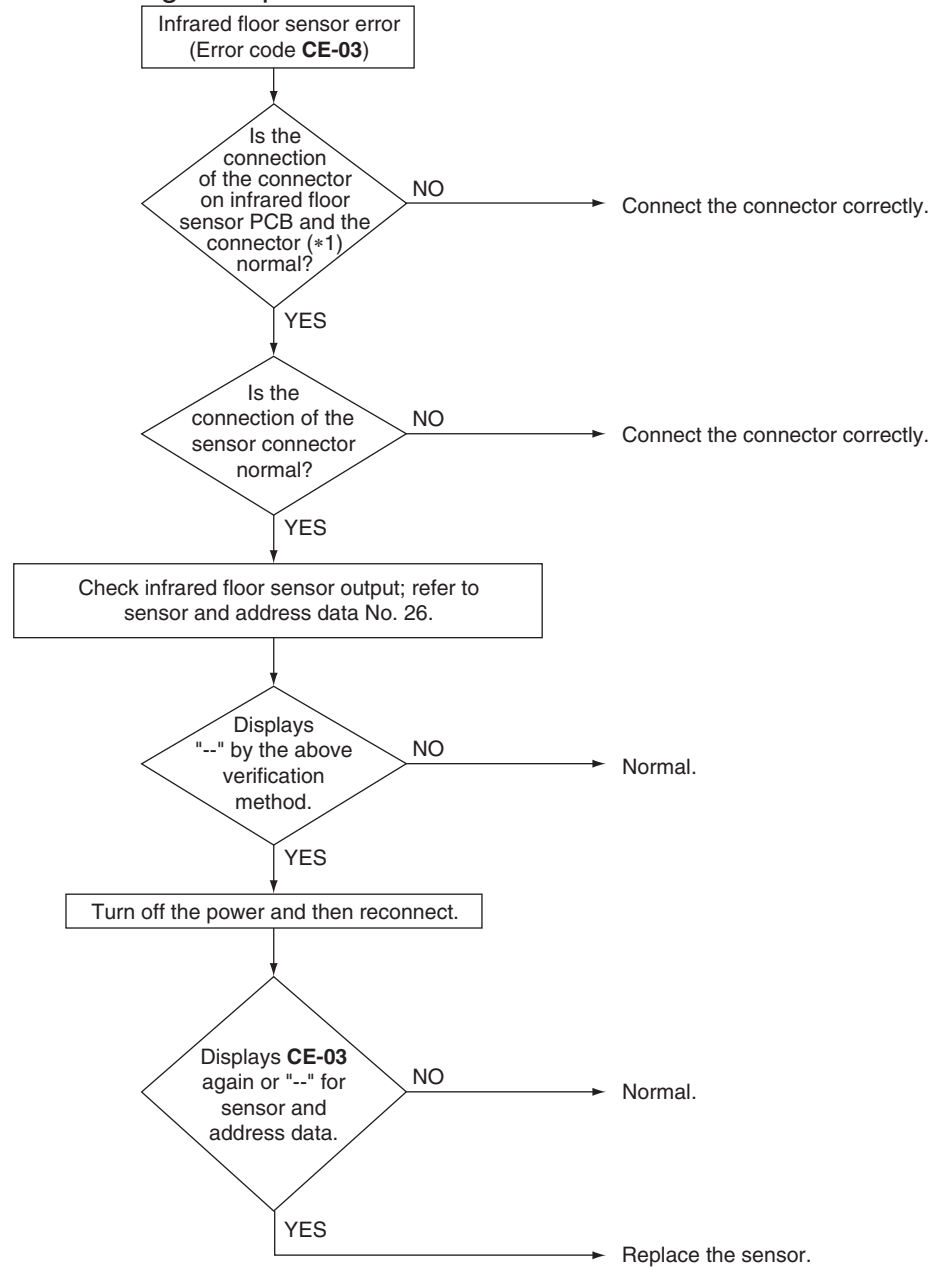

Note(s)

*1. Infrared floor sensor PCB and connector

Model	Infrared floor sensor PCB	Connector
FCQ-TA	A3P	X2A (A2P)
FCQ-AA	A2P	X81A (A1P)

Troubleshooting

Diagnosis procedure 4

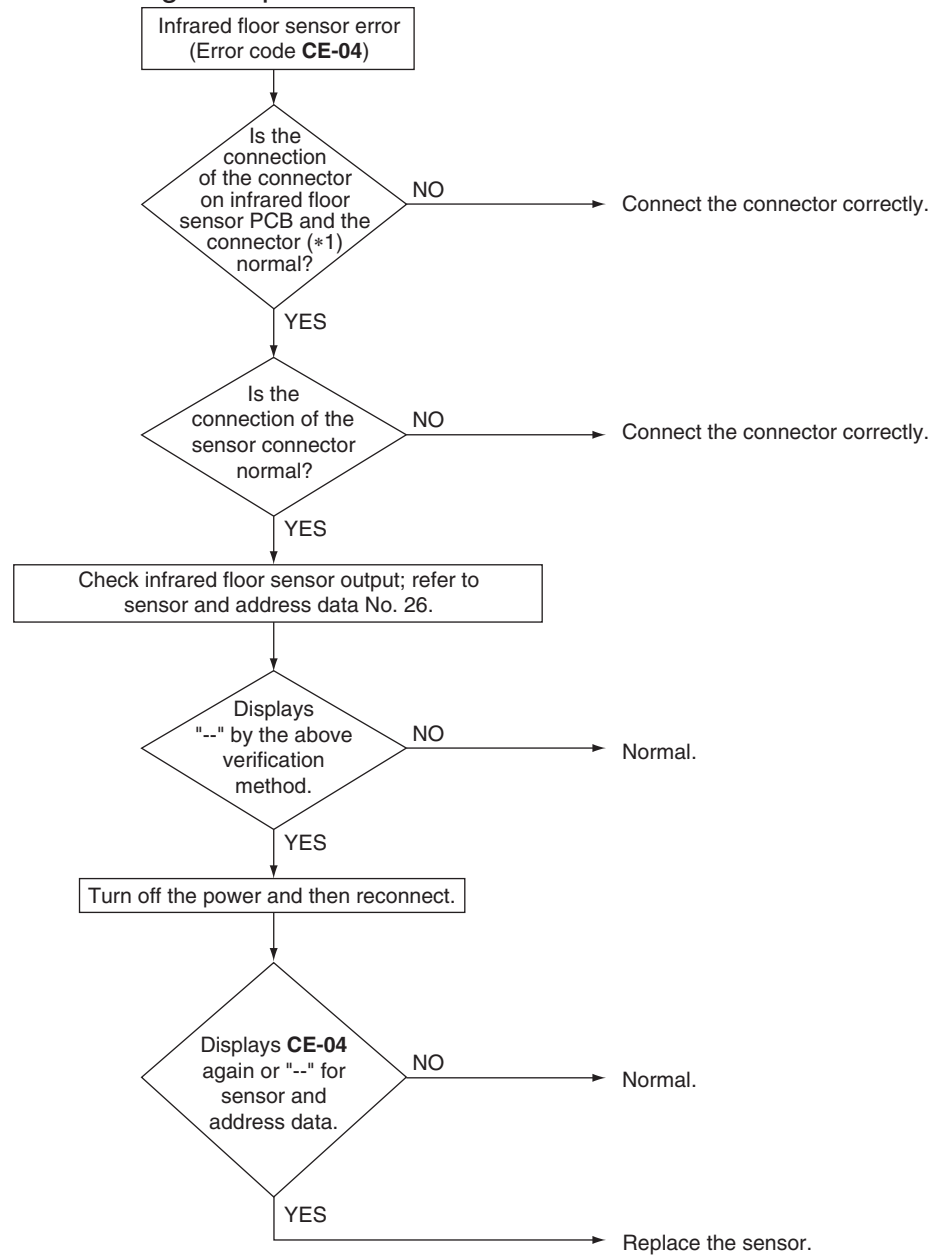

Note(s)

*1. Infrared floor sensor PCB and connector

Model	Infrared floor sensor PCB	Connector
FCQ-TA	A3P	X2A (A2P)
FCQ-AA	A2P	X81A (A1P)

5.27 Remote Controller Thermistor Abnormality

Error Code	CJ
Applicable Models	All indoor models
Method of Error Detection	Error detection is carried out by the temperature detected by remote controller thermistor.
Error Decision Conditions	When the remote controller thermistor becomes disconnected or shorted while the unit is running. * Error code is displayed but the system operates continuously.
Supposed Causes	<ul style="list-style-type: none"> ■ Defective remote controller thermistor ■ Defective remote controller PCB ■ External factor (Noise, etc.)

Troubleshooting

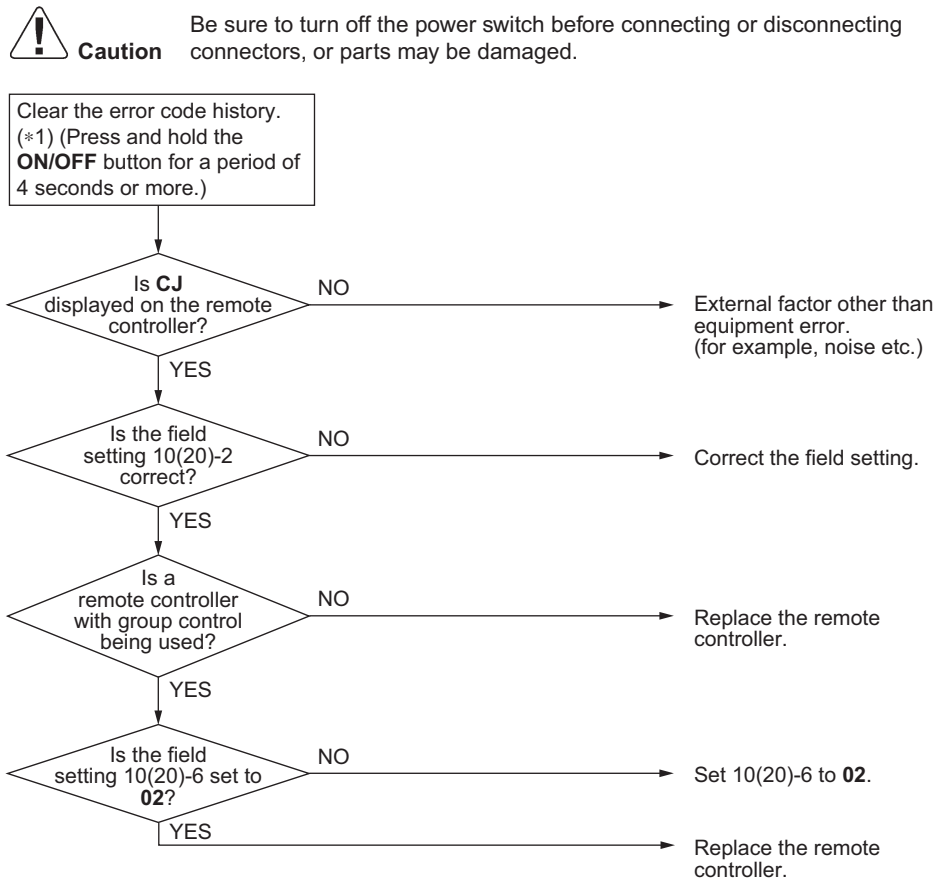

 **Note(s)**

- *1. How to delete the history of error codes.
Press the **ON/OFF** button for 4 seconds and more while the error code is displayed.

5.28 Outdoor Main PCB Abnormality

Error Code	E1
Applicable Models	All outdoor units
Method of Error Detection	Abnormality is detected under the communication conditions in the hardware section between the indoor unit and outdoor unit.
Error Decision Conditions	When the communication conditions in the hardware section between the indoor unit and the outdoor unit are not normal.
Supposed Causes	<ul style="list-style-type: none"> ■ Defective outdoor unit main PCB (A1P) ■ Disconnection of the inside/outside relay wires
Troubleshooting	

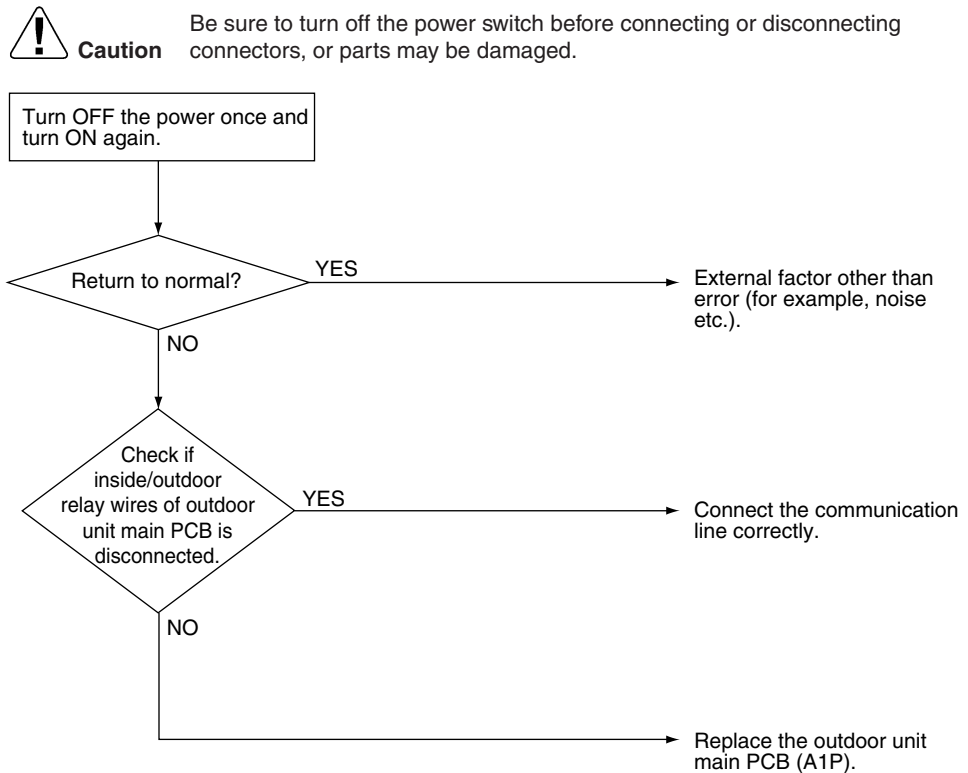

5.29 Activation of High Pressure Switch

Error Code	E3
Applicable Models	All outdoor units
Method of Error Detection	Abnormality is detected when the contact of the high pressure switch opens. Use the protection device circuit to test high pressure switch conduction.
Error Decision Conditions	Part of the protection device has an open circuit. Error is generated when the high pressure switch activation count reaches the number specific to the operation mode. Reference Operating pressure: 4.0 MPa (580 psi) Reset pressure: 3.0 MPa (435 psi)
Supposed Causes	<ul style="list-style-type: none"> ■ Activation of outdoor unit high pressure switch ■ Defective high pressure switch ■ Defective outdoor unit main PCB ■ Instantaneous power failure ■ Defective high pressure sensor

Troubleshooting

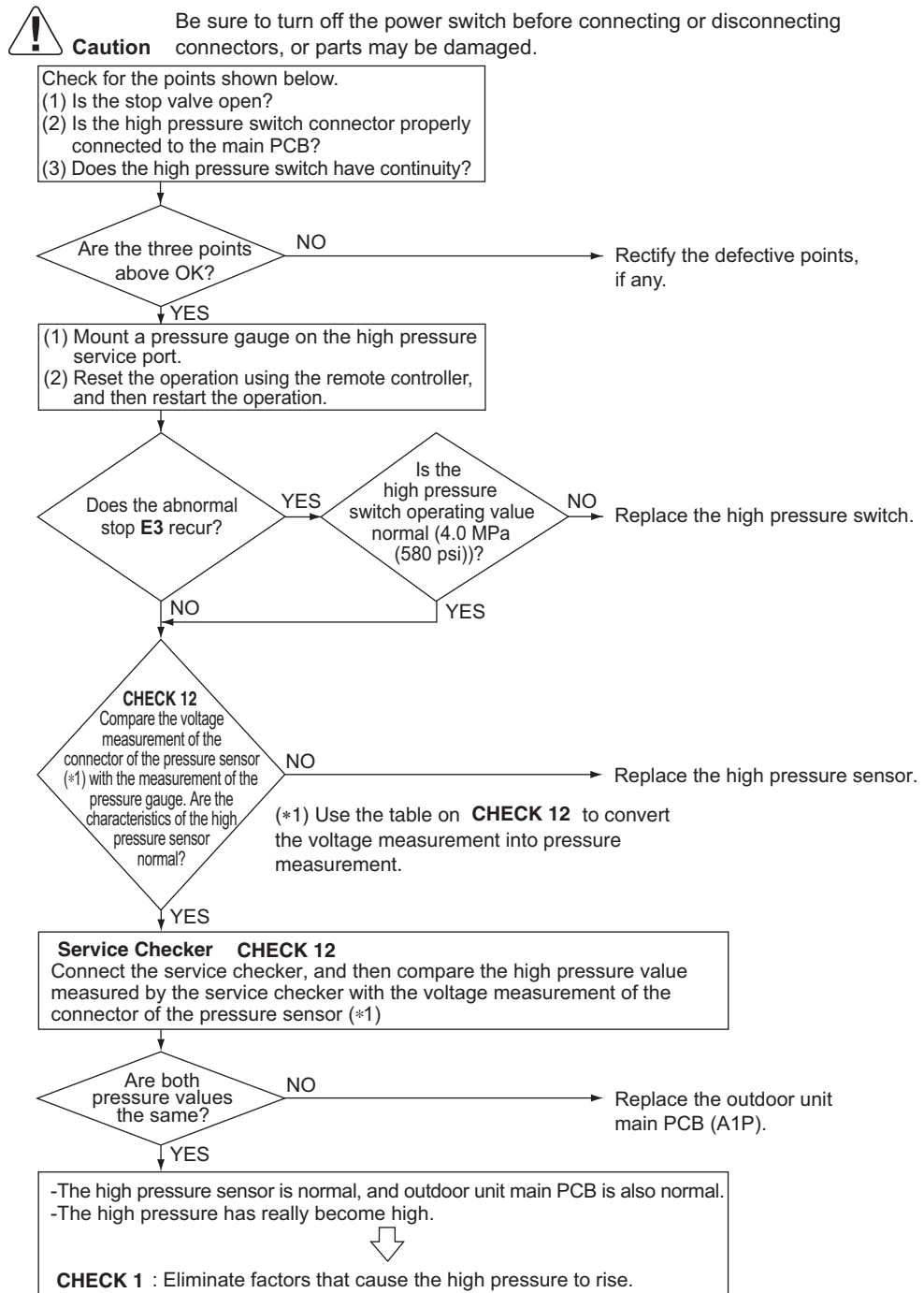

Reference

CHECK 1 Refer to page 337.

Reference

CHECK 12 Refer to page 351.

5.30 Activation of Low Pressure Sensor

Error Code	E4
Applicable Models	All outdoor units
Method of Error Detection	Abnormality is detected by the pressure value with the low pressure sensor. Use the outdoor main PCB to determine the low pressure sensor pressure test value.
Error Decision Conditions	Error is generated when the low pressure drops below a specific pressure level. Low pressure drops after compressor activation. Operating pressure: 0.07 MPa (10.2 psi)
Supposed Causes	<ul style="list-style-type: none"> ■ Abnormal drop of low pressure ■ Defective low pressure sensor ■ Defective outdoor unit main PCB ■ Stop valve is not opened

Troubleshooting

**Caution**

Be sure to turn off the power switch before connecting or disconnecting connectors, or parts may be damaged.

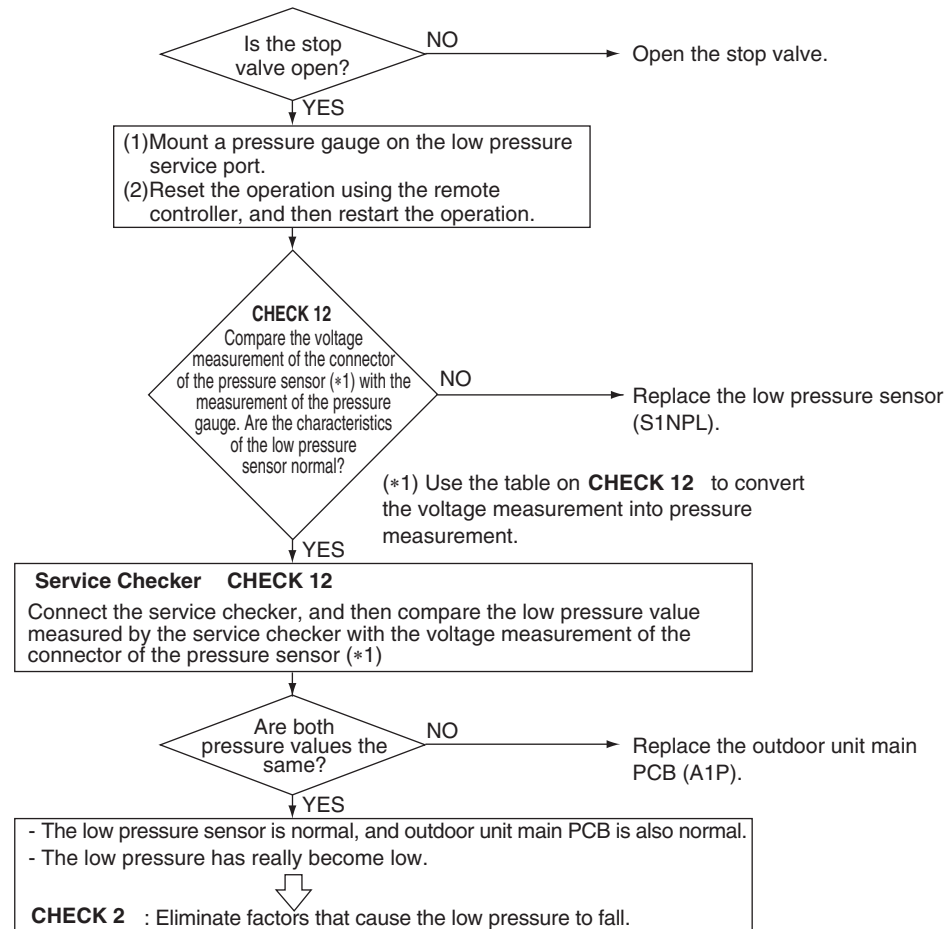

Reference **CHECK 2** Refer to page 338.



Reference **CHECK 12** Refer to page 351.

5.31 Compressor Motor Lock

Error Code	E5
Applicable Models	All outdoor units
Method of Error Detection	PCB takes the position signal from UVW line connected between the inverter and compressor, and the error is detected when any abnormality is observed in the phase-current waveform.
Error Decision Conditions	This error will be output when the compressor motor does not start up even in forced startup mode.
Supposed Causes	<ul style="list-style-type: none"> ■ Compressor lock ■ High differential pressure (0.5 MPa (72.5 psi) and above) ■ Incorrect UVW wiring ■ Defective PCB ■ Stop valve is not opened

Troubleshooting



Caution

Be sure to turn off the power switch before connecting or disconnecting connectors, or parts may be damaged.

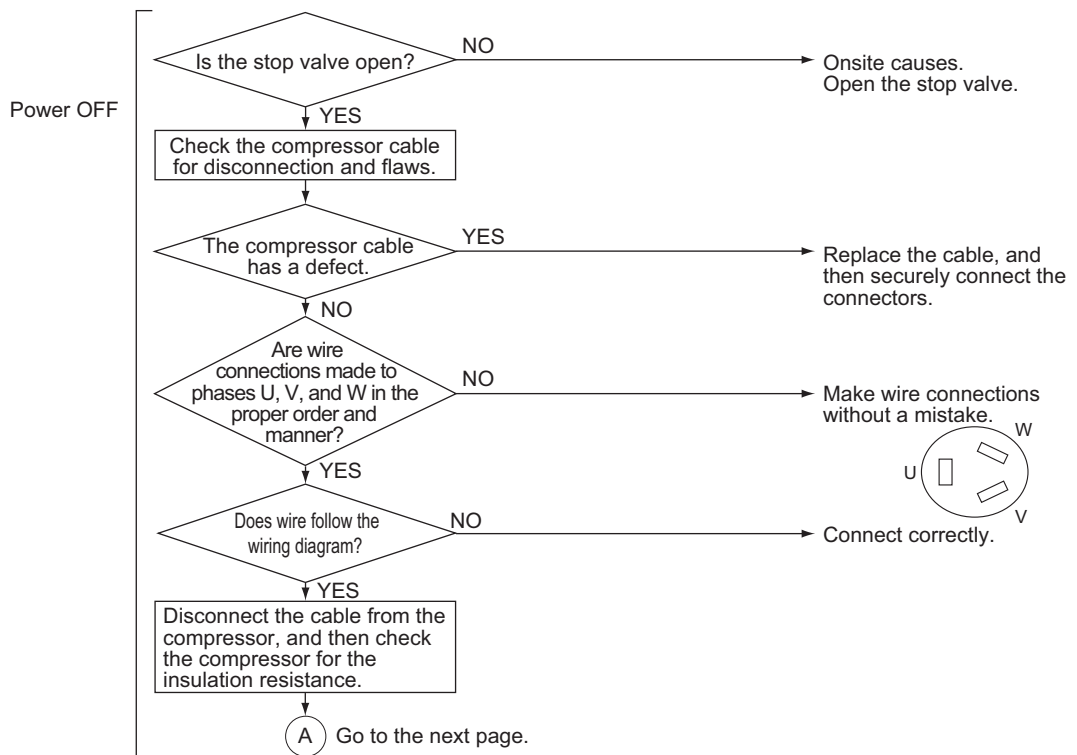

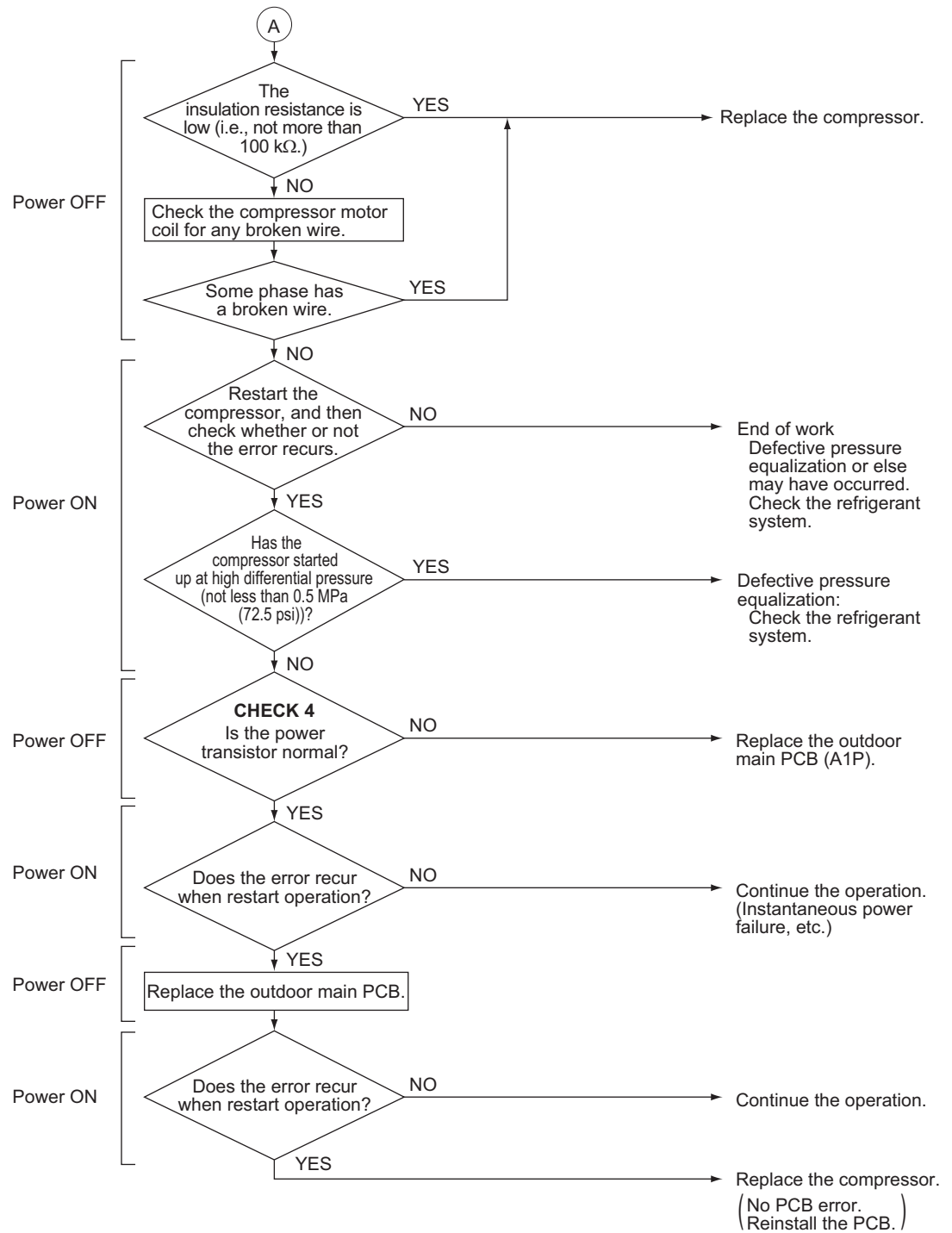

Reference

CHECK 4 Refer to page 342.

5.32 Outdoor Fan Motor Abnormality

Error Code	E7
Applicable Models	All outdoor units
Method of Error Detection	The fan motor circuit error is detected based on the rotation frequency detected by Hall IC during the fan motor operation.
Error Decision Conditions	In the condition of fan motor rotation, the number of rotation is below the fixed number for more than 6 seconds. (System down is caused by 4 times of detection.)
Supposed Causes	<ul style="list-style-type: none">■ Defective fan motor■ Defect or connection error of the connectors/harness between the fan motor and PCB■ The fan cannot rotate due to obstruction of foreign matter.■ Clear condition: Continue normal operation for 5 minutes■ Missing phase L1 and missing phase N

Troubleshooting

**Caution**

Be sure to turn off the power switch before connecting or disconnecting connectors, or parts may be damaged.

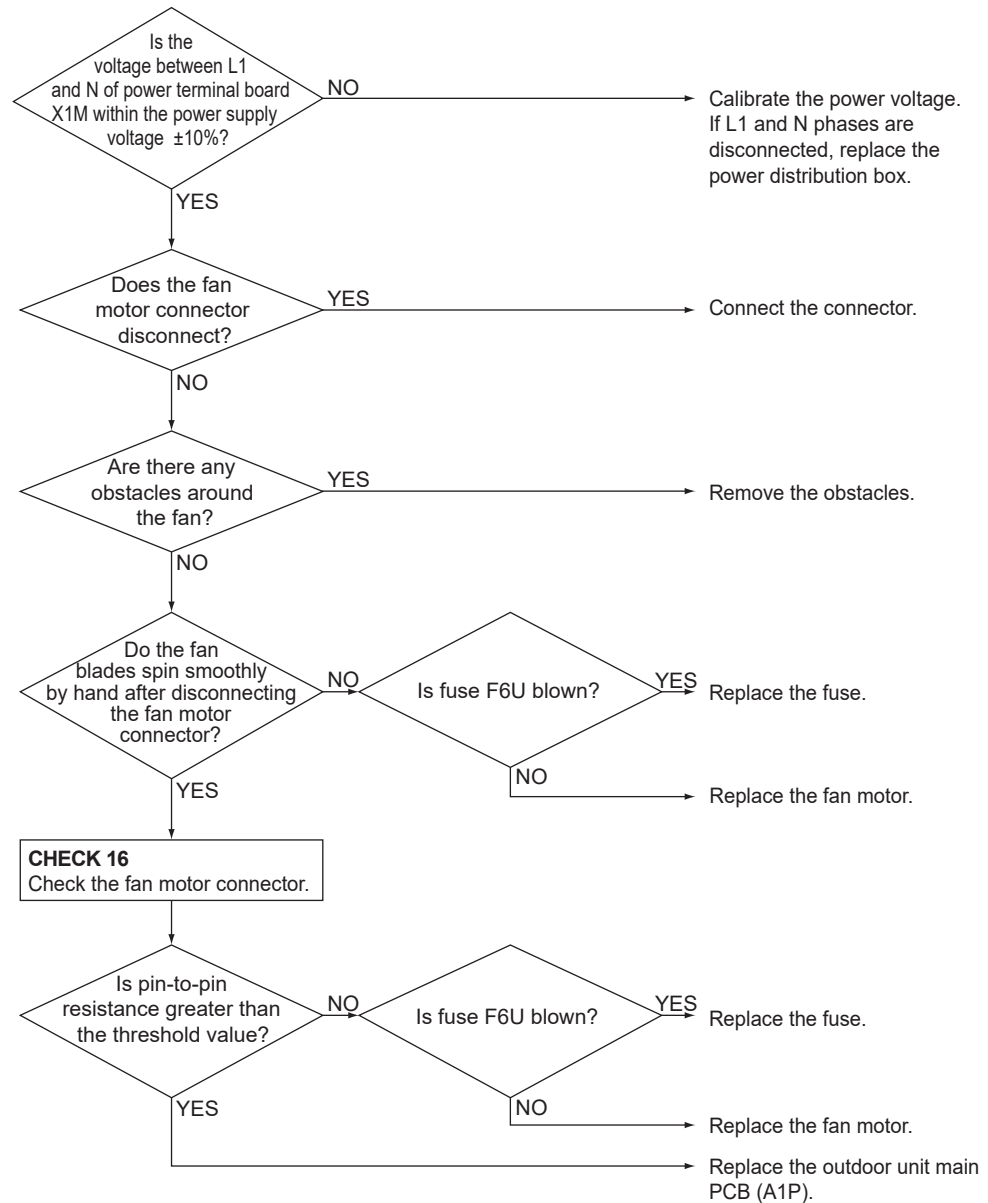

Reference

CHECK 16 Refer to page 353.

5.33 Electronic Expansion Valve Coil Abnormality

Error Code	E9
Applicable Models	All outdoor units
Method of Error Detection	Check continuity of electronic expansion valve coil.
Error Decision Conditions	No current is detected in the common (COM [+]) when power supply is ON.
Supposed Causes	<ul style="list-style-type: none"> ■ Defective electronic expansion valve coil ■ Defective outdoor unit main PCB ■ Disconnection of connectors for electronic expansion valve
Troubleshooting	



Caution

Be sure to turn off the power switch before connecting or disconnecting connectors, or parts may be damaged.

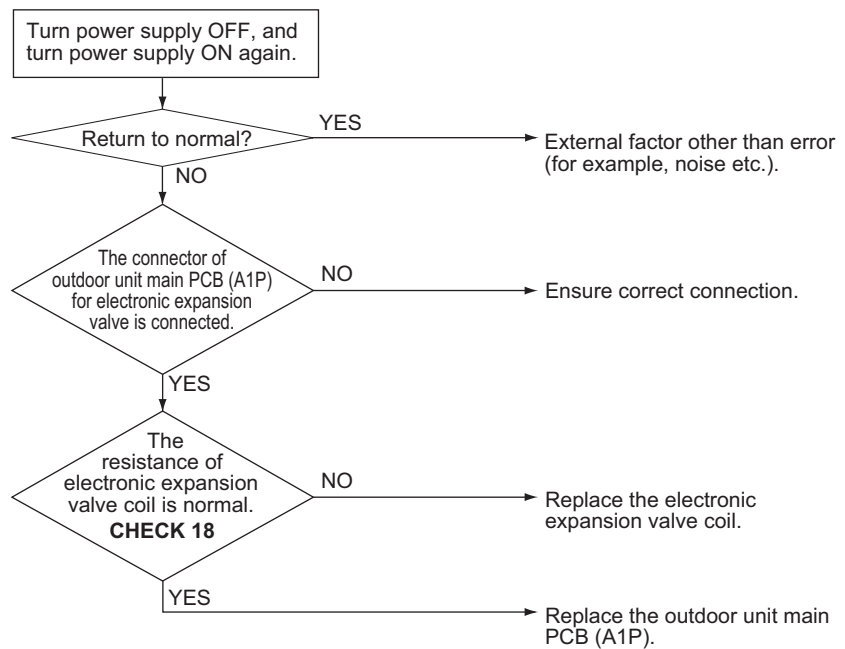

Reference

CHECK 18 Refer to page 355.

5.34 Discharge Pipe Temperature Abnormality

Error Code

F3

Applicable Models

All outdoor units

Method of Error Detection

Abnormality is detected according to the temperature detected by the discharge pipe thermistor.

Error Decision Conditions

The discharge pipe temperature rises to an abnormally high level.
The discharge pipe temperature rises suddenly.

Supposed Causes

- Defective discharge pipe thermistor (R2T)
- Disconnection of discharge pipe thermistor (R2T)
- Defective outdoor unit PCB

Troubleshooting



Caution

Be sure to turn off the power switch before connecting or disconnecting connectors, or parts may be damaged.

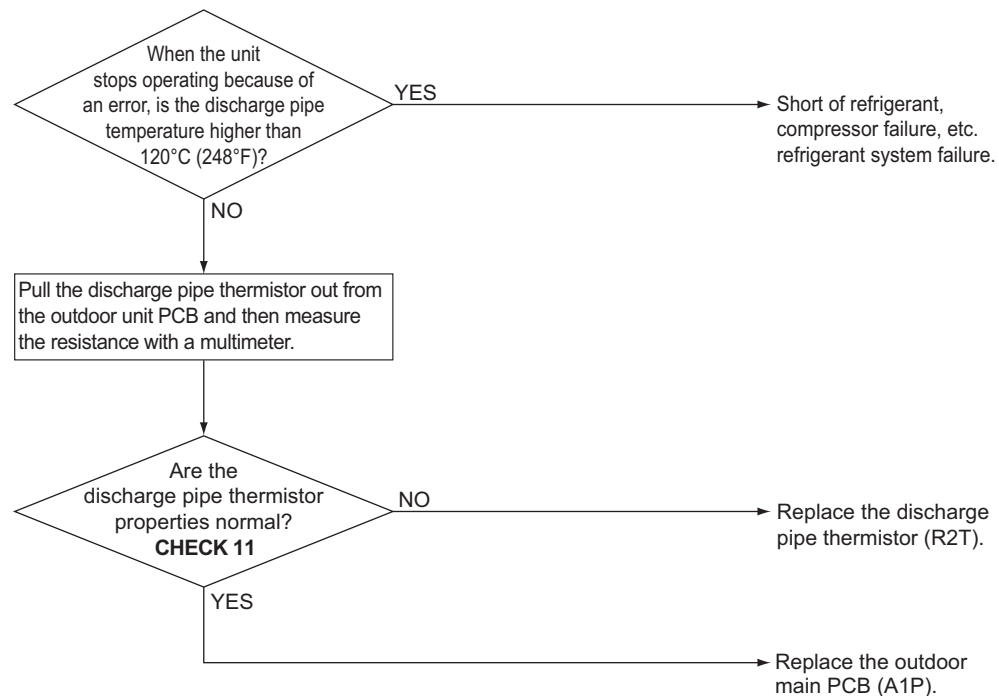

Reference

CHECK 11 Refer to page 348.

5.35 Refrigerant Overcharged

Error Code	F6
Applicable Models	All outdoor units
Method of Error Detection	Excessive charging of refrigerant is detected by using the outdoor air temperature, heat exchanger deicer temperature and liquid pipe temperature during a check operation.
Error Decision Conditions	During a check operation, the amount of refrigerant will be calculated based on the outdoor temperature, the heat exchanger deicer temperature, and the liquid pipe temperature. If the calculated amount exceeds the normal amount by 30%, too much refrigerant has been added. (Adding only slightly more than the normal amount of refrigerant may also cause F6 to be displayed)
Supposed Causes	<ul style="list-style-type: none"> ■ Refrigerant overcharge ■ Disconnection of outdoor air thermistor, heat exchanger deicer thermistor, liquid pipe thermistor ■ Defective outdoor air thermistor, heat exchanger deicer thermistor, liquid pipe thermistor

Troubleshooting

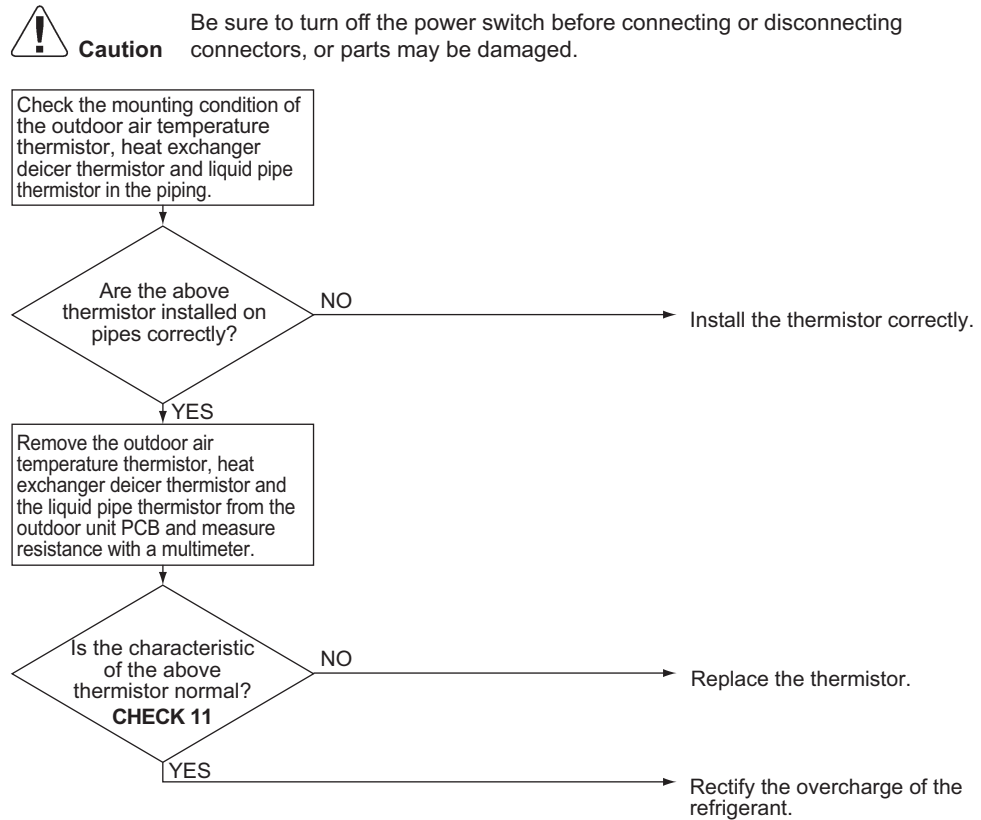

Reference

CHECK 11 Refer to page 348.

5.36 Thermistor Abnormality

Error Code

H9, J3, J5, J6, J7, J9

Applicable Models

All outdoor units

Method of Error Detection

Error is detected from the temperature detected by the thermistor (*1).

Error Decision Conditions

The thermistor has short circuit or open circuit.

Supposed Causes

- Defective thermistor
- Defective outdoor unit main PCB
- Disconnection of thermistor.

Troubleshooting



Caution

Be sure to turn off the power switch before connecting or disconnecting connectors, or parts may be damaged.

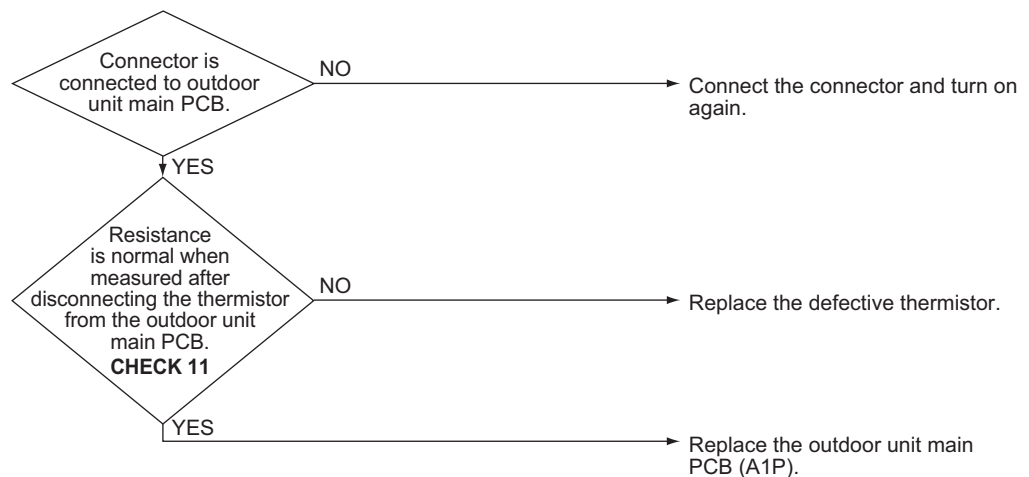

Reference

CHECK 11 Refer to page 348.



Note(s)

*1. Thermistor

Error code	Thermistor	18/24 class		30-48 class	
		Symbol	Connector	Symbol	Connector
H9	Outdoor air thermistor	R1T	X11A	R1T	X11A
J3	Discharge pipe thermistor	R2T	X12A	R2T	X12A
J5	Suction pipe thermistor	R3T		R3T	
		R5T		R5T	
J6	Outdoor heat exchanger deicer thermistor	R4T		R4T	
J7	Outdoor heat exchanger liquid pipe thermistor	R7T	X13A	R7T	X13A
J9	Subcooling heat exchanger gas pipe	—	—	R6T	

5.37 High Pressure Sensor Abnormality

Error Code	JA
Applicable Models	All outdoor units
Method of Error Detection	Error is detected from the pressure detected by the high pressure sensor.
Error Decision Conditions	The high pressure sensor is short circuit or open circuit. Pressure range: 0-4.3 MPa (0-624 psi)
Supposed Causes	<ul style="list-style-type: none"> ■ Defective high pressure sensor ■ Connection of low pressure sensor with wrong connection ■ Defective outdoor unit main PCB ■ Disconnection of high pressure sensor

Troubleshooting



Caution

Be sure to turn off the power switch before connecting or disconnecting connectors, or parts may be damaged.

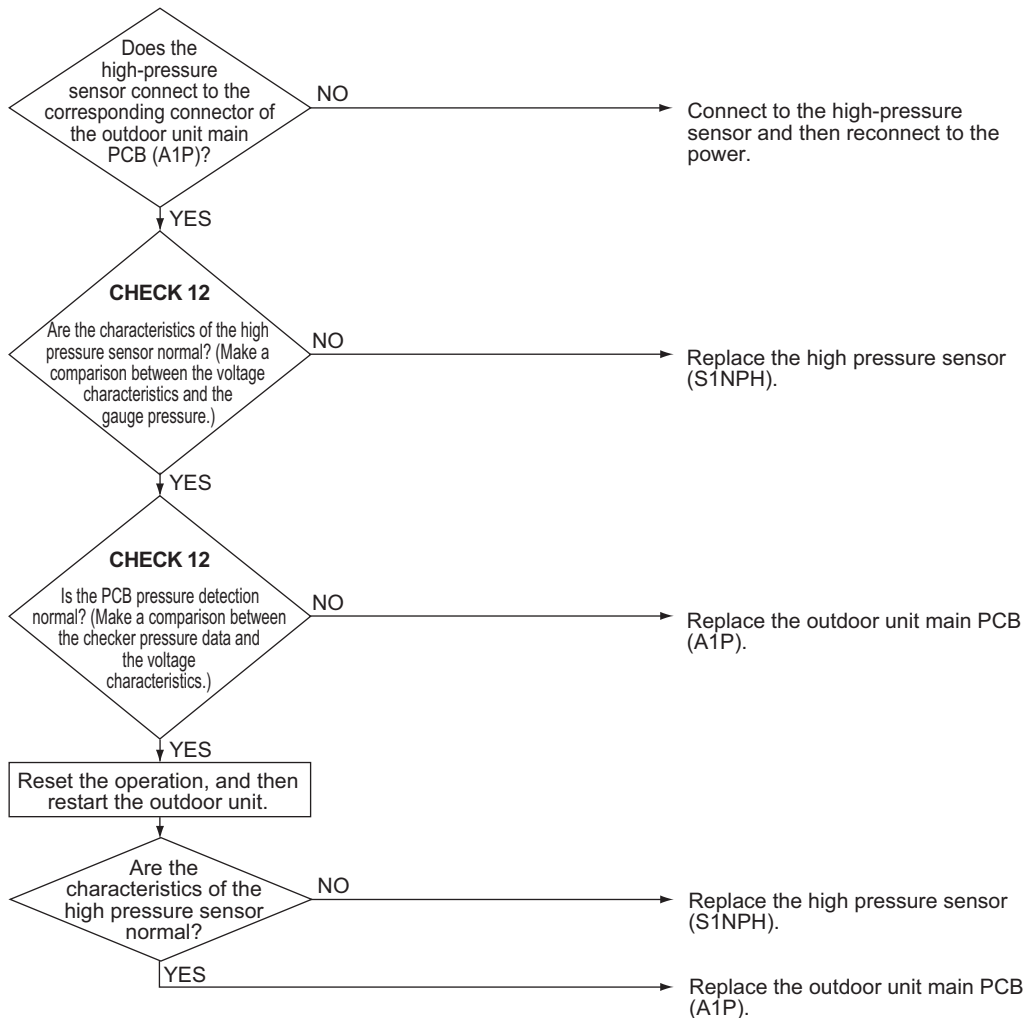

Reference

CHECK 12 Refer to page 351.

5.38 Low Pressure Sensor Abnormality

Error Code

JC

Applicable Models

All outdoor units

Method of Error Detection

Error is detected from pressure detected by low pressure sensor.

Error Decision Conditions

The low pressure sensor is short circuit or open circuit.
Pressure range: 0-1.7 MPa (0-247 psi)

Supposed Causes

- Defective low pressure sensor
- Connection of high pressure sensor with wrong connection
- Defective outdoor main PCB
- Disconnection of low pressure sensor

Troubleshooting



Caution

Be sure to turn off the power switch before connecting or disconnecting connectors, or parts may be damaged.

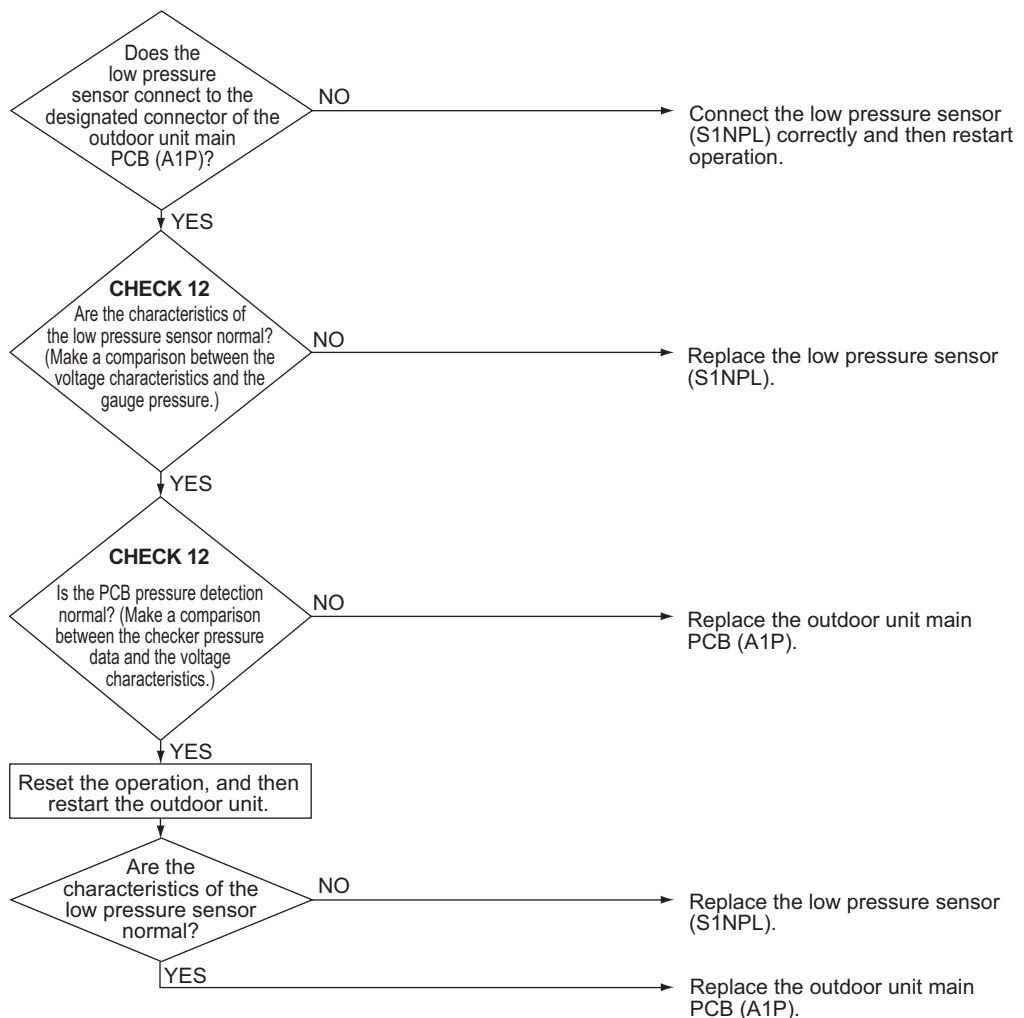

Reference

CHECK 12 Refer to page 351.

5.39 Inverter PCB Abnormality

Error Code	L1
Applicable Models	All outdoor units
Method of Error Detection	<ul style="list-style-type: none"> ■ Error is detected based on the current value during waveform output before starting compressor. ■ Error is detected based on the value from current sensor during synchronous operation when starting the unit.
Error Decision Conditions	<ul style="list-style-type: none"> ■ Overcurrent (OCP) flows during waveform output. ■ Error of current sensor during synchronous operation. ■ IPM failure.
Supposed Causes	<ul style="list-style-type: none"> ■ IPM failure ■ Current sensor failure ■ Drive circuit failure

Troubleshooting



Caution

Be sure to turn off the power switch before connecting or disconnecting connectors, or parts may be damaged.

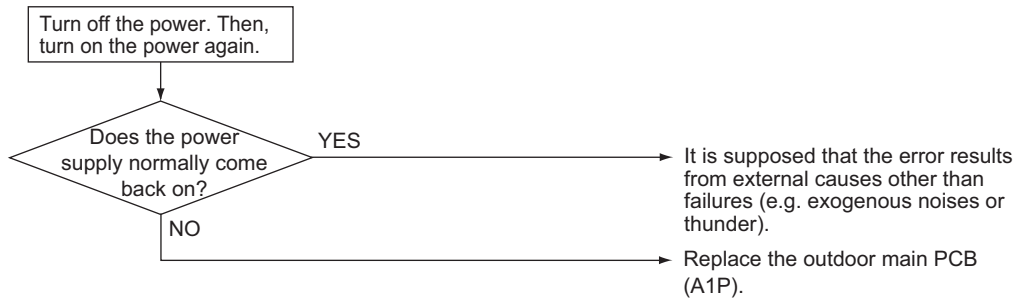

5.40 Radiation Fin Temperature Rise Abnormality

Error Code

L4

Applicable Models

All outdoor units

Method of Error Detection

The radiation fin temperature is detected by the radiation fin thermistor.

Error Decision Conditions

The radiation fin temperature exceeds a certain temperature.

Supposed Causes

- Activation of radiation fin thermistor
- Defective outdoor main PCB
- Defective radiation fin thermistor

Troubleshooting



Caution Be sure to turn off the power switch before connecting or disconnecting connectors, or parts may be damaged.

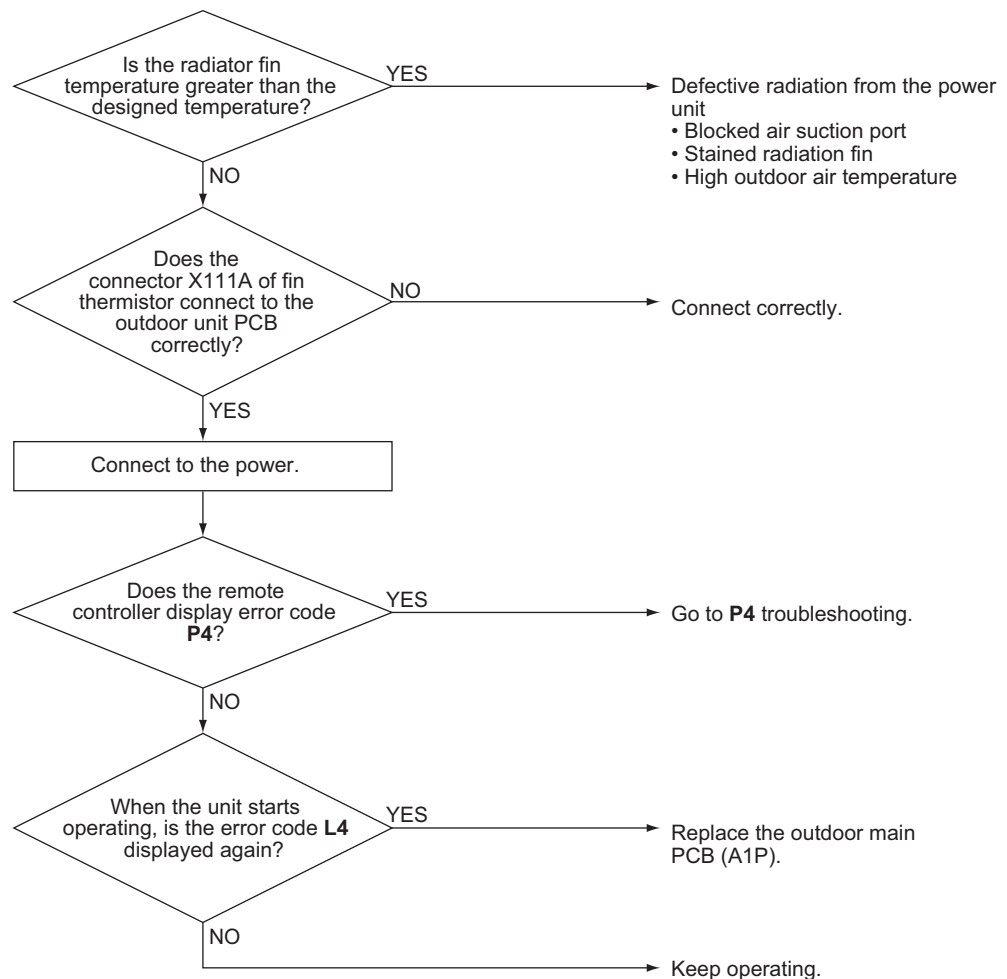

5.41 Compressor Instantaneous Overcurrent

Error Code	L5
Applicable Models	All outdoor units
Method of Error Detection	Error is detected from current flowing in the power transistor.
Error Decision Conditions	An excessive current flows in the power transistor.
Supposed Causes	<ul style="list-style-type: none"> ■ Defective compressor coil (disconnected, defective insulation) ■ Defective compressor startup (mechanical lock) ■ Defective PCB

Troubleshooting



Caution Be sure to turn off the power switch before connecting or disconnecting connectors, or parts may be damaged.

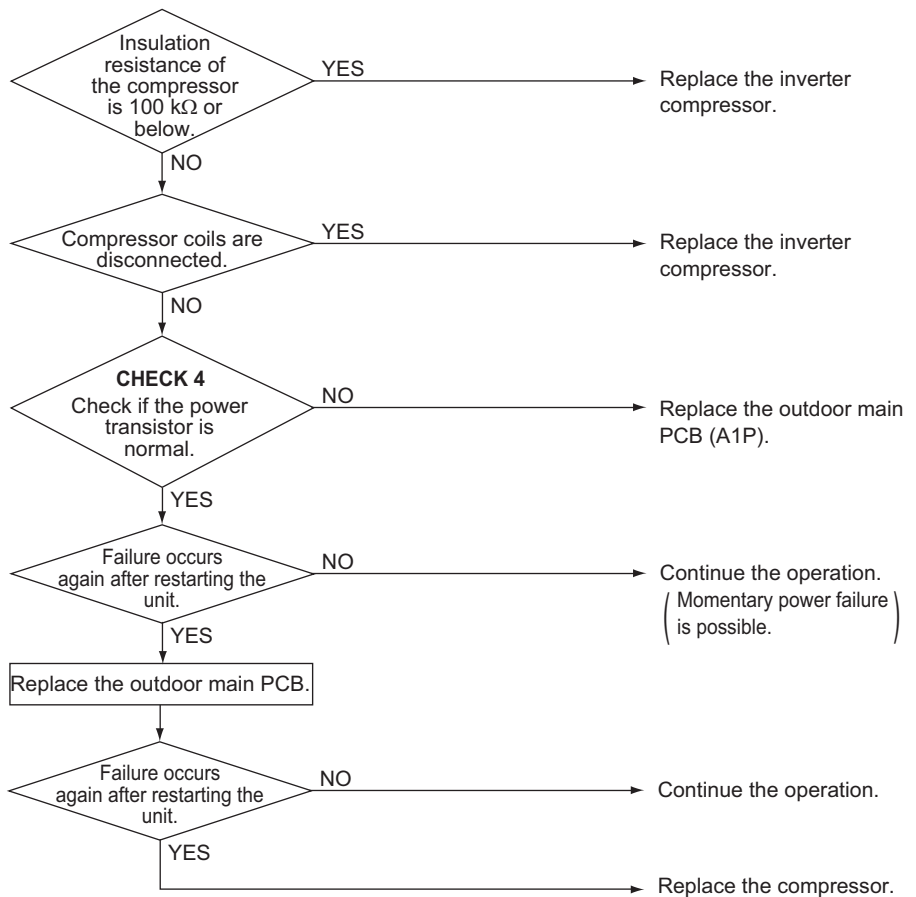

Reference CHECK 4 Refer to page 342.

5.42 Compressor Overcurrent

Error Code	L8
Applicable Models	All outdoor units
Method of Error Detection	Error is detected by current flowing in the power transistor.
Error Decision Conditions	Overload in the compressor is detected.
Supposed Causes	<ul style="list-style-type: none"> ■ Compressor overload ■ Broken wire inside compressor ■ Defective PCB ■ Disconnection of compressor

Troubleshooting



Caution Be sure to turn off the power switch before connecting or disconnecting connectors, or parts may be damaged.

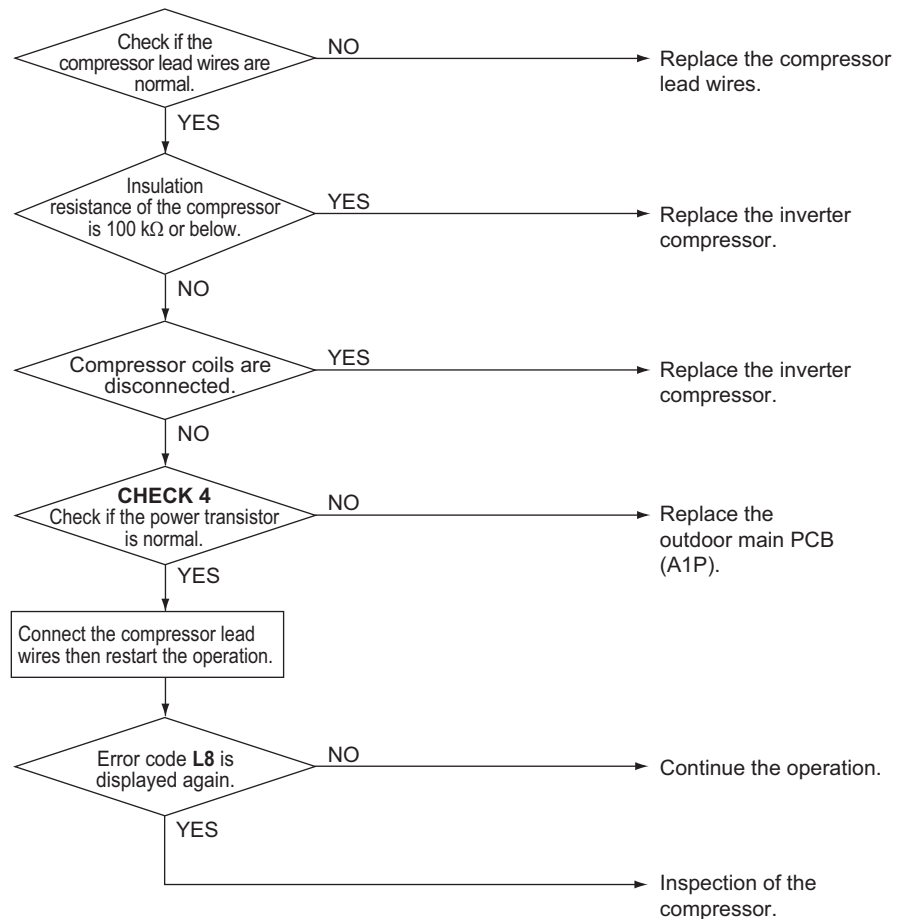

Reference **CHECK 4** Refer to page 342.

5.43 Compressor Startup Abnormality

Error Code	L9
Applicable Models	All outdoor units
Method of Error Detection	Error is detected by the power transistor current
Error Decision Conditions	Compressor overload during activation
Supposed Causes	<ul style="list-style-type: none"> ■ Defective compressor ■ Large pressure difference before starting the compressor ■ Defective PCB

Troubleshooting



Caution Be sure to turn off the power switch before connecting or disconnecting connectors, or parts may be damaged.

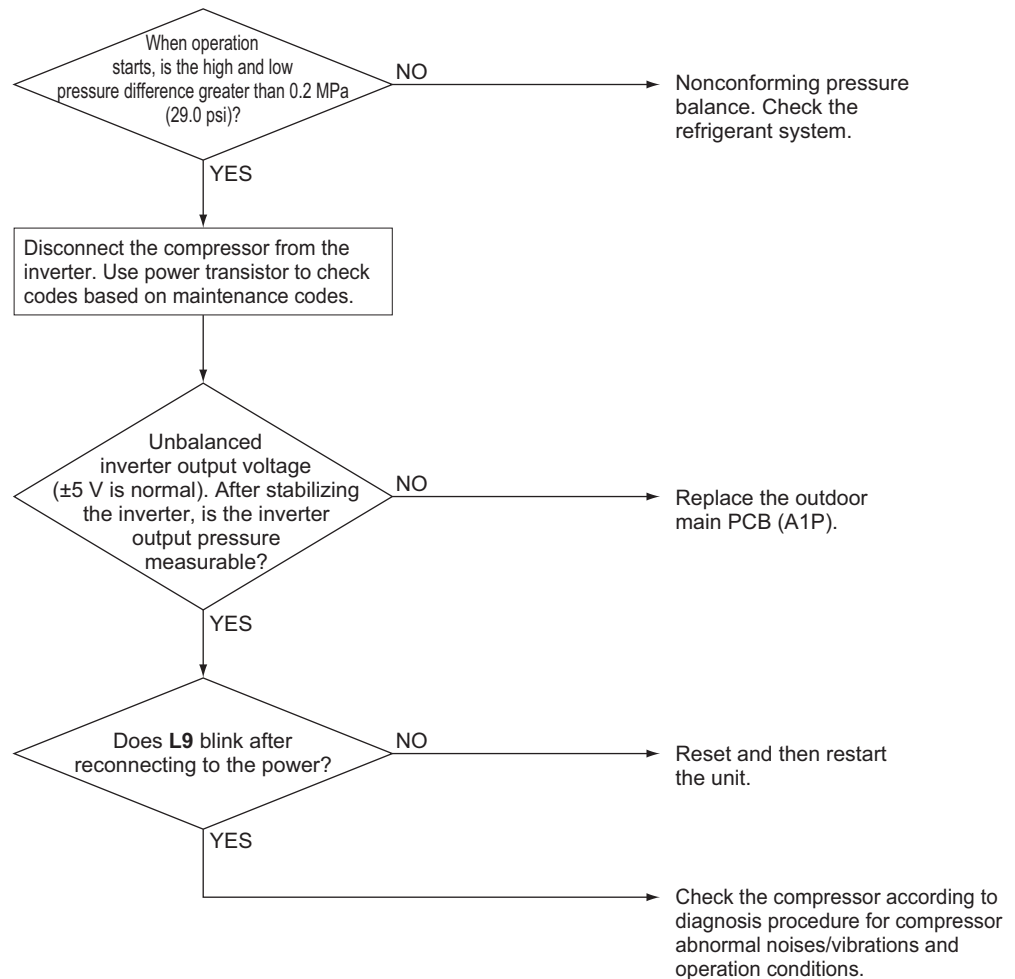

5.44 Transmission Error between Microcomputers on Outdoor Unit Main PCB

Error Code	LC
Applicable Models	All outdoor units
Method of Error Detection	Transmission conditions between microcomputers on the outdoor main PCB are tested via microcomputer.
Error Decision Conditions	No normal transmission after a certain period of time
Supposed Causes	<ul style="list-style-type: none"> ■ Connection error between microcomputers on the outdoor main PCB ■ Defective outdoor main PCB (Transmission part) ■ Defective noise filter ■ External factors (Noise, etc.) ■ Defective inverter compressor ■ Defective fan motor

Troubleshooting

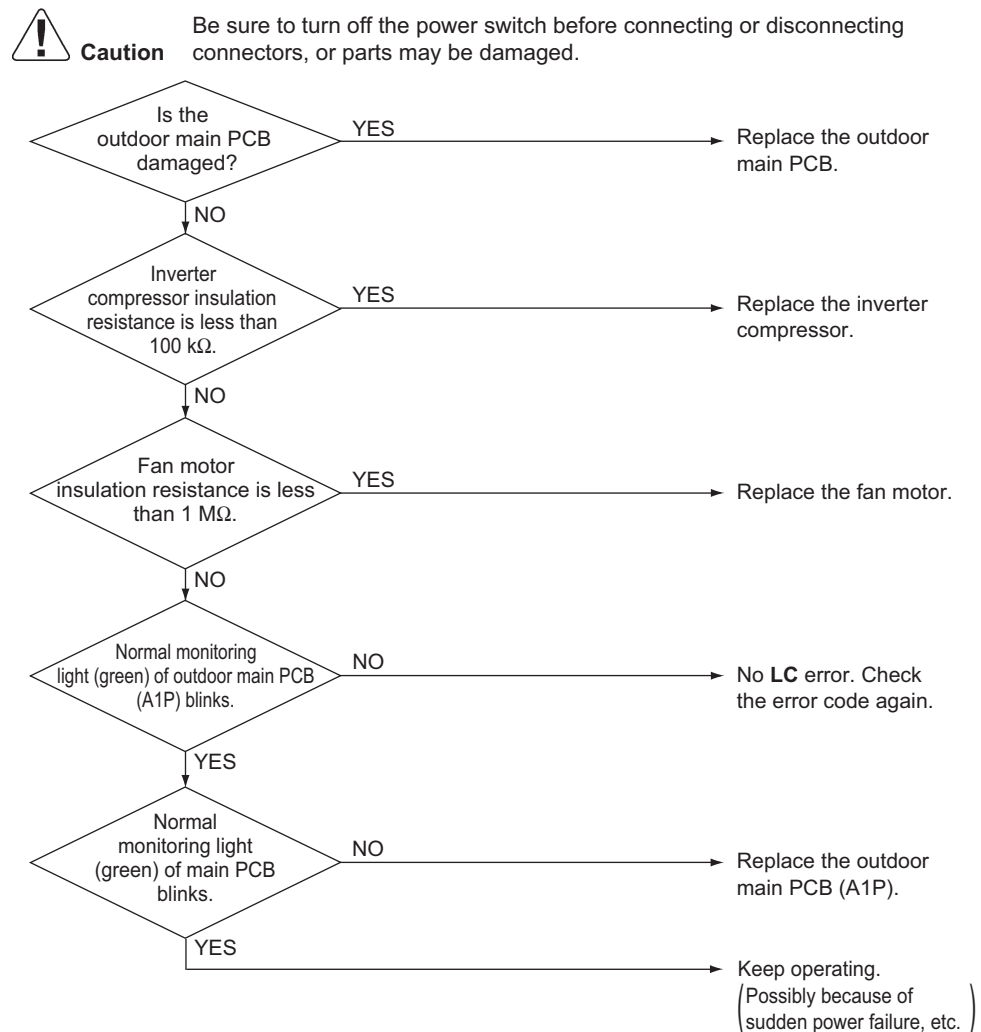

5.45 Inverter Circuit Capacitor High Voltage

Error Code	P1
Applicable Models	All outdoor units
Method of Error Detection	The voltage waveform of the main circuit capacitor of the inverter is used to check for errors.
Error Decision Conditions	The above-mentioned voltage waveform looks like the waveform of the power supply with a missing phase
Supposed Causes	<ul style="list-style-type: none"> ■ Defective main circuit capacitor ■ Incorrect main circuit wiring ■ Defective outdoor unit PCB ■ Unbalanced voltage between phases ■ Missing phase

Troubleshooting



Caution

Be sure to turn off the power switch before connecting or disconnecting connectors, or parts may be damaged.

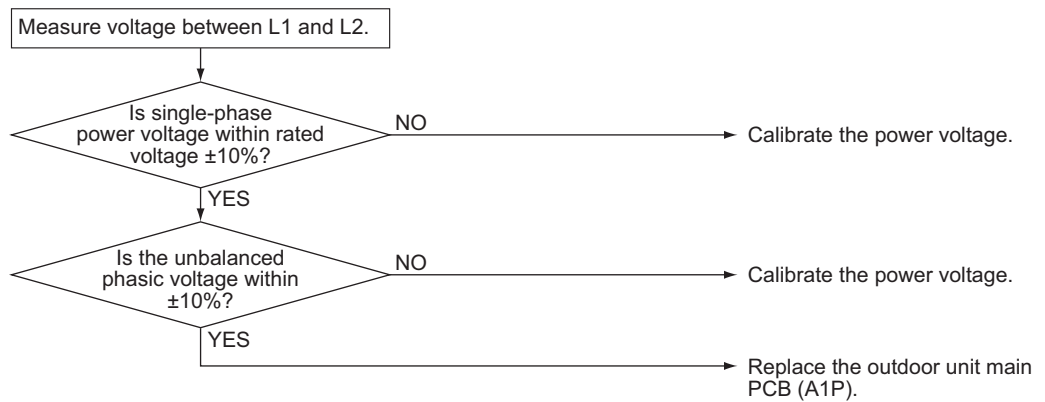

5.46 Radiation Fin Thermistor Abnormality

Error Code	P4
Applicable Models	All outdoor units
Method of Error Detection	Resistance of the following thermistor is detected when the compressor is not operating. (1) Radiation fin thermistor (2) PCB circuit thermistor
Error Decision Conditions	When the resistance value of thermistor becomes a value equivalent to open circuited or short circuited status * Error is not decided while the unit operation is continued. P4 will be displayed by pressing the inspection button.
Supposed Causes	<ul style="list-style-type: none"> ■ Defective radiation fin temperature thermistor ■ Defective PCB ■ Defective inverter compressor ■ Defective fan motor
Troubleshooting	

**Caution**

Be sure to turn off the power switch before connecting or disconnecting connectors, or parts may be damaged.

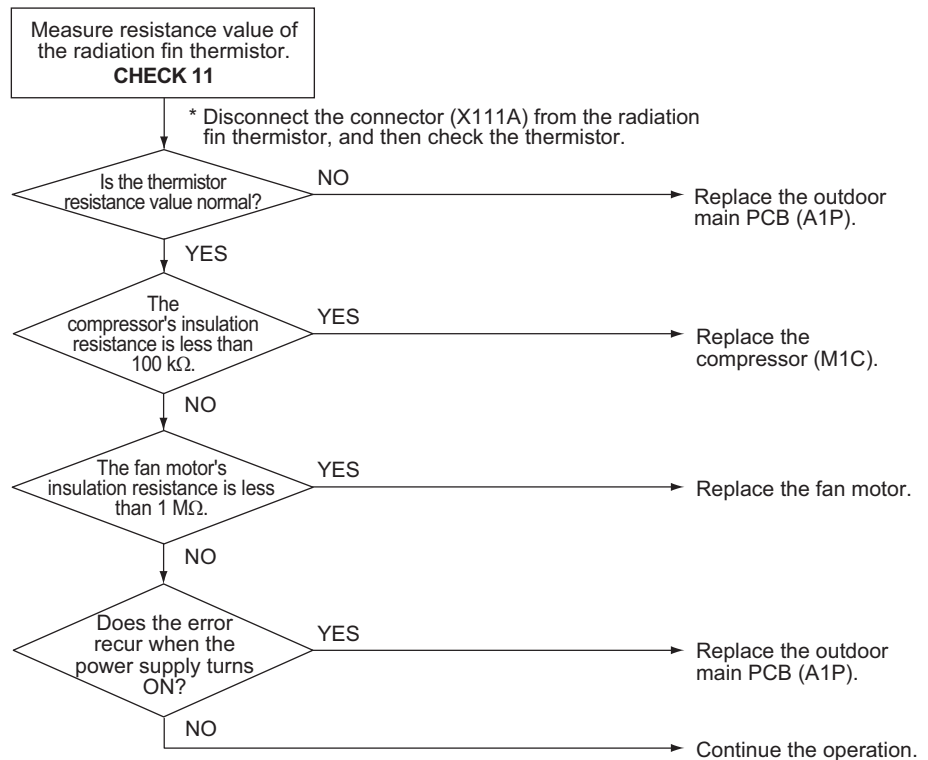
**Reference**

CHECK 11 Refer to page 348.

5.47 Refrigerant Shortage

Error Code	U0
Applicable Models	All outdoor units
Method of Error Detection	Refrigerant shortage check is conducted based on the discharge pipe thermistor temperature and the low-pressure saturated temperature.
Error Decision Conditions	Microcomputer is used to determine and check for system refrigerant shortage. *The unit can keep operating but there is an unconfirmed error.
Supposed Causes	<ul style="list-style-type: none"> ■ Refrigerant shortage or refrigerant clogging (piping error) ■ Defective suction pipe thermistor ■ Defective pressure sensor ■ Defective outdoor main PCB (A1P)

Troubleshooting



Caution Be sure to turn off the power switch before connecting or disconnecting connectors, or parts may be damaged.

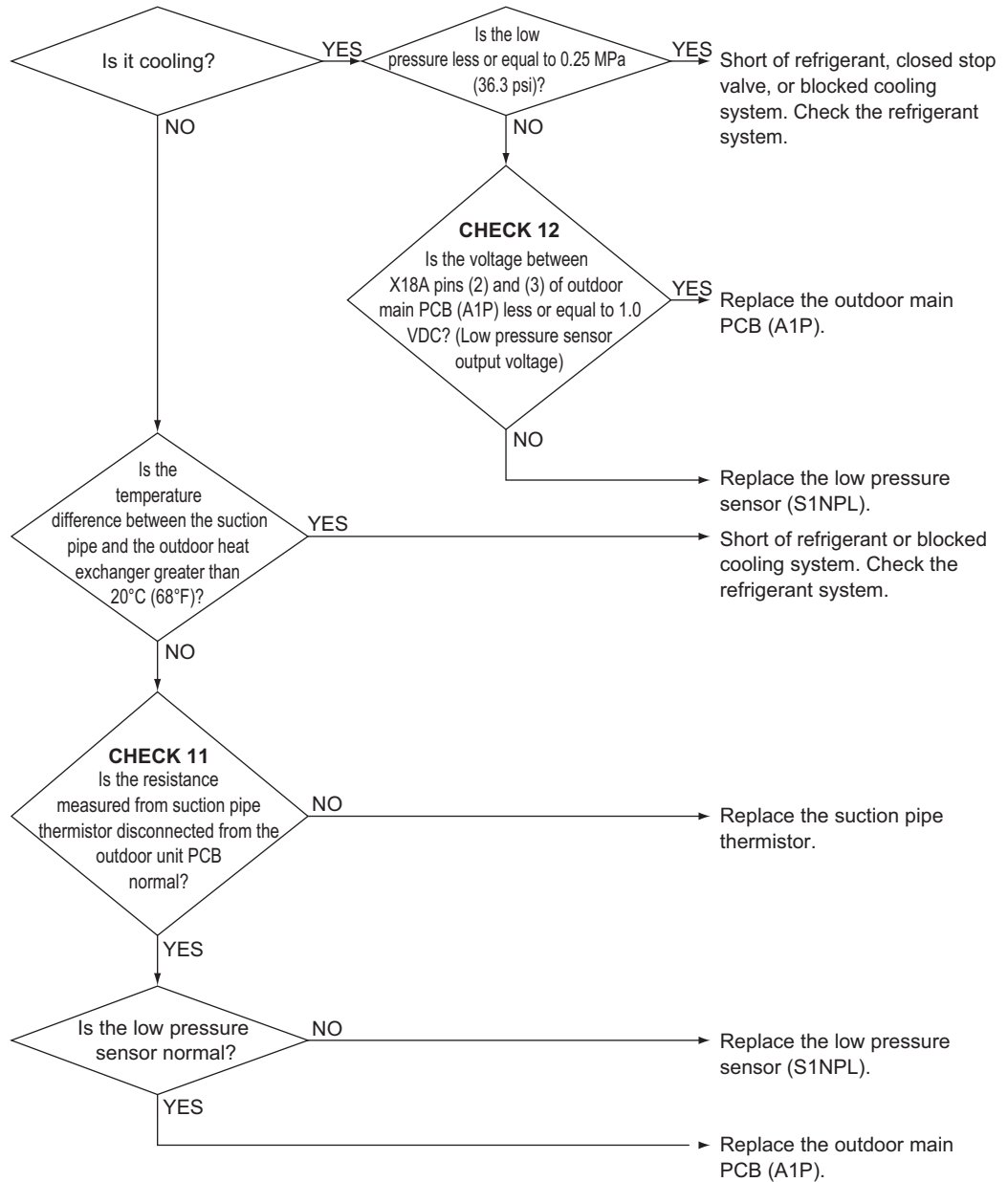

Reference CHECK 11 Refer to page 348.



Reference CHECK 12 Refer to page 351.

5.48 Power Supply Insufficient or Instantaneous Abnormality

Error Code	U2
Applicable Models	All outdoor units
Method of Error Detection	The main circuit capacitor voltage of the inverter and the power supply voltage is checked.
Error Decision Conditions	The main circuit capacitor of the tested inverter has abnormal voltage or the power supply voltage is abnormal.
Supposed Causes	<ul style="list-style-type: none">■ Insufficient power supply■ Instantaneous power failure■ Defective outdoor fan motor■ Defective outdoor unit PCB

Troubleshooting



Caution Be sure to turn off the power switch before connecting or disconnecting connectors, or parts may be damaged.

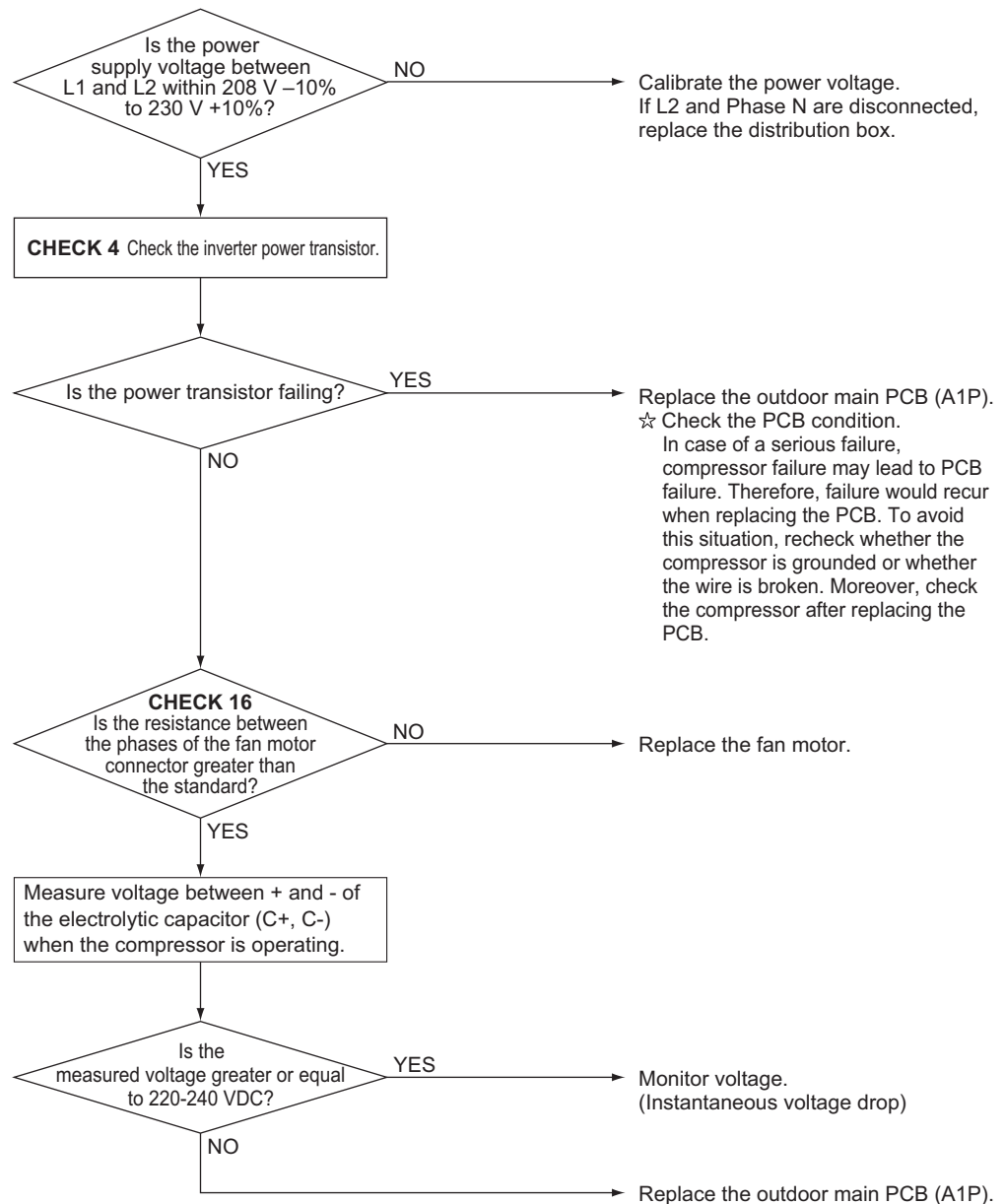

Reference **CHECK 4** Refer to page 342.



Reference **CHECK 16** Refer to page 353.

5.49 Check Operation Not Executed

Error Code	U3
Applicable Models	All outdoor units
Method of Error Detection	Determined based on whether check operation is executed or not
Error Decision Conditions	Error is decided when the unit starts operation without check operation.
Supposed Causes	Check operation not executed

Troubleshooting



Caution

Be sure to turn off the power switch before connecting or disconnecting connectors, or parts may be damaged.

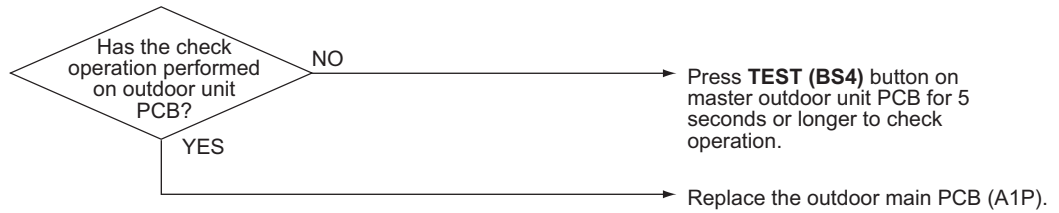

5.50 Transmission Error between Indoor Units and Outdoor Units

Error Code	U4
Applicable Models	All indoor and outdoor units
Method of Error Detection	Microcomputer checks if transmission between indoor and outdoor units is normal.
Error Decision Conditions	When transmission is not carried out normally for a certain amount of time
Supposed Causes	<ul style="list-style-type: none"> ■ Indoor to outdoor transmission wiring F1, F2 disconnection, short circuit or wrong wiring ■ Outdoor unit power supply is OFF ■ System address does not match ■ Defective indoor unit PCB ■ Defective outdoor main PCB

Troubleshooting

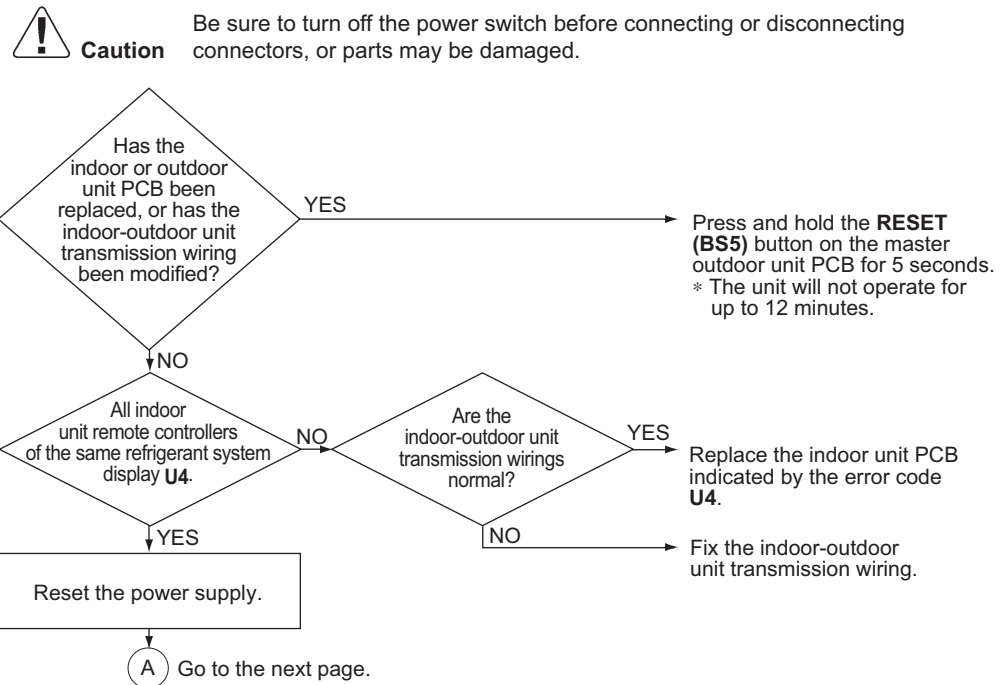

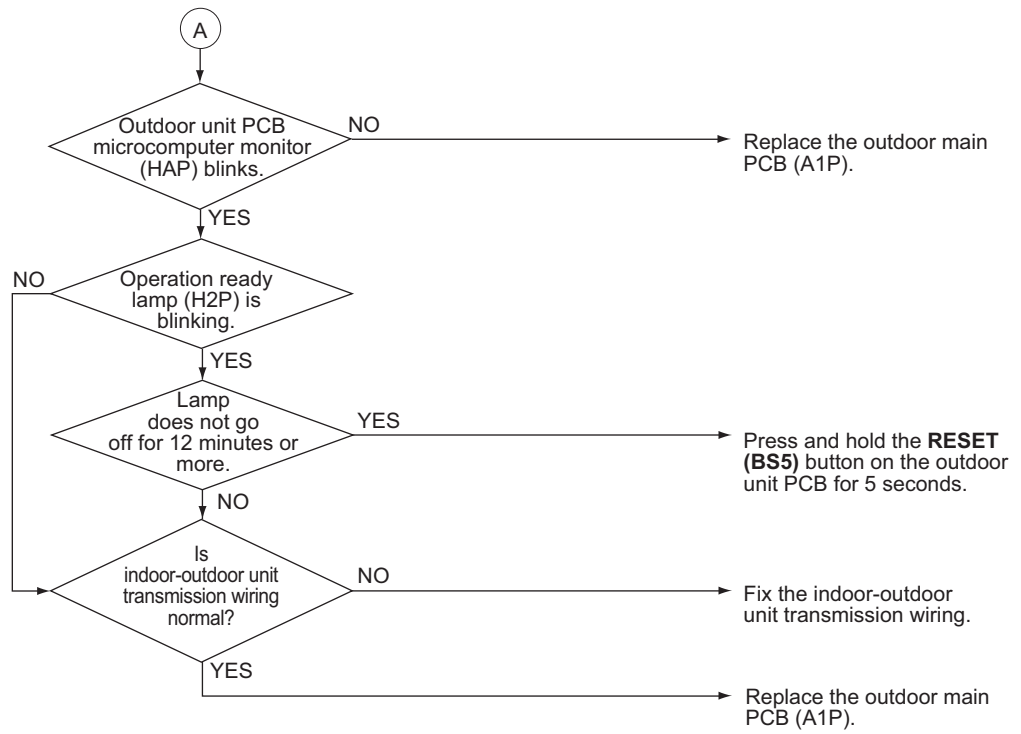

5.51 Transmission Error between Remote Controller and Indoor Unit

Error Code	U5
Applicable Models	All indoor units
Method of Error Detection	Microcomputer checks if transmission between indoor unit and remote controller is normal.
Error Decision Conditions	Normal transmission does not continue for specified period.
Supposed Causes	<ul style="list-style-type: none"> ■ Transmission error between indoor unit and remote controller ■ Connection of 2 main remote controllers (when using 2 remote controllers) ■ Defective indoor unit PCB ■ Defective remote controller PCB ■ Defective transmission caused by noise

Troubleshooting

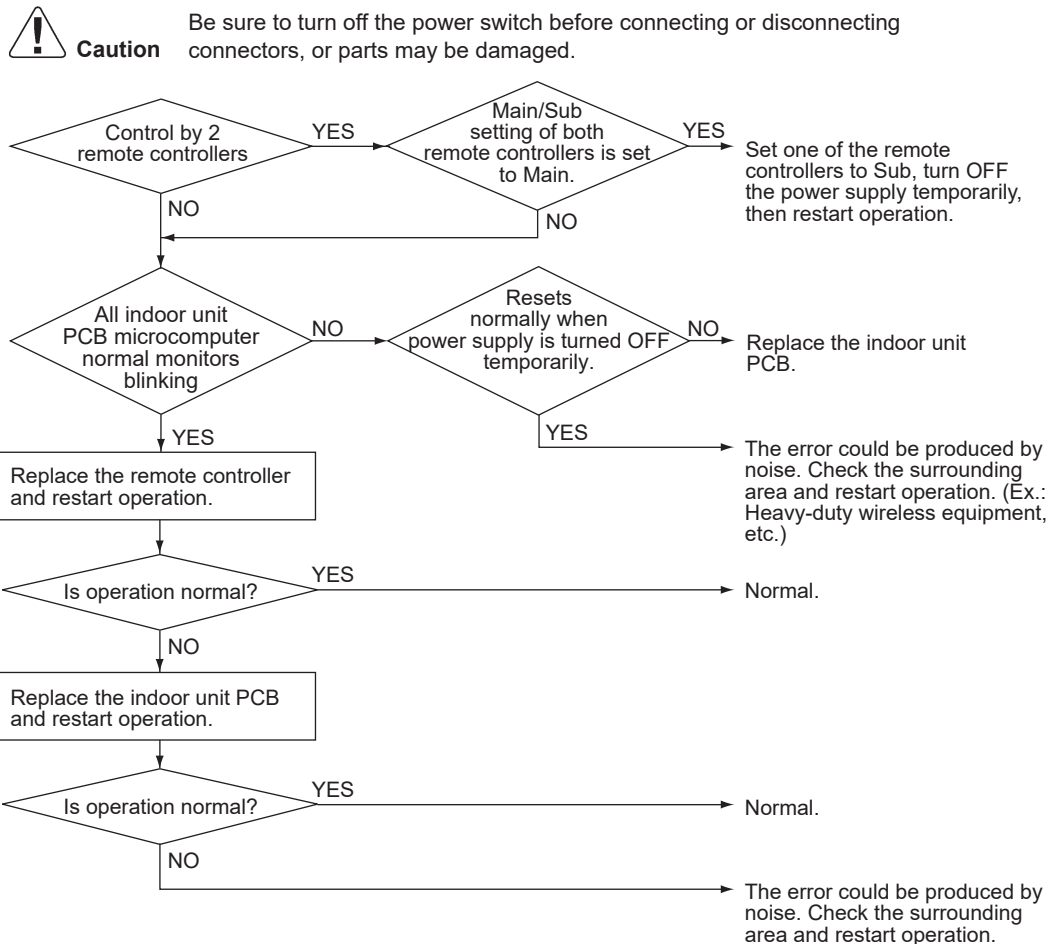

Reference

Refer to page 123 for Main/Sub setting.

5.52 Transmission Error between Main and Sub Remote Controllers

Error Code	U8
Applicable Models	All indoor units
Method of Error Detection	In case of controlling with 2 remote controllers, check the system using microcomputer if signal transmission between indoor unit and remote controller (main and sub) is normal.
Error Decision Conditions	Normal transmission does not continue for specified period.
Supposed Causes	<ul style="list-style-type: none"> ■ Transmission error between main and sub remote controller ■ Connection between sub remote controllers ■ Defective remote controller PCB

Troubleshooting



Caution

Be sure to turn off the power switch before connecting or disconnecting connectors, or parts may be damaged.

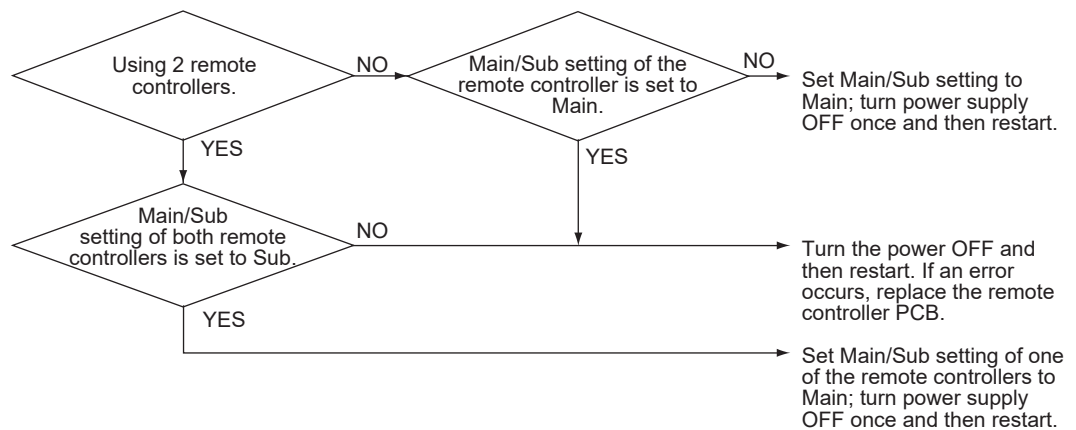

Reference

Refer to page 123 for Main/Sub setting.

5.53 Transmission Error between Indoor and Outdoor Units in the Same System

Error Code	U9
Applicable Models	All indoor units All outdoor units
Method of Error Detection	Error signal for the other indoor units is detected within the system by outdoor unit PCB.
Error Decision Conditions	The error decision is made on any other indoor unit within the system concerned.
Supposed Causes	<ul style="list-style-type: none"> ■ Transmission error within or outside of other system ■ Defective electronic expansion valve in indoor unit of other system ■ Defective PCB of indoor unit in other system ■ Improper connection of transmission wiring between indoor and outdoor unit

Troubleshooting

Caution

Be sure to turn off the power switch before connecting or disconnecting connectors, or parts may be damaged.

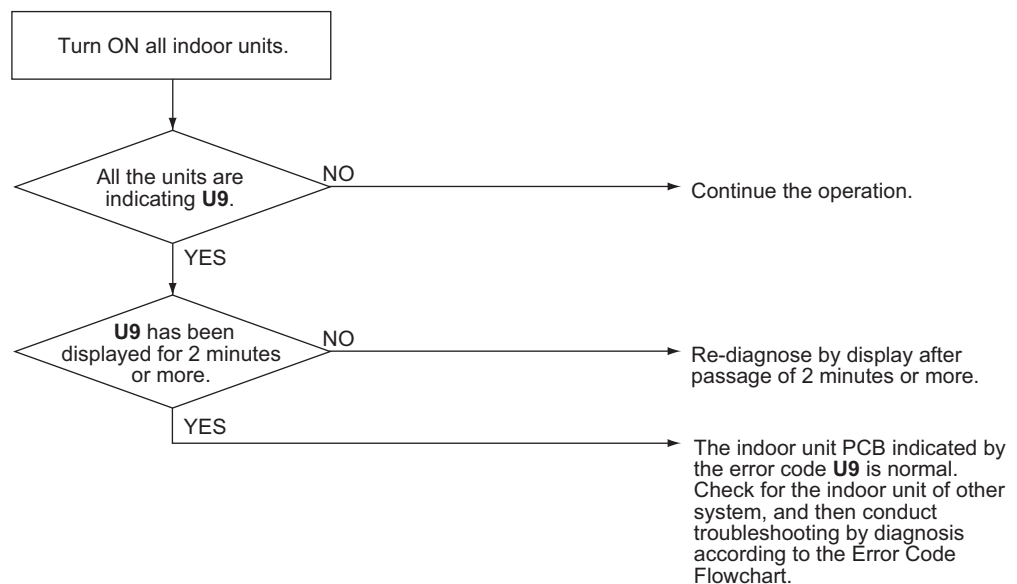

5.54 Improper Combination of Indoor and Outdoor Units, Indoor Units and Remote Controller

Error Code	UA
Applicable Models	All indoor units All outdoor units
Method of Error Detection	A difference occurs in data by the type of refrigerant between indoor and outdoor units. The number of indoor units is out of the allowable range.
Error Decision Conditions	The error decision is made as soon as either of the abnormalities aforementioned is detected.
Supposed Causes	<ul style="list-style-type: none"> ■ Excess of connected indoor units ■ Defective outdoor main PCB ■ Mismatching of the refrigerant type of indoor and outdoor unit. ■ Setting of outdoor main PCB was not conducted after replacing to spare PCB.

Troubleshooting



Caution Be sure to turn off the power switch before connecting or disconnecting connectors, or parts may be damaged.

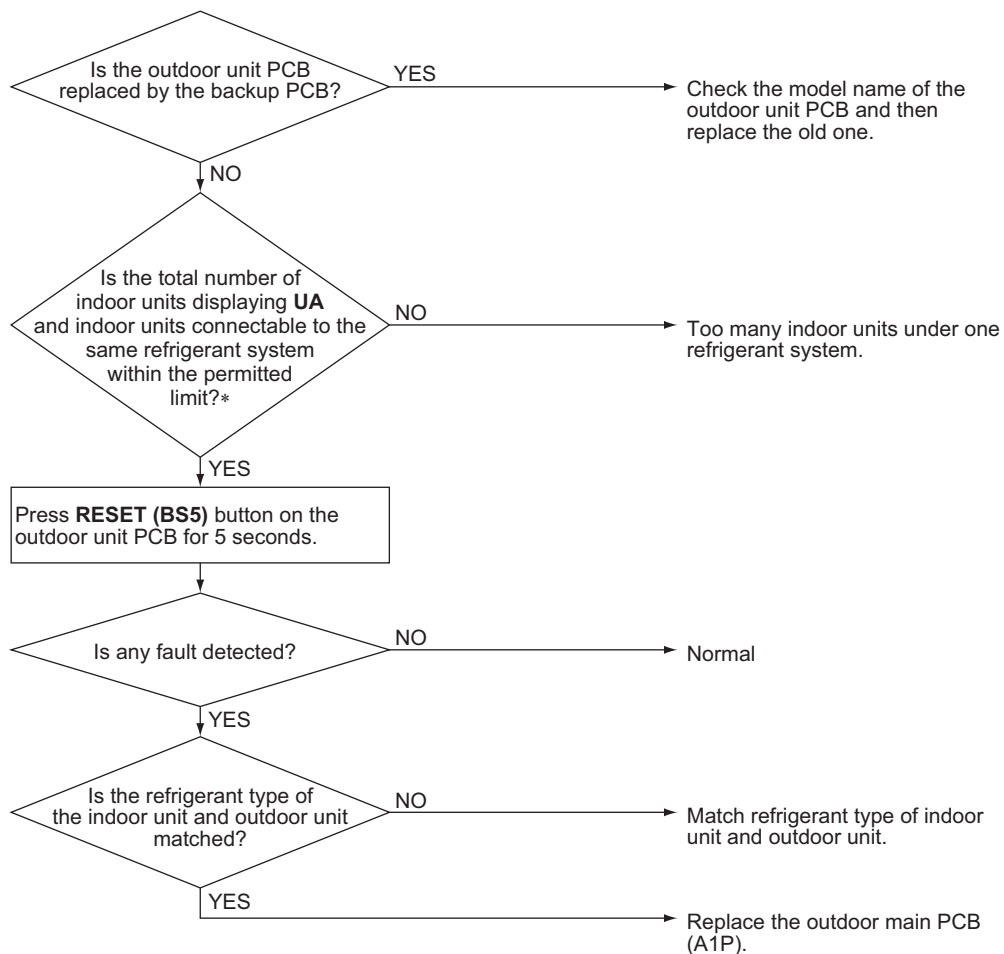

* The number of indoor units that may be connected to an individual outdoor unit system is determined by the model of the outdoor unit.

5.55 Incorrect Electric Heater Capacity Setting

Error Code	UA-17
Applicable Models	FTQ-TA
Outline	<p>After attaching optional electric heater, if the electric heater capacity setting (11 (21)-5) is made mistakenly for heaters not featured in the lineup, heating via unintended levels of airflow will be prevented.</p> <p>However, the electric heater will be operable for convenience.</p>
Error Decision Conditions	Checks when the capacity setting (11 (21)-5) of the electric heater has been set to a non-applicable value.
Operation After Error Codes Decided	<ul style="list-style-type: none"> ■ The error code UA-17 is displayed on the remote controller. ■ Indoor units can operate continuously. ■ Incorrect setting is kept. ■ Even if the ON condition for electric heater 2 is established, only electric heater 1 will be set to ON. (Electric heater 1 set to ON, electric heater 2 set to OFF) (In order to deliver in terms of user-friendliness and safety, the electric heater can operate at the lowest possible power levels.) ■ The airflow of the fan during operation of the electric heater will be set to the largest value within the CFM dictated by the capacity of each of the electric heaters (electric heater 1, electric heater 2 both set to ON). ■ All other operations are the same as during normal operation.

5.56 Address Duplication of Centralized Controller

Error Code	UC
Applicable Models	All indoor units
Method of Error Detection	The principal indoor unit detects the same address as that of its own on any other indoor unit.
Error Decision Conditions	The error decision is made as soon as the abnormality aforementioned is detected.
Supposed Causes	<ul style="list-style-type: none"> ■ Address duplication of centralized controller ■ Defective indoor unit PCB
Troubleshooting	

**Caution**

Be sure to turn off the power switch before connecting or disconnecting connectors, or parts may be damaged.

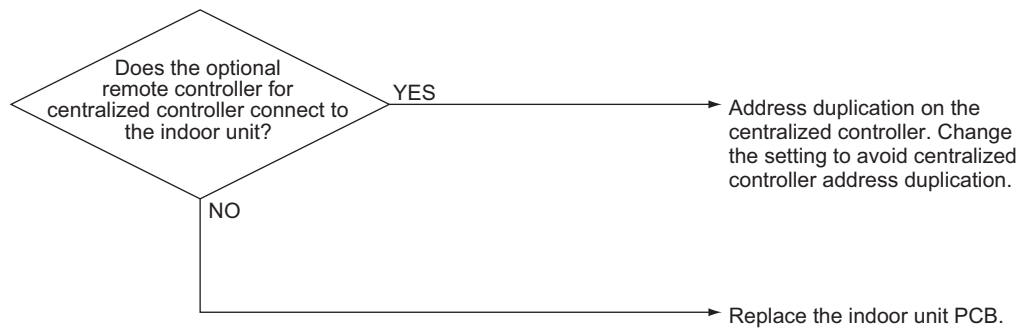

5.57 Transmission Error between Centralized Controller and Indoor Unit

Error Code	UE
Applicable Models	All indoor units Centralized controller
Method of Error Detection	Microcomputer checks if transmission between indoor unit and centralized controller is normal.
Error Decision Conditions	When transmission is not carried out normally for a certain amount of time
Supposed Causes	<ul style="list-style-type: none"> ■ Disconnection or error of transmission wiring ■ Defective setting of group No. or address ■ Transmission error between optional controllers for centralized control and indoor unit ■ Defective PCB for centralized controller ■ Defective indoor unit PCB

Troubleshooting

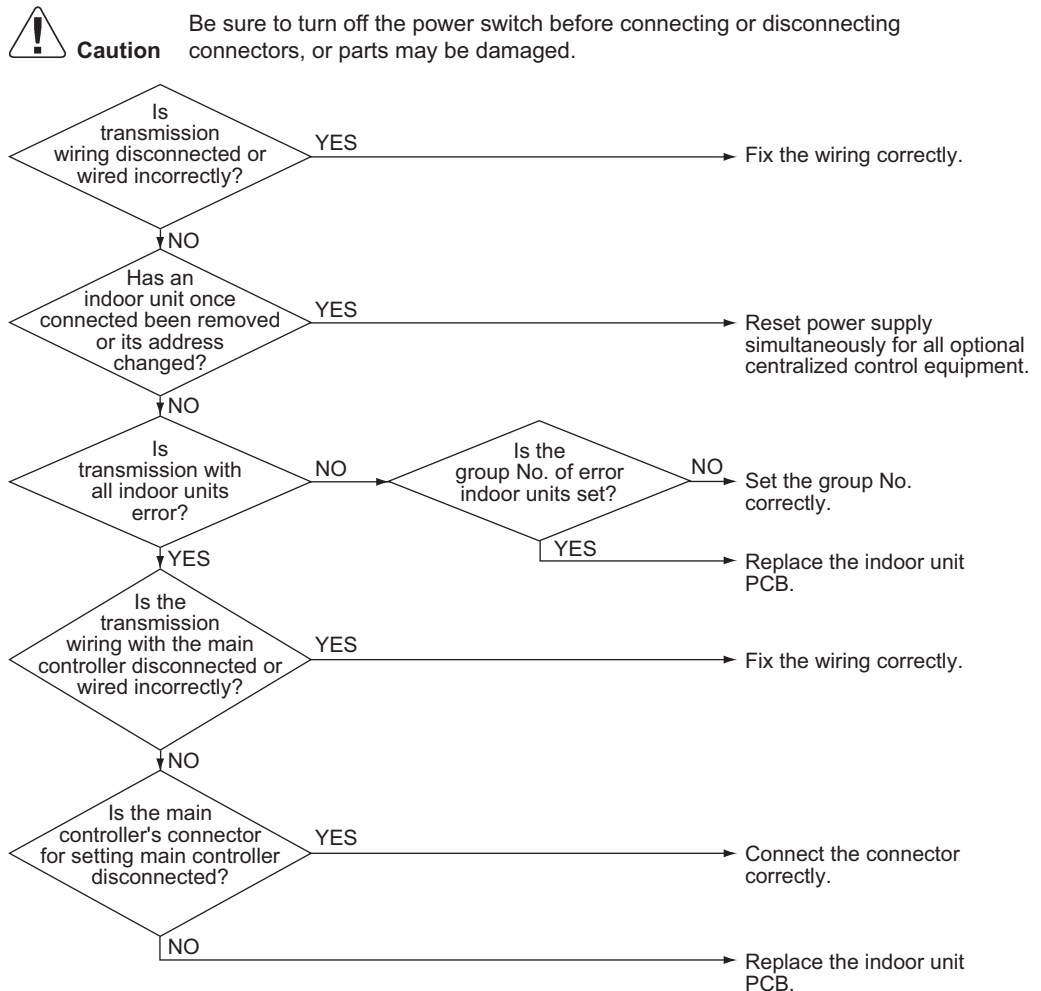

5.58 System Not Set

Error Code	UF
Applicable Models	All indoor units All outdoor units
Method of Error Detection	On check operation, the number of indoor units in terms of transmission is not corresponding to that of indoor units that have made changes in temperature.
Error Decision Conditions	The error is determined as soon as the abnormality aforementioned is detected through checking the system for any erroneous connection of units on the check operation.
Supposed Causes	<ul style="list-style-type: none"> ■ Improper connection of transmission wiring between indoor-outdoor units ■ Failure to execute check operation ■ Defective indoor unit PCB ■ Stop valve is not opened

Troubleshooting

Caution

Be sure to turn off the power switch before connecting or disconnecting connectors, or parts may be damaged.

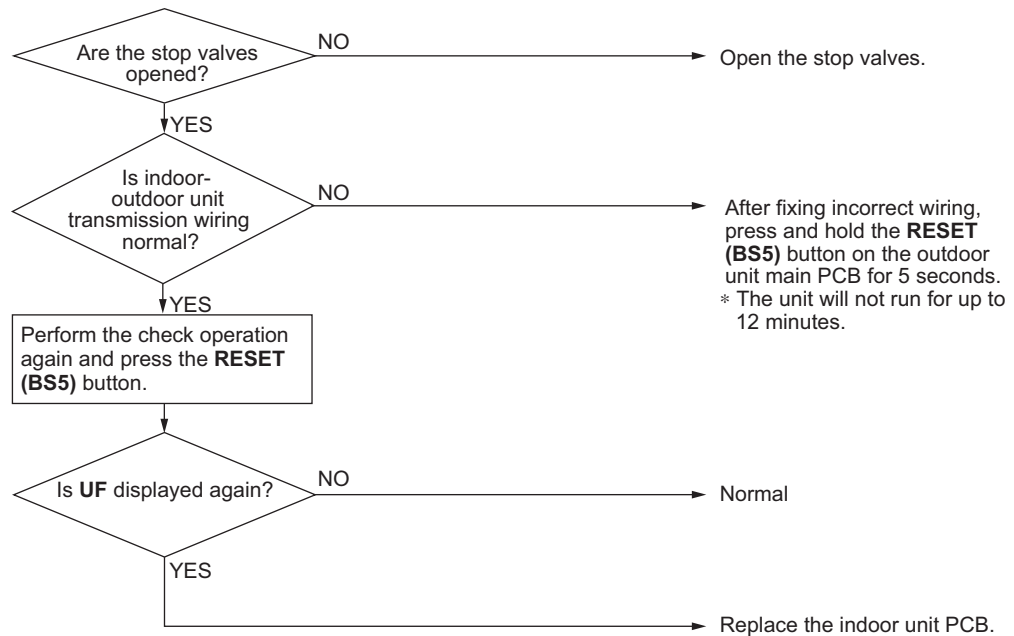

5.59 System Abnormality, Refrigerant System Address Undefined

Error Code	UH
Applicable Models	All indoor units All outdoor units
Method of Error Detection	System detects an indoor unit whose address is not defined by automatic address function. *Automatic address refers to the automatic designated address of indoor unit and outdoor unit when connected to the power after installation or wiring replacement (with the RESET (BS5) button pressed for more than 5 seconds).
Error Decision Conditions	The error decision is made as soon as the abnormality aforementioned is detected.
Supposed Causes	<ul style="list-style-type: none"> ■ Improper connection of transmission wiring between indoor-outdoor units ■ Defective indoor unit PCB ■ Defective outdoor unit main PCB (A1P)

Troubleshooting



Caution

Be sure to turn off the power switch before connecting or disconnecting connectors, or parts may be damaged.

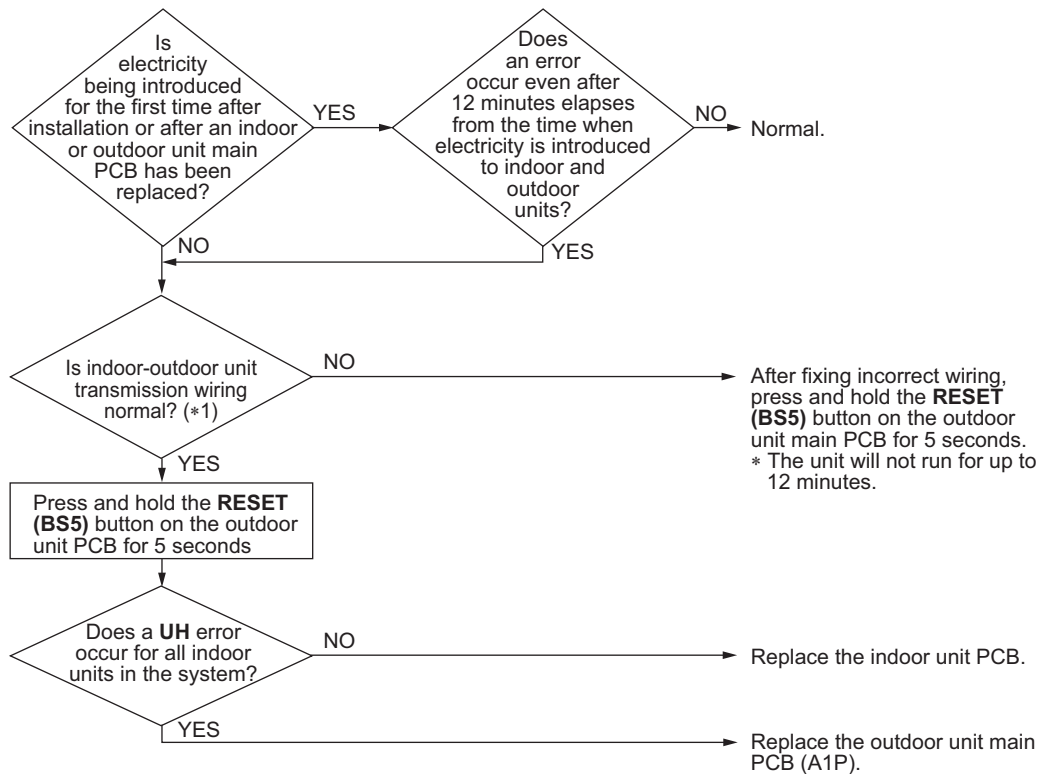

Note(s)

*1. Refer to installation manual for correct "indoor unit and outdoor unit connection wiring".

6. Check

6.1 High Pressure Check

CHECK 1

Referring to the Fault Tree Analysis (FTA) shown below, probe the defective points.

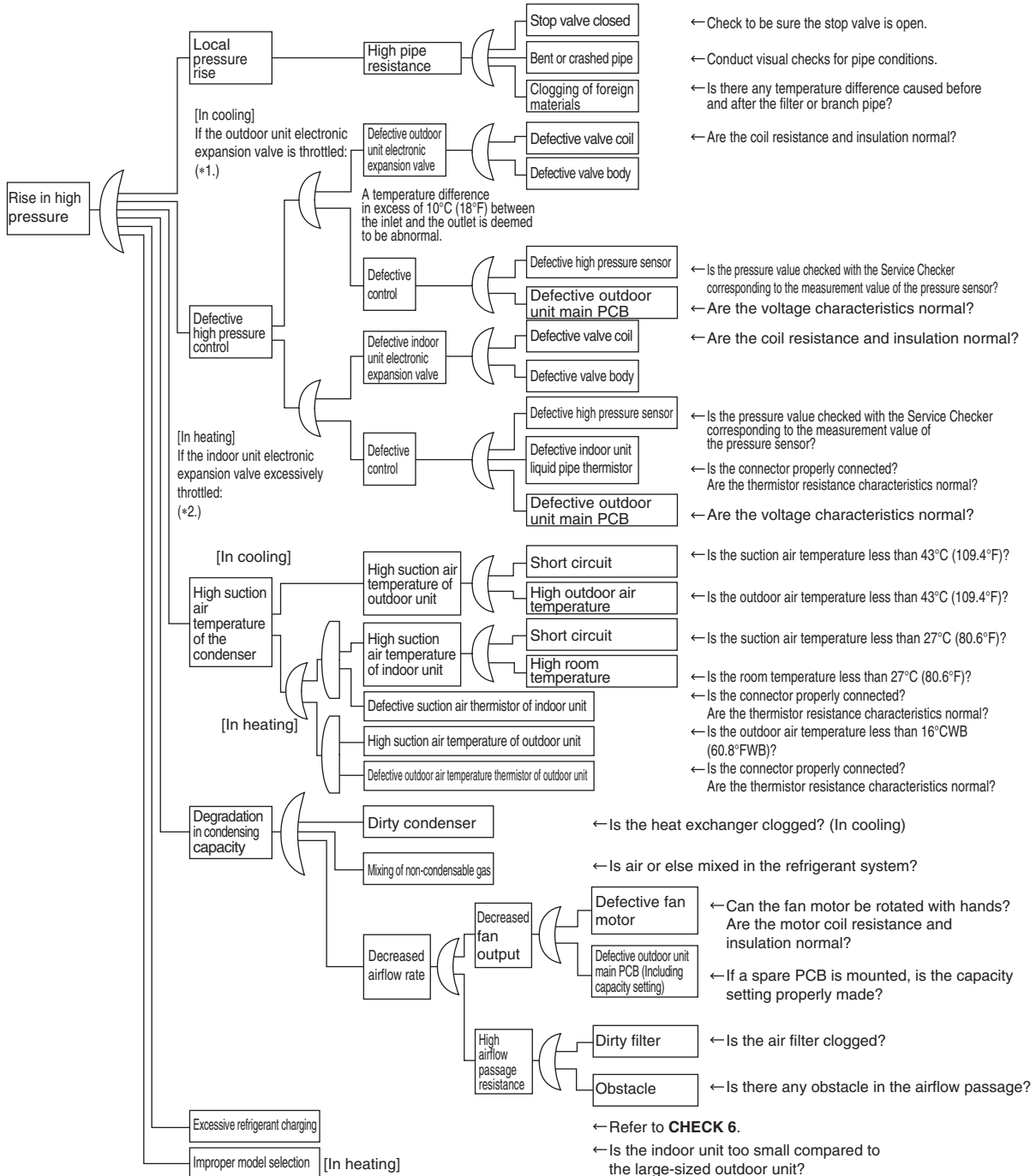

i Note(s)

- *1. In cooling, it is normal if the outdoor unit electronic expansion valve (main) is fully open.
- *2. In heating, the indoor unit electronic expansion valve is used for subcooling degree control.

Reference

CHECK 6 Refer to page 343.

6.2 Low Pressure Check

CHECK 2

Referring to the Fault Tree Analysis (FTA) shown below, probe the defective points

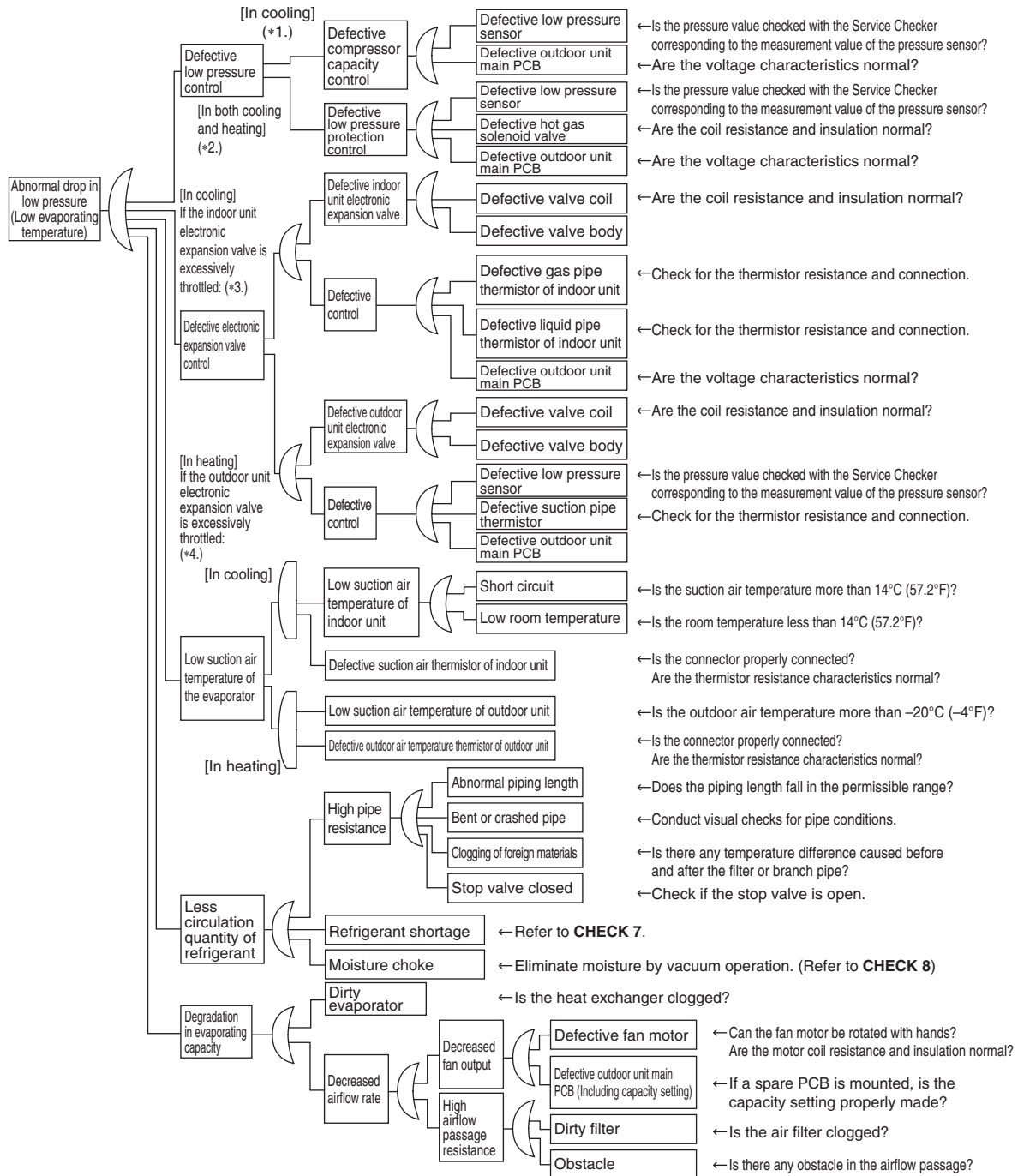

i Note(s)

- *1. For details of compressor capacity control while in cooling, refer to Compressor PI control.
- *2. The low pressure protection control includes low pressure protection control and hot gas bypass control.
- *3. In cooling, the indoor unit electronic expansion valve is used for superheating degree control.
- *4. In heating, the outdoor unit electronic expansion valve (main) is used for superheating degree control of outdoor heat exchanger.



Reference **CHECK 7** Refer to page 344.



Reference **CHECK 8** Refer to page 345.

6.3 Superheat Operation Check

CHECK 3

Referring to the Fault Tree Analysis (FTA) shown below, probe the defective points.

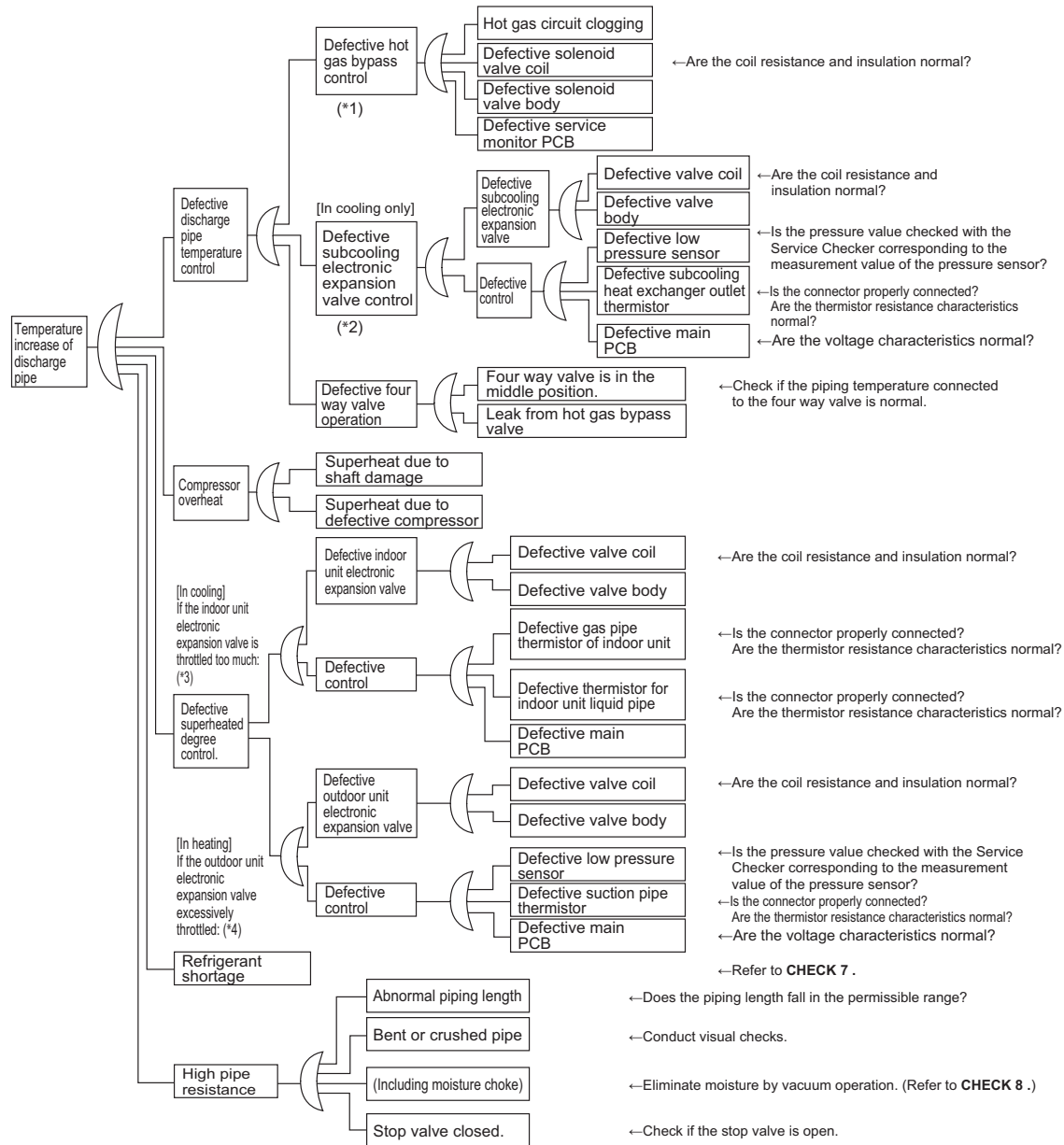

i Note(s)

- *1: Refer to Low pressure protection control on page 154.
- *2: Refer to Subcooling electronic expansion valve control on page 145.
- *3: Superheating temperature control in cooling is conducted by indoor unit electronic expansion valve.
- *4: Superheating temperature control in heating is conducted by outdoor unit electronic expansion valve.
- *5: Judgment criteria of superheat operation: (1) Suction gas superheated degree: 10°C (18°F) and over. (2) Discharge gas superheated degree: 45°C (81°F) and over, except immediately after compressor starts up or is running under dropping control. (Use the above values as a guide. Depending on the other conditions, the unit may be normal despite the values within the above range.)



Reference **CHECK 7** Refer to page 344.



Reference **CHECK 8** Refer to page 345.

6.4 Power Transistor Check

CHECK 4

Perform the following procedures prior to check.

- (1) Power OFF.
- (2) Remove all the wiring connected to the PCB where power transistors are mounted on.

[Preparation]

· Multimeter

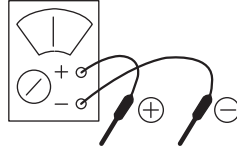

* Preparing a multimeter in the analog system is recommended.

A multimeter in the digital system with diode check function will be usable.

[Point of Measurement and Judgment Criteria]

· Measure the resistance value using a tester at each point of measurement below, 10 minutes later after power OFF.

To use analog multimeter:

Measurement in the resistance value mode in the range of multiplying 1 k Ω .

No.	Point of Measurement		Judgment Criteria	Remarks
	+	-		
1	P2	U	2 ~ 15 k Ω	—
2	P2	V		
3	P2	W		
4	U	P2	15 k Ω and above (including ∞)	Due to condenser charge and so on, resistance measurement may require some time.
5	V	P2		
6	W	P2		
7	N3	U		
8	N3	V		
9	N3	W	2 ~ 15 k Ω	—
10	U	N3		
11	V	N3		
12	W	N3		

To use digital multimeter:

Measurement is executed in the diode check mode.(→|←)

No.	Point of Measurement		Judgment Criteria	Remarks
	+	-		
1	P2	U	1.2 V and over	Due to condenser charge and so on, resistance measurement may require some time.
2	P2	V		
3	P2	W		
4	U	P2	0.3 ~ 0.7 V	—
5	V	P2		
6	W	P2		
7	N3	U		
8	N3	V		
9	N3	W	1.2 V and over	Due to condenser charge and so on, resistance measurement may require some time.
10	U	N3		
11	V	N3		
12	W	N3		

6.5 Refrigerant Overcharge Check

CHECK 6

The only way to judge as the overcharge of refrigerant is with operating conditions due to the relationship to pressure control and electronic expansion valve control.
As information for making a judgment, refer to the information below.

Diagnosis of overcharge of refrigerant

1. High pressure rises. Consequently, overload control is conducted to cause insufficient cooling capacity.
2. The superheating degree of suction gas lowers (or the wet operation is performed). Consequently, the compressor becomes lower in discharge pipe temperature despite of pressure loads.
3. The subcooling degree of condensate rises. Consequently, in heating, the temperature of discharge air through the subcooled section becomes lower

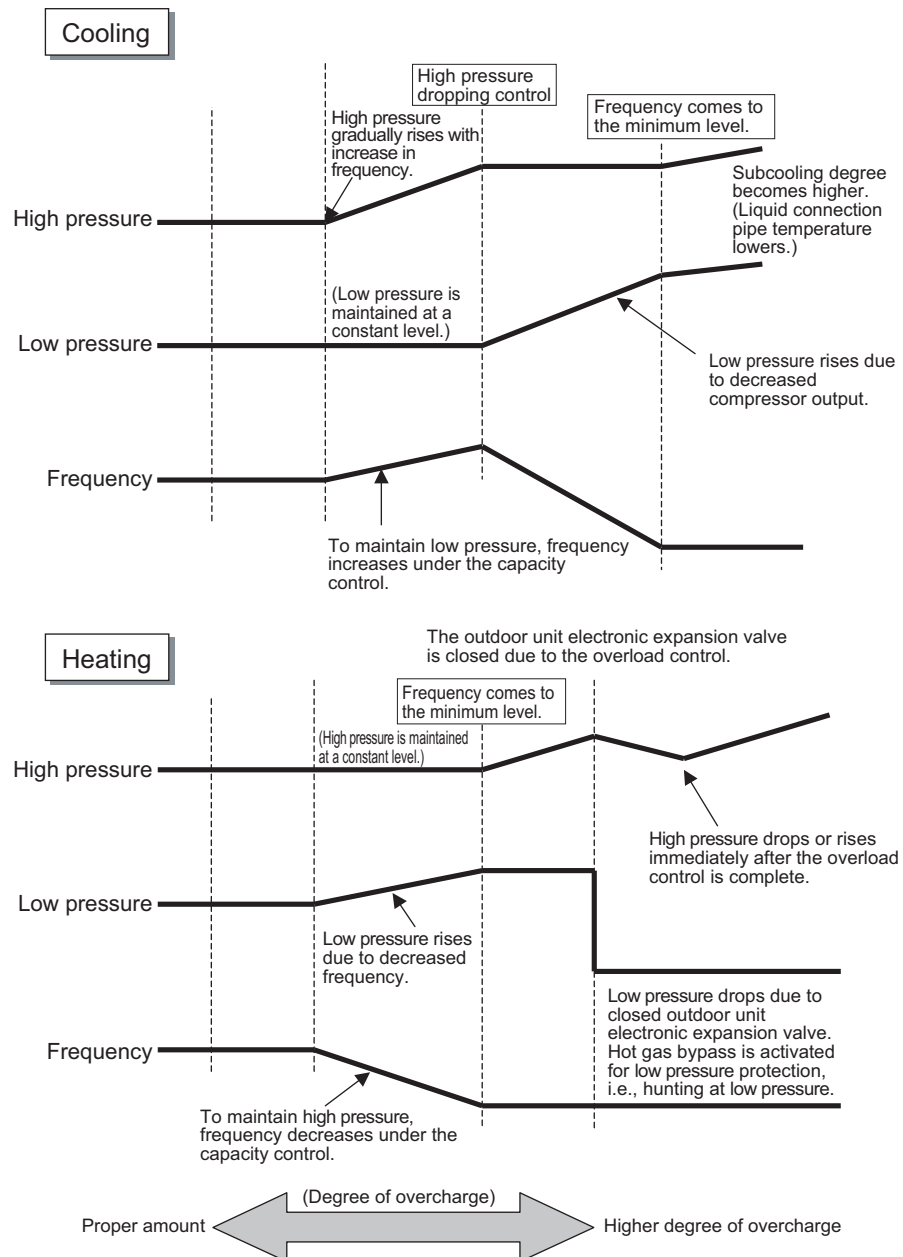

6.6 Refrigerant Shortage Check

CHECK 7

The only way to judge as the shortage of refrigerant is with operating conditions due to the relationship to pressure control and electronic expansion valve control. As information for making a judgment, refer to the information below.

Diagnosis of shortage of refrigerant

1. The superheating degree of suction gas rises. Consequently, the compressor discharge gas temperature becomes higher.
2. The superheating degree of suction gas rises. Consequently, the electronic expansion valve turns open.
3. Low pressure drops to cause the unit not to demonstrate cooling capacity (heating capacity).

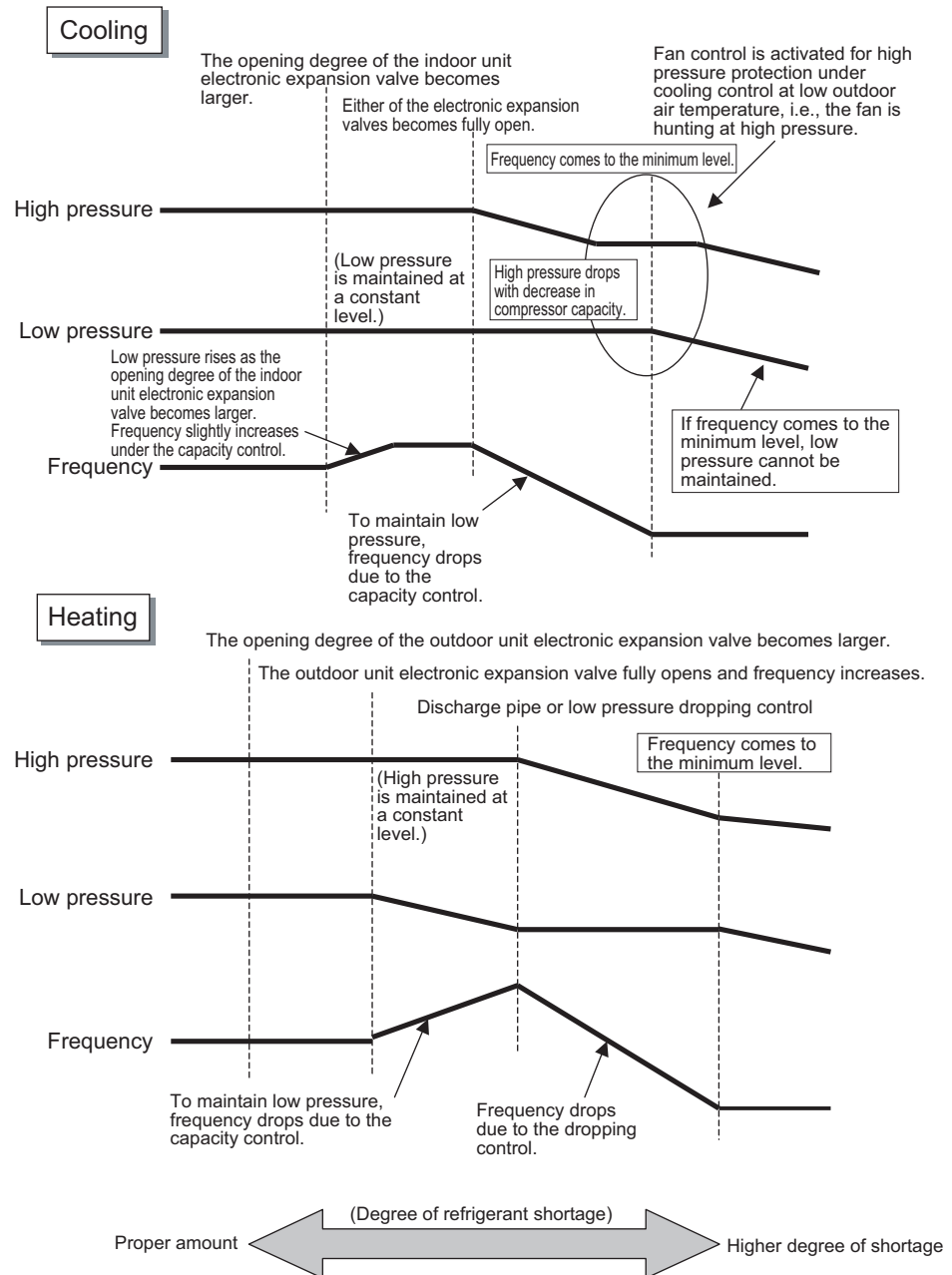

6.7 Vacuuming and Dehydration Procedure

CHECK 8

Conduct vacuuming and dehydration in the piping system following the procedure for Normal vacuuming and dehydration described below.

Furthermore, if moisture may get mixed in the piping system, follow the procedure for Special vacuuming and dehydration described below.

Normal vacuuming and dehydration

1. Vacuuming and dehydration
 - Use a vacuum pump that enables vacuuming up to 500 microns.
 - Connect manifold gauges to the service ports of liquid pipe and gas pipe and run the vacuum pump for a period of 2 or more hours to conduct evacuation to 500 microns.
 - If the degree of vacuum does not reach 500 microns or less even though evacuation is conducted for a period of 2 hours, moisture will have entered the system or refrigerant leakage will have been caused. In this case, conduct evacuation for a period of another 1 hour.
 - If the degree of vacuum does not reach 500 microns or less even though evacuation is conducted for a period of 3 hours, conduct the leak tests.
2. Leaving in vacuum state
 - Leave the compressor at the degree of vacuum of 500 microns or less for a period of 1 hour or more, and then check to be sure that the vacuum gauge reading does not rise. (If the reading rises, moisture may have remained in the system or refrigerant leakage may have been caused.)
3. Additional refrigerant charge
 - Purge air from the manifold gauge connection hoses, and then charge a necessary amount of refrigerant.

Special vacuuming and dehydration

Use this procedure if moisture may get into the piping, such as construction during the rainy season (dew condensation may occur, or rainwater may enter the piping during construction work).

1. Vacuuming and dehydration
 - Follow the same procedure as that for normal vacuuming and dehydration described above.
2. Vacuum break
 - Pressurize with nitrogen gas up to 375,000 microns.
3. Vacuuming and dehydration
 - Conduct vacuuming and dehydration for a period of 1 hour or more. If the degree of vacuum does not reach 500 microns or less even though evacuation is conducted for a period of 2 hours or more, repeat vacuum break - vacuuming and dehydration.
4. Leaving in vacuum state
 - Leave the compressor at the degree of vacuum of 500 microns or less for a period of 1 hour or more, and then check to be sure that the vacuum gauge reading does not rise.
5. Additional refrigerant charge
 - Purge air from the manifold gauge connection hoses, and then charge a necessary amount of refrigerant.

6.8 List of Inverter-Related Error Codes

CHECK 9

	Code	Name	Condition for determining error	Major cause
Compressor current	L5	Instantaneous overcurrent of compressor	<ul style="list-style-type: none"> Inverter output current exceeds 59.1 A even instantaneously. 	<ul style="list-style-type: none"> Liquid sealing Defective compressor Defective inverter PCB
	L8	Overcurrent of compressor (Electronic superheating protection sensor)	<ul style="list-style-type: none"> Compressor overload running A current of 33.5 A or more continues for a period of consecutive 5 seconds or that of 27.6 A or more continues for a period of consecutive 260 seconds. The inverter loses synchronization. 	<ul style="list-style-type: none"> Back-flow of compressor liquid Sudden changes in loads Disconnected compressor wiring Defective PCB
Protection device and others	E5	Compressor lock	<ul style="list-style-type: none"> The compressor is in the locked status (does not rotate). 	<ul style="list-style-type: none"> Defective compressor
	L1	Defective inverter PCB	<ul style="list-style-type: none"> No output is given. 	<ul style="list-style-type: none"> Defective heavy current part of compressor
	L4	Radiation fin temperature rise	<ul style="list-style-type: none"> The radiation fin temperature reaches 87°C (188°F) or more (while in operation). 	<ul style="list-style-type: none"> Defective fan Running in overload for an extended period of time Defective PCB
	L9	Defective startup of inverter compressor	<ul style="list-style-type: none"> The compressor motor fails to start up. 	<ul style="list-style-type: none"> Liquid sealing or defective compressor Excessive oil or refrigerant Defective PCB
	LC	Transmission error between microcomputers on the outdoor unit main PCB	<ul style="list-style-type: none"> No communications are carried out across the microcomputers on the outdoor unit main PCB. 	<ul style="list-style-type: none"> Defective outdoor unit main PCB
	P1	Imbalanced power supply	<ul style="list-style-type: none"> Power supply voltages get significantly imbalanced among three phases. 	<ul style="list-style-type: none"> Power supply error (imbalanced voltages of 2% or more) Defective PCB Dead PCB
	P4	Defective radiation fin thermistor	<ul style="list-style-type: none"> The radiation fin thermistor gets short circuited or open. 	<ul style="list-style-type: none"> Defective radiation fin thermistor
	U2	Power supply voltage error	<ul style="list-style-type: none"> The inverter power supply voltage is high or low. 	<ul style="list-style-type: none"> Power supply error Defective PCB

6.9 Concept of Inverter-Related Error Codes

CHECK 10

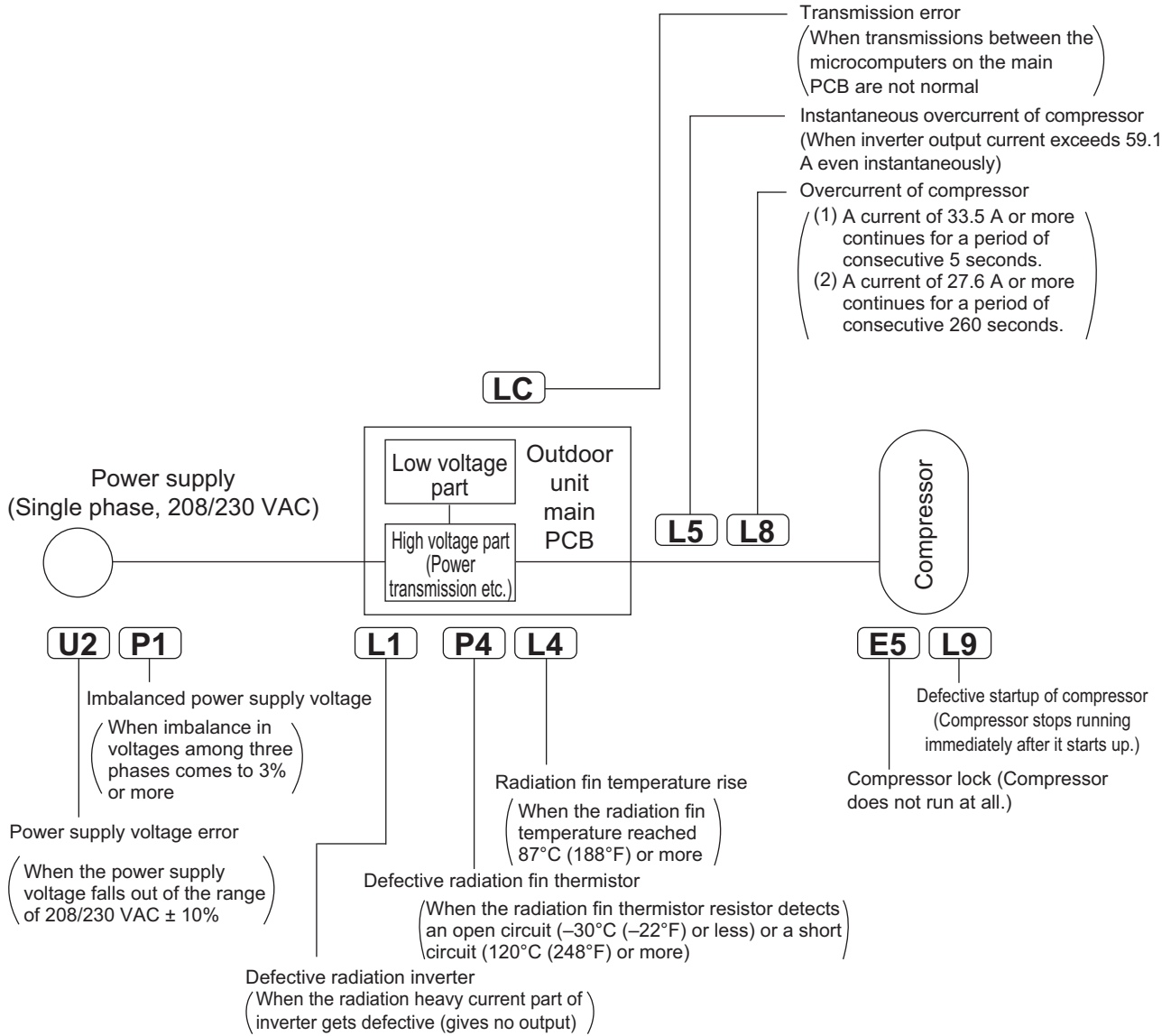

6.10 Thermistor Check

CHECK 11 Thermistor type of indoor units

Model	Suction air thermistor	Indoor heat exchanger (liquid) thermistor	Indoor heat exchanger (gas) thermistor	Discharge air thermistor
	R1T	R2T	R3T	R4T
FCQ-TA	Type C	Type A	Type J	—
FCQ-AA			Type A	—
FHQ-P	Type B		Type J	—
FHQ-M				—
FAQ-TA				—
FBQ-P			Type J	
FBQ-TB			—	
FTQ-TA	—		Type A	—

Thermistor type of outdoor units

Electric symbol	Thermistor	Type	
		18/24 class	30-48 class
R1T	Outdoor air	E	E
R2T	Discharge pipe	G	G
R3T	Suction pipe 1	A	A
R4T	Heat exchanger deicer	A	A
R5T	Suction pipe 2	A	A
R6T	Subcooling heat exchanger gas pipe	—	A
R7T	Liquid pipe	A	A
R10T/FINTH	Radiation fin	K	K

Thermistor temperature		Resistance (k Ω)			
(°C)	(°F)	Type A	Type B	Type C	Type E
-30	-22	363.8	—	—	357.9
-25	-13	266.8	—	—	263.5
-20	-4	197.8	—	—	196.1
-15	5	148.2	—	—	147.4
-10	14	112.0	111.1	111.8	111.8
-5	23	85.52	84.95	85.42	85.53
0	32	65.84	65.53	65.80	66.00
5	41	51.05	50.95	51.07	51.31
10	50	39.91	39.92	39.97	40.20
15	59	31.44	31.50	31.51	31.74
20	68	24.95	25.02	25.02	25.23
25	77	19.94	20.00	20.00	20.19
30	86	16.04	16.10	16.10	16.26
35	95	12.99	13.04	13.04	13.17
40	104	10.58	10.63	10.63	10.74
45	113	8.669	8.720	8.711	8.806
50	122	7.143	7.189	7.179	7.260
55	131	5.918	—	—	6.014
60	140	4.928	—	—	5.008
65	149	4.123	—	—	4.191
70	158	3.467	—	—	3.525
75	167	—	—	—	2.978
80	176	—	—	—	2.527
85	185	—	—	—	2.153
90	194	—	—	—	1.843
95	203	—	—	—	1.583
100	212	1.339	—	—	1.365
105	221	—	—	—	1.181
Drawing No.		3SA48002 3SA48004 3SA48018 3SA48019 (AD94A045) 3SA48013 (AD100026)	3SA48001 (AD210486)	3SA48016 (AD100008) 3SA480014 (AD150384)	3SA480025 (AD180054)

*The data is for reference purpose only.

Thermistor temperature		Resistance (k Ω)		
(°C)	(°F)	Type G	Type J	Type K
-30	-22	4759	352.1	350.6
-25	-13	3454	261.2	257.4
-20	-4	2534	195.4	191.0
-15	5	1877	147.3	143.2
-10	14	1404	111.8	108.4
-5	23	1059	85.49	82.83
0	32	806.5	65.80	63.80
5	41	618.9	51.15	49.53
10	50	478.8	40.08	38.75
15	59	373.1	31.64	30.56
20	68	292.9	25.16	24.26
25	77	231.4	20.14	19.40
30	86	184.1	16.23	15.62
35	95	147.4	13.16	12.65
40	104	118.7	10.73	10.31
45	113	96.13	8.800	8.447
50	122	78.29	7.255	6.962
55	131	64.10	6.012	5.769
60	140	52.76	5.010	4.805
65	149	43.63	4.196	4.021
70	158	36.26	3.532	3.381
75	167	30.27	2.987	2.856
80	176	25.38	2.538	2.422
85	185	21.37	2.166	2.063
90	194	18.06	1.857	1.764
95	203	15.33	1.598	1.515
100	212	13.06	1.380	1.305
105	221	11.17	1.196	1.128
110	230	9.585	1.041	0.9781
115	239	8.254	0.908	0.8506
120	248	7.131	0.795	0.7420
125	257	6.181	0.698	0.6495
130	266	5.374	0.615	0.5700
135	275	4.686	0.543	—
140	284	4.098	0.481	—
145	293	3.594	0.428	—
150	302	3.161	0.381	—
Drawing No.		3SA48009 (AD970175)	3SA48005 (AD190114)	3P204139 (AD070077)

*The data is for reference purpose only.

6.11 Pressure Sensor Check

CHECK 12

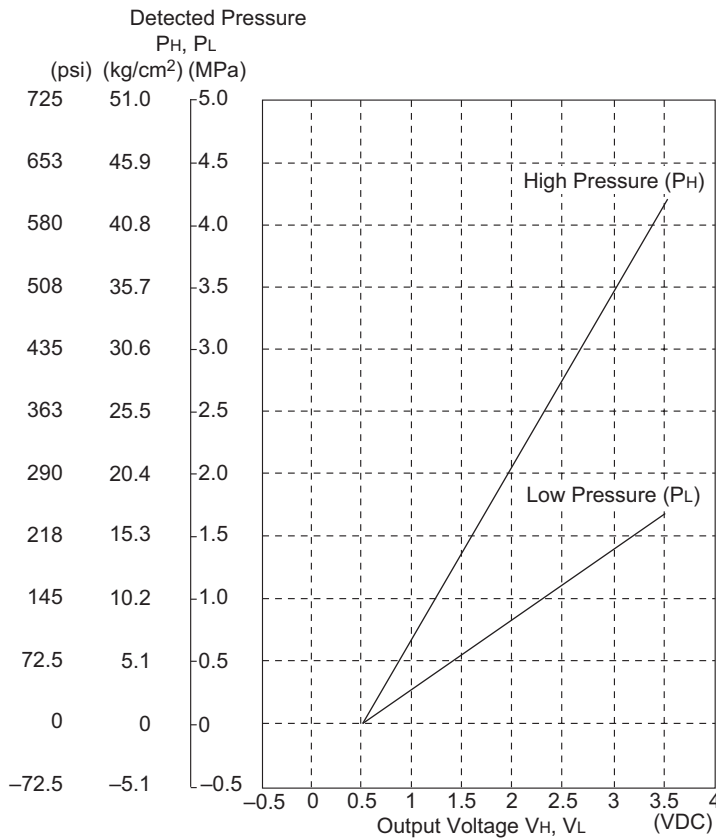

$$P_H \text{ (MPa)} = \frac{4.15}{3.0} \times V_H - \frac{4.15}{3.0} \times 0.5$$

$$P_L \text{ (MPa)} = \frac{1.7}{3.0} \times V_L - \frac{1.7}{3.0} \times 0.5$$

1 MPa = 145 psi

PH : High pressure (MPa)

PL : Low pressure (MPa)

VH : Output Voltage (High Side) (VDC)

VL : Output Voltage (Low Side) (VDC)

Voltage Measurement Point of the High Pressure Sensor

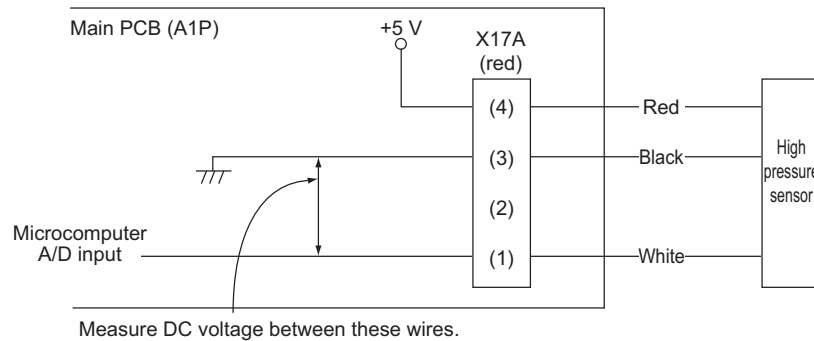

Voltage Measurement Point of the Low Pressure Sensor

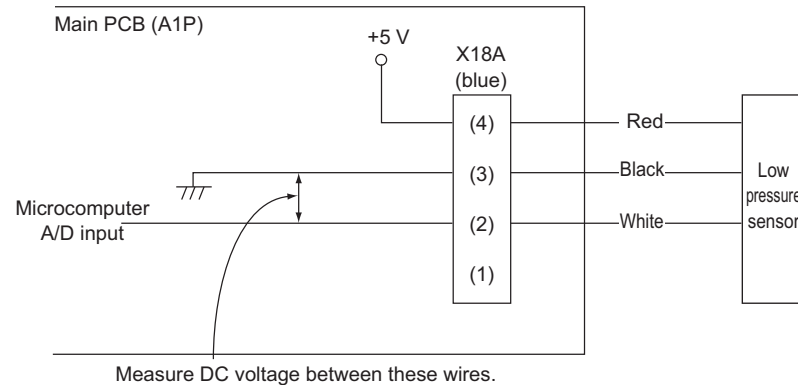

6.12 Broken Wire Check of the Relay Wires

CHECK 15

Procedure for checking indoor-outdoor unit transmission wiring for broken wires (for checking the indoor-outdoor unit transmission wiring of the outdoor unit for broken wires).

Turn OFF the power supply to all equipment, short circuit between the indoor-outdoor unit terminal F1 and F2 in the outdoor unit, and then conduct continuity checks between the transmission wirings F1 and F2 of the "Indoor Unit a" that is farthest from the outdoor unit using a multimeter. If there is continuity between the said transmission wirings, the indoor-outdoor unit transmission wiring has no broken wires in it.

If there is no continuity, the transmission wiring may have broken wires. With the indoor-outdoor unit terminal of the outdoor unit short circuited, identify the place with continuity in the transmission wiring of the "Indoor Unit b", transmission wiring of the "Indoor Unit c", and transmission wiring of the "Indoor Unit d" in the order described.

If the place with continuity can be identified, there may be broken wires in places before the said place with continuity.

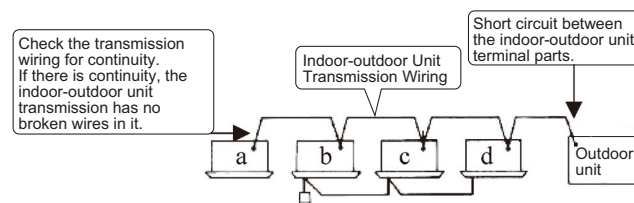

6.13 Fan Motor Connector Check

CHECK 16

Resistance measuring points and judgment criteria.

Indoor Unit

FCQ-TA, FAQ-TA, FBQ18/24TB

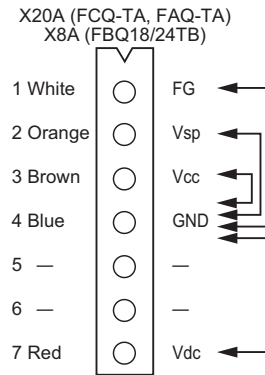

Measuring points	Judgment criteria
1 - 4	1 Ω or more
2 - 4	
3 - 4	
7 - 4	

FCQ-AA

1. Turn the power supply OFF.
2. Disconnect the fan motor connector from the PCB and measure the resistances between U-V, V-W and W-U.

Judgment: Resistances must be balanced within 20%.

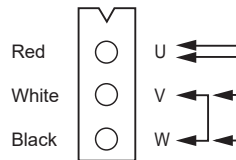

FHQ-P, FHQ-M

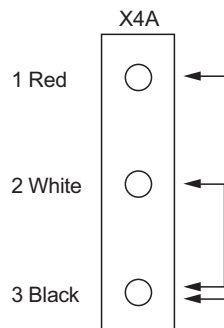

Measuring points	Judgment criteria
1 - 3	53.5 Ω ± 10%
2 - 3	31.6 Ω ± 10%

FBQ-P, FBQ30-48TB

- (1) Measurement of power wire connector.
Remove the X1A connector from the fan PCB (A2P) and measure the resistance between the U and V, V and W, and W and U phases of the motor connector (with five conductors) and check that each phase are balanced (within a permissible dispersion range of $\pm 20\%$).
- (2) Measurement of signal wire connector.
Remove the X2A connector and measure the resistance between GND and Vcc, Hw, Hv, or Hu terminals of the motor connector (with five conductors).

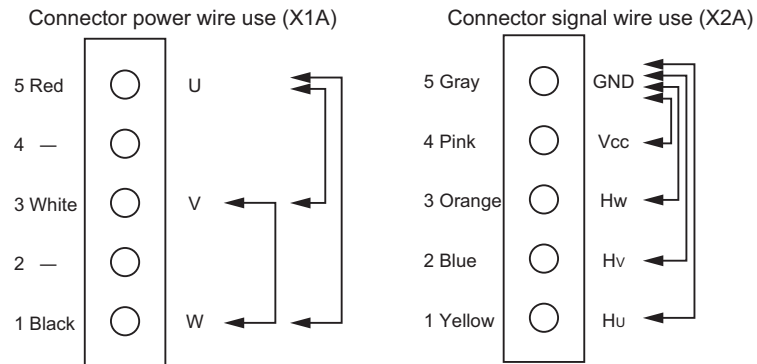

Outdoor Unit

- (1) Turn OFF the power supply.
- (2) Remove the connector (X106A, X107A) on the PCB to measure the resistance value.
Judgment criteria: resistance value between each phase is within $\pm 20\%$

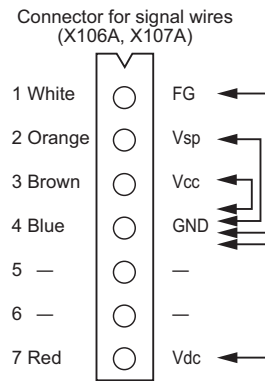

6.14 Electronic Expansion Valve Coil Check

CHECK 18

Measure the connector pin-to-pin resistance and make sure that the resistance value is within the range listed in the table below.

Indoor Unit

FCQ-TA, FCQ-AA, FBQ-TB, FTQ-TA

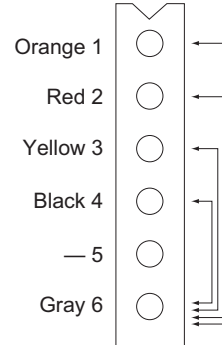

Measuring points	Judgment criteria
1 - 6	35-55 Ω
2 - 6	
3 - 6	
4 - 6	

FBQ-P, FAQ-TA

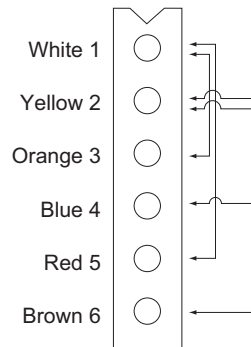

Measuring points	Judgment criteria
1 - 3	300 Ω
1 - 5	150 Ω
2 - 4	300 Ω
2 - 6	150 Ω

FHQ-P, FHQ-M

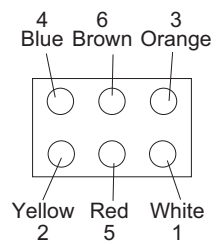

Measuring points	Judgment criteria
1 - 3	300 Ω
1 - 5	150 Ω
2 - 4	300 Ω
2 - 6	150 Ω

Outdoor Unit

18/24 class



Measuring points	Judgment criteria
1 - 6	35-55 Ω
2 - 6	
3 - 6	
4 - 6	

30-48 class

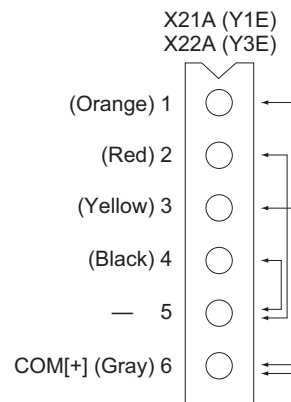

Measuring points	Judgment criteria
1 - 6	35-55 Ω
2 - 6	
3 - 6	
4 - 6	

6.15 Fan Motor Connector Check for FTQ-TA

CHECK 19

CHECKING EMERSON ULTRATECH™ ECM MOTORS

The FTQ-TA models utilize an Emerson, 4-wire variable speed ECM blower motor. The ECM blower motor provides constant CFM.

The motor is a serially communicating variable speed motor. Only four wires are required to control the motor: +Vdc, Common, Receive, and Transmit.

The +Vdc and Common wires provide power to the motor's low voltage control circuits.

General Checks / Considerations

1. Check power supply to the air handler or modular blower. Ensure power supply is within the range specified on rating plate.
2. Check motor power harness. Ensure wires are continuous and make good contact when seated in the connectors. Repair or replace as needed.
3. Check motor control harness. Ensure wires are continuous and make good contact when seated in the connectors. Repair or replace as needed.
4. Check blower wheel. Confirm wheel is properly seated on motor shaft. Set screw must be on shaft flat and torqued to 165 in-lbs minimum. Confirm wheel has no broken or loose blades. Repair or replace as needed.
5. Ensure motor and wheel turn freely. Check for interference between wheel and housing or wheel and motor. Repair or replace as needed.
6. Check housing for cracks and/or corrosion. Repair or replace as needed.
7. Check motor mounting bracket. Ensure mounting bracket is tightly secured to the housing. Ensure bracket is not cracked or broken.

Emerson UltraCheck-EZ™ Diagnostic Tool

The Emerson UltraCheck-EZ™ diagnostic tool may be used to diagnose the ECM motor.



Warning

HIGH VOLTAGE!

Disconnect ALL power before servicing or installing. Multiple power sources may be present. Failure to do so may cause property damage, personal injury or death.

To use the diagnostic tool, perform the following steps:

1. Disconnect power to the air handler.
2. Disconnect the 4-circuit control harness from the motor.
3. Plug the 4-circuit connector from the diagnostic tool into the motor control connector.
4. Connect one alligator clip from the diagnostic tool to a ground source.
5. Connect the other alligator clip to a 24VAC source.

NOTE: The alligator clips are NOT polarized.

NOTE: The UltraCheck-EZ™ diagnostic tool is equipped with a nonreplaceable fuse.

Connecting the tool to a source other than 24VAC could damage the tool and cause the fuse to open. Doing so will render the diagnostic tool inoperable.

6. Turn on power to air handler or modular blower.



Warning

Line Voltage now present.

7. Depress the orange power button on the diagnostic tool to send a run signal to the motor. Allow up to 5 seconds for the motor to start.

NOTE: If the orange power button does not illuminate when depressed, the tool either has an open fuse or is not properly connected to a 24VAC source.

8. The green LED on the diagnostic tool will blink indicating communications between the tool and motor. See table below for indications of tool indicators and motor actions. Replace or repair as needed.

Power Button	Green LED	Motor Action	Indication(s)
OFF	OFF	Not Rotating	Confirm 24VAC to UltraCheck-EZ™ tool. If 24VAC is confirmed, diagnostic tool is inoperable.
ON	Blinking	Rotating	Motor and control/end bell are functioning properly.
ON	OFF	Rotating	Replace motor control/end bell.
ON	Blinking	Not Rotating	Check motor (refer to Motor Checks on page 361).
ON	OFF	Not Rotating	Replace motor control/end bell; verify motor (refer to Motor Checks on page 361).

9. Depress the orange power button to turn off motor.

10. Disconnect power. Disconnect diagnostic tool.

11. Reconnect the 4-wire harness from control board to motor.

Electrical Checks - High Voltage Power Circuits



Warning

HIGH VOLTAGE!

Disconnect ALL power before servicing or installing. Multiple power sources may be present. Failure to do so may cause property damage, personal injury or death.

1. Disconnect power to air handler or modular blower.
2. Disconnect the 5-circuit power connector to the ECM motor.
3. Turn on power to air handler or modular.



Warning

Line Voltage now present.

4. Measure voltage between pins 4 and 5 on the 5-circuit connector. Measured voltage should be the same as the supply voltage to the air handler or modular.

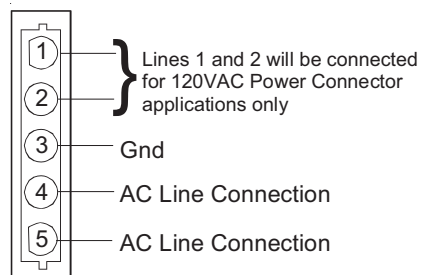

5. Measure voltage between pins 4 and 3. Voltage should be approximately half of the voltage measured in step 4.
6. Measure voltage between pins 5 and 3. Voltage should be approximately half of the voltage measured in step 4.
7. If no voltage is present, check supply voltage to air handler or modular blower.
8. Disconnect power to air handler or modular blower. Reconnect the 5-circuit power harness disconnected in step 2.

Electrical Checks - Low Voltage Control Circuits

1. Turn on power to air handler or modular.



Warning

Line Voltage now present.

2. Check voltage between pins on the 4-wire motor control harness between the motor and control board.

3. Voltage on pins should read:

Pins 1 to 4 = 3.3vdc

Pins 1 to 2 = 3.3vdc

Pins 3 to 4 = 15vdc

Motor Control/End Bell Checks



Warning

HIGH VOLTAGE!

Disconnect ALL power before servicing or installing. Multiple power sources may be present. Failure to do so may cause property damage, personal injury or death.

1. Disconnect power to air handler or modular blower.

NOTE: Motor contains capacitors that can hold a charge for several minutes after disconnecting power. Wait 5 minutes after removing power to allow capacitors to discharge.

2. Disconnect the motor control harness and motor power harness.
3. Remove the blower assembly from the air handler or modular blower.
4. Remove the (3) screws securing the control/end bell to the motor. Separate the control/end bell. Disconnect the 3-circuit harness from the control/end bell to remove the control/end bell from the motor.
5. Inspect the NTC thermistor inside the control/end bell. Replace control/end bell if thermistor is cracked or broken.

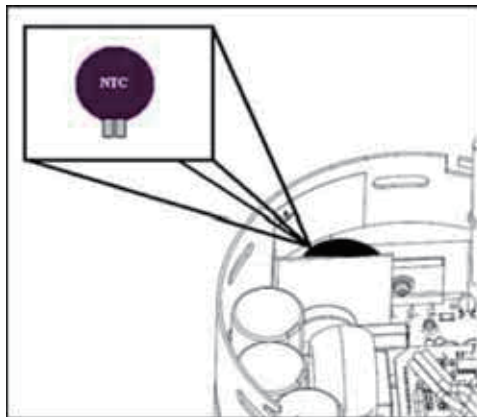

6. Inspect the large capacitors inside the control/end bell. Replace the control/end bell if any of the capacitors are bulging or swollen.

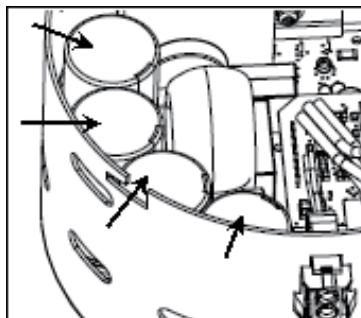

7. Locate the 3-circuit connector in the control/end bell. Using an ohmmeter, check the resistance between each terminal in the connector. If the resistance is $1\text{ M}\Omega$ or greater, the control/end bell is functioning properly. Replace the control/end bell if the resistance is lower than $1\text{ M}\Omega$.
8. Reassemble motor and control/end bell in reverse of disassembly. Replace blower assembly into air handler or modular blower.

Motor Checks



Warning

HIGH VOLTAGE!

Disconnect ALL power before servicing or installing. Multiple power sources may be present. Failure to do so may cause property damage, personal injury or death.

1. Disconnect power to air handler or modular blower.
NOTE: Motor contains capacitors that can hold a charge for several minutes after disconnecting power. Wait 5 minutes after removing power to allow capacitors to discharge.
2. Disassemble motor as described in steps 2 through 4 above.
3. Locate the 3-circuit harness from the motor. Using an ohmmeter, measure the resistance between each motor phase winding. The resistance levels should be equal. Replace the motor if the resistance levels are unequal, open circuited or short circuited.
4. Measure the resistance between each motor phase winding and the motor shell. Replace the motor if any phase winding is short circuited to the motor shell.
5. Reassemble motor and control/end bell in reverse of disassembly. Replace blower assembly into air handler or modular blower.

Part 7 Appendix

1. Wiring Diagrams.....	363
1.1 Outdoor Unit.....	363
1.2 Indoor Unit.....	367

RZR18/24TAVJUA, RZQ18/24TAVJUA, RZR18/24TBVJUA, RZQ18/24TBVJUA

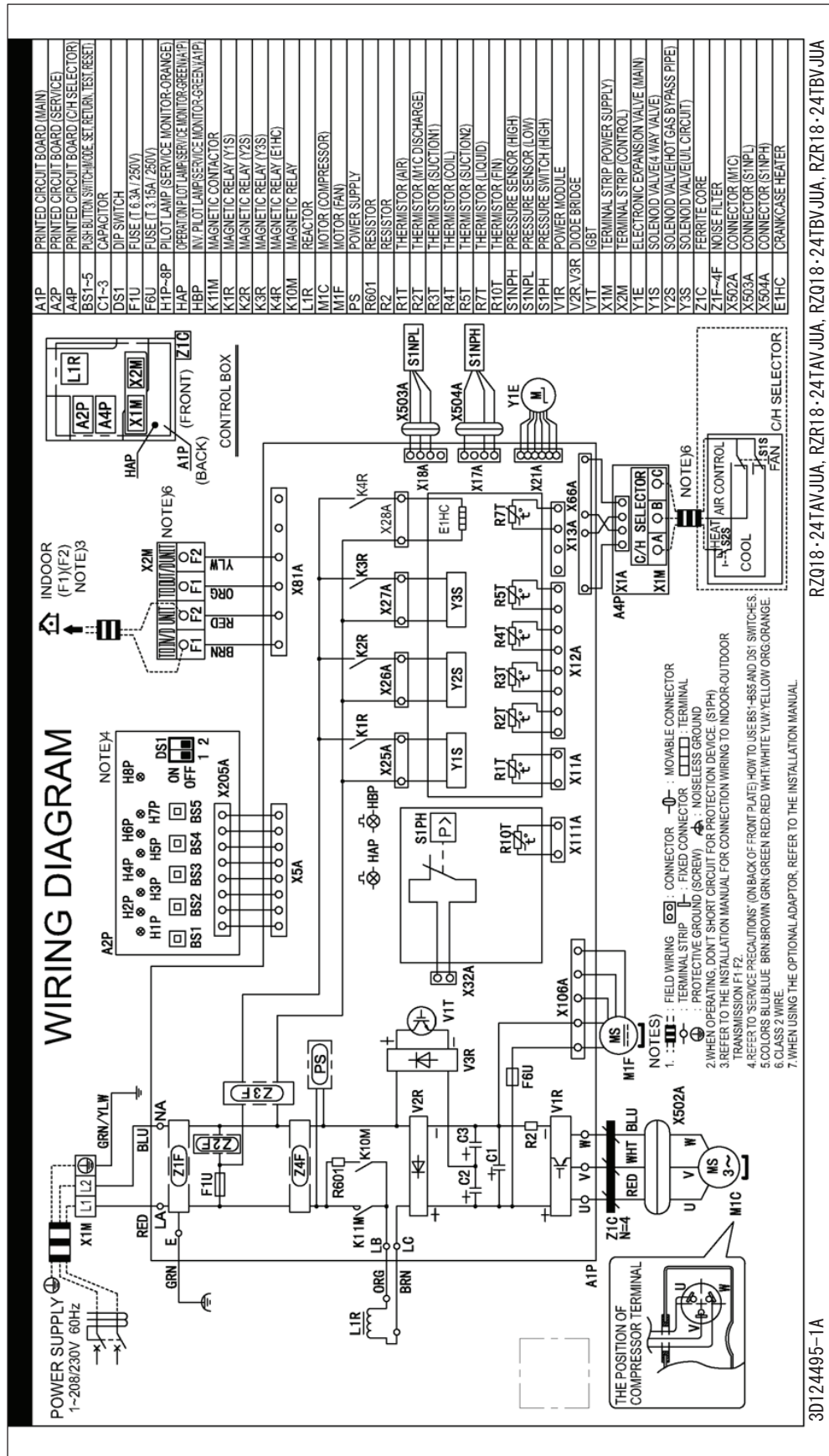

3D124495B

RZR30/36/42/48TAVJU, RZQ30/36/42/48TAVJU

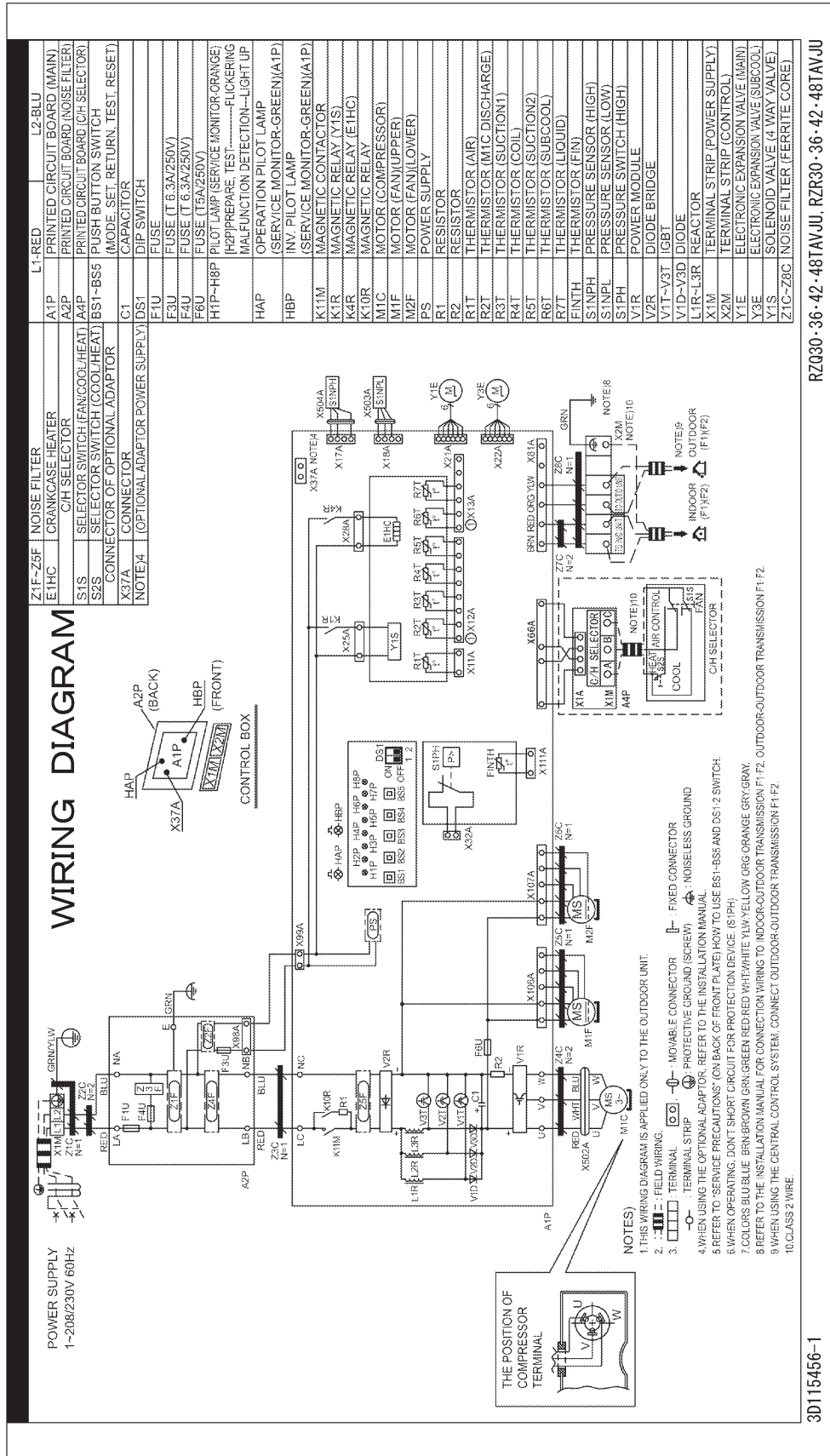

3D115456

3D115456-1

RZR30/36/42/48TAVJUA, RZQ30/36/42/48TAVJUA, RZR30/36/42/48TBVJUA, RZQ30/36/42/48TBVJUA

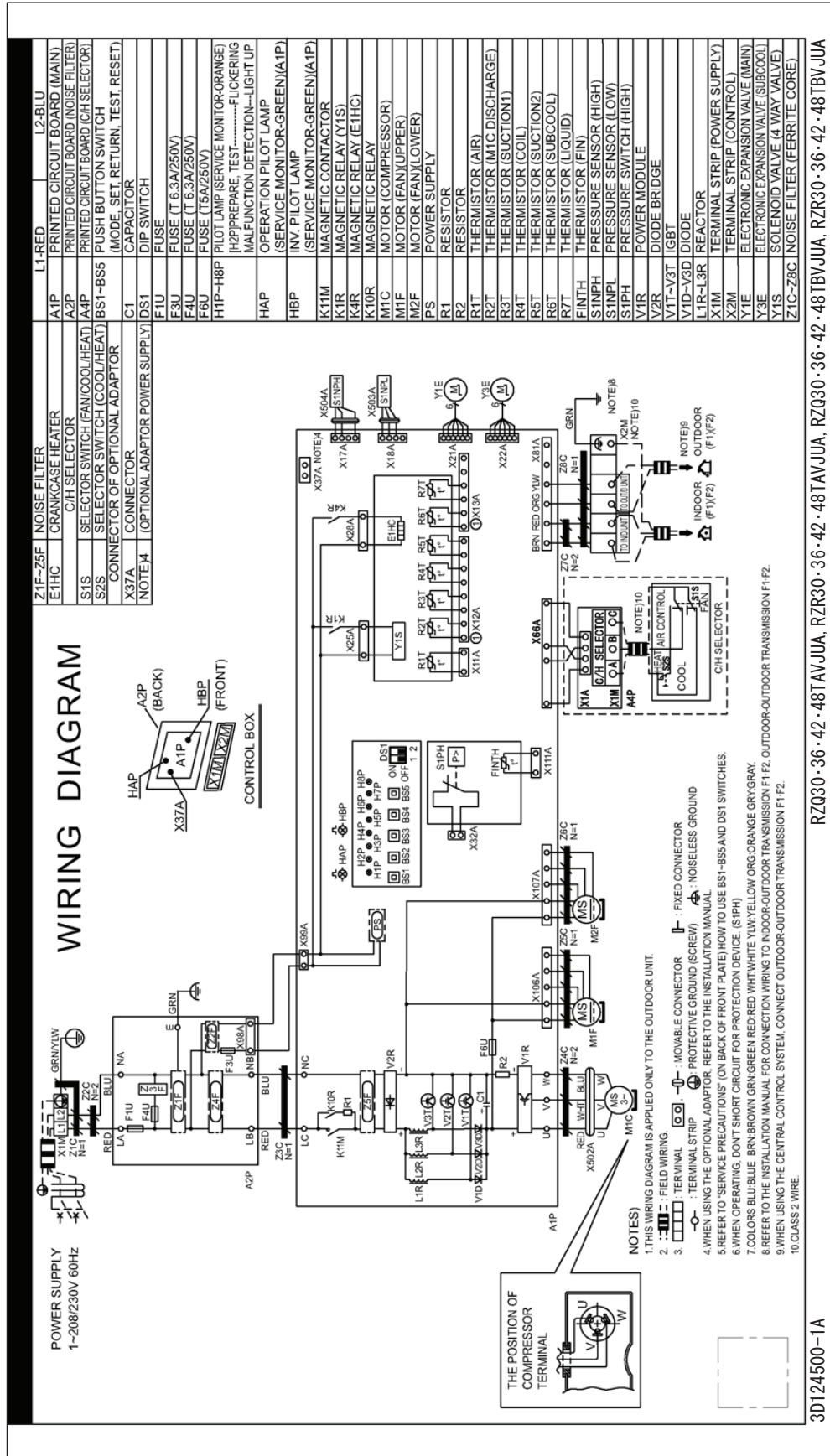

3D124500B

1.2 Indoor Unit

FCQ18/24/30/36/42/48TAVJU

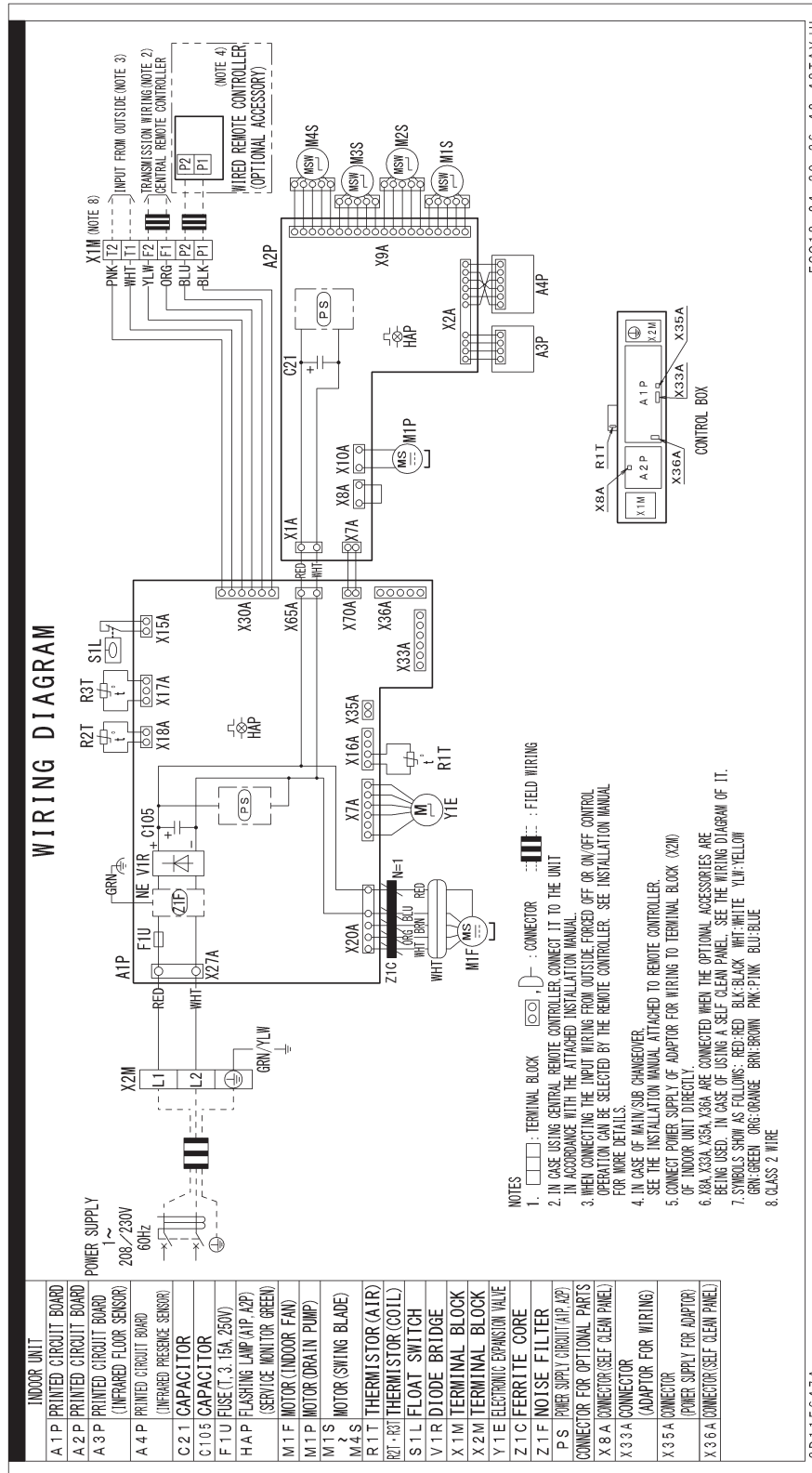

FCQ18-24-30-36-42-48TAVJU

3D115647A

3D115647A

BYCQ125BGW1 (Self-Cleaning Decoration Panel for FCQ-TA)

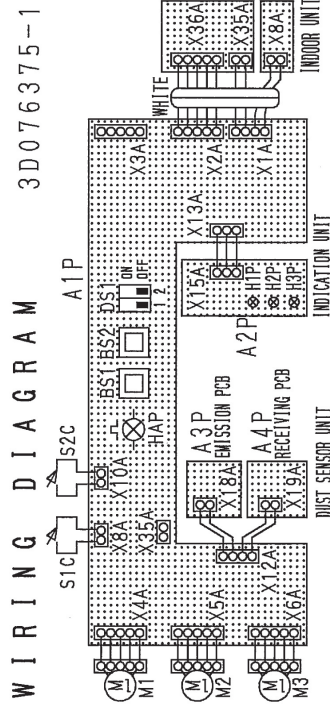

BS1	PUSH BUTTON(FILTER AUTO CLEANING TEST)	HAP LIGHT EMITTING DIODE(SERVICE MONITOR GREEN)
BS2	PUSH BUTTON(RESET OF ABNORMALITY INDICATION)	S1C LIMIT SWITCH(FILTER)
DS1	1 DIP SWITCH(FILTER CLEANING PROHIBITION MODE)	S2C LIMIT SWITCH(DAMPER)
	2 DIP SWITCH(ON: INCREASES LIGHT QUANTITY OF DUST SENSOR)	M1 MOTOR(FILTER)
H1P	INDICATOR AC RUNNING: LIGHTING	M2 MOTOR(BRUSH)
H3P	LAMP(GREEN) FILTER CLEANING RUNNING: FLASHING	M3 MOTOR(DAMPER)
H2P	INDICATOR LAMP(RED) DUST DETECTING: LONG CYCLE FLASHING ABNORMAL: SHORT CYCLE FLASHING	X35A CONNECTER(GROUP CONTROL ADAPTOR)

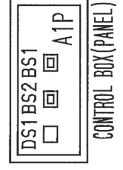

- NOTE) 1. -O- THESE SYMBOLS SHOW CONNECTORS.
 2. WHEN DS1-1, -2 ARE TURNED ON, THEY WILL BE SET TO FILTER CLEANING PROHIBITION MODE AND INCREASE OF DUST DETECTION SENSOR LIGHT QUANTITY.
 3. H1P AND H3P ARE NOT SET TO LIGHT WHEN SHIPPED FROM THE FACTORY.
 4. POWER SUPPLY TO THE ADAPTOR WILL BE CONNECTED TO THE CONNECTOR(X35A) OF A1P.

3D076375A

FCQ18/24/30/36/42/48AAVJU

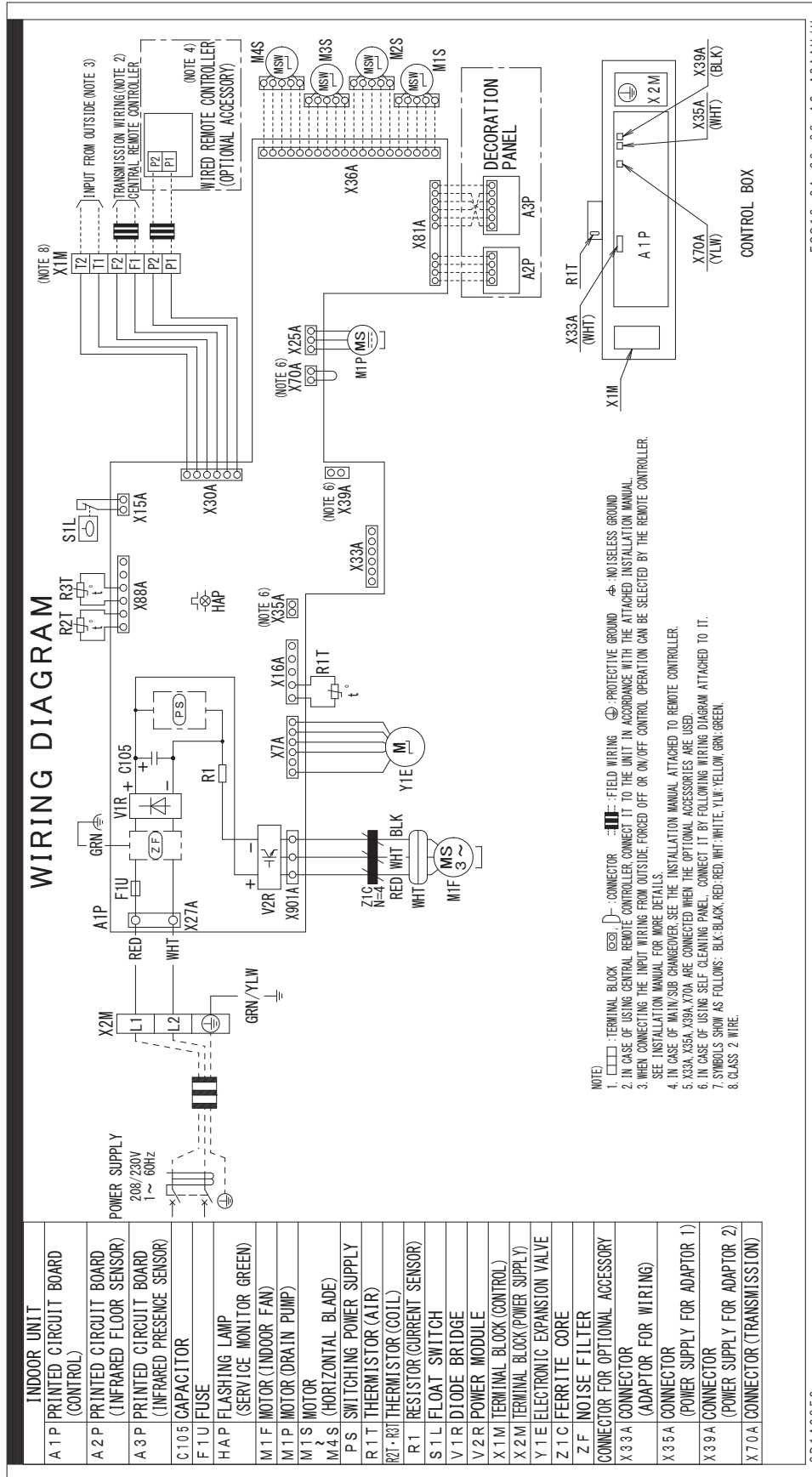

3D142358

BYCQ54EEGFU (Self-Cleaning Decoration Panel for FCQ-AA)

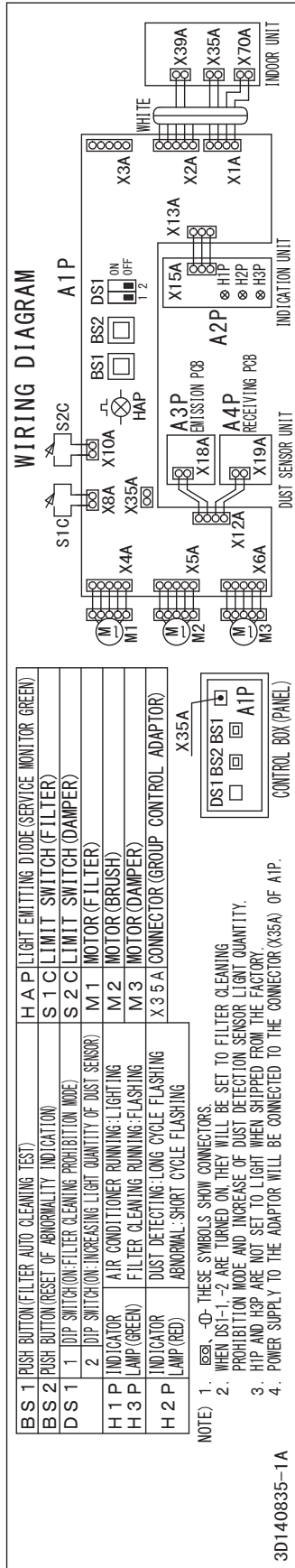

3D140835A

FHQ18/24/30PVJU, FHQ36/42MVJU

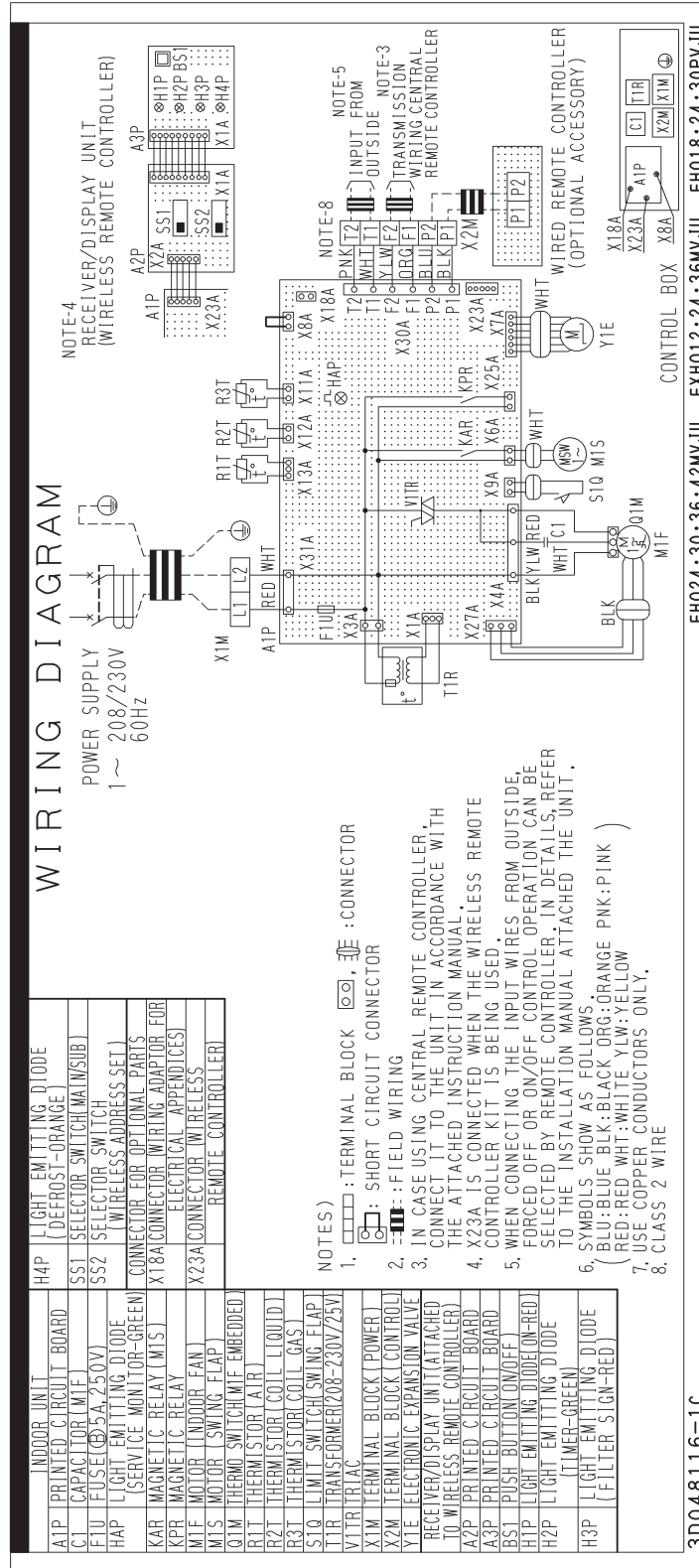

3D048116C

FAQ18/24TAVJU

WIRING DIAGRAM

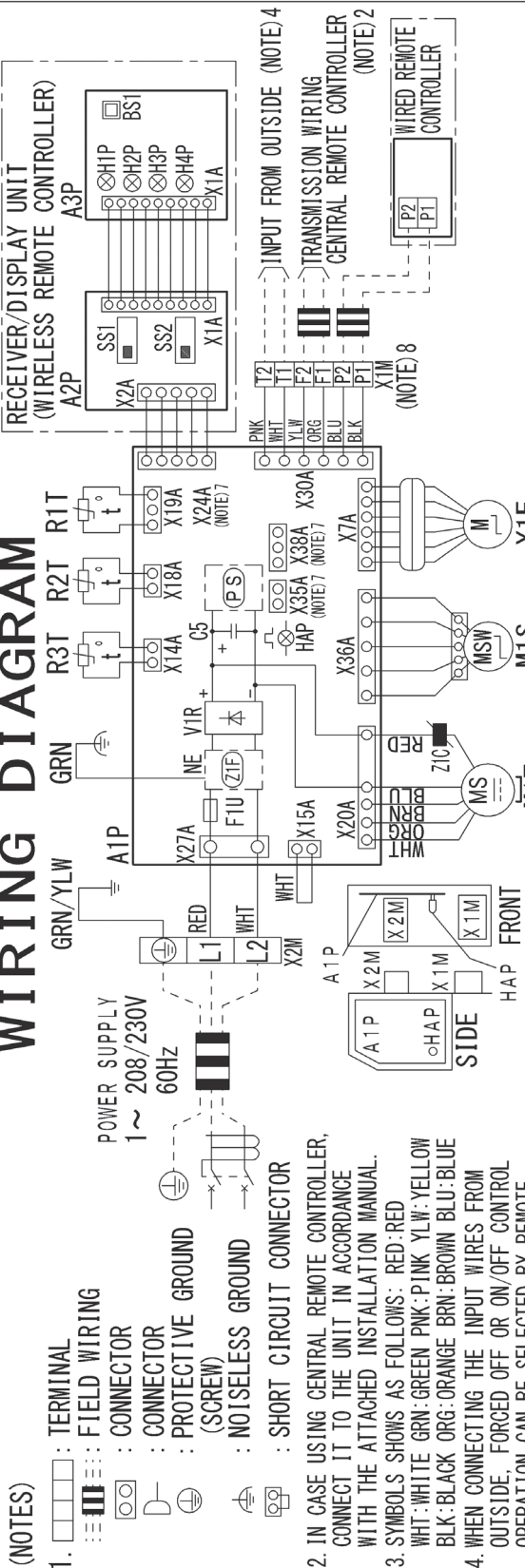

INDOOR UNIT	
A 1 P	PRINTED CIRCUIT BOARD
C 5	CAPACITOR
F 1 U	FUSE (T 3.15AH 250V)
H A P	FLASHING LAMP (SERVICE MONITOR GREEN)
M 1 F	MOTOR (INDOOR FAN)
M 1 S	MOTOR (SWING FLAP)
P S	SWITCHING POWER SUPPLY
R 1 T	THERMISTOR (AIR)
R 2 T	THERMISTOR (COIL LIQUID PIPE)
R 3 T	THERMISTOR (COIL GAS PIPE)
V 1 R	DIODE BRIDGE
X 1 M	TERMINAL BLOCK (CONTROL)
X 2 M	TERMINAL BLOCK (POWER)
Y 1 E	ELECTRONIC EXPANSION VALVE
Z 1 C	FERRITE CORE
Z 1 F	NOISE FILTER
RECEIVER/DISPLAY UNIT (ATTACHED TO WIRELESS REMOTE CONTROLLER)	
A 2 P	PRINTED CIRCUIT BOARD
A 3 P	PRINTED CIRCUIT BOARD
CONTROL BOX	
B S 1	PUSH BUTTON SWITCH (ON/OFF)
H 1 P	PILOT LAMP (ON-RED)
H 2 P	PILOT LAMP (TIMER-GREEN)
H 3 P	PILOT LAMP (FILTER SIGN-RED)
H 4 P	PILOT LAMP (DEFROST-ORANGE)
S S 1	SELECTOR SWITCH (MAIN/SUB)
S S 2	SELECTOR SWITCH (WIRELESS ADDRESS SET)
CONNECTOR FOR OPTIONAL PARTS	
X 1 5 A	CONNECTOR (FLOAT SWITCH)
X 2 4 A	CONNECTOR (WIRELESS REMOTE CONTROLLER)
X 3 5 A	CONNECTOR (GROUP CONTROL ADAPTOR)
X 3 8 A	CONNECTOR (ADAPTOR FOR MULTI TENANT)

FAQ18, 24TAVJU

3D114844B

FBQ18/24/30/36/42/48PVJU

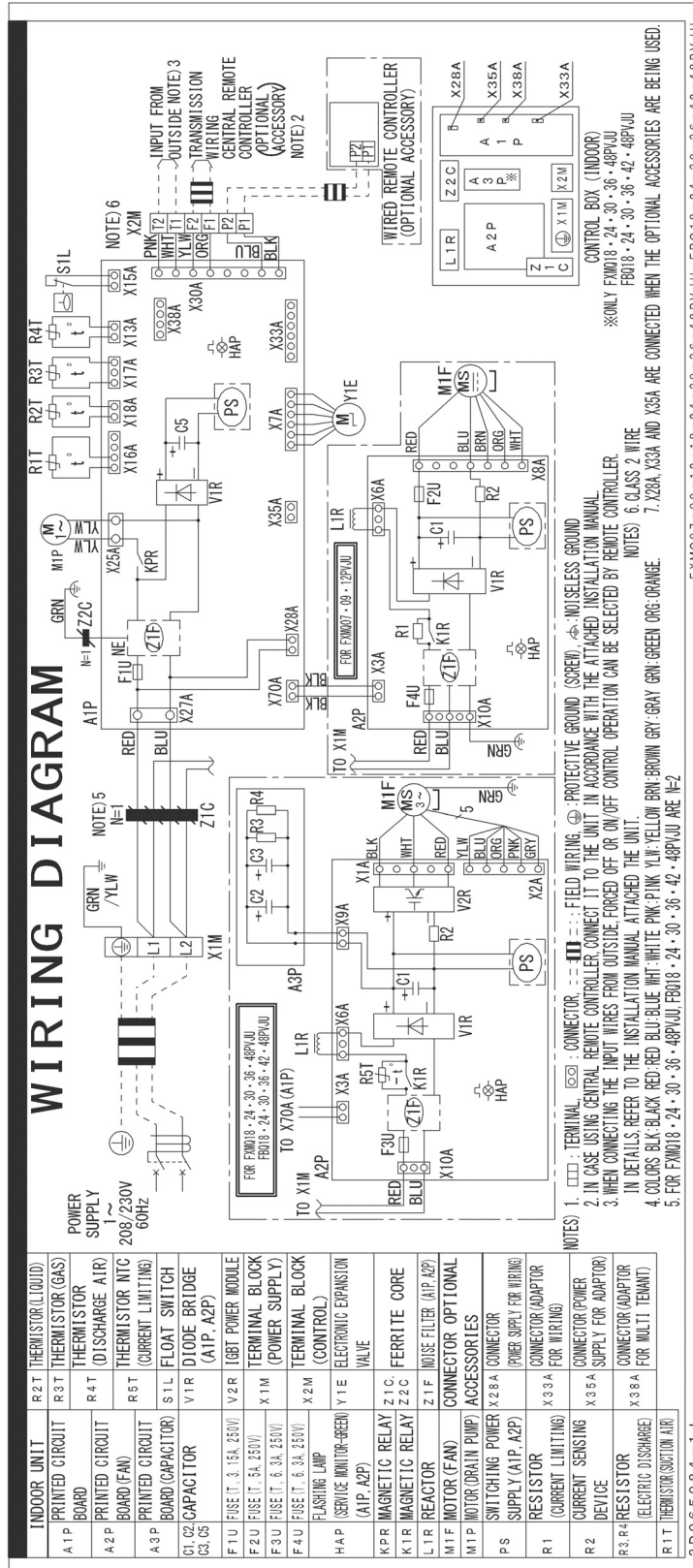

3D065984J

FBQ18/24/30/36/42/48TBVJU

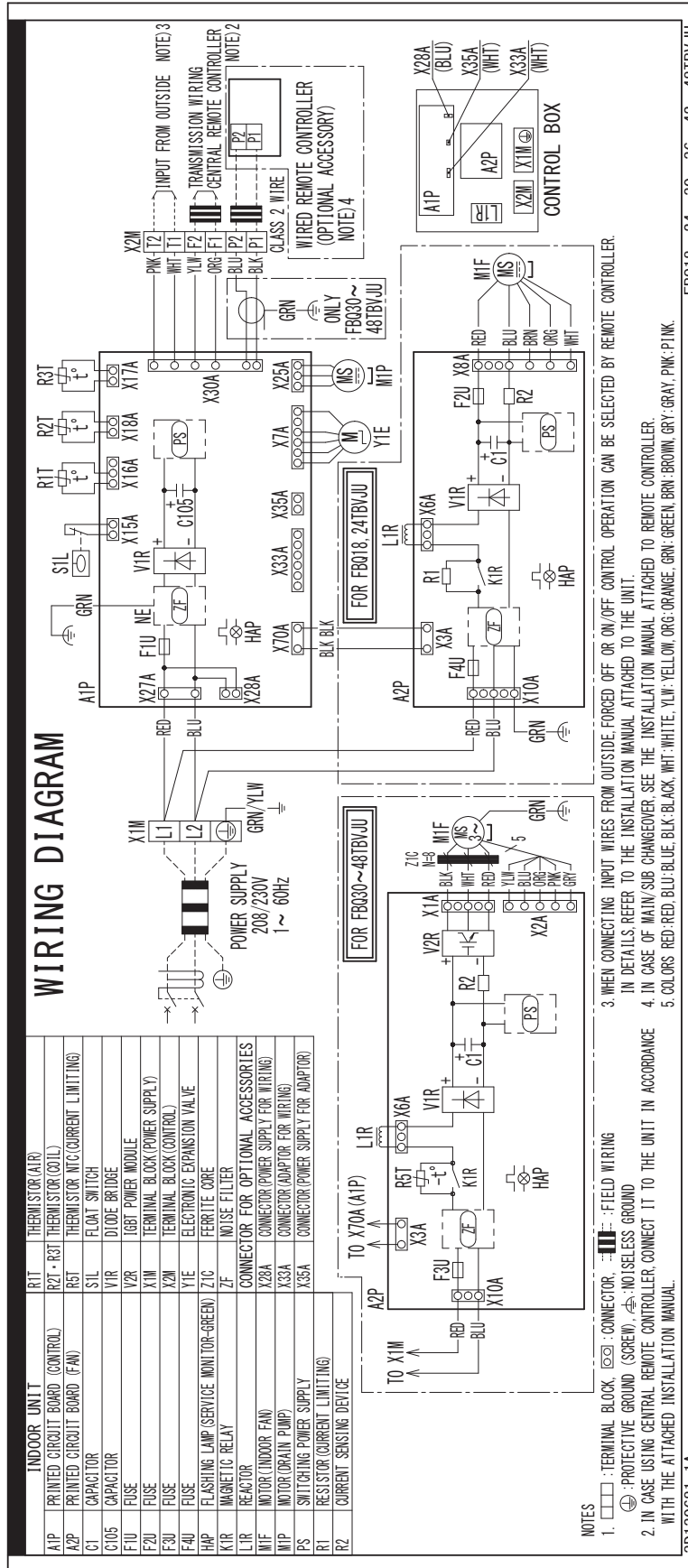

3D130681B

FTQ18/24/30/36/42/48TAVJUD, FTQ18/24/30/36/42/48TAVJUA

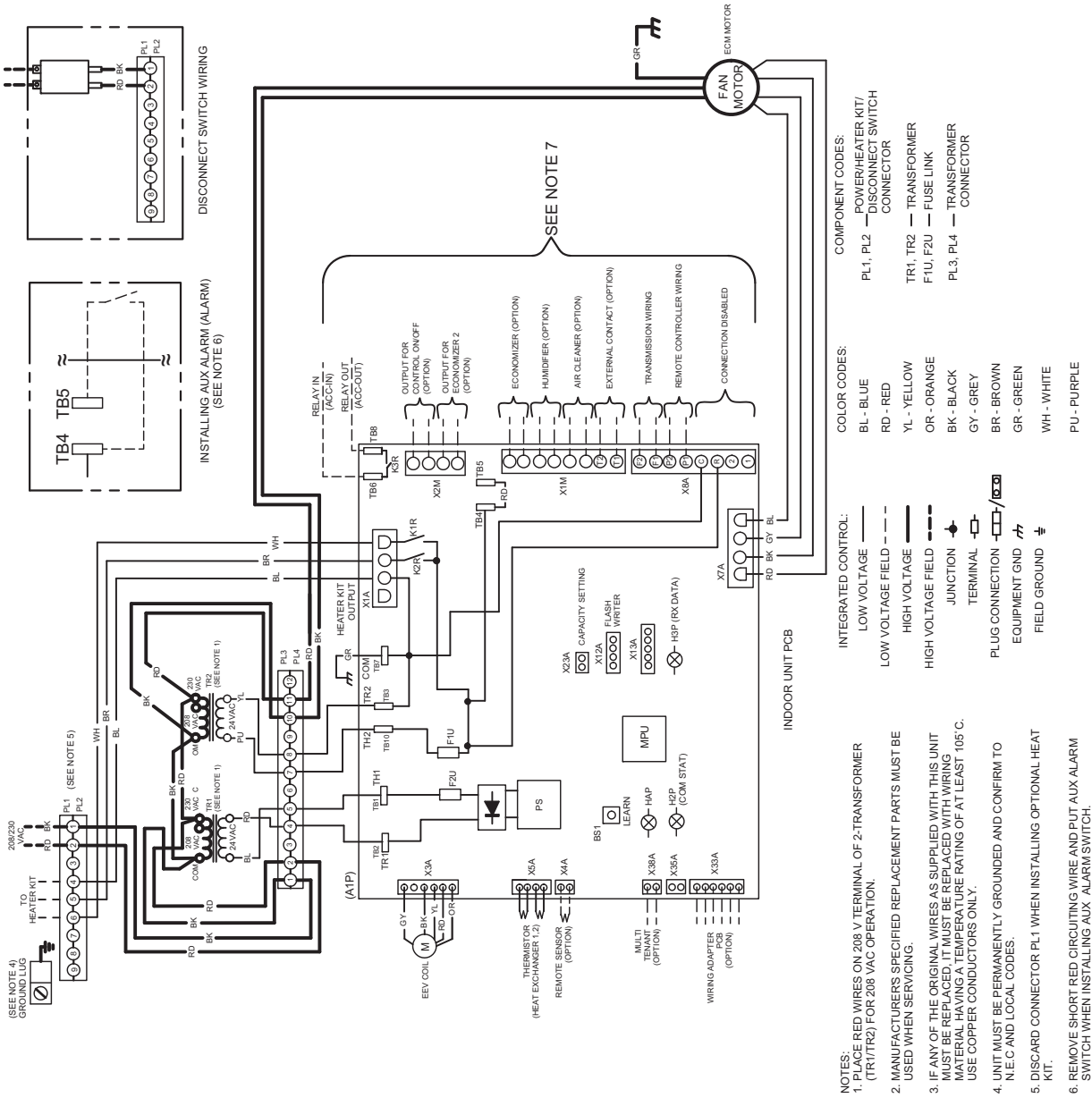

C: 0140A00500A

Warning

- Daikin products are manufactured for export to numerous countries throughout the world. Prior to purchase, please confirm with your local authorized importer, distributor and/or retailer whether this product conforms to the applicable standards, and is suitable for use, in the region where the product will be used. This statement does not purport to exclude, restrict or modify the application of any local legislation.
- Ask a qualified installer or contractor to install this product. Do not try to install the product yourself. Improper installation can result in water or refrigerant leakage, electrical shock, fire or explosion.
- Use only those parts and accessories supplied or specified by Daikin. Ask a qualified installer or contractor to install those parts and accessories. Use of unauthorized parts and accessories or improper installation of parts and accessories can result in water or refrigerant leakage, electrical shock, fire or explosion.
- Read the user's manual carefully before using this product. The user's manual provides important safety instructions and warnings. Be sure to follow these instructions and warnings.

If you have any inquiries, please contact your local importer, distributor and/or retailer.

Cautions on product corrosion

1. Air conditioners should not be installed in areas where corrosive gases, such as acid gas or alkaline gas, are produced.
2. If the outdoor unit is to be installed close to the sea shore, direct exposure to the sea breeze should be avoided. If you need to install the outdoor unit close to the sea shore, contact your local distributor.

© All rights reserved