

# INSTALLATION MANUAL

## Residential VRV System Air Conditioner

MODEL

**RXSQ24TBVJUA**  
**RXSQ36TBVJUA**  
**RXSQ48TBVJUA**

**Installation manual**  
**Residential VRV System air conditioner**

English

**Manuel d'installation**  
**Climatiseur à système VRV résidentiel**

Français

**Manual de instalación**  
**Acondicionador residencial de aire sistema VRV**

Español

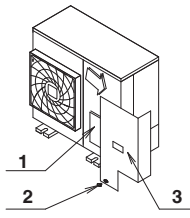

figure 1

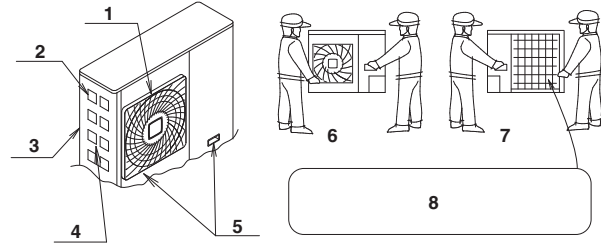

figure 2

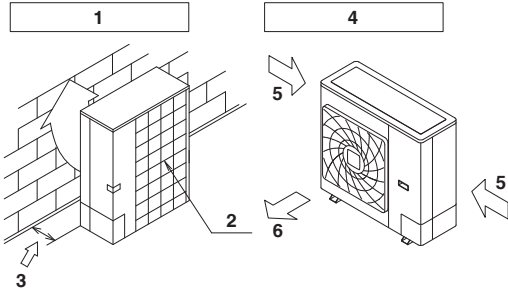

figure 3

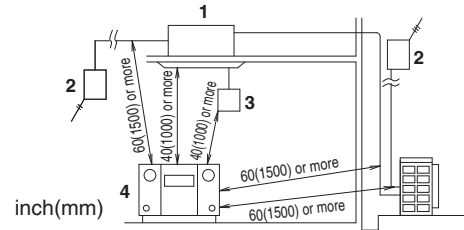

figure 4

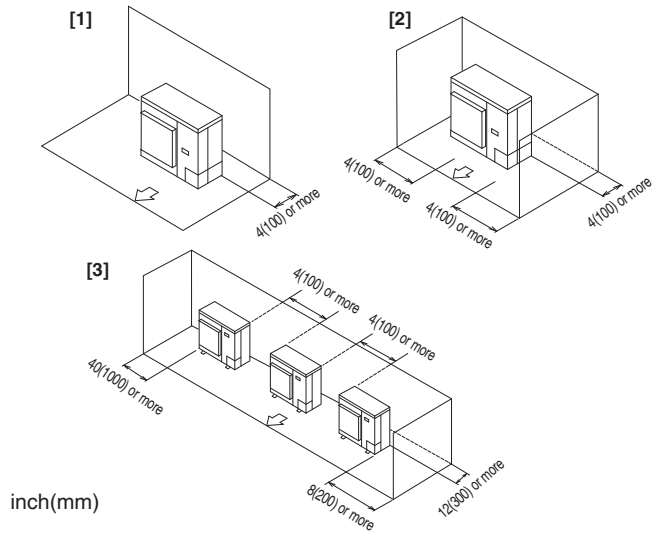

figure 5

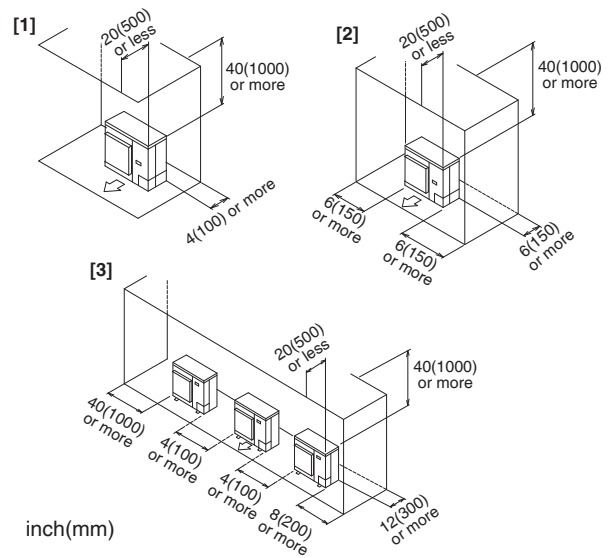

figure 6

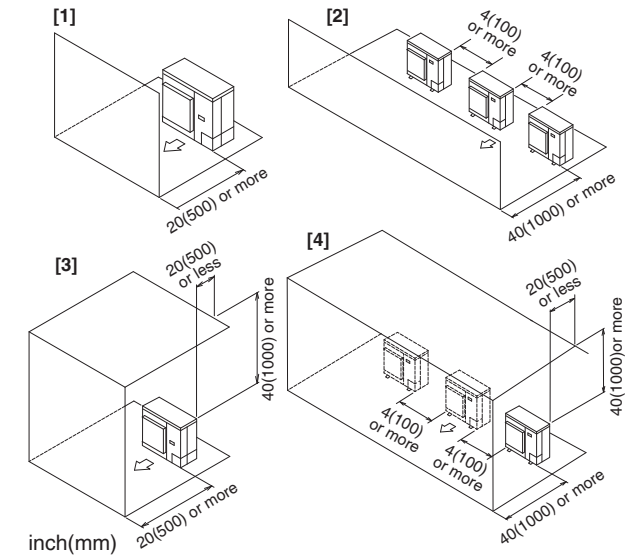

figure 7

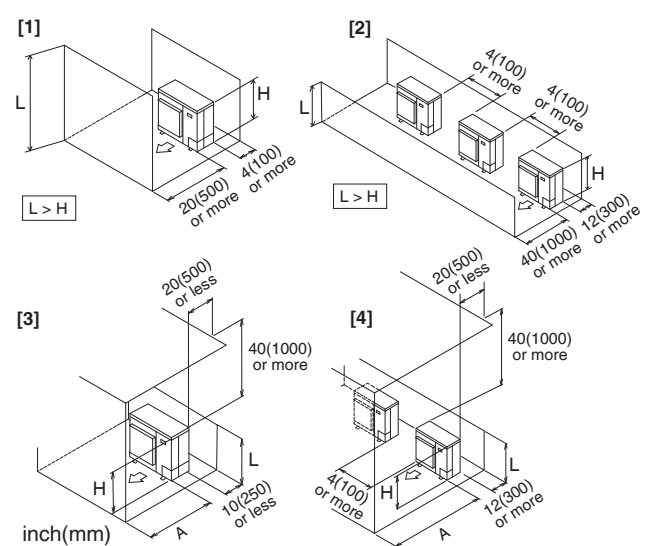

figure 8

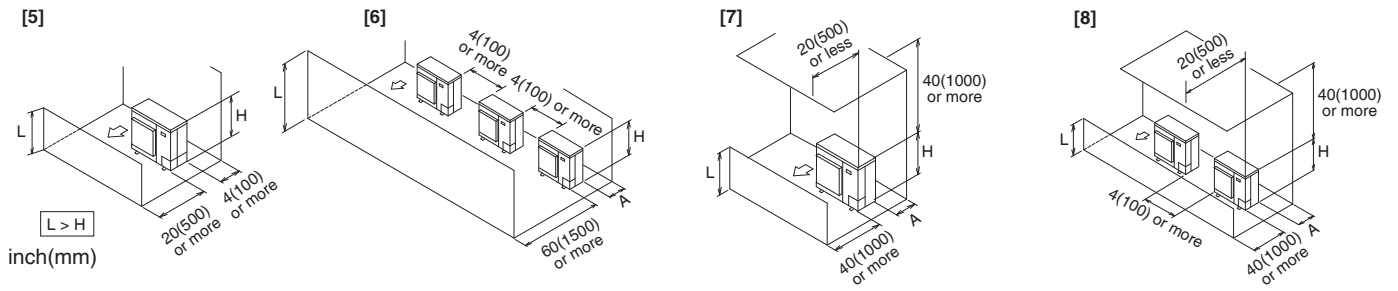

figure 8

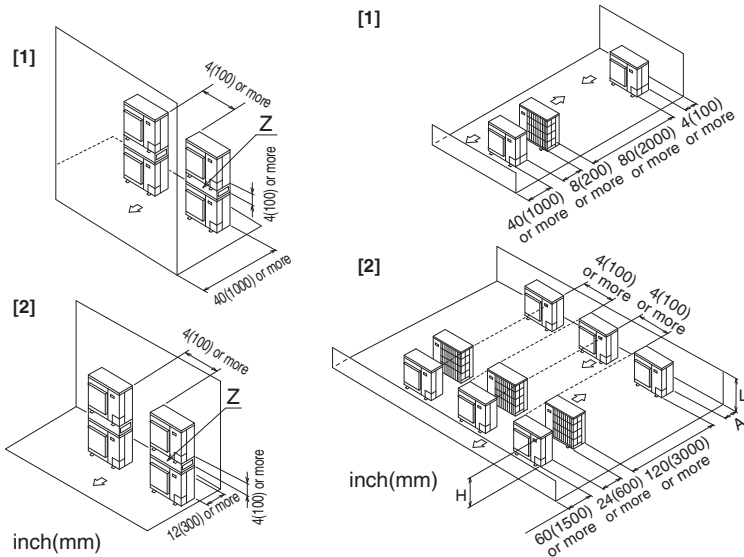
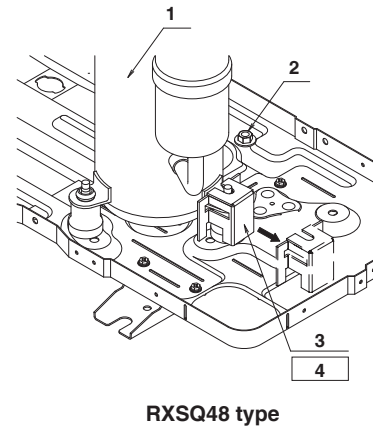

figure 9

figure 10



RXSQ48 type

figure 14

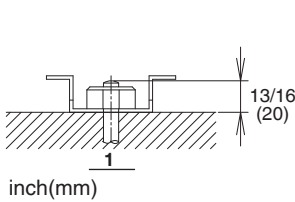

figure 11

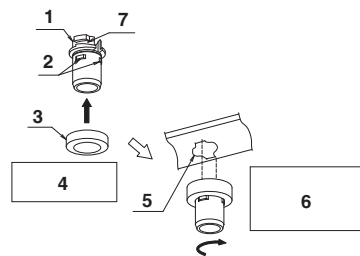

figure 12

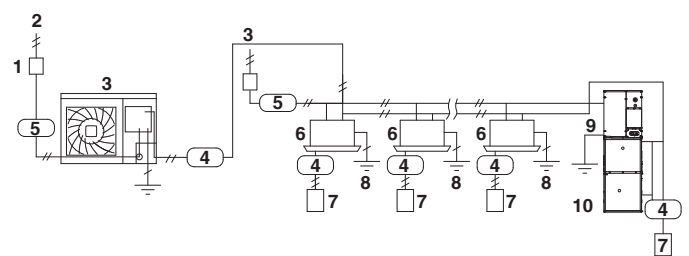

figure 15

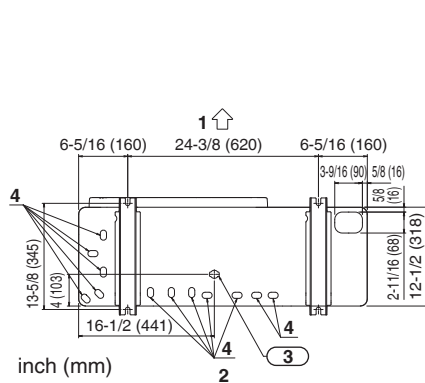

figure 13

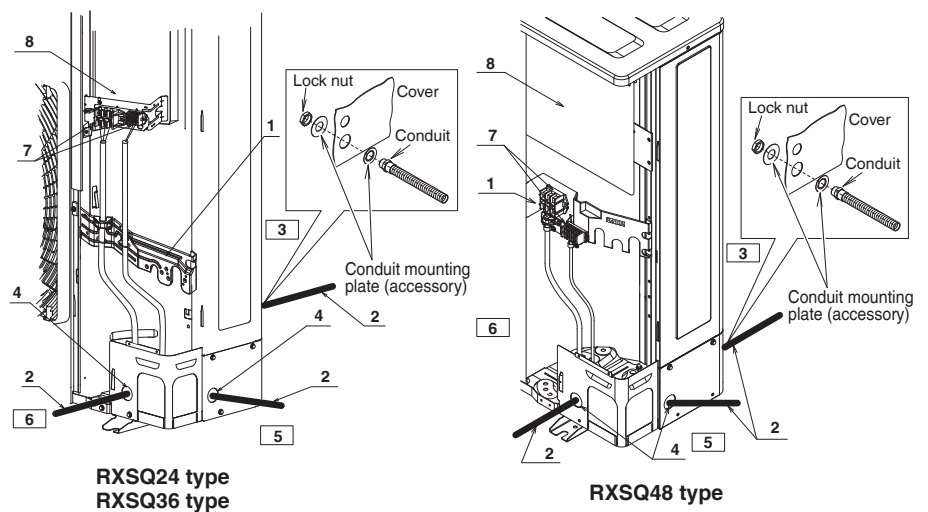
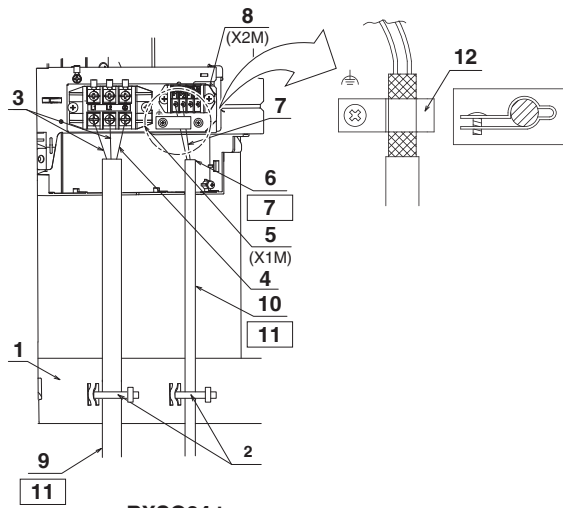
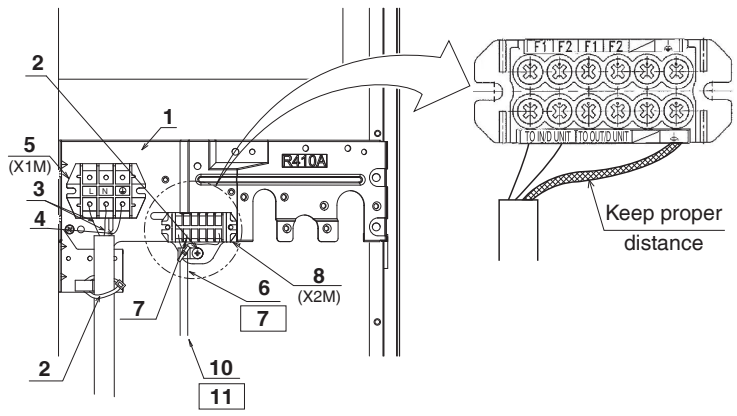

figure 16



RXSQ24 type  
RXSQ36 type



RXSQ48 type

figure 17

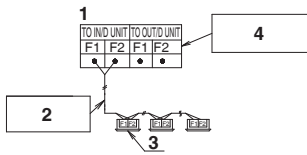

figure 18

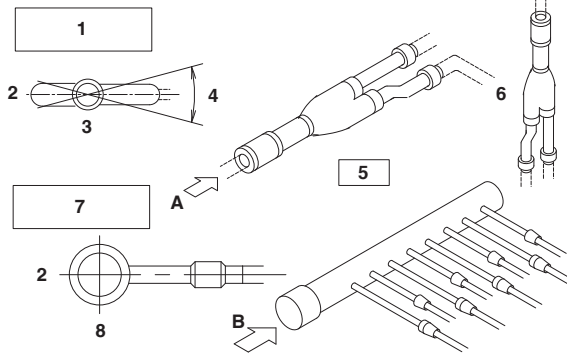

figure 20

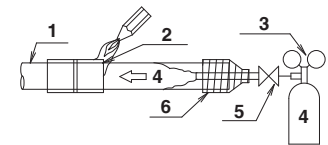

figure 21

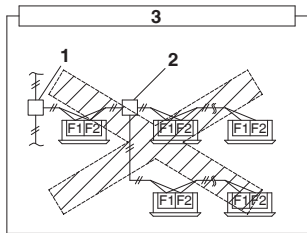

figure 19

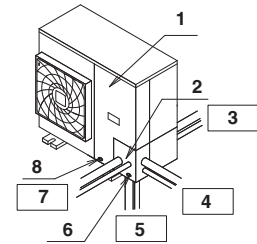

figure 22

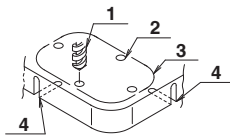

figure 23

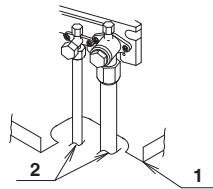

figure 24

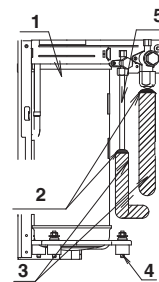

figure 25

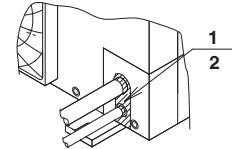

figure 26

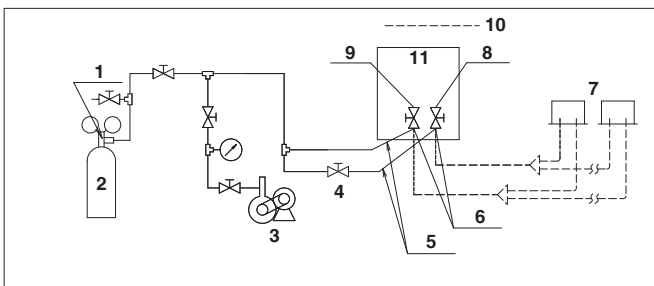

figure 27

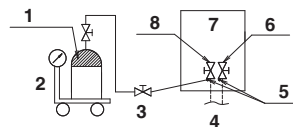

figure 28

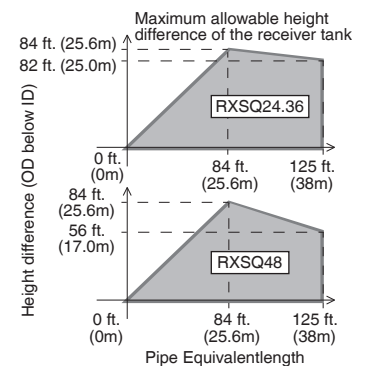

figure 29

## CONTENTS

1. SAFETY CONSIDERATIONS .....	1
2. INTRODUCTION.....	2
2-1. Combination .....	3
2-2. Standard operation limit .....	3
2-3. Standard supplied accessories .....	3
2-4. Option accessory .....	3
3. BEFORE INSTALLATION.....	3
4. SELECTING INSTALLATION SITE .....	3
5. PRECAUTIONS ON INSTALLATION .....	5
6. FIELD WIRING.....	6
6-1. Wiring connection example for whole system .....	6
6-2. How to lay the power supply wiring and transmission wiring.....	6
6-3. How to connect the power supply wiring.....	7
6-4. Transmission wiring connection procedure .....	7
7. PRECAUTIONS ON REFRIGERANT PIPING .....	7
7-1. Selecting piping material.....	8
7-2. Protection against contamination when installing pipes .....	8
7-3. Pipe connection.....	8
7-4. Connecting the refrigerant piping .....	8
7-5. Heat insulation of piping.....	9
7-6. Example of connection.....	10
7-7. Additional refrigerant charge amount.....	11
7-8. Air tight test and vacuum drying .....	12
8. ADDITIONAL REFRIGERANT CHARGE .....	13
8-1. Before adding refrigerant .....	13
8-2. Checking the refrigerant tank .....	13
8-3. Adding refrigerant.....	13
9. POST-WORK CHECKS.....	13
10. TEST RUN .....	13
10-1. Power On—Check Operation .....	13
10-2. Temperature control operation checklist .....	14
10-3. Final refrigerant charge adjustment .....	15
11. ENERGY SAVING AND OPTIMUM OPERATION .....	15
11-1. Three main operation methods are available:.....	15
11-2. Several comfort settings are available .....	16
11-3. Switch over ambient setting .....	16
11-4. Setting of Heat Pump Lockout and Emergency Heat Mode .....	17
11-5. Setting of larger pipe connection and no insulation on liquid line.....	19
12. CAUTION FOR REFRIGERANT LEAKS .....	21

## 1. SAFETY CONSIDERATIONS

Read these “SAFETY CONSIDERATIONS for Installation” carefully before installing air conditioning equipment. After completing the installation, make sure that the unit operates properly during the startup operation.

Instruct the customer on how to operate and maintain the unit. Inform customers that they should store this Installation Manual with the Operation Manual for future reference.

Always use a licensed installer or contractor to install this product.

Improper installation can result in water or refrigerant leakage, electrical shock, fire, or explosion.

Meanings of **DANGER**, **WARNING**, **CAUTION**, and **NOTE** Symbols:

 **DANGER** ..... Indicates an imminently hazardous situation which, if not avoided, will result in death or serious injury.

 **WARNING** .... Indicates a potentially hazardous situation which, if not avoided, could result in death or serious injury.

 **CAUTION** ..... Indicates a potentially hazardous situation which, if not avoided, may result in minor or moderate injury. It may also be used to alert against unsafe practices.

 **NOTE**..... Indicates situations that may result in equipment or property damage accidents only.

### **DANGER**

- Refrigerant gas is heavier than air and replaces oxygen. A massive leak will result in oxygen depletion, especially in basements, and an asphyxiation hazard will result in serious injury or death.
- Do not ground units to water pipes, gas pipes, telephone wires, or lightning rods as incomplete grounding will result a severe shock hazard resulting in severe injury or death. Additionally, grounding to gas pipes will result a gas leak and potential explosion resulting in severe injury or death.
- If refrigerant gas leaks during installation, ventilate the area immediately. Refrigerant gas will result in producing toxic gas if it comes into contact with fire. Exposure to this gas will result in severe injury or death.
- After completing the installation work, check that the refrigerant gas does not leak throughout the system.
- Do not install unit in an area where flammable materials are present due to risk of explosions that will result in serious injury or death.
- Safely dispose all packing and transportation materials in accordance with federal/state/local laws or ordinances. Packing materials such as nails and other metal or wood parts, including plastic packing materials used for transportation will result in injuries or death by suffocation.

### **WARNING**

- Only qualified personnel must carry out the installation work. Installation must be done in accordance with this installation manual. Improper installation could result in water leakage, electric shock, or fire.
- When installing the unit in a small room, take measures to keep the refrigerant concentration from exceeding allowable safety limits. Excessive refrigerant leaks, in the event of an accident in a closed ambient space, could result in oxygen deficiency.
- Use only specified accessories and parts for installation work. Failure to use specified parts could result in water leakage, electric shocks, fire, or the unit falling.
- Install the air conditioner or heat pump on a foundation strong enough that it can withstand the weight of the unit. A foundation of insufficient strength could result in the unit falling and causing injuries.
- Take into account strong winds, typhoons, or earthquakes when installing. Improper installation could result in the unit falling and causing accidents.
- Make sure that a separate power supply circuit is provided for this unit and that all electrical work is carried out by qualified personnel according to local, state and national regulations. An insufficient power supply capacity or improper electrical construction could result in electric shocks or fire.
- Make sure that all wiring is secured, that specified wires are used, and that no external forces act on the terminal connections or wires. Improper connections or installation could result in fire.
- When wiring, position the wires so that the control box cover can be securely fastened. Improper positioning of the control box cover could result in electric shocks, fire, or the terminals overheating.
- Before touching electrical parts, turn off the unit.
- This equipment can be installed with a Ground-Fault Circuit Interrupter (GFCI). Although this is a recognized measure for additional protection, with the grounding system in North America, a dedicated GFCI is not necessary.

- Securely fasten the unit terminal cover (panel). If the terminal cover/panel is not installed properly, dust or water may enter the outdoor unit and could result in fire or electric shock.
- When installing or relocating the system, keep the refrigerant circuit free from substances other than the specified refrigerant (R410A) such as air. Any presence of air or other foreign substance in the refrigerant circuit could result in abnormal pressure rise or rupture, resulting in injury.
- Do not change the setting of the protection devices. If the pressure switch, thermal switch, or other protection device is shorted and operated forcibly, or parts other than those specified by Daikin are used, fire or explosion could result.

---

**⚠ CAUTION**

- Do not touch the switch with wet fingers. Touching a switch with wet fingers may result in electric shock.
- Do not allow children to play on or around the unit or it may result in injury.
- The heat exchanger fins are sharp enough to cut, and may result in injury if improperly used. To avoid injury wear glove or cover the fins when working around them.
- Do not touch the refrigerant pipes during and immediately after operation as the refrigerant pipes may be hot or cold, depending on the condition of the refrigerant flowing through the refrigerant piping, compressor, and other refrigerant cycle parts. It may result in your hands getting burns or frostbite if you touch the refrigerant pipes.  
To avoid injury, give the pipes time to return to normal temperature or, if you must touch them, be sure to wear proper gloves.
- Install drain piping to proper drainage. Improper drain piping may result in water leakage and property damage.
- Insulate piping to prevent condensation.
- Be careful when transporting the product.
- Do not turn off the power immediately after stopping operation. Always wait for at least 5 minutes before turning off the power. Otherwise, water leakage may result.
- Do not use a charging cylinder. Using a charging cylinder may cause the refrigerant to deteriorate.
- Refrigerant R410A in the system must be kept clean, dry, and tight.
  - (a) Clean and Dry - Foreign materials (including mineral oils such as SUNISO oil or moisture) should be prevented from getting into the system.
  - (b) Tight - R410A does not contain any chlorine, does not destroy the ozone layer, and does not reduce the earth's protection against harmful ultraviolet radiation.  
R410A can contribute to the greenhouse effect if it is released. Therefore take proper measures to check for the tightness of the refrigerant piping installation.  
Read the chapter Refrigerant Piping and follow the procedures.
- Since R410A is a blend, the required additional refrigerant must be charged in its liquid state. If the refrigerant is charged in a state of gas, its composition can change and the system will not work properly.
- The indoor unit is for R410A. See the catalog for indoor models that can be connected. Normal operation is not possible when connected to other units.
- Remote controller (wireless kit) transmitting distance can be shorter than expected in rooms with electronic fluorescent lamps (inverter or rapid start types). Install the indoor unit far away from fluorescent lamps as much as possible.
- Indoor units are for indoor installation only. Outdoor units can be installed either outdoors or indoors. This unit is for outdoor use.
- Do not install the air conditioner or heat pump in the following locations:
  - (a) Where a mineral oil mist or oil spray or vapor is produced, for example, in a kitchen.  
Plastic parts may deteriorate and fall off and thus may result in water leakage.

- (b) Where corrosive gas, such as sulfurous acid gas, is produced.  
Corroding copper pipes or soldered parts may result in refrigerant leakage.
  - (c) Near machinery emitting electromagnetic waves.  
Electromagnetic waves may disturb the operation of the control system and cause the unit to malfunction.
  - (d) Where flammable gas may leak, where there is carbon fiber, or ignitable dust suspension in the air, or where volatile flammables such as thinner or gasoline are handled. Operating the unit in such conditions may result in a fire.
- Take adequate measures to prevent the outdoor unit from being used as a shelter by small animals. Small animals making contact with electrical parts may result in malfunctions, smoke, or fire. Instruct the customer to keep the area around the unit clean.

---

**⚠ NOTE**

- Install the power supply and transmission wires for the indoor and outdoor units at least 3.5 ft. (1 m) away from televisions or radios to prevent image interference or noise.  
Depending on the radio waves, a distance of 3.5 ft. (1 m) may not be sufficient to eliminate the noise.
- Dismantling the unit, treatment of the refrigerant, oil and additional parts must be done in accordance with the relevant local, state, and national regulations.
- Do not use the following tools that are used with conventional refrigerants: gauge manifold, charge hose, gas leak detector, reverse flow check valve, refrigerant charge base, vacuum gauge, or refrigerant recovery equipment.
- If the conventional refrigerant and refrigerator oil are mixed in R410A, the refrigerant result in deterioration.
- This air conditioner or heat pump is an appliance that should not be accessible to the general public.
- As design pressure is 478 psi (3.3 MPa), the wall thickness of field-installed pipes should be selected in accordance with the relevant local, state, and national regulations.

---

## Codes and Regulations

This product is designed and manufactured to comply with national codes. Installation in accordance with such codes and/or prevailing local codes/regulations is the responsibility of the installer. The manufacturer assumes no responsibility for equipment installed in violation of any codes or regulations. Rated performance is achieved after 20 hours of operation.

## 2. INTRODUCTION

1. This series uses R410A refrigerant. Be absolutely sure to comply with "7. PRECAUTIONS ON REFRIGERANT PIPING", because even greater caution is needed to prevent impurities from entering R410A (mineral oils and water).
2. The design pressure is 478psi (3.3MPa), which means that piping may be thicker than conventionally, so please refer to "7. PRECAUTIONS ON REFRIGERANT PIPING".
3. This is a mixed refrigerant, so charge as a liquid when adding refrigerant. (If charged as a gas, the composition of the refrigerant may change, preventing normal operation.)
4. The indoor unit must use R410A. See the catalog for indoor unit models which can be connected. (Normal operation is not possible when connected to other units.)
5. The power supply of this series is single-phase, 208/230V, 60Hz.

## 2-1 Combination

The indoor units can be installed in the following range.

- **Be sure to connect a dedicated indoor unit. See the catalog for indoor unit models which can be connected.**
- Total capacity/quantity of indoor units

(Outdoor unit)	(Total capacity of indoor units)	(Total quantity of indoor units)
RXSQ24 type.....	3.6 - 9.2kW 12.0-31.2 MBh	4 units
RXSQ36 type.....	5.3-13.7kW 18.0-46.8 MBh	6 units
RXSQ48 type.....	7.0 - 18.3kW 24.0-62.4 MBh	8 units

	VRV ID units and G/F connection	Pair connection with G/F
System	<p><b>【Required Option】</b> Receiver Tank</p>	
	<p>Connection with multiple G/Fs</p> <p>• Combination with VRV ID units is not allowed. • G/F heating only by the heat pump lockout function. (Heat pump heating is not available.) ※It should set the field setting #2-57 and indoor unit setting. If the setting is not set, heating malfunction may occur.</p>	VRV Indoor units only 

## 2-2 Standard operation limit

### Normal operation

The figures below assume following operating conditions for indoor and outdoor units:

Equivalent pipe length.....	25ft. (7.6m)
Level difference.....	0ft. (0m)

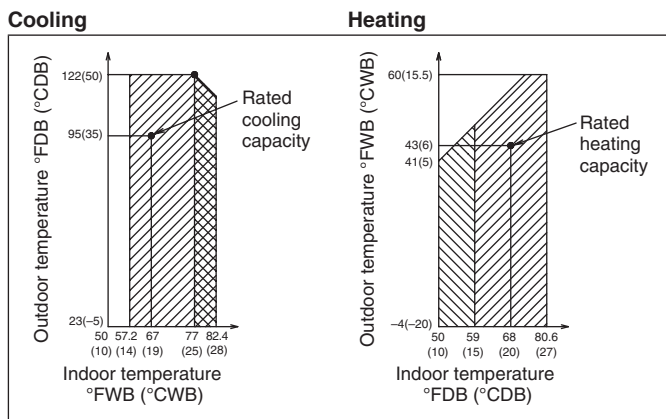

- Range for operation
- Range for pull down operation
- Range for warming up operation

## 2-3 Standard supplied accessories

Make sure that the accessories shown below are all present.

(The accessories can be found behind the front panel.)

Name	Operation manual	Clamp	Conduit mounting plate	
Quantity	1	4 pcs.	2 pcs.	2 pcs.
Shape				

Name	Wire clamp and screw	Insulation tube		Installation manual
Quantity	1 (only 36 type)	1 pc.	1 pc.	1
Shape				

(Refer to figure 1)

1. Accessories
2. Screw for front panel
3. Front panel

## 2-4 Option accessory

- Refrigerant branching kit

REFNET joint	KHRP26A22T9	
REFNET header	KHRP26M22H9	KHRP26M33H9
Vessel kit	BHL-02A	

\* See "7. PRECAUTIONS ON REFRIGERANT PIPING" for details on how to connect refrigerant branch kits and how many are needed.

## 3. BEFORE INSTALLATION

### <Transporting the Unit>

As shown in figure 2, bring the unit slowly. (Take care not to let hands or things come in contact with rear fins.)

(Refer to figure 2)

1. Air outlet grille
2. Intake hole
3. Corner
4. Outdoor unit
5. Handle
6. Front
7. Rear
8. Always hold the unit by the corners, as holding it by the side intake holes on the casing may cause them to deform.

Use only accessories and parts which are of the designated specification when installing.

## 4. SELECTING INSTALLATION SITE

(1) Select an installation site where the following conditions are satisfied and that meets with your customer's approval.

- Places which are well-ventilated.
- Places where the unit does not bother next-door neighbors.
- A location where small animals will not make nests in the unit.
- Safe places which can withstand the unit's weight and vibration and where the unit can be installed level.

- A locations where there is enough space to install the unit.
- Places where the indoor and outdoor unit's piping and wiring lengths come within the allowable ranges.
- A location where there is no risk of flammable gas leaking.

**(2) If the unit is installed in a location where it might be exposed to strong wind, install as per figure 3.**

- 11 mph (5 m/s) or higher winds blown against the outdoor unit's exhaust cause a deterioration in the system performance. High winds force re-circulation of the exhaust air into the inlet, which is known to cause the following effects:
  - Reduction in performance.
  - Increased frost formation in heating mode.
  - System shut down due to increased pressures.
- If very strong wind blows continuously on the air outlet side of the outdoor unit, the fan may turn in reverse at high speed and break, so install as per figure 3.

**(Refer to figure 3)**

1. Turn the air outlet side toward the building's wall, fence or windbreak screen.
2. Air inlet grille
3. Ensure there is enough space for installing the unit.
4. Set the outlet side at a right angle to the direction of the wind.
5. Strong wind
6. Blown air

**(3) When installing the unit in a place frequently exposed to snow, pay special attention to the following:**

- Install the outdoor unit on a stand (field supply), so that the bottom frame is more than 20 in. (500 mm) higher than the expected snow fall to prevent it from being covered by snow.
- Attach a snow hood (field supply) and a snow vizor (field supply).
- Avoid installation at the place where a snowdrift is generated.
- Further, perform the following countermeasures, since there is risk that the drain water produced at the defrost operation freezes.
- Install the outdoor unit so that its bottom place level has a sufficient height from foundation level, so that ice does not grow at the lower surface of the bottom place of the outdoor unit. (Recommended clearance: 20 in. (500 mm) or more)
- In areas where the outside air temperature drops below 32°F (0°C) for more than 12 hours continuously, install a drain-pan heater (optional accessory) on the bottom frame to prevent the drain from freezing.
- An optional drain pan heater is available when the unit is installed in a climate where the drain may freeze.
- The installer should use their local knowledge to determine if this accessory is necessary to prevent the drain from freezing.
- Do not use a concentrated drain plug (field supply). (If a drain plug and/or drain pipe are/is used, there is a risk of freezing.)
- If there is a problem with drain dripping from the bottom frame drain, set up a roof (field supply) below the outdoor unit, or enact other countermeasures.
- Remove the rear inlet grille to prevent snow from accumulating on the rear fins.

**(4) When there is possibility of short-circuit depending on the ambient situation, use the wind direction adjusting plate (optional accessory).**

**(5) The refrigerant gas (R410A) is a safe, non-toxic and non-flammable gas, but if it leaks into the room, the concentration may exceed tolerance levels, especially in small rooms, so steps need to be taken to prevent refrigerant leakage. See the equipment design reference for details.**

**(6) Inverter-type air conditioners sometimes cause static in other electrical appliances.**

When selecting an installation location, make sure the air conditioner and all wiring are sufficiently far away from radios, computers, stereos, and other appliances, as shown in figure 4. Particularly for locations with weak reception, ensure there is a distance of at least 9.8ft. (3 m) for indoor remote controllers, place power supply wiring and transmission wiring in conduits, and ground the conduits. Use non-shielded wire for transmission wiring.

**(Refer to figure 4)**

1. Indoor unit
2. Fuse/Breaker
3. Remote controller
4. Personal computer or radio

**(7) Space needed for installation**

Refer to figure 5~10 for necessary clearance and service space between the refrigerant tank and the unit. Install the tank outside of this space.

**<Precautions when installing units in series>**

- The direction for interunit piping is either forward or down when installing units in series, as shown in the figure(5~10).
- If the piping is brought out from the back, the outdoor unit will require at least 10in. (250 mm) from its right side.

**(7)-1 IN CASE OBSTACLES EXIST ONLY IN FRONT OF THE AIR INLET**

**When nothing is obstructing the top**

1. Installation of single unit
  - In case obstacles exist only in front of the air inlet **(Refer to figure 5-[1])**
  - In case obstacles exist in front of the air inlet and on both sides of the unit **(Refer to figure 5-[2])**
2. In case of installing multiple units (2 units or more) in lateral connection per row
  - In case obstacles exist in front of the air inlet and on both sides of the unit **(Refer to figure 5-[3])**

**When something is obstructing the top**

1. Installation of single unit
  - In case obstacles exist only in front of the air inlet **(Refer to figure 6-[1])**
  - In case obstacles exist in front of the air inlet and on both sides of the unit **(Refer to figure 6-[2])**
2. In case of installing multiple units (2 units or more) in lateral connection per row
  - In case obstacles exist in front of the air inlet and on both sides of the unit **(Refer to figure 6-[3])**

**(7)-2 IN CASE OBSTACLES EXIST IN FRONT OF THE OUTLET SIDE**

**When nothing is obstructing the top**

1. Installation of single unit **(Refer to figure 7-[1])**
2. In case of installing multiple units (2 units or more) in lateral connection per row **(Refer to figure 7-[2])**

**When something is obstructing the top**

1. Installation of single unit **(Refer to figure 7-[3])**
2. In case of installing multiple units (2 units or more) in lateral connection per row **(Refer to figure 7-[4])**

**(7)-3 IN CASE OBSTACLES EXIST IN FRONT OF BOTH THE AIR INLET AND OUTLET SIDES**

**Pattern 1:** Where obstacle in front of the air outlet is higher than the unit. (There is no height limit for obstructions on the intake side.)

**When nothing is obstructing the top**

1. Installation of single unit **(Refer to figure 8-[1])**
2. In case of installing multiple units (2 units or more) in lateral connection per row **(Refer to figure 8-[2])**

**When something is obstructing the top**

1. Installation of single unit **(Refer to figure 8-[3])**

Relation of dimensions of H, A, and L are shown in the table below.  
inch(mm)

	L	A
L ≤ H	0 < L ≤ 1/2H	30(750)
	1/2H < L ≤ H	40(1000)
H < L	Set the frame to be L ≤ H	

**Note)**

Get the lower part of the frame sealed so that air from the outlet does not bypass.



2. Series installation (up to two units) **(Refer to figure 8-[4])**

Relation of dimensions of H, A, and L are shown in the table below.  
inch(mm)

	L	A
L ≤ H	0 < L ≤ 1/2H	40(1000)
	1/2H < L ≤ H	50(1250)
H < L	Set the frame to be L ≤ H	

Note)

1. Get the lower part of the frame sealed so that air from the outlet does not bypass.
2. Only two units at most can be installed in series.

**Pattern 2:** Where obstacles in front of the air outlet is lower than the unit.

(There is no height limit for obstructions on the intake side.)

**When nothing is obstructing the top**

1. Installation of single unit **(Refer to figure 8-[5])**
2. In case of installing multiple units (2 units or more) in lateral connection per row **(Refer to figure 8-[6])**

Relation of dimensions of H, A, and L are shown in the table below.  
inch(mm)

	L	A
L ≤ H	0 < L ≤ 1/2H	10(250)
	1/2H < L ≤ H	12(300)

**When something is obstructing the top**

1. Installation of single unit **(Refer to figure 8-[7])**

Relation of dimensions of H, A, and L are shown in the table below.  
inch(mm)

	L	A
L ≤ H	0 < L ≤ 1/2H	4(100)
	1/2H < L ≤ H	8(200)
H < L	Set the frame to be L ≤ H	

Note)

Get the lower part of the frame sealed so that air from the outlet does not bypass.

2. Series installation (up to two units) **(Refer to figure 8-[8])**

Relation of dimensions of H, A, and L are shown in the table below.  
inch(mm)

	L	A
L ≤ H	0 < L ≤ 1/2H	10(250)
	1/2H < L ≤ H	12(300)
H < L	Set the frame to be L ≤ H	

Note)

1. Get the lower part of the frame sealed so that air from the outlet does not bypass.
2. Only two units at most can be installed in series.

**(7)-4 IN CASE OF STACKED INSTALLATION**

1. In case obstacles exist in front of the outlet side **(Refer to figure 9-[1])**

Note)

1. No more than two units should be stacked.
2. About 4in. (100mm) is required as the dimension for laying the upper outdoor unit's drain pipe.
3. Shut off the Z part (the area between the upper outdoor unit and the lower outdoor unit) so that outlet air does not bypass.

2. In case obstacles exist in front of the air inlet **(Refer to figure 9-[2])**

Note)

1. No more than two units should be stacked.
2. About 4in. (100mm) is required as the dimension for laying the upper outdoor unit's drain pipe.
3. Shut off the Z part (the area between the upper outdoor unit and the lower outdoor unit) so that outlet air does not bypass.

**(7)-5 IN CASE OF MULTIPLE-ROW INSTALLATION (FOR ROOF TOP USE, ETC.)**

1. In case of installing one unit per row **(Refer to figure 10-[1])**
2. In case of installing multiple units (2 units or more) in lateral connection per row **(Refer to figure 10-[2])**

Relation of dimensions of H, A, and L are shown in the table below.  
inch(mm)

	L	A
L ≤ H	0 < L ≤ 1/2H	10(250)
	1/2H < L ≤ H	12(300)
H < L	Installation impossible.	

**5. PRECAUTIONS ON INSTALLATION**

- Before installation, make sure the unit is level and the foundation is sturdy enough to prevent vibration and noise.
- Fasten the unit in place using 4 foundation bolts M12 or equivalent. It is best to screw in the foundation bolt until their length remains 13/16in. (20mm) above the foundation surface.

**(Refer to figure 11)**

1. Diagram of lower surface

**<Drain pipe installation>**

- Locations where drain water from the outdoor unit might be a problem. In such locations, for example, where the drain water might drip onto passersby, lay the drain pipe using the separately sold drain plug and seal up the drain holes in the bottom frame. For details, please contact your dealer.

In case of installing the outdoor unit in cold climates, do not take this centralized drainage way. Otherwise, drain pipe freeze-up and ice build-up on the bottom frame way occur.

- When laying the drain pipe, at least 4in. (100mm) from the bottom of the outdoor unit is needed.
- Make sure the drainage works properly.  
(Watch out for water leaks if piping is brought out the bottom.)

**(Refer to figure 12)**

1. Drain plug
2. 4 tabs
3. Drain receiver
4. Insert the drain receiver into the drain plug and hook the tabs.
5. Bottom frame drain hole
6. (1) Insert the drain plug through the drain hole in the bottom frame shown in figure 13.  
(2) Turn the drain plug along the guides until it stops (approx. 40°).
7. Guide

**(Refer to figure 13)**

1. Air outlet side
2. Diagram of lower surface
3. Drain hole (For plug)
4. Drain hole

**[How to remove the transport clasp](RXTQ48~)**

- A yellow transport clasp and washer are attached to the legs of the compressor to protect the unit during transportation, so remove them as shown in figure 14.

**(Refer to figure 14)**

1. Compressor
2. Securing nut
3. Transport clasp (Yellow)
4. Turn in the direction of the arrow and remove.

- (1) Open the sound-proof cover as shown in figure 14.

Do not pull the sound-proof cover or remove it from the compressor.

- (2) Remove the securing nut.
- (3) Remove the washer.
- (4) Remove the transport clasp as shown in figure 14.
- (5) Retighten the securing nut.
- (6) Return the sound-proof cover as it was.

## 6. FIELD WIRING

### CAUTION

#### To the electrician

- Do not operate until refrigerant piping work is completed. (Failure to adhere by this caution may lead to irreparable compressor damage.)

### 6-1 Wiring connection example for whole system

- Electrical wiring work should be done by a certified professional.
- Follow the "Electrical wiring diagram face plate" when carrying out any electrical wiring.  
Only proceed with wiring work after blocking off all power.
- Always ground wires in accordance with relevant local and national regulations.
- Ground the indoor and outdoor units.
- Do not connect the ground wire to gas pipes, sewage pipes, lightning rods, or telephone ground wires.
  - Gas pipes:** can explode or catch fire if there is a gas leak.
  - Sewage pipes:** no grounding effect is possible if hard plastic piping is used.
  - Telephone ground wires and lightning rods:** dangerous when struck by lightning due to abnormal rise in electrical potential in the grounding.
- Use copper wire.
- When doing the electrical wiring, always shut off the power source before working, and do not turn on the switch until all work is complete.
- This unit has an inverter, so it must be grounded in order to reduce noise and prevent it affecting other appliances, and also to release any electrical build-up in the unit case due to leaked current.
- Do not install a power-factor improving phase-advancing capacitor under any circumstances. (Not only will this not improve the power factor, but it might cause a fire.)
- Connect the wire securely using designated wire and fix it with attached clamp without applying external pressure on the terminal parts (terminal for power wiring, terminal for transmission wiring and earth terminal). See "6-3 How to connect the power supply wiring".
- Left-over wiring should not be wrapped and stuffed into the unit.
- To prevent the power wiring from being damaged by the knock hole edges, put it in a wiring pipe or plastic tube to protect it.
- Secure the wiring with the included clamp so that it does not come in contact with the piping or stop valve. (See "6-3 How to connect the power supply wiring".)

### CAUTION

- Use a power wire pipe for the power supply wiring.
- Outside the unit, make sure the communication wiring (i.e. for the remote controller cord, between units, etc.) and the high voltage wiring do not pass near each other, **keeping them at least 2in.(50mm) apart**. Proximity may cause electrical interference, malfunctions, and breakage.
- Be sure to connect the power wiring to the power wiring terminal block and secure it as described in "6-3 How to connect the power supply wiring".
- Transmission wiring should be secured as described in "6-4 Transmission wiring connection procedure".
- Secure wiring with clamp (accessory) to avoid contact with piping.
- Make sure the wiring and the front panel do not stick up above the structure, and close the cover firmly.

#### (Refer to figure 15)

- Fuse/Breaker
- Power supply
- Outdoor unit

- 16V
- 208/230V
- Indoor unit
- Remote controller
- Ground wire
- Indoor unit (CXTQ\*\*)
- Gas Furnace

### 6-2 How to lay the power supply wiring and transmission wiring

Let the power supply wiring and transmission wiring with a conduit pass through one of the knockout holes on the front or side cover, and let the transmission wiring with a conduit pass through another knockout hole.

- For protection from uninsulated live parts, thread the power supply wiring and the transmission wiring through the included insulation tube and secure it with the included clamp.

#### <Power supply wiring>

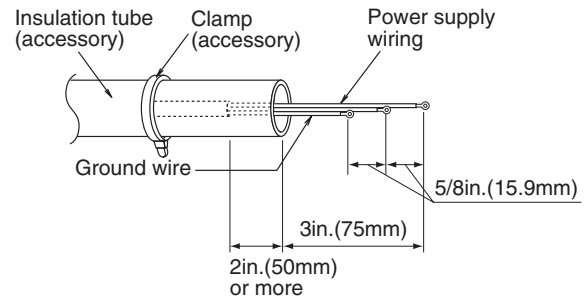

#### <Transmission wiring>

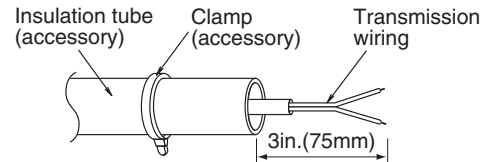

#### Precautions knock out holes

- Open the knock holes with a hammer or the like.
- After knocking out the holes, we recommend you remove burrs in the knock holes and paint the edges and areas around the edges using the repair paint to prevent rusting.
- When passing wiring through knock holes, make sure there are no burrs, and protect the wiring with protective tape.

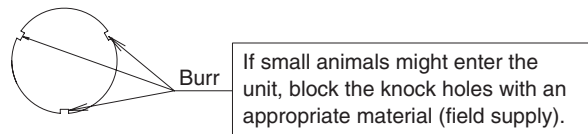

#### (Refer to figure 16)

- Stop valve attachment plate
- Power supply wiring (including ground wire) or transmission wiring.
- Back of unit
- Knockout hole
- Side of unit
- Front of unit
- Terminal block
- Control Box

### <Precautions when laying power wiring>

- Wiring of different thicknesses cannot be connected to the power terminal block.  
(Slack in the power wiring may cause abnormal heat.)
- Use sleeve-insulated round pressure terminals for connections to the power terminal block. When none are available, connect wire of the same diameter to both sides, as shown in the figure.

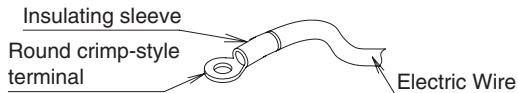

Connect wires of the same gauge to both side.

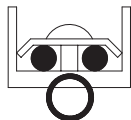

Do not connect wires of the same gauge to one side.

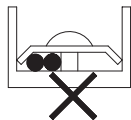

Do not connect wires of different gauges.

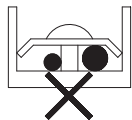

### Follow the instructions below if the wiring gets very hot due to slack in the power wiring.

- For wiring, use the designated power wire and connect firmly, then secure using the included clamping material to prevent outside pressure being exerted on the terminal board.
- Use an appropriate screwdriver for tightening the terminal screws. A screwdriver with a small head will strip the head and make proper tightening impossible.
- Over-tightening the terminal screw may break it.

See the table below the tightening torque of the terminal screws.

Tightening torque (ft-lbf / N·m)		
M5	Power terminal	1.76~2.15 / 2.39~2.91
M4	Shield ground	0.87~1.06 / 1.18~1.44
M3	Transmission wiring terminal block	0.58~0.72 / 0.8~0.97

## 6-3 How to connect the power supply wiring



### CAUTION

Attach a circuit breaker/GFCI.

Model name	Phase and frequency	Voltage	Maximum overcurrent protective device	Minimum circuit ampacity
RXSQ24 type	1~60Hz	208/230V	20A	16.5A
RXSQ36 type	1~60Hz	208/230V	20A	16.5A
RXSQ48 type	1~60Hz	208/230V	35A	29.1A



### CAUTION

- The wiring should be selected in compliance with local laws and regulations. See the table above.
- Always turn off the power before doing wiring work.
- Grounding should be done in compliance with local laws and regulations.
- As shown in figure 18, when connecting the power supply wiring to the power supply terminal block, be sure to clamp securely.
- Once wiring work is completed, check to make sure there are no loose connections among the electrical parts in the control box.

(Refer to figure 17)

- Stop valve attachment plate
- Clamp (accessory)
- Connecting power supply wiring

- Ground wire (Yellow/Green)
- Terminal block (X1M)
- Transmission wiring
- (To X2M [TO IN/ D UNIT] (F1, F2))
- Terminal block (X2M)
- Insulation tube (Large) (accessory)
- Insulation tube (Small) (accessory)
- Cut off the insulation tube sticking out of the outdoor unit.
- Wire clamp and screw (accessory)

## 6-4 Transmission wiring connection procedure

- Between indoor units in the same system, pass the wiring between the units as shown in figure 18. (There is no polarity.)

(Refer to figure 18)

- Terminal block (X2M)
- Use balance type shield wire (with no polarity).
- Indoor unit
- Under no circumstances should 208/230V be connected.

### Precautions regarding the length of wiring between units

Exceeding the following limits may cause transmission malfunctions, so observe them.

Max. wiring length	Max. 984ft. (300m)
Total wiring length	Max. 1968ft. (600m)
Max. no. of branches	8

### Precautions regarding wiring between units

- Do not connect 208/230V power wiring to terminals for the transmission wiring. Doing so would destroy the entire system.**
- Wiring to the indoor unit should be wired to F1 and F2 (TO IN/D unit) on the outdoor unit's terminal block (X2M).

### NOTE

- The above wiring should be wired using AWG18-16 stranded, non-shielded wiring.  
(See figure 18 for how to ground the shielded parts.)
- All transmission wiring is to be procured on site.



### CAUTION

Up to 8 branches are available in the wiring among units.

Branch after branch cannot perform wiring between units.

(Refer to figure 19)

- Branch
- Branches after branch points
- Caution on branches in the wiring among units

## 7. PRECAUTIONS ON REFRIGERANT PIPING

- Do not allow anything other than the designated refrigerant to get mixed into the refrigerant cycle, such as air, nitrogen, etc. If any refrigerant gas leaks while working on the unit, ventilate the room thoroughly right away.
- Use R410A only when adding refrigerant.
- Installation tools:
  - Make sure to use installation tools (gauge manifold, charge hose, etc.) that are exclusively used for R410A installations to withstand the pressure and to prevent foreign materials (e.g., mineral oils and moisture) from mixing into the system.
- Vacuum pump:
  - Use a 2-stage vacuum pump with a non-return valve.
  - Make sure the pump oil does not flow oppositely into the system while the pump is not working.
  - Use a vacuum pump which can evacuate to 500 microns.

## 7-1 Selecting piping material

### CAUTION

Piping and other pressure containing parts shall comply with the applicable legislation and shall be suitable for refrigerant. Use phosphoric acid deoxidized seamless copper for refrigerant.

### CAUTION

- All field piping must be installed by a licensed refrigeration technician and must comply with relevant local and national regulations.
- After piping work is complete, do not under any circumstances open the stop valve until **6. FIELD WIRING** on page 6 and **9. POST-WORK CHECKS** on page 13 are complete.
- Do not use flux when brazing the refrigerant piping. Use the phosphor copper brazing filler metal (B-Cu93P-710/795:ISO 3677) which does not require flux. Flux has extremely negative effect on refrigerant piping systems. For instance, if the chlorine based flux is used, it will cause pipe corrosion or, in particular, if the flux contains fluorine, it will damage the refrigerant oil.

- Use only pipes which are clean inside and outside and which do not accumulate harmful sulfur, oxidants, dirt, cutting oils, moisture, or other contamination. (Foreign materials inside pipes including oils for fabrication must be 0.14 gr/10 ft. (30 mg/10 m) or less.)

- Use the following items for the refrigerant piping.

**Material** :Jointless phosphor-deoxidized copper pipe.

**Size** :See 7-6 Example of connection.

**Thickness** :Select a thickness for the refrigerant piping which complies with national and local laws.



- Install the refrigerant branch kit while observing the following condition and referring to the installation manual offered as an accessory of the kit.

(Refer to figure 20)

1. Install the REFNET joint so it splits horizontally or vertically.
2. Horizontal surface
3. A-arrow view
4.  $\pm 30^\circ$  or less
5. Level
6. Vertical is also OK
7. Install the REFNET header so that it splits horizontally.
8. B-arrow view

## 7-2 Protection against contamination when installing pipes

- Wrap the piping to prevent moisture, dirt, dust, etc. from entering the piping.
- Exercise caution when passing copper piping through the through-holes and when passing them out to the outside.

Place	Installation	Protection method
	More than a month	Pinch the pipe
	Less than a month	Pinch or tape the pipe
	Regardless of the period	

- In case existing refrigerant pipes between outdoor and indoor are being re-used, the line set must be flushed with R410A to avoid residual oil from previous system contaminating the new system. Remember to consult and follow all limitations for using existing pipe.

## 7-3 Pipe connection

- See "Stop valve operation procedure" in "7-8 Air tight test and vacuum drying" regarding handling of the stop valve.
- Only use the flare nuts included with the unit. Using different flare nuts may cause the refrigerant to leak.

- **Be sure to perform a nitrogen blow when brazing.**

(Brazing without performing nitrogen replacement or releasing nitrogen into the piping will create large quantities of oxidized film on the inside of the pipes, adversely affecting valves and compressors in the refrigerating system and preventing normal operation.)

(Refer to figure 21)

1. Refrigerant pipe
2. Location to be brazed
3. Regulator
4. Nitrogen
5. Manual valve
6. Taping

## 7-4 Connecting the refrigerant piping

- Connection to larger pipe sizes.  
In certain configurations this system is designed to be connected to larger diameter pipe sizes than the standard factory service valves. If the installation requires use of larger pipe diameters, a field setting change is required for the system to operate smoothly.
- A filter dryer should not be attached to piping.
- The local inter-unit piping is connectable in four directions.

(Refer to figure 22)

1. Front panel
2. Pipe outlet panel
3. Backward
4. Sideways
5. Downward
6. Pipe outlet panel screw
7. Forward
8. Screw for front panel

- **When connecting the pipings downward, remove the knockout by making four holes in the middle on the each side of the knockout with a drill.**

(Refer to figure 23)

1. Drill
2. Center area around knockout hole
3. Knockout hole
4. Slit

- After knocking out the knock-out, it is recommended to apply repair paint to the edge and the surrounding end surfaces to prevent rusting.

(Refer to figure 24)

1. Bottom frame
2. Interunit piping

### Limitations when using existing pipes.

When installing residential VRV you should use the specified pipe diameter sizes and insulate both gas and liquid pipes.

An exception to this would be in a system replacement application where existing piping can be used if the limitations listed below are followed.

1. Limitations when using existing liquid pipes.
  - Observe the piping size of 7-6.
  - Using existing liquid pipes is allowed for the main pipe only. Thermal insulation is required to branch pipes.
  - Insulation is required to accessible liquid pipe exposed outdoors and indoors.
  - Liquid pipes which located under outdoor ambient condition should to be insulated as much as possible.
  - Condensation at non-insulation liquid pipe may cause a problem, field pipe setting (Mode2-4) have to set "1" or "3".
  - If there is a place where insulation can not be installed, add the amount of refrigerant according to "7-7 Additional refrigerant charge amount".
  - Insulation on liquid pipe is required if there is possibility to operate at reversed ambient temperatures between outdoor and indoor (cooling: outdoor<indoor, heating: outdoor>indoor)
2. Limitations when using existing gas pipes.
  - Observe the piping size of 7-6.
  - Using existing liquid pipes is allowed for the main pipe only.

- Insulation is required to all gas pipe.
- When the gas pipe diameter is larger than the specified pipe diameter, add the amount of refrigerant according to “7-7 Additional refrigerant charge amount” term.
- In order to maximize the performance, it is recommended to use standard size piping and install insulation. On both liquid and gas pipes.
- Main pipe: Main pipe means the field line set from the stop valve to the first branch.
- Branch pipe: Branch pipe means the field line set from the first branch to indoor units.

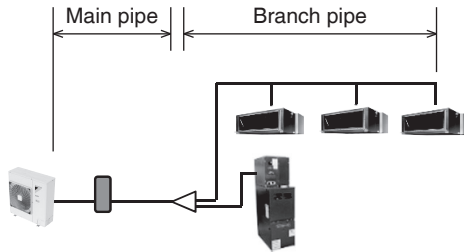

- In installations where existing refrigerant pipes are being used; and the pipes are not accessible to the installer, ensure that all visible piping is insulated. The refrigerant pipes between the outdoor unit and wall must be insulated if any portion of the un-accessible liquid pipe cannot be insulated. In addition to this, a field setting change is required to enable to system to operate smoothly in such installations. Failure to follow the instruction may lead to damage due to sweating and cause compressor damage and void warranty.
- In case of “no-insulation” on liquid line, when ambient temperature is “low,” the system may cycle the fan off for thermo-off unit and fan only unit. While the off cycle is engaged, the thermostat will display a temporary “standby” message until the system recovers from the off cycle and the fan operation continues.
- The field setting for indoor units are also required. Selection of thermistor is only remote controller thermistor. See the indoor installation manual.

**NOTE**

Cutting out the two slits makes it possible to install as shown in figure 24. (Use a metal saw to cut out the slits.)

**<Precautions when connecting pipes>**

- Please refer to the Table 1 for the dimensions for processing flares.
- When connecting the flare nut, coat the flare both inside and outside with refrigerating machine oil and initially tighten by hand 3 or 4 turns before tightening firmly.
- Please refer to the Table 1 for the tightening torque. (Too much tightening will end up in splitting of the flare.)

Table 1

Pipe size (in.)	Tightening torque (ft-lbf)	A dimensions for processing flares (in.)	Flare shape (in.)
φ 3/8" (9.5mm)	24.1~29.4 (32.7-39.9N·m)	0.504~0.520 (12.8-13.2mm)	
φ 5/8" (15.9mm)	45.6~55.6 (61.8-75.4N·m)	0.760~0.776 (19.3-19.7mm)	

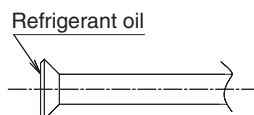

- If a torque wrench is not available, there is a place where the tightening torque will suddenly increase if a normal wrench is used to tighten the flare nut. From that position, further tighten the flare nut the angle shown below.

Pipe size	Further tightening angle	Recommended arm length of tool (in.)
φ 3/8" (9.5mm)	60°~ 90°	Approx. 7 7/8 (200mm)
φ 5/8" (15.9mm)	30°~ 60°	Approx. 11 13/16 (300mm)

- After all the piping has been connected, use nitrogen to perform a gas leak check.

**Precautions for connecting pipes**

- Be careful not to let the interunit piping come into contact with the compressor terminal cover. Adjust the height of the insulation material on liquid pipe when it has the possibility of getting in contact with the terminal. Also make sure that the interunit piping does not touch the mounting bolt of the compressor.

**(Refer to figure 25)**

1. Compressor
2. Corking, etc.
3. Insulation material
4. Bolts
5. Interunit piping

- If installing the outdoor unit higher than the indoor unit, caulk the space around insulation and tubes because condensation on the check valve can seep through to the indoor unit side.

**[Preventing foreign objects from entering]**

- Plug the pipe through-holes with putty or insulating material (pro cured locally) to stop up all gaps, as shown in figure 26. (Figure 26 indicates the forward case. Do the same in case of other directions.) Insects or small animals entering the outdoor unit may cause a short in the control box.

**(Refer to figure 26)**

1. Putty or insulating material
2. (field supply)

Refer to BHL-02A IO when brazing vessel kit to the system.

**7-5 Heat insulation of piping**

- Highly recommended to insulate the interunit piping (liquid and gas-side) and the refrigerant branch kit. (Not insulating them may cause leaking.)
- The insulation dimension is recommended as following:

Ambient temperature: 86°F (30°C), humidity : Below 80% RH	Ambient temperature: 86°F (30°C), humidity : 80% RH and above
Minimum thickness : 9/16 inch (15mm)	Minimum thickness : 3/4 inch (20mm)

- When using commercial copper pipes and fittings, observe the following:
  - a) Insulation of pipes should be done after performing air tight test and vacuum drying on page 12.
  - b) Heat transfer rate: 0.041 to 0.052W/Mk (0.024 to 0.030BTU/ft·h°F (0.035 to 0.045kcal/mh°C))
  - c) Be sure to use insulation that is designed for use with HVAC Systems.
  - d) The highest temperature that the gas-side piping can reach is around 248°F(120°C), so be sure to use insulating material which is very resistant.

(The highest temperature that the gas-side piping can reach is around 248°F(120°C), so be sure to use insulating material which is very resistant.)

**CAUTION**  
For local insulation, be sure to insulate all the way to the pipe connections inside the machine. Exposed piping may cause leaking or burns on contact.

## 7-6 Example of connection

Example of connection (Connection of 8 indoor units Heat pump system)		Branch with refnet joint	Branch with refnet joint and refnet header	Branch with refnet header																																																										
		<p>Outdoor unit REFNET joint (A-G) Indoor units (1-8)</p>	<p>Outdoor unit REFNET joint (A-B) Refnet header Indoor units (1-8)</p>	<p>Outdoor unit Refnet header Indoor units (1-8)</p>																																																										
Maximum allowable height length		Pipe length between outdoor and indoor units ≤ 100ft. (30.5m), 24/36/48 type. Example unit 8: a + b + c + d + e + f + g + p ≤ 100ft. (30.5m), 24/36/48 type.		Example unit 8: a + i ≤ 100ft. (30.5m), 24/36/48 type.																																																										
Allowable height length	Between outdoor and indoor units	Equivalent pipe length between outdoor and indoor units ≤ 125ft. (38m), 24/36/48 type. (assume equivalent pipe length of refnet joint to be 1.8ft. (0.5m), that of refnet header to be 3.2ft. (1m), calculation purposes)																																																												
	Between outdoor and indoor units	Total extension length																																																												
	Between indoor and indoor units	Difference in height																																																												
Allowable length after the branch	Between indoor and indoor units	Difference in height																																																												
		Actual pipe length																																																												
<b>Refrigerant branch kit selection</b> <small>Refrigerant branch kits can only be used with R410A.</small>		Use refnet joint from the following table.	How to select the refnet header • Choose from the following table below the REFNET header according to the number of units on the system.	Use refnet header from the following table.																																																										
		<table border="1"> <thead> <tr> <th>Outdoor unit capacity type</th> <th>Refrigerant branch kit name</th> </tr> </thead> <tbody> <tr> <td>RXSQ24, 36, 48 type</td> <td>KHRP26A22T9</td> </tr> </tbody> </table>	Outdoor unit capacity type	Refrigerant branch kit name	RXSQ24, 36, 48 type	KHRP26A22T9	<table border="1"> <thead> <tr> <th>Outdoor unit capacity type</th> <th>Refrigerant branch kit name</th> </tr> </thead> <tbody> <tr> <td>RXSQ24, 36, 48 type</td> <td>KHRP26M22H9 (Max. 4 branch)</td> </tr> <tr> <td></td> <td>KHRP26M33H9 (Max. 8 branch)</td> </tr> </tbody> </table>	Outdoor unit capacity type	Refrigerant branch kit name	RXSQ24, 36, 48 type	KHRP26M22H9 (Max. 4 branch)		KHRP26M33H9 (Max. 8 branch)																																																	
Outdoor unit capacity type	Refrigerant branch kit name																																																													
RXSQ24, 36, 48 type	KHRP26A22T9																																																													
Outdoor unit capacity type	Refrigerant branch kit name																																																													
RXSQ24, 36, 48 type	KHRP26M22H9 (Max. 4 branch)																																																													
	KHRP26M33H9 (Max. 8 branch)																																																													
<b>Pipe size selection</b> <Caution on selecting connection pipes>		<p>Piping between outdoor unit and refrigerant branch kit</p> <ul style="list-style-type: none"> <li>Match to the size of the connection piping on the outdoor unit.</li> </ul> <p>Use for multi connection</p> <table border="1"> <thead> <tr> <th rowspan="2">Outdoor unit capacity type</th> <th colspan="2">Gas pipe</th> <th colspan="2">Liquid pipe</th> </tr> <tr> <th>φ5/8 (15.9mm)</th> <th>φ3/4 (19.1mm)</th> <th>φ1-1/8 (28.6mm)</th> <th>φ3/8 (9.5mm)</th> </tr> </thead> <tbody> <tr> <td>RXSQ24 type</td> <td>○</td> <td>○</td> <td>×</td> <td>○</td> </tr> <tr> <td>RXSQ36 type</td> <td>○</td> <td>○</td> <td>○</td> <td>○</td> </tr> <tr> <td>RXSQ48 type</td> <td>○</td> <td>○</td> <td>○</td> <td>○</td> </tr> </tbody> </table> <p>Use for pair connection</p> <table border="1"> <thead> <tr> <th rowspan="2">Outdoor unit capacity type</th> <th colspan="2">Gas pipe</th> <th colspan="2">Liquid pipe</th> </tr> <tr> <th>φ5/8 (15.9mm)</th> <th>φ3/4 (19.1mm)</th> <th>φ1-1/8 (28.6mm)</th> <th>φ3/8 (9.5mm)</th> </tr> </thead> <tbody> <tr> <td>RXSQ24 type</td> <td>○</td> <td>○</td> <td>×</td> <td>○</td> </tr> <tr> <td>RXSQ36 type</td> <td>○</td> <td>○</td> <td>○</td> <td>○</td> </tr> <tr> <td>RXSQ48 type</td> <td>○</td> <td>○</td> <td>○</td> <td>○</td> </tr> </tbody> </table> <p>○: Standard size ○: Available ×: Not available</p>	Outdoor unit capacity type	Gas pipe		Liquid pipe		φ5/8 (15.9mm)	φ3/4 (19.1mm)	φ1-1/8 (28.6mm)	φ3/8 (9.5mm)	RXSQ24 type	○	○	×	○	RXSQ36 type	○	○	○	○	RXSQ48 type	○	○	○	○	Outdoor unit capacity type	Gas pipe		Liquid pipe		φ5/8 (15.9mm)	φ3/4 (19.1mm)	φ1-1/8 (28.6mm)	φ3/8 (9.5mm)	RXSQ24 type	○	○	×	○	RXSQ36 type	○	○	○	○	RXSQ48 type	○	○	○	○	<p>Piping between refrigerant branch kit and indoor unit</p> <ul style="list-style-type: none"> <li>Pipe size for direct connection to indoor unit must be the same as the connection size of indoor unit.</li> </ul> <p>Indoor unit connection pipe size (Unit: in.)</p> <table border="1"> <thead> <tr> <th rowspan="2">Indoor unit capacity type</th> <th colspan="2">Piping size (outer diameter)</th> </tr> <tr> <th>Gas pipe</th> <th>Liquid pipe</th> </tr> </thead> <tbody> <tr> <td>07 - 09 - 12 - 15 18 type</td> <td>φ1-1/2" (12.7mm)</td> <td>φ1/4" (6.4mm)</td> </tr> <tr> <td>24 - 30 - 36 - 48 - 54 type</td> <td>φ5/8" (15.9mm)</td> <td>φ3/8" (9.5mm)</td> </tr> </tbody> </table>	Indoor unit capacity type	Piping size (outer diameter)		Gas pipe	Liquid pipe	07 - 09 - 12 - 15 18 type	φ1-1/2" (12.7mm)	φ1/4" (6.4mm)	24 - 30 - 36 - 48 - 54 type	φ5/8" (15.9mm)	φ3/8" (9.5mm)
Outdoor unit capacity type	Gas pipe			Liquid pipe																																																										
	φ5/8 (15.9mm)	φ3/4 (19.1mm)	φ1-1/8 (28.6mm)	φ3/8 (9.5mm)																																																										
RXSQ24 type	○	○	×	○																																																										
RXSQ36 type	○	○	○	○																																																										
RXSQ48 type	○	○	○	○																																																										
Outdoor unit capacity type	Gas pipe		Liquid pipe																																																											
	φ5/8 (15.9mm)	φ3/4 (19.1mm)	φ1-1/8 (28.6mm)	φ3/8 (9.5mm)																																																										
RXSQ24 type	○	○	×	○																																																										
RXSQ36 type	○	○	○	○																																																										
RXSQ48 type	○	○	○	○																																																										
Indoor unit capacity type	Piping size (outer diameter)																																																													
	Gas pipe	Liquid pipe																																																												
07 - 09 - 12 - 15 18 type	φ1-1/2" (12.7mm)	φ1/4" (6.4mm)																																																												
24 - 30 - 36 - 48 - 54 type	φ5/8" (15.9mm)	φ3/8" (9.5mm)																																																												
		<table border="1"> <thead> <tr> <th rowspan="2">Outdoor unit capacity type</th> <th colspan="2">Piping size (outer diameter)</th> </tr> <tr> <th>Gas pipe</th> <th>Liquid pipe</th> </tr> </thead> <tbody> <tr> <td>07 - 09 - 12 - 15 18 type</td> <td>φ1-1/2" (12.7mm)</td> <td>φ1/4" (6.4mm)</td> </tr> <tr> <td>24 - 30 - 36 - 48 - 54 type</td> <td>φ5/8" (15.9mm)</td> <td>φ3/8" (9.4mm)</td> </tr> </tbody> </table>	Outdoor unit capacity type	Piping size (outer diameter)		Gas pipe	Liquid pipe	07 - 09 - 12 - 15 18 type	φ1-1/2" (12.7mm)	φ1/4" (6.4mm)	24 - 30 - 36 - 48 - 54 type	φ5/8" (15.9mm)	φ3/8" (9.4mm)		<p>Between refrigerant branch kit and indoor unit</p> <ul style="list-style-type: none"> <li>Pipe size for direct connection to indoor unit must be the same as the connection size of indoor unit.</li> </ul> <p>Indoor unit connection pipe size (Unit: in.)</p> <table border="1"> <thead> <tr> <th rowspan="2">Indoor unit capacity type</th> <th colspan="2">Piping size (outer diameter)</th> </tr> <tr> <th>Gas pipe</th> <th>Liquid pipe</th> </tr> </thead> <tbody> <tr> <td>07 - 09 - 12 - 15 18 type</td> <td>φ1-1/2" (12.7mm)</td> <td>φ1/4" (6.4mm)</td> </tr> <tr> <td>24 - 30 - 36 - 48 - 54 type</td> <td>φ5/8" (15.9mm)</td> <td>φ3/8" (9.4mm)</td> </tr> </tbody> </table>	Indoor unit capacity type	Piping size (outer diameter)		Gas pipe	Liquid pipe	07 - 09 - 12 - 15 18 type	φ1-1/2" (12.7mm)	φ1/4" (6.4mm)	24 - 30 - 36 - 48 - 54 type	φ5/8" (15.9mm)	φ3/8" (9.4mm)																																				
Outdoor unit capacity type	Piping size (outer diameter)																																																													
	Gas pipe	Liquid pipe																																																												
07 - 09 - 12 - 15 18 type	φ1-1/2" (12.7mm)	φ1/4" (6.4mm)																																																												
24 - 30 - 36 - 48 - 54 type	φ5/8" (15.9mm)	φ3/8" (9.4mm)																																																												
Indoor unit capacity type	Piping size (outer diameter)																																																													
	Gas pipe	Liquid pipe																																																												
07 - 09 - 12 - 15 18 type	φ1-1/2" (12.7mm)	φ1/4" (6.4mm)																																																												
24 - 30 - 36 - 48 - 54 type	φ5/8" (15.9mm)	φ3/8" (9.4mm)																																																												
		<table border="1"> <thead> <tr> <th rowspan="2">CXTQ**</th> <th colspan="2">Usable existing gas pipe</th> </tr> <tr> <th>φ3/4" (19.1mm)</th> <th>φ7/8" (22.2mm)</th> </tr> </thead> <tbody> <tr> <td>24 type</td> <td>○</td> <td>○</td> </tr> <tr> <td>36 type</td> <td>○</td> <td>○</td> </tr> <tr> <td>48 type</td> <td>○</td> <td>○</td> </tr> <tr> <td>60 type</td> <td>○</td> <td>○</td> </tr> </tbody> </table>	CXTQ**	Usable existing gas pipe		φ3/4" (19.1mm)	φ7/8" (22.2mm)	24 type	○	○	36 type	○	○	48 type	○	○	60 type	○	○																																											
CXTQ**	Usable existing gas pipe																																																													
	φ3/4" (19.1mm)	φ7/8" (22.2mm)																																																												
24 type	○	○																																																												
36 type	○	○																																																												
48 type	○	○																																																												
60 type	○	○																																																												

# 7-7 Additional refrigerant charge amount

## ■ Additional refrigerant charge amount

※ Put connected indoor unit Qty based on table below.

< Indoor unit type

Ducted	FXSQ**	FXMQ**	FXMQ**	Unit number (Qty)	Sub total (lbs)
G1	07,09,12,15	-	-	0.27 x	
G2	18,24,30,36	15,18,24,30,36		0.35 x	
Total					

Thermal insulation on liquid line



※ If the calculation result of the additional refrigerant amount is negative, Additional charge amount = 0 (lbs)

No - thermal insulation on liquid line

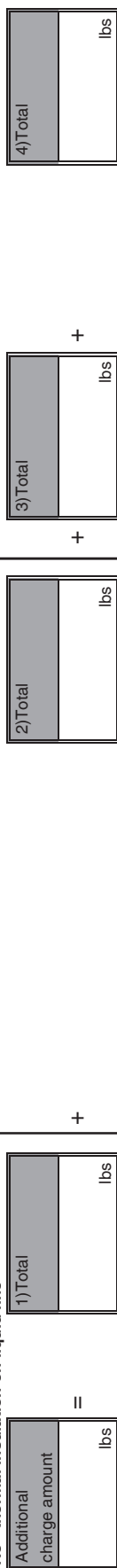

1) Liquid Refrigerant amount for field piping		Main Gas Refrigerant amount for field piping	
Liquid Pipe size	Refrigerant amount (lbs/ft)	Main Gas Pipe size	Refrigerant amount (lbs/ft)
3/8"	0.036 x	1-1/8"	N/A
1/4"	0.015 x	7/8"	N/A
		3/4"	0.004
		5/8"	0
Total		Total	

2) Main Gas Refrigerant amount for field piping		Main Gas Refrigerant amount for field piping	
Main Gas Pipe size	Refrigerant amount (lbs/ft)	Main Gas Pipe Length (ft)	Sub total (lbs)
1-1/8"	N/A	60	
7/8"	N/A	0.015	
3/4"	0.008	0.005	
5/8"	0.004	0	
	0	N/A	
Total		Total	

3) ODU Capacity		Sub total	
Model name RXSQ**T	Sub total (lbs)	Model name RXSQ**T	Sub total (lbs)
60	0.34	Either	
24,36,48	0		
Total		Total	

4) Indoor unit type		Sub total	
Refrigerant amount (lbs)	Unit number	Refrigerant amount (lbs)	Unit number
G1	0.47 x		
G2	0.57 x		
G3	0.75 x		
G4	0.97 x		
G5	1.08 x		
G6	1.26 x		
G7	1.46 x		
G8	1.62 x		
G9	1.83 x		
G10	1.94 x		
G11	2.49 x		
G12	3.44 x		
G13	3.75 x		
G14	4.78 x		
Total		Total	

Model name RXSQ**T	
24,36	48
2.40	3.19
Total	

[A]-[B]  
[A]-[B]<0, Put "0"

※ Put connected indoor unit Qty based on table below.

< Indoor unit type table >

	Ducted				Non-ducted				A-coil	
	FXSQ**	FXMQ**	FXDQ**	FXNQ**	FXLQ**	FXUQ**	FXAQ**	FXHQ**	FXUQ**	CXTQ**
G1	07-15	-	-	-	-	-	-	-	-	-
G2	-	-	07,09,12	07	07	-	07,09,12	-	-	-
G3	18,24	15,18	18	-	09,12	-	15	18,24	-	-
G4	-	-	-	09,12	-	07-12	18,24	-	-	-
G5	30,36	24,36,48	-	-	-	15-36	-	-	-	-
G6	-	-	24	-	-	-	-	-	-	-
G7	-	-	-	18,24	18	-	-	18,24	-	24
G8	48	48	-	-	-	-	-	-	-	-
G9	54	54	-	-	-	-	-	-	-	-
G10	-	-	-	-	24	-	-	-	-	-
G11	-	-	-	-	30,36	-	-	-	-	36
G12	-	-	-	-	42,48	-	-	-	-	-
G13	-	72	-	-	-	-	-	-	-	48
G14	-	-	-	-	54,60	-	-	-	-	60

## 7-8 Air tight test and vacuum drying

After doing the piping, perform the following inspections.

### Air tight test

Be sure to use nitrogen gas. (See the figure (“Stop valve operation procedure”) for the location of the service port.)

[Procedure]

Pressurize from the liquid pipes and gas pipes to 550psi(3.8MPa) (and not above 550psi(3.8MPa)). If there is not pressure drop over the next 24 hours, the equipment has passed the test.

If the pressure drops, check for leakage positions. (Confirm that there is no leakage, then release nitrogen.)

If a FXTQ indoor unit and a CXTQ unit are used, only pressurize to 450psi(3.1MPa).

### Vacuum drying

Use a vacuum pump that can create a vacuum down to at least 500 microns.

[Procedure]

Operate the vacuum pump for **at least 2 hours** from **both the liquid and gas pipes** and decrease the pressure to at least 500 microns.

Leave at below 500 microns for at least 1 hour and make sure that the vacuum gauge does not rise. (If it does rise, there is either still moisture in the system or a leak.)

**Cases where moisture might enter the piping** (i.e., if doing work during the rainy season, if the actual work takes long enough that condensation may form on the inside of the pipes, if rain might enter the pipes during work, etc.)

After performing the vacuum drying for 2 hours, pressurize to 7.2psi(0.05MPa) (i.e., vacuum breakdown) with nitrogen gas, then depressurize down to at least 500 microns a for an hour using the vacuum pump (vacuum drying). (If the pressure does not reach at least 500 microns even after depressurizing for at least 2 hours, repeat the vacuum breakdown - vacuum drying process.) Leave as a vacuum for 1 hour after that, and make sure the vacuum gauge does not rise.

(Refer to figure 27)

1. Decompression valve
2. Nitrogen
3. Vacuum pump
4. Valve (Open)
5. Charge hose
6. Stop valve service port
7. Indoor unit
8. Gas line stop valve (Close)
9. Liquid line stop valve (Close)
10. Indicates local procurement
11. Outdoor unit

### NOTE

The stop valve must always be turned to “closed”. Otherwise the refrigerant in the outdoor unit will pour out.

### Stop valve operation procedure

#### Precautions when handling the stop valve

- The names of parts needed to operate the stop valve are shown in the figure below. The unit is shipped from the factory with the stop valve turned to the “closed” position.

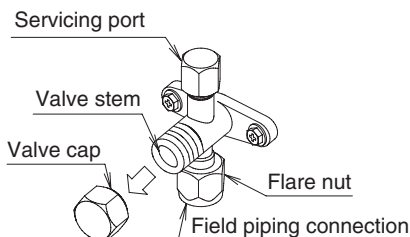

- Since the side boards may be deformed if only a torque wrench is used when loosening or tightening flare nuts, always lock the stop valve with a wrench and then use a torque wrench.
- In cases where the unit is run in heating mode when the outside temperature is low or in other situations where the operating pressure might drop, seal the gas-side flare nut on the stop valve with silicon sealant or the like to prevent it from freezing.

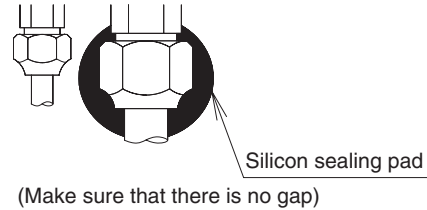

### Stop valve operation procedure

Have a hex wrench ready (size: 0.2in.(4mm) and 0.3in.(6mm)).

#### Opening the valve

1. Place the hex wrench on the valve stem and turn counter-clockwise.
2. Stop when the valve stem no longer turns. It is now open.

#### Close the valve

1. Place the hex wrench on the valve stem and turn clockwise.
2. Stop when the valve stem no longer turns. It is now closed.

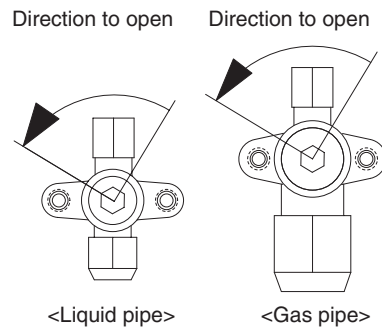

### Precautions for handling valve cap

- A seal is attached to the point indicated by the arrow. Take care not to damage it.

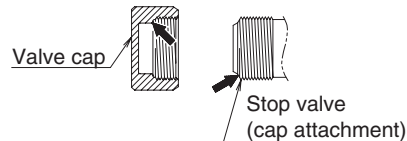

- Be sure to tighten the valve cap securely after operating the valves.

Liquid-side tightening torque	Gas-side tightening torque
10.0 ~ 12.2 ft.lbf	16.6 ~ 20.3 ft.lbf
13.5 ~ 16.5 N·m	22.5 ~ 27.5 N·m

### Precautions for handling servicing port

- Use a push-rod-provided charging hose for operation.
- Be sure to tighten the valve cap securely after operation. Tightening torque.....8.5 ~ 10.3 ft.lbf (10.8 ~ 14.7 N·m)



## 8. ADDITIONAL REFRIGERANT CHARGE

### ⚠ WARNING

- When leaving the unit with the power on, be sure to switch with another person doing the installation or close the front panel.



### 8-1 Before adding refrigerant

- Make sure the following work and inspection is complete, in accordance with the installation manual.
  - Piping
  - Wiring
  - Airtightness test, Vacuum drying

### 8-3 Adding refrigerant

#### Filling after calculating the amount of refrigerant to add

- Calculate the amount of refrigerant to add as described in "Calculating the amount of refrigerant to add" in "7. PRECAUTIONS ON REFRIGERANT PIPING".
- After the vacuum drying is finished, open valve A and charge the calculated amount of refrigerant through the service port for the liquid-side stop valve.
- Close valve A after charging is complete.

Note: If all the refrigerant to be added cannot be charged using the above procedure, right-hand the procedure below and re-charge the refrigerant.

#### If all the refrigerant could not be added

Add refrigerant using the following procedure. See the "Service Precautions" plate attached to the outdoor unit for details on the settings for adding refrigerant.

## 9. POST-WORK CHECKS

Perform the following checks after work is complete.

- Drain pipe connection, removal of transport clasp → See "5. PRECAUTIONS ON INSTALLATION".
- Incorrect power supply wiring, loose screws → See "6-3 How to connect the power supply wiring".
- Incorrect transmission wiring, loose screws → See "6-4 Transmission wiring connection procedure".
- Incorrect refrigerant piping connections → See "7. PRECAUTIONS ON REFRIGERANT PIPING".
- Piping sizes, use of insulation → See : "7-1 Selecting piping material".  
"7-5 Heat insulation of piping".
- Stop valve check → Make sure both the liquid-side and gas-side stop valves are open.
- Record of Amount of Refrigerant Added → Record it on "Record of Amount of Refrigerant Added" on the "Service Precautions" plate.
- Measuring the insulation of the main power circuit →
  - Use a 500V mega-tester.
  - Do not use the mega-tester for weak currents other than 208/230V. (Transmission wiring)

### ⚠ CAUTION

#### To the pipe-layer

After completing installation, be sure to open the valve. (Operating the unit with the valve shut will break the compressor.)

## 8-2 Checking the refrigerant tank

- Check whether the tank has a siphon pipe before charging and place the tank so that the refrigerant is charged in liquid form. (See the figure below.)

#### Tank with siphon pipe

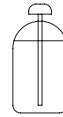

There is a siphon pipe inside, so the cylinder need not be upside-down to fill with liquid. (Stand the cylinder upright when filling.)

#### Other tanks



Stand the tank upside down and charge.

#### Status of the stop valve and other valves when adding refrigerant

- See "Stop valve operation procedure" in "7. PRECAUTIONS ON REFRIGERANT PIPING" for details on how to use the stop valve.

#### (Refer to figure 28)

- |                               |                            |
|-------------------------------|----------------------------|
| 1. R410A Tank (Siphon system) | 5. Stop valve service port |
| 2. Measuring instrument       | 6. Gas line stop valve     |
| 3. Valve A                    | 7. Outdoor unit            |
| 4. Indoor unit                | 8. Liquid line stop valve  |

State of valve A and the stop valve	Valve A	Liquid line stop valve	Gas line stop valve
Before starting to charge the refrigerant	Close	Close	Close
During charging of the refrigerant	Open	Close	Close

## 10. TEST RUN

This unit is equipped with a crank case heater to ensure smooth startup. Be sure to turn the power on at least 6 hours before operation in order to have power running to the crank case heater.

### ⚠ WARNING

When leaving the unit with the power on, be sure to switch with another person doing the installation or close the front panel.



#### Precautions before turning the power on

- Using insulating sheets, tape electric parts as described in the "Service Precautions" plate on the back of the front panel.
- All indoor units connected to the outdoor unit operate automatically. Complete work on the indoor units in order to ensure maximum safety.

#### 10-1 Power On–Check Operation

- Make sure to perform the check operation after installation. (If the air conditioner is operated using the indoor remote controller without performing the check operation, the malfunction code "U3" is displayed in the indoor remote controller, and normal operation is disabled.)
- When making settings on the outdoor unit PC board (A1P or A2P) after turning the power on, do not touch anything other than the push-button switches and dip switches. (See the "Service Precautions" plate for the locations of the push-button switches (BS1-5) and dip switches (DS1-1, 2) on the PC board (A1P or A2P).)

- During the operation, monitor the outdoor unit operation status and check for any incorrect wiring.

1. Close the outdoor unit's front panel. <b>Turn the power on</b> for the outdoor unit and the indoor unit.	<b>Caution</b> Be sure to turn the power on at least 6 hours before operation in order to have power running to the crank case heater.																										
2. • Open the outdoor unit's front panel. • Make sure the LED display on the outdoor unit's PC boards (A1P or A2P) are as shown in the following chart.																											
<24-36 type>	<table border="1"> <tr> <td></td> <td colspan="3">A1P</td> <td colspan="4">A2P</td> </tr> <tr> <td>LED display (Default status before delivery)</td> <td>HAP</td> <td>H1P</td> <td>H2P</td> <td>H3P</td> <td>H4P</td> <td>H5P</td> <td>H6P</td> <td>H7P</td> </tr> <tr> <td></td> <td>☾</td> <td>●</td> <td>●</td> <td>☀</td> <td>●</td> <td>●</td> <td>●</td> <td>●</td> </tr> </table>		A1P			A2P				LED display (Default status before delivery)	HAP	H1P	H2P	H3P	H4P	H5P	H6P	H7P		☾	●	●	☀	●	●	●	●
	A1P			A2P																							
LED display (Default status before delivery)	HAP	H1P	H2P	H3P	H4P	H5P	H6P	H7P																			
	☾	●	●	☀	●	●	●	●																			
<48 type>	<table border="1"> <tr> <td></td> <td colspan="7">A1P</td> </tr> <tr> <td>LED display (Default status before delivery)</td> <td>HAP</td> <td>H1P</td> <td>H2P</td> <td>H3P</td> <td>H4P</td> <td>H5P</td> <td>H6P</td> <td>H7P</td> </tr> <tr> <td></td> <td>☾</td> <td>●</td> <td>●</td> <td>☀</td> <td>●</td> <td>●</td> <td>●</td> <td>●</td> </tr> </table>		A1P							LED display (Default status before delivery)	HAP	H1P	H2P	H3P	H4P	H5P	H6P	H7P		☾	●	●	☀	●	●	●	●
	A1P																										
LED display (Default status before delivery)	HAP	H1P	H2P	H3P	H4P	H5P	H6P	H7P																			
	☾	●	●	☀	●	●	●	●																			
LED display: ● OFF ☀ ON ☾ Blinking																											
<b>!</b> To avoid the risk of electric shock, do not touch anything other than the push-button switches on the PC board (A1P or A2P) when making settings.																											
3. • When the customer requests quiet operation or demand operation, make these settings using the push-button switches (BS1-5) on the outdoor unit's PC board (A1P or A2P). • Operate the push-button switches through the opening after protecting it with an insulation cover. (See the "Service Precautions" plate for details.)	<b>!</b> Use caution to avoid electric shock while working, since the outdoor unit is on. • Only set the push-button switches (BS1-5) after making sure the microcomputer OK monitor is lit up. • See the "Service Precautions" plate on the front panel of the outdoor unit for details on how to make the settings. (Do not forget to write the settings down on the "Service Precautions" plate.) • The dip switch (DS1-1) does not need to be set, so do not touch it. Doing so may cause malfunction.																										
4. • Check that the liquid and gas-side stop valves are open, and if they are closed, open them.	<b>Caution</b> Do not leave any stop valve closed otherwise the compressor will fail.																										
5. Press the test run button (BS4) for at least five seconds and perform check operation. For details, see "How to perform check operation" on the "Service Precautions" plate.	• If you have to leave the outdoor unit during check operation, either switch with another worker or close the front panel. • The system operates for about 30 minutes (60 minutes at maximum) and automatically stops the check operation. • The system can start normal operation about 3 minutes <b>after the check operation</b> if the remote controller does not display any error code. The remote controller will show the test run display during check operation.																										
6. Close the front panel of the outdoor unit after check operation is complete.																											

#### <Precautions During Check Operation>

- **If operation is performed within 12 minutes of the indoor and outdoor units being turned on, H2P will light up, and the compressor will not run.**  
Only perform operation after checking that the LED display is as shown in "10-1 Power On—Check Operation" 2. table.
- In order to ensure uniform refrigerant distribution, it may take up to around 10 minutes for the compressor to start up after the unit begins running. This is not a malfunction.
- Each indoor unit cannot be checked individually for problems. After this operation is complete, run the unit normally using the remote controller.
- The check run cannot be performed in recovery or other modes.
- If the outlet pipe thermistor (R2T), the intake pipe thermistor (R3T), and the pressure sensors (S1NPH and S1NPL) are removed before operation, the compressor might burn out, so avoid this under all circumstances.

## 10-2 Temperature control operation checklist

[Set the master unit (the indoor unit with rights of selection cooling or heating)]

#### <With a wired remote controller>

- After check operation is complete, displays of all the connected remote controllers will flash "Switching mode".
- Ask the customer which indoor unit to set as the master unit. (Setting the most frequently used indoor unit as the master unit is recommended.)
- Press the mode-switch button on the remote controller for the master unit.
- That remote controller will then become the remote controller for switching between cooling and heating.
- All other remote controllers will display "Switching mode".

#### <With wireless remote controller>

- After check operation is complete, the timer lamps on all the indoor units which are connected will flash.
- Ask the customer which indoor unit to set as the master unit. (Setting the most frequently used indoor unit as the parent unit is recommended.)
- Press the mode-switch button on the remote controller for the master unit.  
A beeping sound will be emitted and the timer lamps on all the indoor units will go off.
- That indoor unit will be the indoor unit which has the right to switch between cooling and heating.  
For details, see the operation manual which comes with the unit.
- After check operation is complete, checking the temperature control using normal operation.  
(Heating is not possible if the outdoor temperature is 75°F(24°C) or higher. See the included operation manual.)
  - (1) Make sure the indoor and outdoor units are operating normally. (If liquid compression by the compressor or other abnormal noises can be heard, stop the unit immediately, heat the crank case for a sufficient amount of time, and try again.)
  - (2) Run each indoor unit one at a time and make sure the corresponding outdoor unit is also running.
  - (3) Check to see if cold (or hot) air is coming out of the indoor unit.
  - (4) Press the fan direction and fan strength buttons on the indoor unit to see if they operate properly.

#### <Precautions during temperature control checks>

- For around 5 minutes after the compressor stops, the compressor will not run even if the "operate/stop" button on the remote controller is pressed.
- When the system operation is stopped by the remote controller, the outdoor units may continue operating for further 1 minutes at maximum.
- Malfunction code "U3" is displayed if check operation is not performed using the test run button the first time after installation. Perform the check operation in accordance with "10-1 Power On—Check Operation".

#### [Remote controller displays malfunction code]

(Check on a remote controller connected to the indoor unit.)

Malfunction code	Installation error	Remedial action
E3	The stop valve of an outdoor unit is left closed.	Open the gas-side stop valve and the liquid-side stop valve.
	Refrigerant overcharge.	Recalculate the required amount of refrigerant from the piping length and correct the refrigerant charge level by recovering any excessive refrigerant with a refrigerant recovery machine.
F6	Refrigerant overcharge.	Recalculate the required amount of refrigerant from the piping length and correct the refrigerant charge level by recovering any excessive refrigerant with a refrigerant recovery machine.

E4	The stop valve of an outdoor unit is left closed.	Open the gas-side stop valve and the liquid-side stop valve.
	Insufficient refrigerant.	Check if the additional refrigerant charge has been finished correctly. Recalculate the required amount of refrigerant from the piping length and add an adequate amount of refrigerant.
F3	Refrigerant overcharge.	Recalculate the required amount of refrigerant from the piping length and correct the refrigerant charge level by recovering any excessive refrigerant with a refrigerant recovery machine.
	The stop valve of an outdoor unit is left closed.	Open the gas-side stop valve and the liquid-side stop valve.
	Insufficient refrigerant.	Check if the additional refrigerant charge has been finished correctly. Recalculate the required amount of refrigerant from the piping length and add an adequate amount of refrigerant.
U2	Insufficient supply voltage	Check to see if the supply voltage is supplied properly.
U3	If a check operation has not been performed.	Perform a check operation.
U4	No power is supplied to an outdoor unit.	Turn the power on for the outdoor unit.
UA	If no dedicated indoor unit is being used.	Check the indoor unit. If it is not a dedicated unit, replace the indoor unit.
UF	The stop valve of an outdoor unit is left closed.	Open the gas-side stop valve and the liquid-side stop valve.
	If the right indoor unit piping and wiring are not properly connected to the outdoor unit.	Make sure that the right indoor unit piping and wiring are properly connected to the outdoor unit.
UH	If the transmission wiring has not been connected or it has shorted.	Make sure the transmission wiring is correctly attached to terminals (X2M) F1/F2 (TO IN/D UNIT) on the outdoor unit circuit board.

- When using a central controller, see the installation manual or service manual which came with the central controller.

**[If nothing is displayed on the remote controller]**

- There might be a problem with the connections or communication between the indoor unit and the remote controller. Make sure all the wiring is properly connected.



**CAUTION**

**To the pipe-layer, To the electrician**

After the test run, when handing the unit over to the customer, make sure the front panel on the unit and all screws are attached.

### 10-3 Final refrigerant charge adjustment

It is not necessary to do this final adjustment normally, but perform the following operation only when the most adequate refrigerant charge for the best performance is required and the piping length between the outdoor and indoor units is less than 50ft. (15m).  
The outdoor temperature must be between 65°F and 105°F.

The number of revolutions of the compressor must be greater than or equal to the charge mode. (It can be confirmed by LED display on printed circuit board)

The number of revolutions of the compressor LED display.  
(○●●●●●○:Chargeable ○●●●●●●:Impossible to charge)

In the case of multiple connection with an indoor unit other than CXTQ + G / F, the receiver vessel (Optional item) is not attached to the liquid piping.

Run the system for 60 minutes in cooling by the forced operation using the field setting mode 2, No.20 LED ○●:ON, mode 2, No.7 LED ○●:ON, (Refer to Service Manual.) to allow pressures to stabilize.

Check subcooling of outdoor unit at LSV. Systems should have the target subcooling in the table below.

- If the subcooling is low, add charge to raise subcooling to the target value. (The maximum additional charge is 2.2 lbs.(1kg))
- If the subcooling is high, remove charge to lower the subcooling to the target value.

Model	Target subcooling
RXSQ24~	6±1°F (3.33±0.56°C)
RXSQ36~	2±1°F (1.11±0.56°C)
RXSQ48~	12±1°F (6.67±0.56°C)

However, refer to the table below for pair connection with CXTQ.

Model	Target subcooling
RXSQ24+CXTQ24	5±1°F (2.78±0.56°C)
RXSQ36+CXTQ36	8±1°F (4.44±0.56°C)
RXSQ48+CXTQ48	13±1°F (7.22±0.56°C)

If all connected indoor units are a combination of FXSQ or FXMQ, refer to the table below.

Model	Target subcooling
RXSQ24+FXSQ, FXMQ	5±1°F (2.78±0.56°C)
RXSQ36+FXSQ, FXMQ	4±1°F (2.72±0.56°C)
RXSQ48+FXSQ, FXMQ	11±1°F (6.11±0.56°C)

## 11. ENERGY SAVING AND OPTIMUM OPERATION

RXSQ~ units are equipped with advanced energy saving functionality. Depending on the priority, emphasis can be put on energy saving or comfort level. Several parameters can be selected, resulting in the optimal balance between energy consumption and comfort for the particular application.

Several patterns are available and explained below. Modify the parameters to the needs of your building and to realize the best balance between energy consumption and comfort.

Refer to Service Manual for changing the field settings.

Setting definition:[A-B]=C;A=mode,B=setting NO.,C=setting value.

### 11-1 Three main operation methods are available:

• **Basic**

The refrigerant temperature is fixed independent from the situation. It corresponds to the standard operation which is known and can be expected from/under previous VRV systems:

- To activate this operation method under cooling operation: change field setting [2-8]=2.
- To activate this operation method under heating operation: change field setting [2-9]=2.

• **Automatic(default)**

The refrigerant temperature is set depending on the outdoor ambient conditions. As such adjusting the refrigerant temperature to match the required load (which is also related to the outdoor ambient conditions). E.g., when your system is operating in cooling, you do not need as much cooling under low outdoor ambient temperatures (e.g., 77°F(25°C)) as under high outdoor ambient temperatures (e.g., 95°F(35°C)). Using this idea, the system automatically starts increasing its refrigerant temperature, automatically reducing the delivered capacity and increasing the system's efficiency.

- To activate this operation method under cooling operation: change field setting [2-8]=3(default).

E.g., when your system is operating in heating, you do not need as much heating under high outdoor ambient temperatures (e.g., 59°F(15°C)) as under low outdoor ambient temperatures (e.g., 23°F (-5°C)).

Using this idea, the system automatically starts decreasing its refrigerant temperature, automatically reducing the delivered capacity and increasing the system's efficiency.

- To activate this operation method under heating operation: change field setting [2-9]=1 (default).

**Hi-sensible (cooling)**

The refrigerant temperature is set higher (cooling) compared to basic operation. The focus under high sensible mode is improved comfort for the customer.

The selection method of indoor units is important and has to be considered as the available capacity is not the same as under basic operation. For details concerning to Hi-sensible applications, please contact your dealer.

- To activate this setting under cooling operation: change field setting [2-8] to the appropriate value, matching the requirements of the pre-designed system containing a high sensible solution.

Value	To target
4	46°F(8°C)
5	48°F(9°C)
6	50°F(10°C)
7	52°F(11°C)

**11-2 Several comfort settings are available**

For each of above modes a comfort level can be selected. The comfort level is related to the timing and the effort (energy consumption) which is put in achieving a certain room temperature by temporarily changing the refrigerant temperature to different values in order to achieve requested conditions more quickly.

**Powerful**

Overshoot (during heating operation) or undershoot (during cooling operation) is allowed compared to the requested refrigerant temperature, in order to achieve the required room temperature very fast. The overshoot is allowed from the start up moment.

In case of cooling operation the evaporating temperature is allowed to go down to 37°F (3°C) on temporary base depending on the situation.

In case of heating operation the condense temperature is allowed to go up to 120°F (49°C) on temporary base depending on the situation. When the request from the indoor units becomes more moderate, the system will eventually go to the steady state condition which is defined by the operation method above.

- To activate the powerful comfort setting under cooling operation, change field setting [2-41]=3.

This setting is used in conjunction with setting [2-8].

- To activate the powerful comfort setting under heating operation, change field setting [2-42]=3.

This setting is used in conjunction with setting [2-9].

**Quick**

Overshoot (during heating operation) or undershoot (during cooling operation) is allowed compared to the requested refrigerant temperature, in order to achieve the required room temperature very fast. The overshoot is allowed from the start up moment.

In case of cooling operation the evaporating temperature is allowed to go down to 43°F (6°C) on temporary base depending on the situation.

In case of heating operation the condense temperature is allowed to go up to 115°F (46°C) on temporary base depending on the situation. When the request from the indoor units becomes more moderate, the system will eventually go to the steady state condition which is defined by the operation method above.

- To activate the quick comfort setting under cooling operation, change field setting [2-41]=2.

This setting is used in conjunction with setting [2-8].

- To activate the quick comfort setting under heating operation, change field setting [2-42]=2.

This setting is used in conjunction with setting [2-9].

**Mild**

Overshoot (during heating operation) or undershoot (during cooling operation) is allowed compared to the requested refrigerant temperature, in order to achieve the required room temperature very fast. The overshoot is not allowed from the start up moment. The start up occurs under the condition which is defined by the operation mode above.

In case of cooling operation the evaporating temperature is allowed to go down to 43°F (6°C) on temporary base depending on the situation.

In case of heating operation the condense temperature is allowed to go up to 115°F (46°C) on temporary base depending on the situation.

When the request from the indoor units becomes more moderate, the system will eventually go to the steady state condition which is defined by the operation method above.

The start up condition is different from the powerful and quick comfort setting.

- To activate the mild comfort setting under cooling operation, change field setting [2-41]=1.

This setting is used in conjunction with setting [2-8].

- To activate the mild comfort setting under heating operation, change field setting [2-42]=1.

This setting is used in conjunction with setting [2-9].

**Eco**

The original refrigerant temperature target, which is defined by the operation method (see above) is kept without any correction, unless for protection control.

- To activate the mild comfort setting under cooling operation, change field setting [2-41]=0.

This setting is used in conjunction with setting [2-8].

- To activate the mild comfort setting under heating operation, change field setting [2-42]=0.

This setting is used in conjunction with setting [2-9].

**11-3 Switch over ambient setting**

When the gas furnace is connected, it can be set so that gas furnace operation can be switched at the outside air temperature.

The switching temperature can be set in service mode 2-14. Also, in order to prevent frequent switching, a differential of the outside air temperature is provided (2-15 # 1ΔT = 10°F (5.6°C)).

The factory setting is 2-14 # 6 → 15°F(-9.4°C)

Setting #	#	0	1	2	3	4	5	6	7	8	9	10	11	12	13	14	15
Page 2-14	Switch over Temp.	°C	-20.5	-17.7	-15	-12.2	<u>-9.4</u>	-6.6	-3.8	-1.1	1.6	4.4	7.2	10	100	-100	
		°F	-5	0	5	10	<u>15</u>	20	25	30	35	40	45	50	212	-148	

Setting #	#	0	1	2	
Page 2-15	Switch over differential Temp. ΔT	°C	2.8	<u>5.6</u>	8.3
		°F	5	10	15

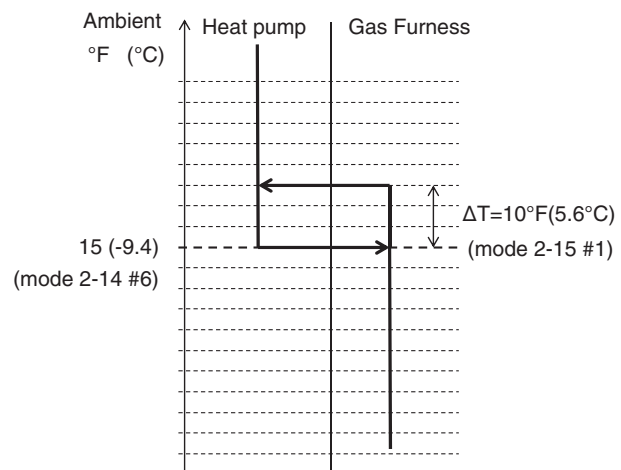

### 11-4 Setting of Heat Pump Lockout and Emergency Heat Mode

Heat pump is locked out when the setting below and/or external input to ABC terminal has been made.

No.	Setting item display								Setting condition display								
	Setting item	MODE H1P	TEST H2P	C/H selection			Low noise H6P	Demand H7P									
				IND H3P	Master H4P	Slave H5P											
16	Setting of heat pump lockout 1	<input type="radio"/>	<input checked="" type="radio"/>	<input type="radio"/>	<input checked="" type="radio"/>	<input checked="" type="radio"/>	<input checked="" type="radio"/>	<input checked="" type="radio"/>	OFF	<input type="radio"/>	<input checked="" type="radio"/>	<input checked="" type="radio"/>	<input checked="" type="radio"/>	<input checked="" type="radio"/>	<input checked="" type="radio"/>	<input type="radio"/>	*
									ON	<input type="radio"/>	<input checked="" type="radio"/>	<input checked="" type="radio"/>	<input checked="" type="radio"/>	<input checked="" type="radio"/>	<input type="radio"/>	<input checked="" type="radio"/>	
37	Setting of heat pump lockout 2	<input type="radio"/>	<input type="radio"/>	<input checked="" type="radio"/>	<input checked="" type="radio"/>	<input type="radio"/>	<input checked="" type="radio"/>	<input type="radio"/>	OFF	<input type="radio"/>	<input checked="" type="radio"/>	<input checked="" type="radio"/>	<input checked="" type="radio"/>	<input checked="" type="radio"/>	<input checked="" type="radio"/>	<input checked="" type="radio"/>	*
									Mode 1	<input type="radio"/>	<input checked="" type="radio"/>	<input checked="" type="radio"/>	<input checked="" type="radio"/>	<input checked="" type="radio"/>	<input checked="" type="radio"/>	<input type="radio"/>	
									Mode 2	<input type="radio"/>	<input checked="" type="radio"/>	<input checked="" type="radio"/>	<input checked="" type="radio"/>	<input checked="" type="radio"/>	<input type="radio"/>	<input checked="" type="radio"/>	
									Mode 3	<input type="radio"/>	<input checked="" type="radio"/>	<input checked="" type="radio"/>	<input checked="" type="radio"/>	<input checked="" type="radio"/>	<input type="radio"/>	<input type="radio"/>	
									Mode 4	<input type="radio"/>	<input checked="" type="radio"/>	<input checked="" type="radio"/>	<input checked="" type="radio"/>	<input type="radio"/>	<input checked="" type="radio"/>	<input checked="" type="radio"/>	
									Mode 5	<input type="radio"/>	<input checked="" type="radio"/>	<input checked="" type="radio"/>	<input checked="" type="radio"/>	<input type="radio"/>	<input checked="" type="radio"/>	<input type="radio"/>	
									Mode 6	<input type="radio"/>	<input checked="" type="radio"/>	<input checked="" type="radio"/>	<input checked="" type="radio"/>	<input type="radio"/>	<input type="radio"/>	<input checked="" type="radio"/>	

Type	Description	Actions						
		Field setting	Shorted between	Heating Thermo-on		Heating Thermo-off		
				Heater	Fan	Heater	Fan	
I	–	Heat-pump heating is always locked out	2-16: ON	–	ON	ON (H/L)	OFF	LL
II	Mode 1	Lockout is controlled by ABC terminals	2-37: Mode 1	A-C	ON	ON (H/L)	OFF	LL
	B-C			OFF				
	Mode 2 (for a heater which does not need airflow)		2-37: Mode 2	A-C		LL		LL
				B-C		OFF		OFF
	Mode 3	Lockout is controlled by the outdoor ambient temperature and setpoint which is configured by the field setting 2-57 and 2-47	2-37: Mode 3	Same as 2-37: Mode 1, A-C shorted				
	Mode 4	2-37: Mode 4	Same as 2-37: Mode 1, B-C shorted					
	Mode 5	2-37: Mode 5	Same as 2-37: Mode 2, A-C shorted					
	Mode 6	2-37: Mode 6	Same as 2-37: Mode 2, B-C shorted					

**Heat pump lockout temperature**

Heat pump would be locked out when the outdoor ambient temperature is smaller than the heat pump lockout temperature.

This setting is only effective when heat pump lockout mode has been set.

When connecting with multiple G/Fs, should make the following settings.

And should make the field setting of indoor. About indoor setting, see indoor installation manual.

No.	Setting item display								Setting condition display								
	Setting item	MODE H1P	TEST H2P	C/H selection			Low noise H6P	Demand H7P									
				IND H3P	Master H4P	Slave H5P											
57	Heat pump lockout temperature	○	○	○	○	●	●	○	*Factory setting								
									-26.1°C (-15°F)	○	●	●	●	●	●	●	*
									-23.3°C (-10°F)	○	●	●	●	●	●	○	
									-20.5°C (-5°F)	○	●	●	●	●	○	●	
									-17.7°C (0°F)	○	●	●	●	●	○	○	
									-15°C (5°F)	○	●	●	●	○	●	●	
									-12.2°C (10°F)	○	●	●	●	○	●	○	
									-9.4°C (15°F)	○	●	●	●	○	○	●	
									-6.6°C (20°F)	○	●	●	●	○	○	○	
									-3.8°C (25°F)	○	●	●	○	●	●	●	
									-1.1°C (30°F)	○	●	●	○	●	●	○	
									1.6°C (35°F)	○	●	●	○	●	○	●	
									4.4°C (40°F)	○	●	●	○	●	○	○	
									7.2°C (45°F)	○	●	●	○	○	●	●	
10°C (50°F)	○	●	●	○	○	●	○										
Forced heat pump lockout	○	●	●	○	○	○	●										

**Heat pump lockout release differential**

Heat pump would be resumed when the outdoor ambient temperature is recovered by differential above the heat pump lockout temperature.

No.	Setting item display								Setting condition display								
	Setting item	MODE H1P	TEST H2P	C/H selection			Low noise H6P	Demand H7P									
				IND H3P	Master H4P	Slave H5P											
47	Heat pump lockout release differential	○	○	●	○	○	○	○	*Factory setting								
									2.8°C (5°F)	○	●	●	●	●	●	●	
									5.6°C (10°F)	○	●	●	●	●	●	○	*
									8.3°C (15°F)	○	●	●	●	●	○	●	

**Automatic lockout**

When heat pump lockout mode has been set, the auto backup function will automatically be set. This will allow the auxiliary or secondary heat source to be automatically energized in the event of a system failure related to outdoor units.

### 11-5 Setting of larger pipe connection and no insulation on liquid line

When using existing piping, make the following settings.

No.	Setting item display								Setting condition display
	Setting item	MODE H1P	TEST H2P	C/H selection			Low noise H6P	Demand H7P	
				IND H3P	Master H4P	Slave H5P			
4	Existing pipe connection	<input type="radio"/>	<input checked="" type="radio"/>	<input checked="" type="radio"/>	<input checked="" type="radio"/>	<input type="radio"/>	<input checked="" type="radio"/>	<input checked="" type="radio"/>	<p style="text-align: right;">*Factory setting</p> <p>Standard pipe connection Gas side: Standard diameter <input type="radio"/> ● ● ● ● ● ● ●</p> <p>Existing pipe connection · Gas side: Larger pipe <input type="radio"/> ● ● ● ● ● ● ● · Liquid side: No insulated</p> <p>Existing pipe connection · Gas side: Larger pipe <input type="radio"/> ● ● ● ● ● ● ● * · Liquid side: Insulated</p> <p>Existing pipe connection · Gas side: Standard diameter <input type="radio"/> ● ● ● ● ● ● ●</p>

In case of "Not insulated" (Setting# 1 or 3), the field settings for indoor units below are also required.

· Selection of thermistor → "Only remote controller thermistor".

If the above setting is not set, thermo-off indoor unit might exert heating capacity.

Caution: Failure to follow the instruction may lead to damage due to sweating and cause compressor damage and void warranty.

**Example: Automatic mode during cooling**

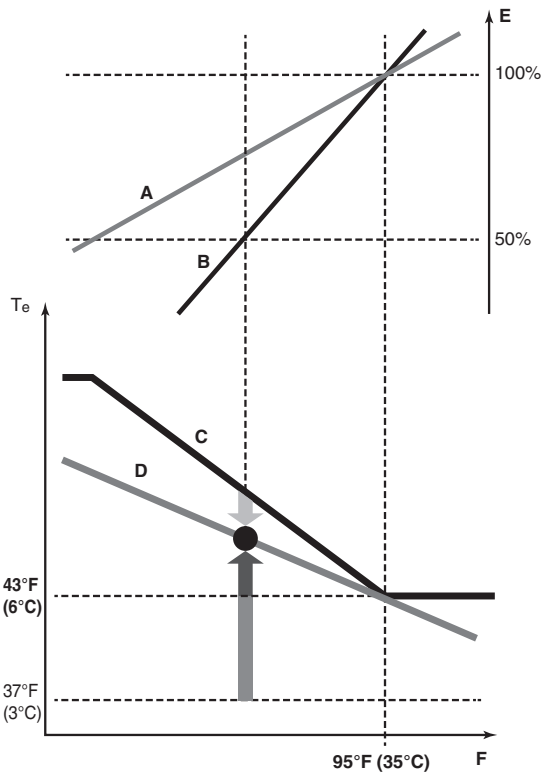

- A** Actual load curve
- B** Virtual load curve (initial capacity automatic mode)
- C** Virtual target value (initial evaporation temperature value automatic mode)
- D** Required evaporation temperature value
- E** Load factor
- F** Outside air temperature
- Te** Evaporating temperature
- Quick
- Powerful
- Mild

**Example: Automatic mode during heating**

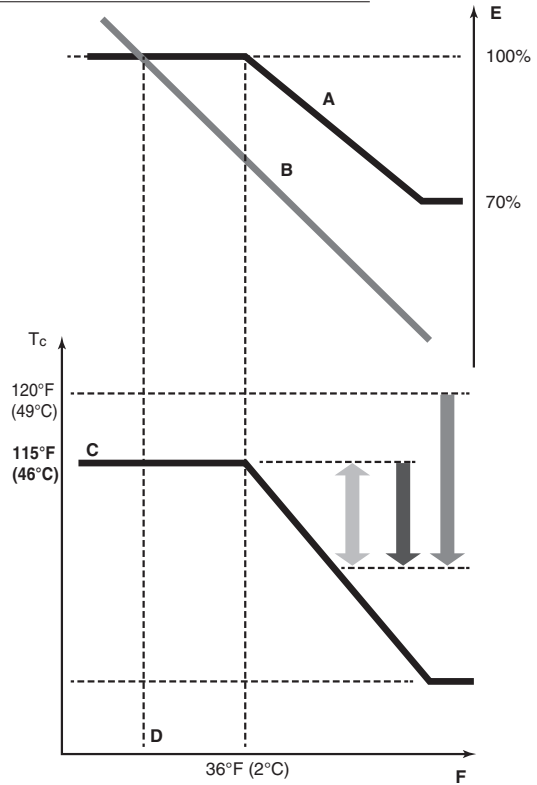

- A** Virtual load curve (default automatic mode peak capacity)
- B** Load curve
- C** Virtual target value (initial condensation temperature value automatic mode)
- D** Design temperature
- E** Load factor
- F** Outside air temperature
- Tc** Condensing temperature
- Quick
- Powerful
- Mild

**Room temperature evolution:**

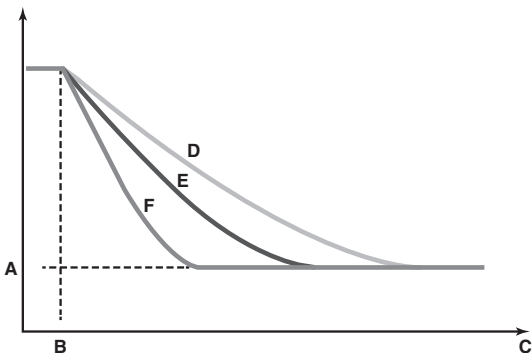

- A** Indoor unit set temperature
- B** Operation start
- C** Operating time
- D** Mild
- E** Quick
- F** Powerful

**Room temperature evolution:**

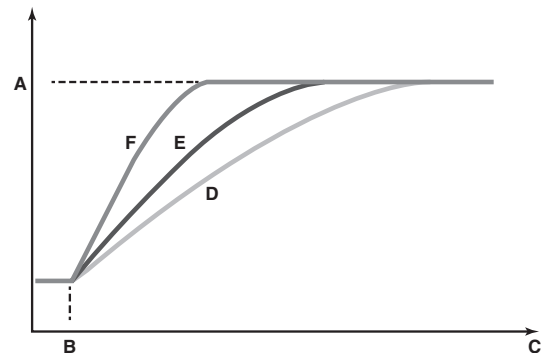

- A** Indoor unit set temperature
- B** Operation start
- C** Operating time
- D** Mild
- E** Quick
- F** Powerful



No matter which control is selected, variations on the behavior of the system are still possible due to protection controls to keep the unit operating under reliable conditions. The intentional target, however, is fixed and will be used to obtain the best balance between energy consumption and comfort, depending on the application type.

## 12. CAUTION FOR REFRIGERANT LEAKS

(Points to note in connection with refrigerant leaks)

### Introduction

**The installer and system specialist shall secure safety against leakage according to local regulations or standards. The following standards may be applicable if local regulations are not available.**

The VRV System, like other air conditioning systems, uses R410A as refrigerant. R410A itself is an entirely safe non-toxic, non-combustible refrigerant. Nevertheless care must be taken to ensure that air conditioning facilities are installed in a room which is sufficiently large. This assures that the maximum concentration level of refrigerant gas is not exceeded, in the unlikely event of major leak in the system and this in accordance to the local applicable regulations and standards.

### Maximum concentration level

The maximum charge of refrigerant and the calculation of the maximum concentration of refrigerant is directly related to the humanly occupied space in to which it could leak.

The unit of measurement of the concentration is lb./ft<sup>3</sup> ( the weight in lb. of the refrigerant gas in 1ft<sup>3</sup> volume of the occupied space).

Compliance to the local applicable regulations and standards for the maximum allowable concentration level is required.

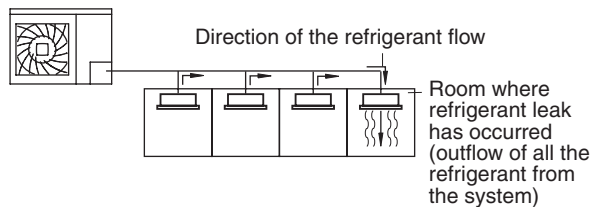

**Pay a special attention to the place, such as a basement, etc. where refrigerant can stay, since refrigerant is heavier than air.**

### Procedure for checking maximum concentration

Check the maximum concentration level in accordance with steps 1 to 4 below and take whatever action is necessary to comply.

1. Calculate the amount of refrigerant (lb.) charged to each system separately.

amount of refrigerant in a single unit system (amount of refrigerant with which the system is charged before leaving the factory)	+	additional charging amount (amount of refrigerant added locally in accordance with the length or diameter of the refrigerant piping and type of indoor unit)	=	total amount of refrigerant (lb.) in the system
---	---	--	---	---

### NOTE

- Where a single refrigerant facility is divided into 2 entirely independent refrigerant systems then use the amount of refrigerant with which each separate system is charged.
2. Calculate the smallest room volume (ft<sup>3</sup>)  
In case like the following, calculate the volume of (A), (B) as a single room or as the smallest room.

### A. Where there are no smaller room divisions

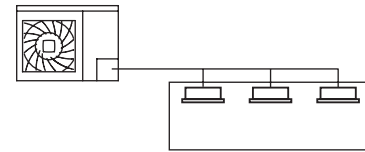

### B. Where there is a room division but there is an opening between the rooms sufficiently large to permit a free flow of air back and forth.

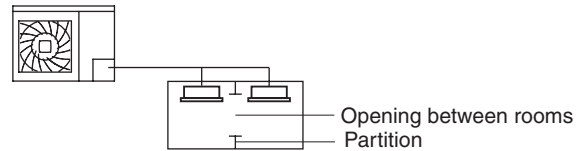

(Where there is an opening without a door or where there are openings above and below the door which are each equivalent in size to 0.15% or more of the floor area.)

3. Calculating the refrigerant density using the results of the calculations in steps 1 and 2 above.

$$\frac{\text{total volume of refrigerant in the refrigerant system}}{\text{size (ft}^3\text{) of smallest room in which there is an indoor unit installed}} \leq \text{maximum concentration level (lb./ft}^3\text{)}$$

If the result of the above calculation exceeds the maximum concentration level then make similar calculations for the second then third smallest room and so until the result falls short of the maximum concentration.

4. Dealing with the situations where the result exceeds the maximum concentration level.

Where the installation of a facility results in a concentration in excess of the maximum concentration level then it will be necessary to revise the system.

Please consult your Daikin supplier.

**DAIKIN COMFORT TECHNOLOGIES MANUFACTURING, L.P.**

Daikin Texas Technology Park,  
19001 Kermier Road,  
Waller, TX, 77484, U.S.A.

